

YUPITERU

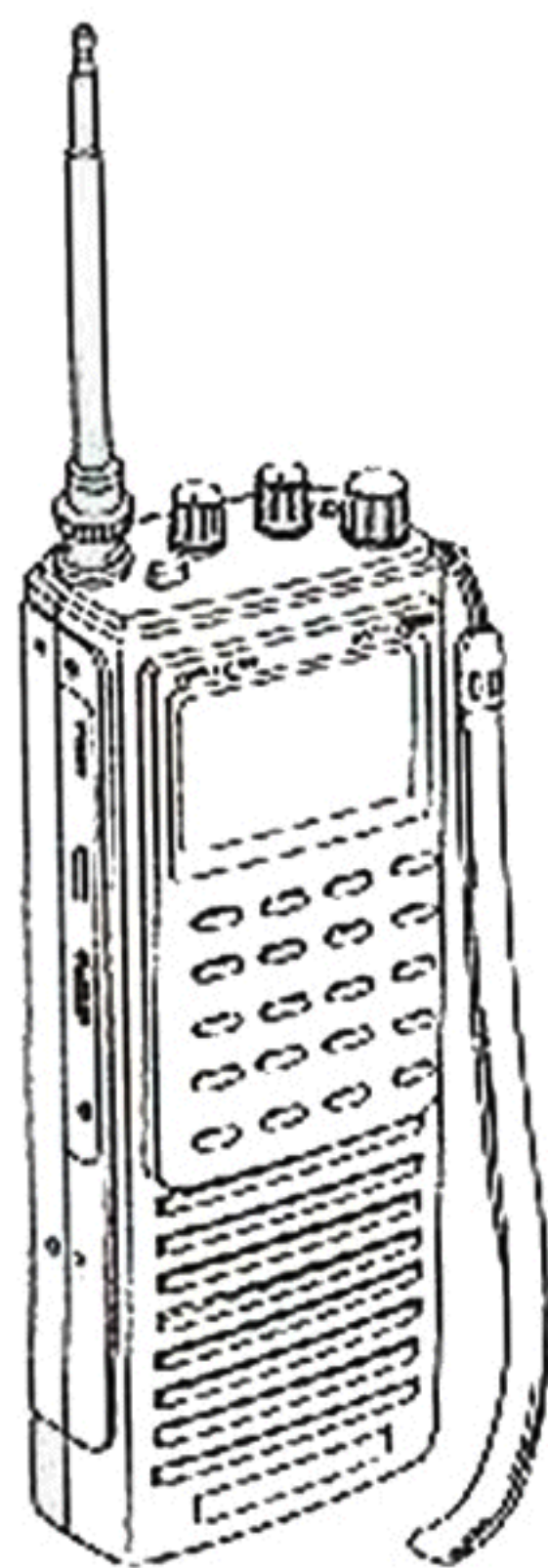

WIDEBAND SCANNING RECEIVER

MVT-7000

OPERATING MANUAL.

8MHz 1300MHz MULTIBAND RECEIVER
MVT-7000 INSTRUCTION MANUAL :

Thank you for your purchase of "YUPITERO" Multiband Receiver, MVT-7000.
To enjoy this unit for a long time, please read the manual carefully
and use this unit correctly.

CONTENTS:

- Chapter 1. Check and preparation before use
Main Features
Accessories
Cautions for operation
Controls and their Functions
Power Supply
- Chapter 2. Basic Operation
Before Control with Key
Tuning with Numeric Keys
Tuning with Tuning Dial
Search Function
- Chapter 3. Memories and scanning
Programming Memories
Calling Memory Channel
Scanning Memory Channel
Scanning Memory Banks
Program Scanning
Priority
- Chapter 4. Useful Functions
Changing Memory Data of Search Band
Skip Function
Delay function
Pass for Non-Modulation
Again function
Battery Save function
Eliminating of Beep sound
- Chapter 5. General Information
After Service
General Specifications

- CHAPTER 1. CHECK AND PREPARATION BEFORE USE
- Main Features
Accessories
Cautions for operation
Controls and their Functions:
o Main Body
o Display
o Key-board
- Power Supply
o How to charge the batteries built-in
o About the batteries

MAIN FEATURES:

* Comprehensive Control Facilities

The unit uses microcomputer technology to control all the functions. The receiver can be used as a simple direct entry or electronically tuned unit. More advanced user can make use of its many additional functions.

* The frequency from 8MHz to 130MHz are fully covered without any blank frequency range with wave mode of WFM, NFM and AM.

The wide frequency range, 8MHz - 130MHz, is guaranteed. The receiving mode can be freely selected from Wide FM (WFM), Narrow FM(NFM) and AM.

* Tuning Dial is also provided

In addition to the direct key entry for tuning, the dial tuning is also available.

* Many Frequency Steps

The frequency step can be selected in the range of steps of 5, 10, 12.5, 25, 50 and 100KHz.

* 10 Programmable Bands

You may pre-programme in to the receiver up to 10 separate bands, each with its own upper or lower limits, frequency steps and modes. You can instantly select any one of these bands and carry out a search.

* 200 Memory Channels

The receiver has 200 memories in 10 banks of 20. Each bank can be individually selected when using the scan mode. (Maximum 4 banks can be programmed at a time.) AM & FM modes can be mixed. Any combination of banks may be selected. Manual selection of any channel is also possible by direct key entry and manual up/down control in channel numbers is also possible.

* 2 (3) Power Sources

The receiver can be run directly from 4 AA dry cells or Ni-Cad equivalents. An external 12 Volt source can also be used for direct operation or to charge Ni Cads. NEVER USE 12 VOLT SOURCE WHEN DRY CELLS ARE IN USE.

* Plenty Receiving Functions and Operational Functions

- o "Pass-Memory" Function
- o "GAIN" Function
- o "Pass for Non-Modulation" Function (Audio or Carrier Wave Search)
- o Signal Meter
- o Adjustment of the Display Contrast
- o "ON/OFF" Function for Key-Touch Sound
- o Key-Lock Switch

ACCESSORIES:

Rod Antenna	(1)	Mounting Screws for Belt-Clip	(2)
AC Adapter(AC100V)	(1)	Car-Phone	(1)
Car Connector(Cigarette Lighter Plug)	(1)	Instructions	(1)
Ni-Cad. Batteries (Duilt-In)	(1)	Guarantee Card	(1)
Hand-Strap	(1)		
Belt-Clip	(1)		

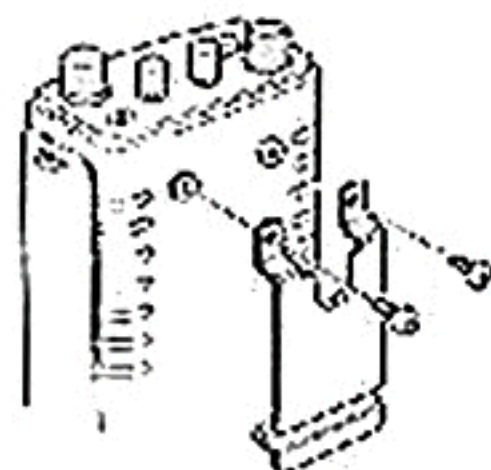
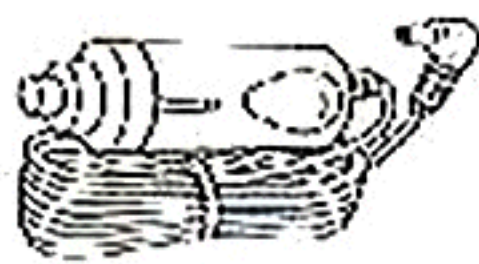
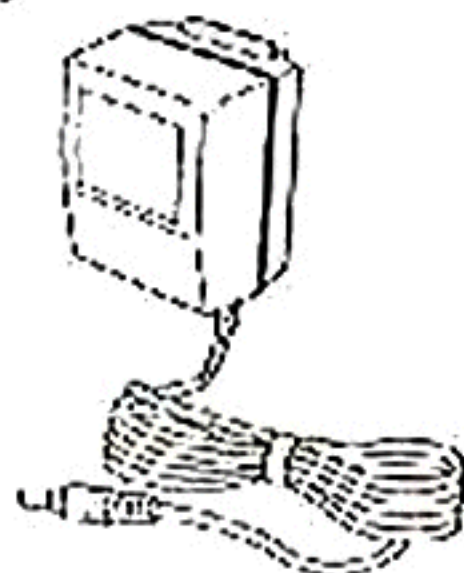

CAUTIONS FOR OPERATION:

* Be sure the unit is properly located.

- o It should not be located in a place directly exposed to sunlight or with excessively high humidity. (When the temperature is higher than 60 C, the LCD display may become dark and black. But, the temperature come to lower, the display also come back to normal condition.)
- o A noise may come into the receiver when using the unit near by a radio and TV set.

* About Handling

- o When taking out the unit, please be sure not to add the strong shock to the unit with dropping down.
- o When the unit has a stain on the unit, please wipe it out with soft cloth. Please do not use chemical cloth, polyester and cleaner which make electrostatical problems easily.
- o As the unit is the wide range receiver, there may be possible to have the frequencies generating some noise and unable to receive by an oscillation inside of the unit. (Spurious).

* For Safety

- o Do not connect or disconnect the power plug with wet hand.
- o Do not bend the cord by force and put the heavy goods onto the cable.
- o Do not touch inside and put something metals and etc. into the unit.

* About Antenna

- o The accessory antenna is usable for the short distance wave and strong wave signal. Please adjust the antenna to have optimum receiving condition. To receive long distance wave signal or weak wave signals, other external antenna optionally available is also recommendable to use.
- o Be careful about possible inter-modulation if there is a strong wave signal transmitted by broadcast station near to the receiver. By this reason, please do not use the antenna provided with Receiving Amplifiers.

* Reset Switch

- o Push the Reset Switch with a tip of ball-point pen when you have the following conditions.
 - o When you use it at first, after purchasing.
 - o When you want to erase all stored information.
 - o When the battery has no power completely.

* After service

The unit is precise electronic instruments. Do not disassemble it. When you have a problem, please ask for the repairing to the shop you bought the unit or our sales office.

CONTROLS & THEIR FUNCTIONS:

MAIN UNIT

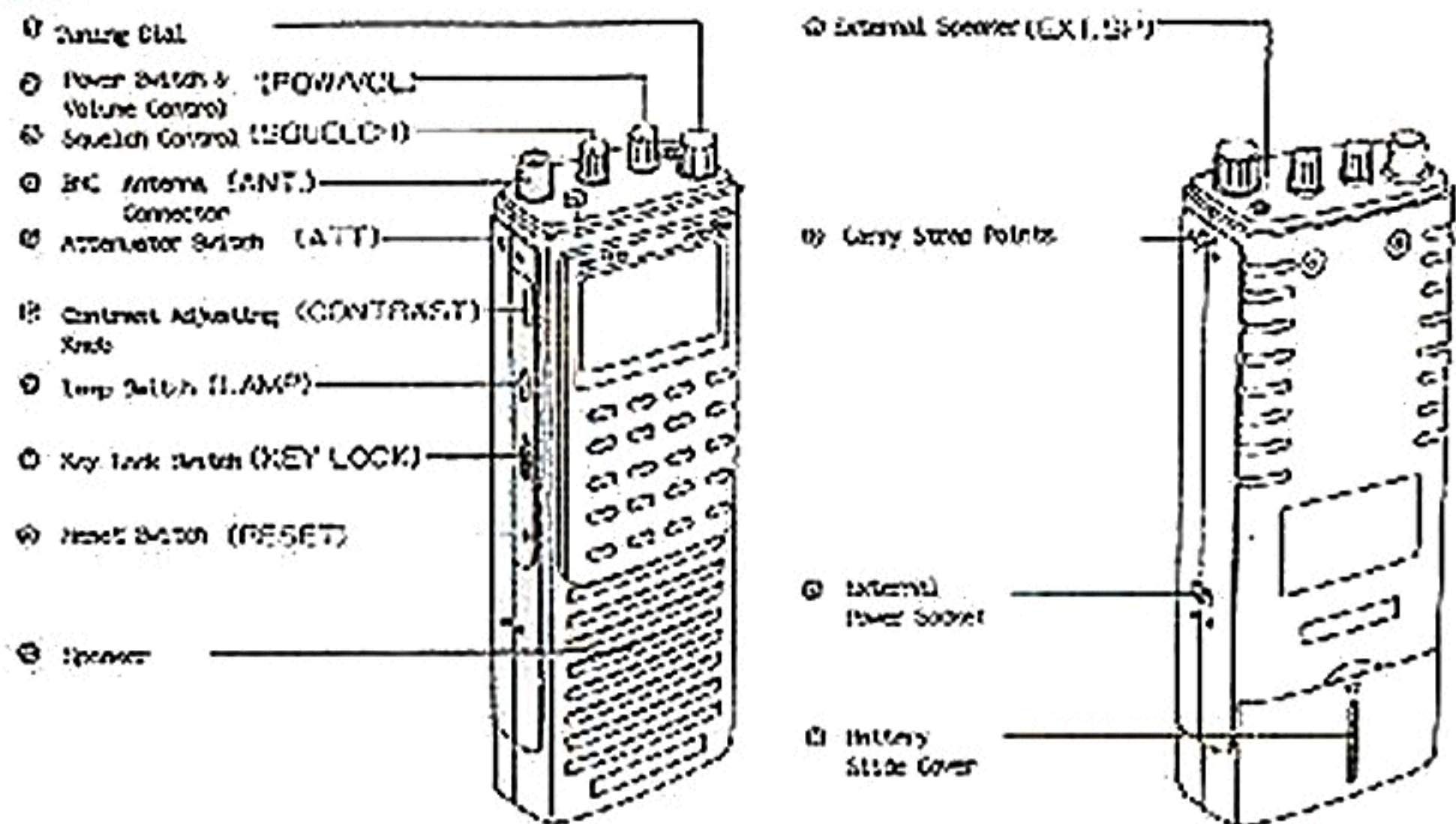

- (1) TUNING DIAL : The frequency can be set. The call channel can be changed.
- (2) POWER/VOLUME ADJUSTING KNOB "POW/VOL": Turn it to the right (clockwise) to turn the power "ON" and increase the sound volume.
- (3) SQUELCH ADJUSTMENT KNOB "SQUELCH": Use the knob to eliminate the "Zaaa" noise at Non-Signal. Use the knob to receive the signal at the optimum receiving condition.
- (4) ANTENNA CONNECTING TERMINAL "ANT": The terminal to be connected with antenna.
- (5) ATTENUATOR SWITCH "ATT": When the receiver has strong wave signals like a wave signal from broadcasting station, and had effect of noise and inter modulation by strong signals, turn the switch "ON". But, normally, use the unit with this switch at "OFF" position.
- (6) CONTRAST ADJUSTING KNOB "CONTRAST": Use the knob to adjust the brightness of the display panel.
- (7) LAMP SWITCH "LAMP": The Lamp Switch for display panel in the night. The lamp lights up while keeping it pushed.
- (8) KEY LOCK SWITCH "KEY LOCK": Turn the switch "ON" to make each key and tuning dial locked. It prevents from mis-operations. Use it when you carry it in hand. When keyboard operation, please check the switch at OFF position.
- (9) RESET SWITCH "RESET": The switch to set the micro-computer to initial condition.
- (10) SPEAKER
- (11) EXTERNAL SPEAKER TERMINAL. "EXT.SP" : The terminal to be connected with external speaker and ear-phone. When connecting with this terminal, the built-in speaker does not sound out.
- (12) CARRY STRAP POINTS
- (13) EXTERNAL POWER SOCKET. : With set switches off, the socket may be used for direct charging of Ni-Cads from 12 Volts. With set switched on, same source will directly run receiver. NEVER USE THIS WHEN BAY CELLS ARE IN USE !!
- (14) BATTERY SLIDE COVER

DISPLAY

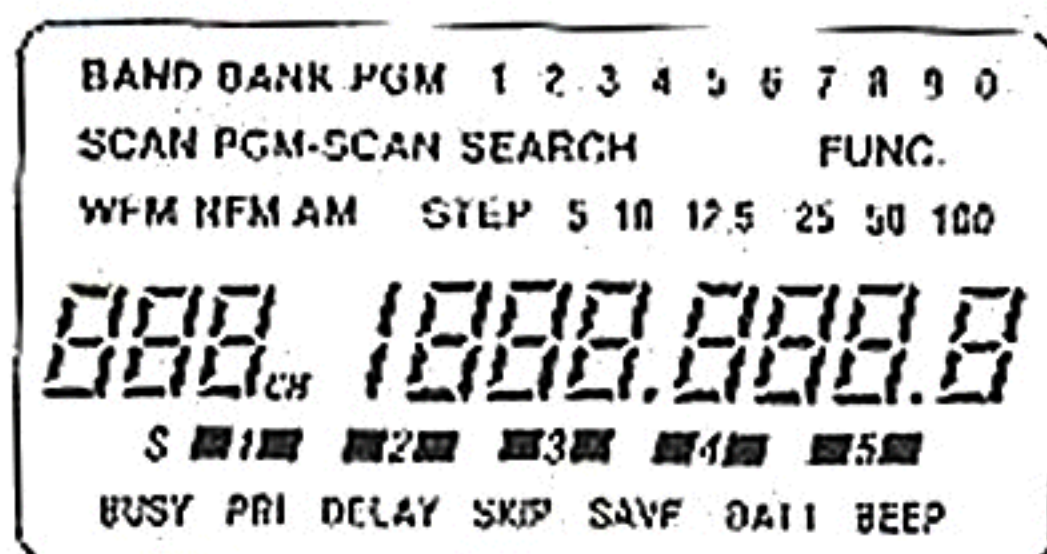

FUNC

It lights up when pushing function key.

WFM NFM AM

It shows the Receiving Mode selected.

STEP 5 - 100

It indicates the Frequency Step selected.

88.8

It indicates the memory channel and lights up at Calling the Memory. When you call the channel under "PASS-MEMORY", the "CH" indicator flickers.

9

It lights up at the receiving of Priority Channel, calling and programming the priority channel.

100.0000

It indicates the frequency and a figure in the input at each mode. On halfway of input process, the figures on the display flicker. After finish of input, it lights up. Also indicate the condition of unit like ERROR, ALL PASS, SLEEP.

SCAN

It lights up at Memory Scan. Mode and it flickers when the "Audio or Carrier Wave Search" function is in operation.

PGM-SCAN

It lights up at Programming Scan Mode and it flickers when "Audio or Carrier Search" ("Non-Modulation Pass") function is working.

SEARCH

It lights up at Search Mode and it flickers when "Audio or Carrier Wave Search" ("Non-Modulation Pass") function is in operation.

BAND

It lights up at Band selection. It appears with "SEARCH" indication and Band Number selected.

BANK

It lights up in the Memory Scanning mode with other indications of "SCAN" and the Bank Number of channel memorized.

PGM

It lights up in the Program Scan. mode.

1~9.0

It shows the Bank Number at Memory Scan. mode, the Search Band Number at Search mode and in the Program Scan. mode.

S ■■■

It is the signal level meter. It lights up according to the condition of receiving signal level.

BUSY

It lights up at opening the Squelch.

PRI

It indicates the Priority Function activated.

DELAY

It indicates the Delay Function activated.

SKIP

It indicates Skip function activated.

SAVE

It lights up at working of battery save function.

BATT

It light up and indicates to change the battery or to charge the battery.

BEEP

It lights up when the unit is set to have key touch sounds.

KEYBOARD

Numeric Keys. "1-9, 0, ."

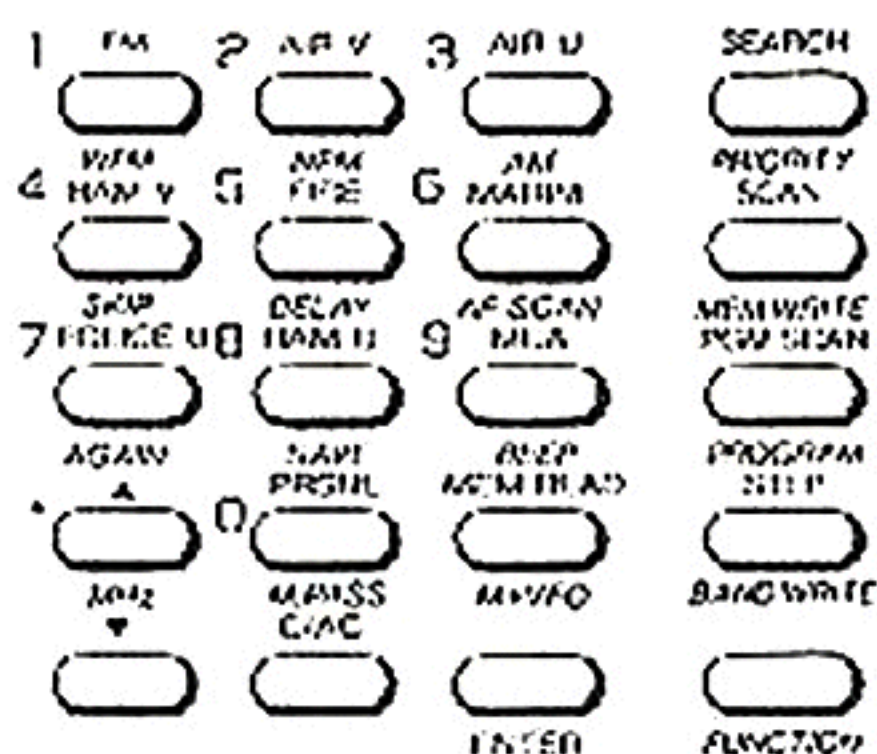

These are numbered "0-9" and are used for direct entry of frequency and memory channel. When starting Search, these are used for the key to select the search band.

Selection Keys for Band Search. "FM/ AIR V - PRSNI."

The selection key to select the band you want to receive. If you push the Search Key following to the Band Search mentioned above, the selected band search can be done.

FM: FM broad-casting	MARINE: Marine Boat
AIR V: Airband VHF	POLICE U: Police UHF
AIR U: Airband UHF	HAM U: Radio Amateur UHF
HAM V: Radio Amateur VHF	MCR: Commercial MCA
FIRE: Fire, Ambulance	PRSNI: Personal

Enter Key "ENTER"

Push after entering data.

Memory Read Key "MEM. READ"

This key permits the direct selection of a memory channel.

Clear/All Clear Key "C/AC"

In the middle of data entry of frequency or setting up the memory channel, this is used when data has been incorrectly entered. Push it one time for the condition to accept correction, then, correct the data by numeric keys or tuning dial. Push it 2 times for the condition of "ALL CLEAR". The data entered can be cancelled.

Up Key "▲" (Down Key "▼")

- o At Manual Receiving: Single push equals single step at the step frequency displayed on the indicator. Continually hold down, more than 1 second, for rapid frequency tuning.
- o At Calling Memory: Single push equals single channel step. Continually hold down, more than 1 second, for rapid channel tuning.
- o At Memory Scanning or Program Scanning: Single push gives a pause to scan. When scanning is at pause, single push equals single forced channel step. This control may also be used to change direction.
- o When Searching: Single push gives a pause to search. When searching is at pause, single push equals single step forced move of frequency. This control may also be used to change direction.
- o In the middle of data entry of frequency or setting up the memory channel, a push after a push of "C/AC" (Clear All) can give a move of a figure to be corrected. When correcting the frequency on the unit of "MHz" by the "MHz" key, a push give a move of the figure to be corrected.

Search Key "SEARCH"

Use this key to start searching of the "Search Band" entered or to start automatic searching without any frequency. Press this key to either start search or stop search.

Memory Scan Key "SCAN"

This control starts the scanning of memory channels. Select again to cancel operation.

Program Scan Key "PGM. SCAN"

This control starts the scanning of pre-programmed channels entered to "Program Scanning". Press this key to either start scanning or stop scanning.

Step Key "STEP"

Changes the frequency step. Press this key at manual mode or search mode, for selection of the frequency step of 5, 10, 12.5, 25, 50, 100kHz.

Function Key "FUNCTION"

Used to select secondary function of keys. Secondary functions are shown in the same colour as "FUNCTION" printed. (White Colour)

* Keys to follow the Function Key to perform the secondary function. *

Selection Key of Receiving Mode "WFM"/"NFM"/"AM"

used to select receiving modes, wide FM, Narrow FM and AM.

Skip Key "SKIP"

Normally scanning will stop as soon as a signal is found and will not resume again until the signal ceases. With "SKIP" selected the scanning will halt for 5 seconds before resuming. Press "SKIP" again to switch this mode off.

Delay Key "DELAY"

Used when in the Memory/Program scanning and Search mode the delay control provides a short delay when transmission ceases before resuming the search or scan operation. (Normally, 2 seconds before resuming but, with the control, it changes to 4 seconds before resuming.)

AF Scan Key "AF SCAN"

Used to prevent receiver from locking onto blank carriers when in the Memory Program scan or Search mode. After 3 seconds of finding a blank carrier the receiver resumes the Search/Scan mode.

Again Key "AGAIN"

Used to return to the channel just before when in the Scan of memory channel or Search mode.

Save Key "SAVE"

Selects the battery save circuit. It works only at manual receiving and the receiving by calling memory.

HOW TO CHARGE BATTERY BUILT-IN:

* Charge the battery built in by using the car connector provided (or AC adaptor.)

* The unit is provided with "AA" type (UM31 Ni-Cad batteries, 4 pieces.

1 Be sure to turn Power/Volume knob to "OFF" position.

2 Put the plug of car connector (or AC adaptor) into the external power socket.

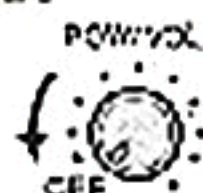

Beep Key "BEEP"

Used to delete the key touch sound.

MHz Key "MHz"

Use the control to move the frequency at the unit of "MHz" when in the manual receiving.

Memory Pass Key "M. PASS"

This control works with the scanning mode. Memorised channels can be excluded temporarily from each scan pass.

Memory VFO Key "M VFO"

Use this control to move the frequency entered in memory to the manual mode.

Priority Key "PRIORITY"

Used to work the priority function.

Memory Writing Key "MEM WRITE"

Used for writing frequencies into memory channels. Also usable for erase the data memorised in specified channels.

Enter Key for Program Scan "PROGRAM"

Use this control to enter the specified channel already entered into the channel in the Program Scanning. Also used to erase the data entered.

Band Writing Key "BAND WRITE"

Use this control for rewriting of the data in the "Search Band" memorised.

* This unit is useable with power sources of Ni-Cad battery built-in, AC Adaptor in home use and mobile use with car cigaret plug (connector).

3 Charge the batteries for 15 hours minimum. The receiver can be operated for 4 - 5 hours continuously in manual use. (Do not over-charge for many hours)

CAUTION: The car connector is only useable with 12V battery car.

* When charging, the power/volume switch should be at "OFF" position.

* Never use 12V source when dry cells in use!

Battery

CAUTIONS:

- * Please charge battery well in advance of discharging excessively.
- * Do not mix with different kind or old batteries for use.
- * Please be sure to turn the power/volume switch to "OFF" position when replacing the battery.
- * Please take out the battery when you do not use for long time.

* Replacement of Battery

1 Open the battery cover as shown on the sketch.

2 Check the (+)(-) of 4 batteries and insert them according to the sketch inside.

3 Close the battery cover.

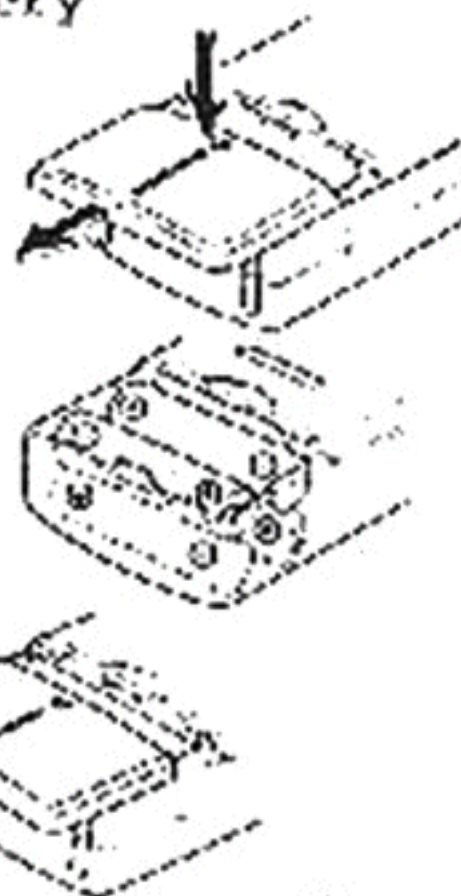

CHAPTER 2. BASIC OPERATION

Before Key Controls

Tuning with Numeric Keys

- o Input of Frequency 18
- o Selection of Frequency Step 20
- o Selection of Receiving Mode 20
- o Tuning up or down in steps, Rapid Tuning by keys 21
- o Correction of Input Frequency 22
- o "MHz" moving of Receiving Frequency 23

Selection of the station by using the tuning dial 24

Search Function 26

- o Basic Selection and Search 28
- o Pause and Selection of direction. 29
- o Continuous Search 30

Before Key Controls

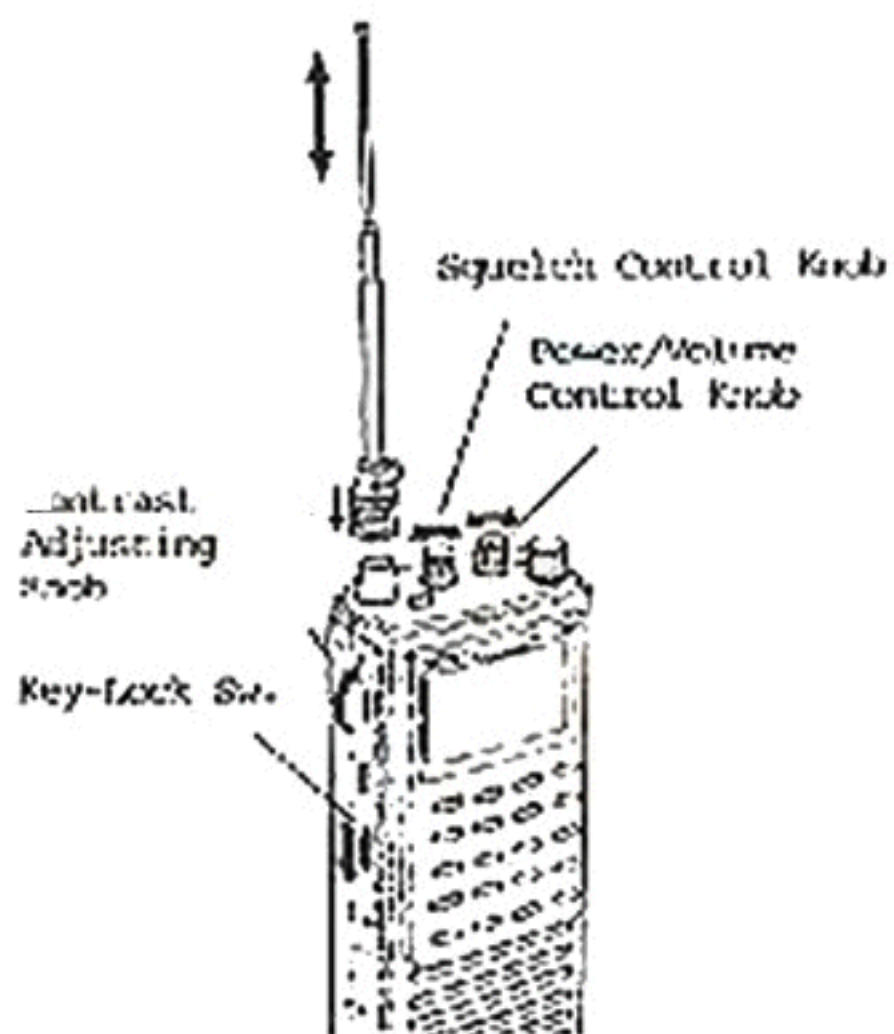

1 Insert the rod antenna provided into antenna connector and turn the antenna connector (BNC) to the clockwise 4 turns to fix antenna.

2 Adjust the length of rod antenna to get a better receiving condition. Extend it for lower frequency and shorten for higher frequency so you may tune easily.

3 Turn off the Key-Lock Switch.

4 Turn the Squelch Control Knob to the left to end.

5 Turn the Power/Volume knob to clockwise for power "ON". Then, the display indicates.

6 Adjust the brightness of display with Contrast adjusting knob.

7 Adjust the sound volume to have optimum level.

8 Adjust the Squelch Control knob to cut out background noise when no signal is being received. Turn to clockwise to position cutting out the noise. ("BUSY" Ind. goes out.) When the speaker sounds out voice, turn the knob to the middle position.

☞ * The frequency is displayed as 144.000.0 when pressing the Reset Switch and calling the initially entered data.



* When adjusting to cut out the background noise at no signal, the display "BUSY" goes out.

(CAUTIONS)

- * Check the display when power is turned on. When display indicates "BATT", change the batteries or charge batteries.
- * Squelch should be adjusted at optimum level to receive both weak and strong signals.

Input of Frequency (Entering a Frequency)

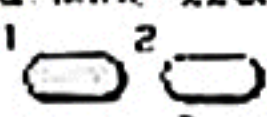
Selection of Frequency Step

- 1 Enter the frequency which you want from the high figure to low figure. 
- 2 Press the "ENTER" key and frequency display change from flicker to lighting. (The entering of frequency is achieved.) 
- 3 * If you try to enter a frequency beyond the receiver range, the display will show "ERROR" for 2 seconds and return to the frequency before your trying.
- * The receiver range is 8 - 1300MHz, but the frequency range 0.1-1300MHz can be entered.
- * When you enter the frequency which is not available for entering with frequency step on display, the frequency is forced to correct to the acceptable frequency to frequency step.
- * The entering by using keys should be done within 10 seconds after press of final key. After 10 seconds, the frequency will reset to the frequency just before entering.

- You may change the frequency step by pressing appropriate control noting the step display change. This may be 5, 10, 12.5, 25, 50 or 100kHz steps.
- When you start searching from the frequency indicated or, change the frequency, it is better to select the preferable frequency step in advance.
- The frequency step is indicated on display panel.

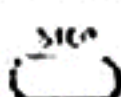
In the Manual mode or Search mode, press the "STEP" key until the display indicates the step you want over looking the display. 

- The frequency step in the Wide FM should be always 50 or 100kHz.
- In the Search Band Memory of this unit, appropriate wave mode to each band and frequency step are pre-programmed. (Refer to page 63)

Changing Mode

- In the Manual or Search Modes, the receiving mode can be selected.

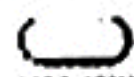
1 Press the "FUNCTION" key 

2 Follow the above, press the keys WFM, NFM or AM to select the preferable mode. 

Wave Mode

The receiving range of this unit covers radio amateur, commercial radio, Personal (Japanese) FM TV broadcasting, marine and airband etc. To receive these different wave modes, it is necessary to select not only frequency but also wave mode. Before receiving, select the mode.

WFM	FM Broadcasting	76-90 MHz
	TV Audio (1-3ch)	90-108
	TV Audio (4-12ch)	175-222
	TV Audio (UHF)	475-770
NFM	Radio Amateur	50-1300
	Marine Radio	156-162
	Personal Radio	903-405
AM	Airband (VHF)	108-142
	Airband (UHF)	272-330
	CB Radio	27-28

(EX) 81.3MHz would be keyed as follows. (FM)

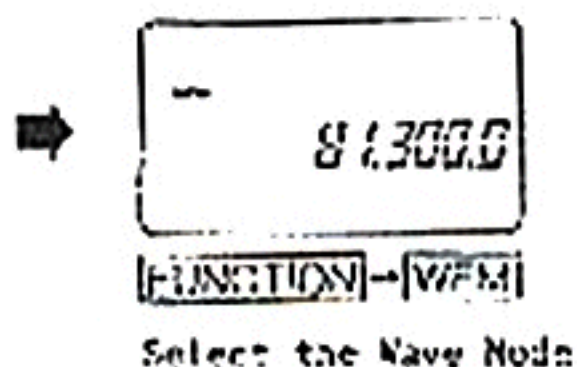
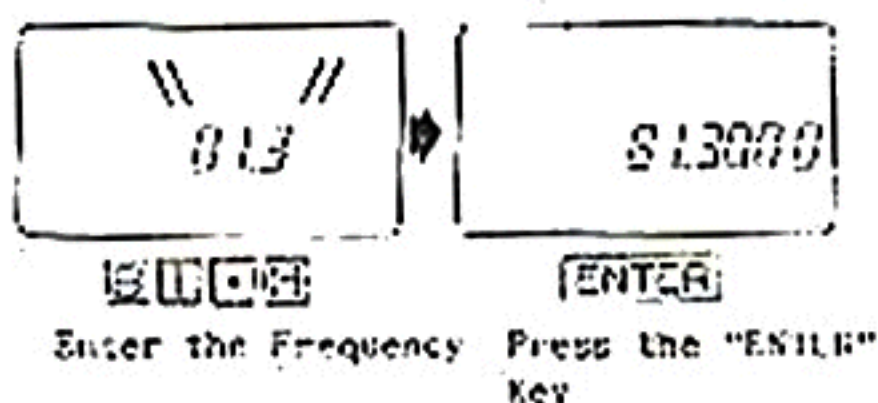

Moving Frequency by using of Δ , ∇ Keys: (Frequency Step, Rapid sending and return.)

- In the Manual mode, you can simply tune up or down the band in the selected frequency steps by pressing the Up/Down buttons. A short press will move the frequency up or down one step. If the control is held down for more than about a second, the receiver will tune rapidly up or down in the receiving frequency range.

Correction of Entering Frequency

- When you entered the frequency by mistake, you can correct the entering by pressing "Enter" key so try again from first, or, press the "C/AC" (clear/all clear) key a short time, then correct the frequency by using of numeric keys or tuning dial.

(caution) You cannot correct the entering frequency after a press of "Enter" key or press the "C/AC" (clear/all clear) key in two times. You must try to enter from start again or, adjust the frequency by moving the frequency up and down by step moving by using of Up/Down keys or tuning dial.

(EXAMPLE)

You want to enter the frequency 128.8MHz but, entered 126.8MHz by mistake.



Press clear/all clear a short time. The entered numbers flicker and the numeral to be corrected is flickering rapidly.

Select the figure to be corrected by Up key. After a short, press of "C/AC", press the up key and down key so that you can save the figure to be corrected.

Enter the correct numeral

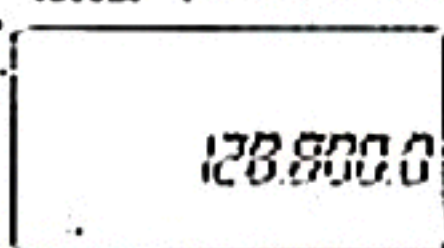

[ENTER]

Press the "ENTER" key

"MHz" Moving of Receiving Frequency

- In the Manual mode, press the "Function" key followed by "MHz" key, and the "MHz" can be moved by pressing of numeric keys or by using the tuning dial.

Enter the number you want to move by using of numeric keys or tuning dial.

- Select Manual mode.

- Press the "Function" key 

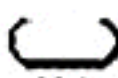
- Press the "MHz" key 

Press the "Enter" key to complete the entering. 

- When you want to move up or down at the unit of 10MHz or 100MHz, press the Up key 1 or 2 times so that the figure to be corrected can be moved up and down. 

- If you press the down key, the figure on flickering, will move down to lower figure (until 1 MHz figure).

(EXAMPLE) 194.0MHz would be keyed in as follows by using of "MHz" moving on the figure of 10MHz of the displayed frequency 144MHz.



Press the "FUNCTION" key followed by "MHz" key

Select the figure to be corrected by pressing of Up key.



Enter the correct numeral.

Press the "Enter" key

Tuning with Tuning Dial



- In the Manual mode, the frequency will be changed at the displayed frequency step by turning the Tuning Dial.

Select the Manual mode (The display does not show SEARCH, SCAN, PGM-SCAN and Memory Channel Number.)

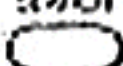
Cancellation of "Search" mode

Press the "Search" key 

Cancellation of Memory Scan Mode

Press the "Scan" key  followed by "Mem. Read"  (Memory Read) key.

Cancellation of Program Scan Mode

Press the "PGM. SCAN"  (Program Scan) key

Cancellation of Calling Memory Mode

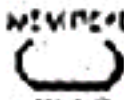
Press the "MEM. READ"  (Memory Read) key or move the frequency of memory channel to Manual mode by using of key.

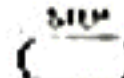
2 Select the frequency step. 

3 Select the Receiving Mode.

4 After all the above selections, turn the Tuning Dial. The frequency will change at the step displayed.



The present display

Turn the Tuning dial to clockwise, the frequency moves up at the frequency step and wave mode displayed.

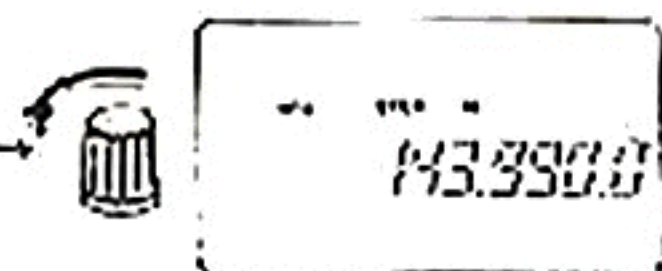

Turn the Tuning dial to anti-clockwise, the frequency moves down at the frequency step and wave mode displayed.

- The wave has a little bit allowance (Possessive Frequency Range Width). In the range, the wave can be received though it may not be a correct frequency.

If you select the wide frequency step you may not catch the correct frequency. It is recommendable to select narrow step for tuning. And, it is easy to check the wave signal condition if you look at the signal meter on the display.

The receiving signal is strong
S 

The signal is weak.
S 

Band Selection and Search

- The receiver comes with 10 pre-programmed bands for the purpose of band searching.

When the user does not have frequency he wants to receive, he can instantly select any one these band and carry out a search.

- 1 Turn the Squelch Adjusting knob to cut out the background noise. 

- 2 Press the band selecting key of preferable receiving band. 

- 3 Press the "Search" key to start tuning automatically. In this time the LCD display indicates either "SEARCH" or "BAND", 1 - 9.0. 

- 4 The data shown on the page 63 (Japanese Instruction) are pre-programmed in the FM, AIR V - PRSNL of Search Band Selecting keys.

To start to search a band, press band of your choice followed by "Search". The receiver will start to search for signals. As soon as a signal is found, the search will stop. The signal is gone out, the search will resume.

The data stored in 10 bands may be modified by user in the same manner as shown in the "Changing of Memory Data". (Refer to page 56 of Japanese instruction.)

In searching band, mode and frequency step can be modified. (But in this unit, these data are pre-programmed on each band. See page 63)

In searching, press again "Search" key for cancelling the search mode.

(EXAMPLE)

The user wants to receive Air-Band

(AIR-VHF)

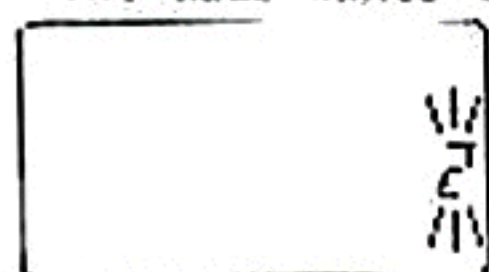

[AIR V]

Press the "AIR V" key

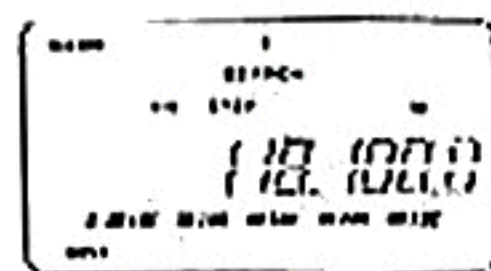

[SEARCH]

As soon as "SEARCH" is displayed, the frequency will start to move and search signals. As soon as a signal is found, the search will stop to receive.

(EXAMPLE) In case the search starts from displayed frequency.

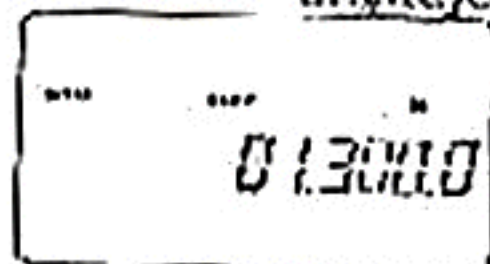

Present Display

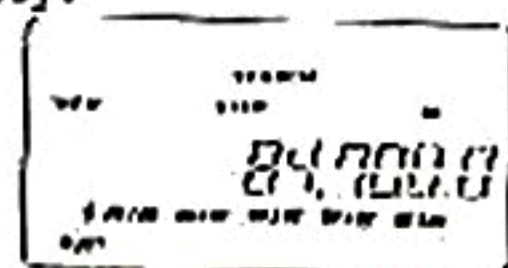

[SEARCH]

Pressing "Search" key will begin a search automatically at the frequency step displayed. As soon as signal is found, the search will stop.

Pause and Selection of Direction

- Press the Up/Down controls while searching. The searching will pause for a second to wait for receiving signals at the displayed frequency. If the receiver cannot receive signals while waiting, the receiver will start to search for signals again.

■ SELECTION OF DIRECTION

Pressing the Up/Down controls while searching is in pause will change the frequency 1 step and select the search direction in a subsequent searching.

Continuous Search

- When user does not know the frequency clearly, the receiver will search automatically from displayed frequency with displayed wave mode and frequency step in the range of receiving frequency of the receiver.

- 1 Turn the Squelch control knob to cut out the background noise.

SQUELCH



- 2 Select the wave mode and frequency step in advance.

- 3 Pressing the "Search" will begin a search automatically.



- 4 Pressing the "Search" button will begin a search from the frequency displayed to upwards with frequency step and mode displayed in the receiving range.

CHAPTER 3 MEMORIES & SCANNING

Programming Memories	34
o Selection of Channel and Entering Memories	34
o Continuous Memory	36
Calling Memory Channel	38
o Calling of Memoried Channel	38
o Moving of Channel	39
o Moving to Manual Mode	40
o Programming of Pass Memory	41
o Eliminating of Memory Channel	42
Scanning Memory Channels	44
o Programming of memory channel scanning	44
o Pause and Selection of Direction	45
Scanning Memory Banks	46
o Programming of Bank Scan	46
Program Scanning	48
o Entering of Program Scan	48
o Programming the Program Scan	50
o Pause & Selection of Direction	51
Priority	52
o Entering Priority Channel	52
o Programming of receiving of Priority Channel	54
(How to receive priority channel)	

Channel Selection and Entering Memory - Programming Memories

There are 200 memories in the unit, and these are split into 10 banks of 20 each. Each bank can be scanned individually or any number of banks can be selected to be scanned consecutively. (Bank Scan: Refer page 46)

1 Enter the frequency to receive and select the wave mode.

2 Select a chosen memory channel (1ch - 200ch) by numeric keys. While selecting, the numerals displayed will flicker.

3 Press the "Function" key.



5 Press the "MEM. WRITE" (Memory write) key. The programming is completed if the receiver sounds out the beep sound (pip, pip)



6 The memory is entered at the displayed wave mode and frequency step.

When entering over than 200ch the display shows "ERROR" for 2 seconds and returns to the condition before key controls.

When entering new memory data into the channel already memorized, the previous memory data will be rewritten by new memory data.

The entering to "0 ch" equals the entering of Priority Channel. (Refer page 52, in Japanese)

(EXAMPLE) 178.8MHz (Airband) to be stored into Channel "13".

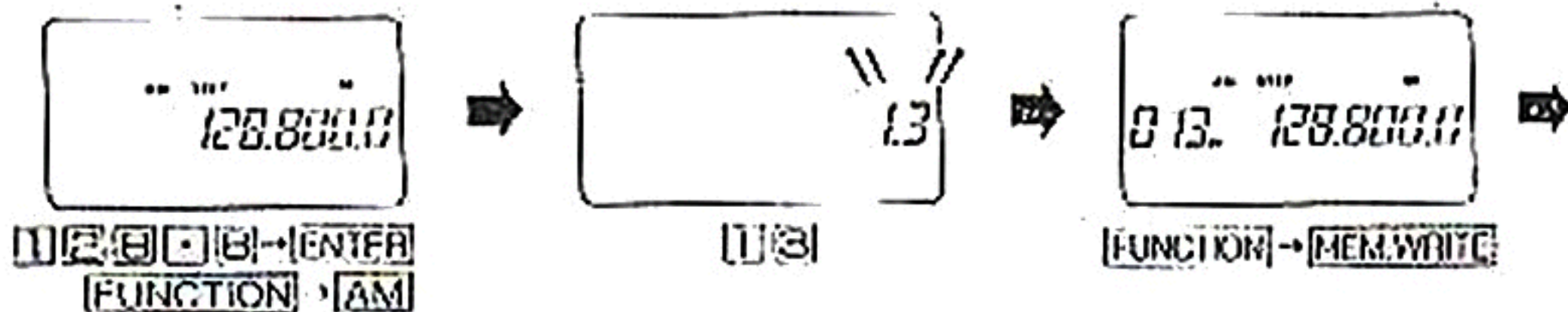

Enter the frequency and select wave mode

Select the memory channel

The entering is completed.

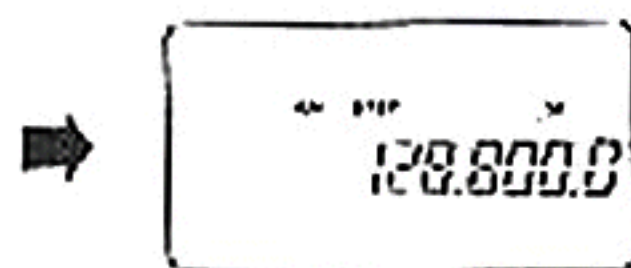

1 second after, the display of channel number will disappear and only frequency remains on the display.

Continuous Writing of Memories

In Manual mode or Search halt, the continuous writing memories can be done without entering memory channel.

1 Enter the frequency to receive and select wave mode.

2 Press the "Function" key



3 Press the "MEM. WRITE".

The beep sound, pip pip inform of finish of entering.



6 The memory is done from the channel finally called.

When calling memory after channel memory, the channel added 1 channel to finally memorized channel will be called.

When receiving a frequency, the frequency can be memorized with displayed wave mode without any selection of frequency and wave mode.

(EXAMPLE) Search the Airband (AIR V) and memorize the stations continuously

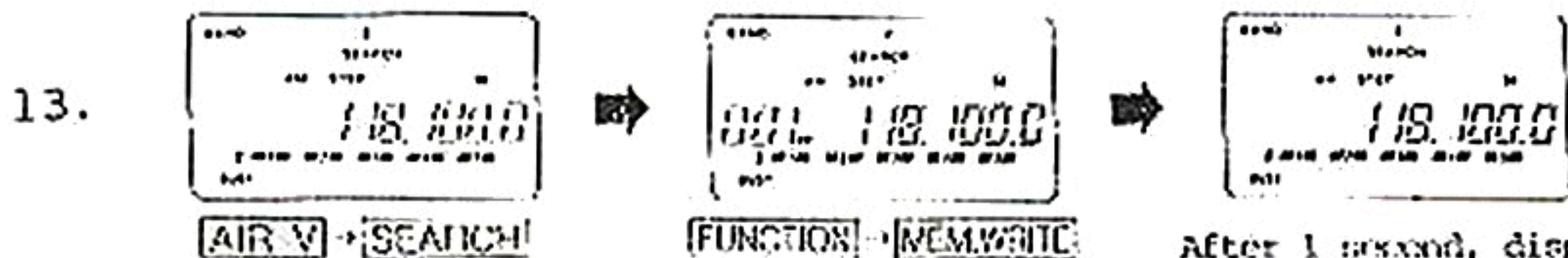



13.

Receive in "AIR V" search. Entering is completed

After 1 second, display of channel No. will disappear and return to search mode.

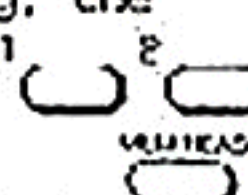
Calling Memory Channel

- 1 Select the calling channel by pressing numeric keys. While selecting, the numeral on display flickers. 
- 2 Press the "MEM.READ" key. 
- 3 Pressing "MEM.READ" Key without selecting the Channel calls the last channel which was called in before.
- 4 The channel not numbered in the channels from 1ch to 200ch can also be called. But, display indicates frequency as "000.000.0"
- 5 Calling the "0 ch" equals the calling "Priority" channel.
- 6 When calling the memory channel over than 201ch, the display indicates "ERROR" for 2 seconds and returns to the condition before mis-controls.
- 7 While calling a memory, pressing "MEM.READ" again will return to manual mode receiving which is the receiving condition before calling the memory.

When calling the channel on "Pass-Memory", the display "CH" will flicker.

(EXAMPLE) Calling 128.8MHz stored in the Channel "13 ch".

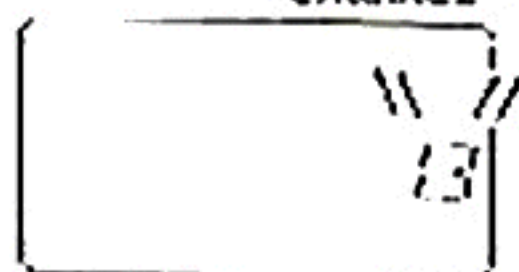

[1][3]

Select the memory channel

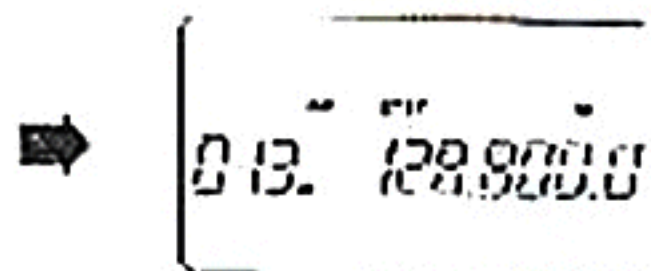



[MEM.READ]

Complete calling.

Moving of Channel

- 1 After memory calling, pressing the Up/Down controls or turn of tuning dial equals single channel up or down. Continuously hold down, more than 1 second, for rapid channel moving between 1ch and 200ch.

Moving to Manual Mode

- 1 The frequency in the memory channel can be moved to MANUAL (VFO) mode.
- 1 Call the preferable memory channel.
- 2 Press the "Function" key. 
- 3 Pressing the Memory VFO key "M VFO" completes the operation. 

- 4 The frequency step and wave mode in memory channel will be moved.

(EXAMPLE) Move the 128.8MHz stored in 13ch. to MANUAL mode.

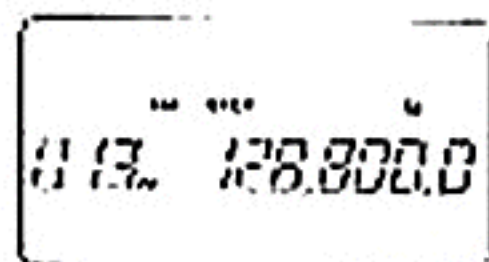

[1][3] → [MEM.READ]

Call the memory channel

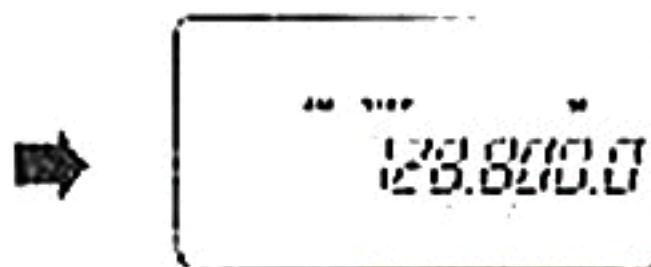

[FUNCTION] → [M VFO]

Move to MANUAL mode.

Programming of Pass-Memory

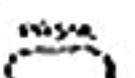
- 1 After calling memory or while receiving signals in scan mode, entering "Pass-Memory" works not to receive the channel in the scan mode subsequently.
- 1 Call the channel you want to make "Pass-Memory".
- 2 Press the "Function" key 
- 3 Press the "M.PASS" (Memory Pass) key 
- 4 While receiving in the Scan mode (under Scan Hall), the exhibition is the calling of Memory Channel.

- 5 After calling the memory, again, pressing "Function" and "M.PASS" controls cancel the "PASS-MEMORY" ("Memory-Pass").

- 6 In the channel without memory channel the "Pass-Memory" programming will not be accepted.

- 7 The "Pass-Memory" channel is indicated by flickering of "CH" of channel No. when calling the memory.

- 8 The Priority Channel is not available for entering into "PASS MEMORY".

Programming of Pass-Memory

(EXAMPLE) Erase the Data Stored in "13ch"

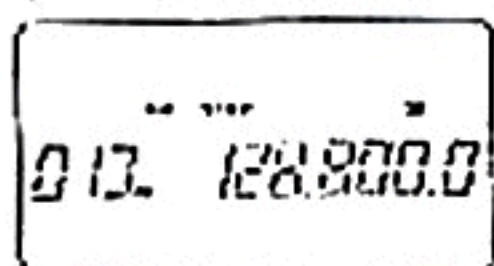

[1][3] → [MEM READ]

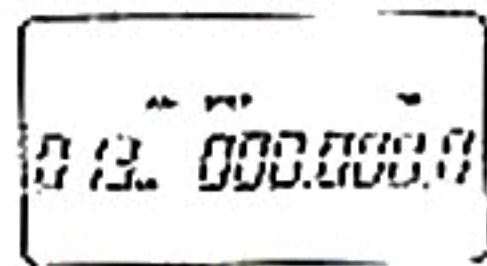

Call the channel memoried.



[FUNCTION] → [MEMWRITE]

Erasing the data is completed.

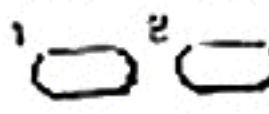
Erasing the Data in Memory Channel

- 1 Call the memory channel to be erased. 
- 2 Press the "Function" key 
- 3 Pressing the "MEM. WRITE" (Memory Writing) key complete the operation. 

- Erasing the memory channel data displays the frequency as "000.000.0".

While receiving the frequency in memory channel, the erasing does not stop receiving though the data is erased.

The above controls are not able to erase the data memoried in "priority" channel.

(EXAMPLE) Entering the frequency stored in "13ch" into "PASS-MEMORY" and pass it from Scan.

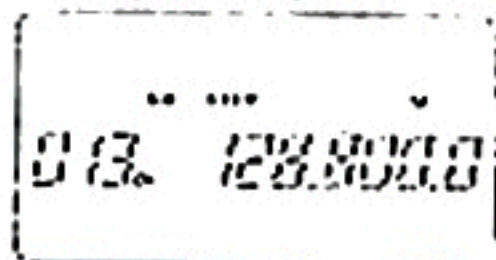

[1][3] → [MEM READ]

Call Memory Channel

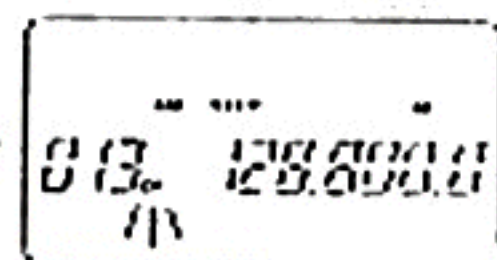



[FUNCTION] → [M.PASS]

Pass-Memory of 13ch is completed.

Scanning Memory Channels

- Press "SCAN" key and receiver will begin to scan the channels memoried. (from 1ch to 200ch). The scanning will halt at the signals to receive. After going out the signals, the scanning will resume.

- 1 Adjust the Squelch Control to cut out background noise. 

- 2 Pressing "Scan" key starts scanning to select signals. Then, display shows "SCAN" and "BANK NO." memoried. The bank number on receiving will flicker on display. 

- Pressing "SCAN" key again cancels the Scan mode.

- Only the channels memoried can be scanned.

- When all of the memoried channel have "PASS-MEMORY" controls, the display shows "ALL PASS" and the receiver cannot enter the scan mode.

(EXAMPLE) Scan the Channels memoried.

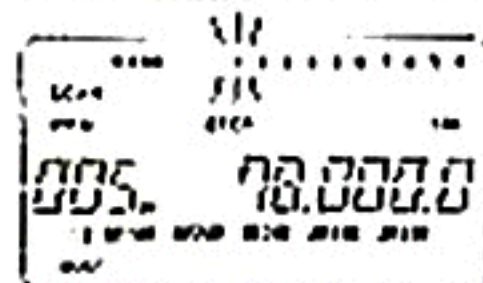

[SCAN]

Press "Scan" Key.
Display shows "SCAN" and Scan of memory channel will start to receive signals.

Pause & Selection of Direction

- Pause**
While scanning, pressing Up/Down keys stops scanning and the receiver will wait for signals at the frequency displayed for a second.

- Selection of Direction**
While stopping scanning, pressing Up/Down controls will change the frequency 1 step and select the scan direction in a subsequent scanning.

- The tuning dial operation will be not effective while moving channels.
- While receiving, stopping scanning, turn of tuning dial will move 1 step of channel and keep the scanning mode.

Programming Bank Scan

- There are 200 memory channels in the unit and these are split into 10 banks of 20 each. Any number of banks can be selected to be scanned consecutively by selecting numeric keys before pressing "Scan" key.

- 1 Adjust the Squelch Control to cut out background noise. 

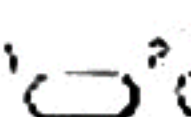
- 2 Select the bank to be scanned by numeric keys. Maximum 4 banks can be programmed to scan. The display shows the flickering numeral of banks to be scanned. 

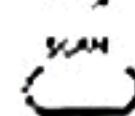
- 3 Pressing "Scan" key will start scanning of the banks. 

(7) The relation of Bank No. & Memory Channel.

Bank No. (BANK)	1	2	9	0
Memory Chan.(ch)	1-20	21-30	101-110	181-200

o The bank scanning selected by keys will be cancelled in the next other next.

- o When all channels selected to bank scan have "Pass-Memory" controls the display shows "ALL PASS" for 2 seconds and return to receiving condition just before selection.
- o Only the bank memoried can accept the selection of bank scanning.

(EXAMPLE) Among 10 memoried banks, scan the Bank No. 1(1-20ch) Bank #3(41-60ch) and Bank #0(181-200ch) only.

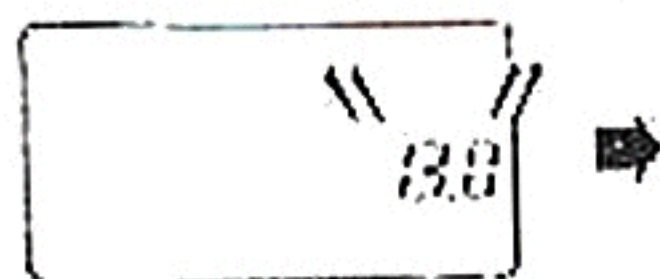

1 3 0

Select the bank.



Pressing the "Scan" key starts scanning selected. Then, display shows the bank number 1, 3, 0 and the present bank will flicker when receiving the signal.

Entering Program Scan

■ The unit has program scan function to scan any 10 channels memoried.

o The next entering will start from the cancelled program number consecutively.

1 Call the channel to be entered to Program scanning.

2 Press the "Function" key 

(EXAMPLE) Enter the 78MHz(WFM Mode) memoried in "5ch" into the Program Scanning.

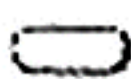
3 Press the "Program" key. The entering is completed with beep sound, pip, pip. 

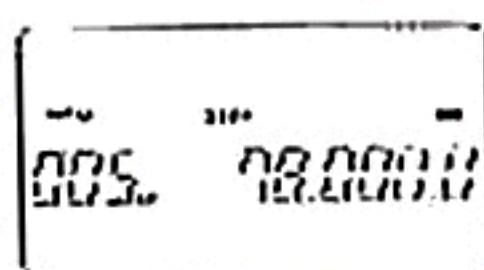

[5] → [MEM. READ]

Call the channel memoried.

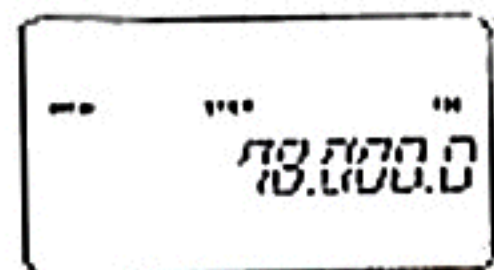

[FUNCTION] → [PROGRAM]

Entering to program scan is completed.

o To check the data entered into the program scanning, select the program scan mode and open the Squelch. Then press the Up/Down controls to check the data.

o The entering of program scan will be done in order of 1 - 9, 0.

The entering is done over than 10, the data will be rewritten by newly entered data.

o Pressing numeric keys(1-9,0), Function Key, and Program Key will cancel the entering of Program Scan. (Be sure to press in the above order of pressing)

How to make Program Scanning

- The function scanning 10 pre-programmed channels.

1 Adjust the squelch control to cut out the back-ground noise.

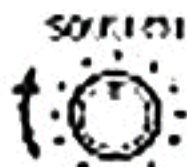

2 Press the Program Scan, "PCM SCAN" control. Display shows the "PCM-SCAN" and the receiver start program scanning.



3 The program scan will be done in order of "PM 1 - 9, 0" indicated on the display only for the channels already entered in program scanning.

4 Pressing again "Program" key cancels "Program Scan" and returns the condition just before entering into program scanning.

5 While program scanning, the controls of Tuning Dial is not available. And, while receiving, halting of program scanning, turn the tuning dial change the 1 channel of program channel and continue the program scan mode.

Pause and Selection of Direction

■ Pause

While program scanning, pressing Up/Down keys stops scanning and the receiver will wait for signals at the frequency displayed for a second.

■ Selection of Direction

While stopping scanning, pressing Up/Down keys will change 1 channel and select the direction in a subsequent scanning.

(EXAMPLE) Scan the channel preprogrammed in "Program Scan"

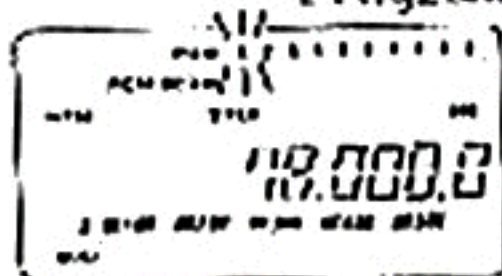

PCM SCAN

Starts program scanning. Then, the program number receiving signals will flicker on the display.

ABOUT THE PRIORITY FUNCTION :

Entering of Priority Channel

■ This modes provides for a priority channel to be checked once every 6 seconds while receiving in the memory scanning, program scanning, Search, Memory calling receiving and manual receiving. (When receiving the Priority channel, the display shows "Pch" at the part for indicating memory channel number.)

1 In the Manual mode, enter the frequency to be received at the Priority channel.

2 Select the wave mode.

3 Press the Numeric Key "0".



4 Press the "Function" key.



5 Press the Memory Write key "MEM.WRITE" and operation will complete with beep sounds, pip, pip.



- 3 The entering of Priority channel can be done by entering into "0ch".
- 4 The initial set of priority channel is at 144.0MHz Narrow FM (NEM).
- 5 Checking the entering into priority channel can be done by calling "0ch".
- 6 The entering of priority channel can be done at the displayed frequency step and wave mode.

(EXAMPLE) Enter the 467.35MHz (NEM Mode) into Priority Channel.

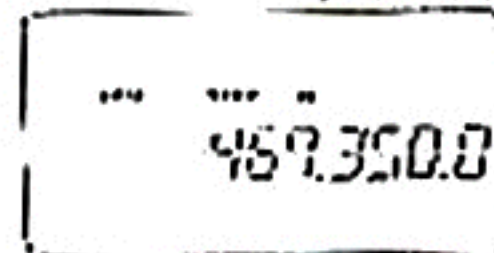

4 6 7 . 3 5

[ENTER] → FUNCTION

[NEM]

Enter the frequency and select the wave mode.

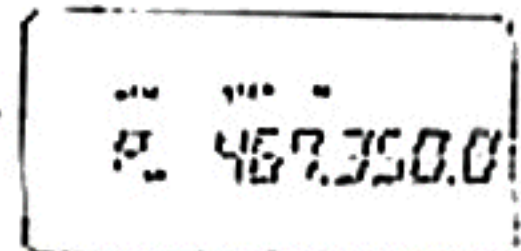

[0] → FUNCTION

[MEM.WRITE]

The entering is finished.

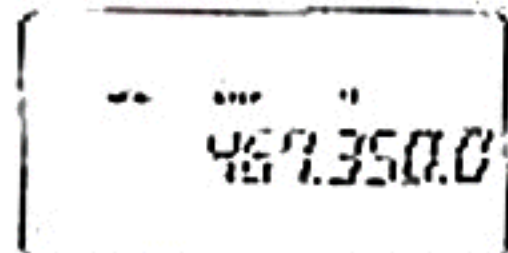

after 1 second, Pch display will disappear and the display shows only frequency.

Receiving of Priority Channel

1 While receiving, press the "Function" key. 

2 Pressing "Priority" activates priority function. In this time, display shows "PRI". 

3 The priority function can be cancelled by repressing the controls of (1) "Function" and (2) "Priority"

CHAPTER 4 USEFUL FUNCTIONS

Changing Band Memory Data(Search Band Memory Data).....	56
Skip Function	58
Delay Function	58
Non-Modulation Pass Function	59
"MCATN" Function	59
Battery Save Function	60
Eliminating of Beep Sound	60

CHANGING BAND MEMORY DATA

Programming Band Memory

At any time you may change each band memory to suit your own requirements.

(The unit is provided with pre-programmed band memory shown on page 63 of Japanese Instruction)

1 In the Manual mode, select the frequency step and wave mode.

2 Press the "Function" key 

3 Press the "BAND WRITE" key 

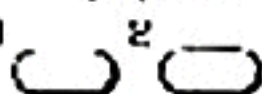
4 Enter the lowest limit frequency 

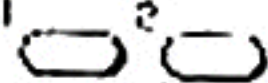
5 Enter the highest limit frequency. 

6 Press the key for selecting search band to be rewritten. 

7 Press the "Enter" key. The rewriting will be completed with beep sounds pip pip. 

8 If the highest limit frequency is entered earlier than the lowest limit frequency, the changing band memory data can be done without any problems.

(EXAMPLE) Rewrite the data memorized in the Band Selection Key (MARINE) to Narrow FM mode, at 10KHz step and frequency range from 1260MHz to 1300MHz.

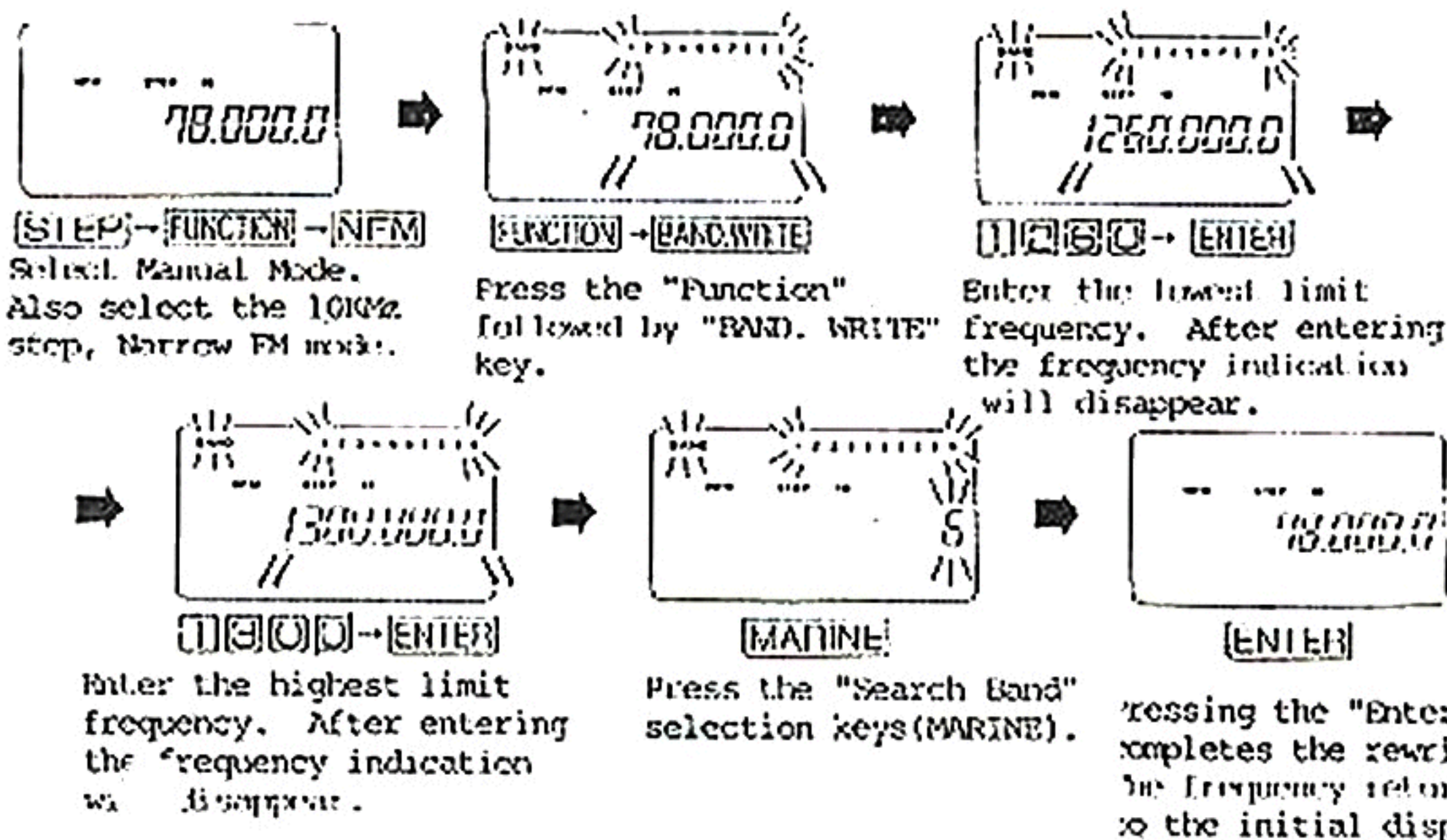

SKIP Function

- By pressing the "SKIP" key, the scan (Memory, Program) and Search modes will halt for 5 seconds at every station found before resuming the scan/search.

1 Press the "Function" key 

2 Pressing the "SKIP" key to activate the function. 

The Skip function will not activate on the way of entering (Flickering Condition).

3 Pressing again the "Function" and "SKIP" keys cancels the operation.

While activating the "SKIP" function the display shows "SKIP".

"NON-MODULATION PASS" (AF SCAN)

- When in Memory Scan, Program Scan and Search modes, the receiver will normally stop at every transmission found including blank carriers. Press "Function" + "AF.SCAN" and the receiver will pause for 3 seconds only if a blank carrier is found and then resume scan/search.

1 Press the "Function" key 

2 Pressing the "AF SCAN" key activates the "Non-Modulation Pass" function. 

3 Pressing again "Function" + "AF SCAN" cancels the operation.

While activating this function, the display of "SCAN" "PGM-SCAN" "SEARCH" will flicker.

(Caution) The function will not activate on the way of entering by numeric keys. (Flickering condition.)

DELAY Function

- During Scan/Search the receiver will only pause for duration of the signal. Once signal ceases the scan/search will resume. Press the "Function" + "Delay" to provide a 4 second pause after station ceases transmission. (Normally the above time is set at a 2 second pause.)

1 Press the "Function" key 

2 Pressing the "Delay" activates the delay function. 

3 Pressing again the "Function" and "DELAY" keys cancels the operation.

While activating the "DELAY" function the display shows "DELAY".

(Caution) The delay function can not activate on the way of entering by numeric key. (Flickering condition.)

"AGAIN" Function

- During "Search" mode, Pressing the "AGAIN" key returns the frequency to the previous frequency, just before changing frequency. And during Memory Scan mode, return to the channel just before pressing this controls.

1 Press the "Function" key 

2 Pressing the "AGAIN" key activates "AGAIN" function. 

3 The "AGAIN" function will work for only "Search" and "Scan" mode of memory channels.

BATTERY SAVE Function

■ This useful feature reduces the amount of battery drain dramatically. It can only be used when single frequency monitoring is being employed. (only for Manual receiving and Memory Call signals. Not available for scan/search mode.)

1 Press the "Function" key 

2 Pressing the "SAVE" key  activates the battery save function.

☞ While activating battery save function and the receiver is at power "OFF" condition with no signal, the display shows "SLEEP".

ELIMINATING BEEP SOUND

1 Press the "Function" key 

2 Pressing the "BEEP" key  eliminates the beep sound.

☞ Pressing again the "Function" + "Beep" resume beep sound.

☞ The display shows "BEEP" while receiver is set to have beep sound.

☞ The unit ensures the operations with Beep sound.

The beep sounds are as follows:

Numeric Key and Single Key ... Pip.
Completing of Entering ... pip, pip.
(Entering of Memory, Memory Erasing)

Error pip, po, po.

(Caution) The eliminating of Beep sound cannot be set on the way of entering by numeric keys. (Flickering condition.)

General Information:

Specifications:

Receiving Frequency

Receiving Frequency Range(Guaranteed)
8 - 1300 MHz

(Display Frequency Range: 0.1-1300MHz)

Frequency Step

5/10/12.5/25/50/100kHz

(WFM Mode: 50/100kHz Selectable)

Receiving Wave Mode

WFM/NFM/AM

Receiving Sensitivity

NFM: 0.5uV max.(SINAD 12dB)

(Max. 1uV for 1000-1300MHz)

WFM: 0.7mV Standard(SINAD 12dB)

AM : 0.5uV Standard(S/N 10dB)

Number of Memory

Memory Channel: 200

Band Memory : 10

Priority Channel Memory: 1

Scan/Search Speed

Approx. 15ch/20 steps

Antenna Impedance

50 ohms

Power Source

Ni-Cad Battery 4 pcs.(4.8V)

External Power 12V(Common use for Charging)

Speaker Max. Output

130mW minimum (4.8V 8 ohms)

Current Consumption

at Max. Output Power: 160mA(Standard)

at Stand-by : 95mA (Standard)

Operating Temperature(Guaranteed)

0°C - 50°C

Size & Weight:

64.4(W)x159.0(H)x40.0mm 130g

Accessories:

- Rod Antenna (1)
- Car Connector (1)
- AC Adapter(100V AC)(1)
- Ni-Cad. Battery (4)*Built-in
- Hand-Strap (1)
- Belt-Clip (1)
- Belt-Clip Screws (2)
- Ear-Plugs (1)
- User's manual (1)
- Guarantee Card (1)

Optional Accessory: Soft Case (SP-50)

NAME	Range Frequency (MHz)		Step (kHz)	MODE
	Lowest Limit	Highest Limit		
1 FM	76	90	50	WFM
2 AIR V	108.0	142.0	50	AM
3 AIR U	250.0	327.5	100	AM
4 HAM V	144.0	146.0	10	NFM
5 FIRE	146.01	154.5	10	NFM
6 MARINE	156.0	162.05	12.5	NFM
7 POLICE U	347.1875	353.05	12.5	NFM
8 HAM U	430.0	440.0	10	NFM
9 MCA	650.025	659.975	12.5	NFM
10 PPSNL	903.0375	904.9875	12.5	NFM

(ABOVE DATA IS ENTERED INITIALLY AT FACTORY)