



HF/VHF/UHF  
ALL MODE Transceiver  
**FT-897/-897D**  
Technical Supplement

©2010 VERTEX STANDARD CO., LTD. EH012M90D

**VERTEX STANDARD CO., LTD.**  
4-8-8 Nakameguro, Meguro-Ku, Tokyo 153-8644, Japan

**VERTEX STANDARD**  
**US Headquarters**  
10900 Walker Street, Cypress, CA 90630, U.S.A.

**YAESU UK LTD.**  
Unit 12, Sun Valley Business Park, Winnall Close  
Winchester, Hampshire, SO23 0LB, U.K.

**VERTEX STANDARD HK LTD.**  
Unit 5, 20/F., Seaview Centre, 139-141 Hoi Bun Road,  
Kwun Tong, Kowloon, Hong Kong

**VERTEX STANDARD (AUSTRALIA) PTY., LTD.**  
Normanby Business Park, Unit 14/45 Normanby Road  
Notting Hill 3168, Victoria, Australia



## Introduction

This manual provides technical information necessary for servicing the FT-897/D HF/VHF/UHF ALL MODE Transceiver.

Servicing this equipment requires expertise in handling surface-mount chip components. Attempts by non-qualified persons to service this equipment may result in permanent damage not covered by the warranty, and may be illegal in some countries.

Two PCB layout diagrams are provided for each double-sided circuit board in the Transceiver. Each side of is referred to by the type of the majority of components installed on that side (“leaded” or “chip-only”). In most cases one side has only chip components, and the other has either a mixture of both chip and leaded components (trimmers, coils, electrolytic capacitors, ICs, etc.), or leaded components only.

While we believe the technical information in this manual to be correct, VERTEX STANDARD assumes no liability for damage that may occur as a result of typographical or other errors that may be present. Your cooperation in pointing out any inconsistencies in the technical information would be appreciated.

## Contents

<b>Specifications .....</b>	<b>2</b>
<b>Exploded View &amp; Miscellaneous Parts .....</b>	<b>4</b>
<b>Block Diagram .....</b>	<b>5</b>
<b>Circuit Description .....</b>	<b>7</b>
<b>Alignment .....</b>	<b>10</b>

<b>Board Unit (Schematics, Layouts &amp; Parts)</b>	
MAIN Unit .....	23
PLL Unit .....	69
PA Unit .....	89
PANEL Unit .....	117
MIC Unit .....	137
VR Unit .....	140
BATT-CONN Unit .....	141
REF Unit .....	142
TCXO-9 Unit .....	143

# Specifications

## General

<b>Frequency Range:</b>	Receive: 0.1-56 MHz, 76-108 MHz, 118-164 MHz, 420-470 MHz Transmit: 160 - 6 Meters, 2 Meters, 70 Centimeters (Amateur bands only) 5.1675 MHz (Alaska Emergency Frequency: USA only)
<b>Emission Modes:</b>	A1 (CW), A3 (AM), A3J (LSB/USB), F3 (FM), F1 (9600 bps packet), F2 (1200 bps packet)
<b>Synthesizer Steps (Min.):</b>	10 Hz (CW/SSB), 100 Hz (AM/FM/WFM)
<b>Antenna Impedance:</b>	50 Ohms, Unbalanced (M)
<b>Operating Temp. Range:</b>	+14 °F to +140 °F (-10 °C to +60 °C)
<b>Frequency Stability:</b>	±4 ppm from 1 min. to 60 min after power on. @25 °C: 1 ppm/hour ±0.5 ppm/1 hour @25 °C, after warmup (FT-897: with optional TCXO-9)
<b>Supply Voltage:</b>	Normal: 13.8 VDC ±15 %, Negative Ground FNB-78 (Ni-MH Battery Pack): 13.2 V (Option)
<b>Current Consumption:</b>	Squelched: 600 mA (Approx.) Receive: 1 A Transmit: 22 A
<b>Case Size (W x H x D):</b>	7.87" x 3.15" x 10.3" (200 x 80 x 262 mm)
<b>Weight (Approx.):</b>	8.6 lb (3.9 kg) (w/o Ni-MH battery, antenna, Microphone)

## Transmitter

<b>RF Power Output (@13.8 V DC):</b>	SSB/CW/FM	AM Carrier
160- 6 Meter:	100 W	25 W
2 Meter:	50 W	12.5 W
70 Centimeter:	20 W	5 W
<b>Modulation Types:</b>	SSB: Balanced Modulator, AM: Early Stage (Low Level), FM: Variable Reactance	
<b>FM Maximum Deviation:</b>	±5 kHz (FM-N: ±2.5 kHz)	
<b>Spurious Radiation:</b>	-50 dB (1.8-29.7 MHz) -60 dB (50/144/430 MHz)	
<b>Carrier Suppression:</b>	>40 dB	
<b>Opp. Sideband Suppression:</b>	>50 dB	
<b>SSB Frequency Response:</b>	400 Hz-2600 Hz (-6 dB)	
<b>Microphone Impedance:</b>	200-10k Ohms (Nominal: 600 Ohms)	

# Specifications

## Receiver

<b>Circuit Type:</b>	Double-Conversion Superheterodyne (SSB/CW/AM/FM) Superheterodyne (WFM)			
<b>Intermediate Frequencies:</b>	1st: 68.33 MHz (SSB/CW/AM/FM); 10.7 MHz (WFM) 2nd: 455 kHz			
<b>Sensitivity:</b>		SSB/CW	AM	FM
	100 kHz-1.8 MHz	–	32 $\mu$ V	–
	1.8 MHz-28 MHz	0.2 $\mu$ V	2 $\mu$ V	–
	28 MHz-30 MHz	0.2 $\mu$ V	2 $\mu$ V	0.5 $\mu$ V
	50 MHz-54 MHz	0.125 $\mu$ V	1 $\mu$ V	0.2 $\mu$ V
	144/430 MHz	0.125 $\mu$ V	–	0.2 $\mu$ V
	(SSB/CW/AM = 10 dB S/N, FM = 12 dB SINAD)			
<b>Squelch Sensitivity:</b>		SSB/CW/AM	FM	
	100 kHz-1.8 MHz	–	–	
	1.8 MHz-28 MHz	2.5 $\mu$ V	–	
	28 MHz-30 MHz	2.5 $\mu$ V	0.32 $\mu$ V	
	50 MHz-54 MHz	1 $\mu$ V	0.16 $\mu$ V	
	144/430 MHz	0.5 $\mu$ V	0.16 $\mu$ V	
<b>Image Rejection:</b>	HF/50 MHz: 70 dB, 144/430 MHz: 60 dB			
<b>IF Rejection:</b>	60 dB			
<b>Selectivity (–6/–60 dB):</b>	SSB/CW: 2.2 kHz/4.5 kHz AM: 6 kHz/20 kHz FM: 15 kHz/30 kHz FM-N: 9 kHz/25 kHz SSB (optional YF-122S installed): 2.3 kHz/4.7 kHz (–66 dB) CW (option YF-122C installed): 500 Hz/2.0 kHz			
<b>AF Output:</b>	2.5 W (@4 Ohms, 10% THD or less)			
<b>AF Output Impedance:</b>	4-16 Ohms			

Specifications are subject to change without notice, and are guaranteed within the amateur bands

# Exploded View & Miscellaneous Parts

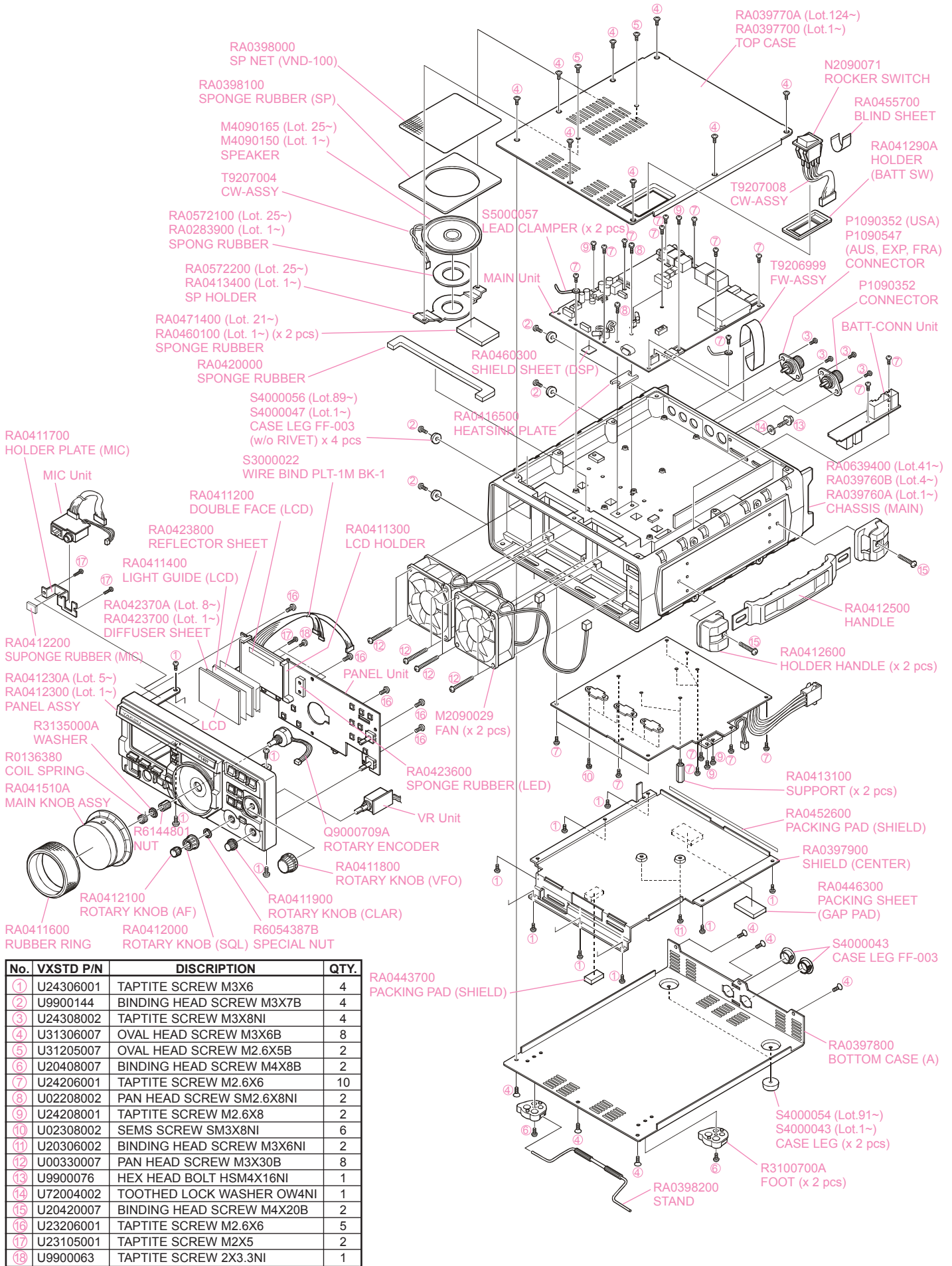

No.	VXSTD P/N	DISCRIPTION	QTY.
①	U24306001	TAPTITE SCREW M3X6	4
②	U9900144	BINDING HEAD SCREW M3X7B	4
③	U24308002	TAPTITE SCREW M3X8NI	4
④	U31306007	OVAL HEAD SCREW M3X6B	8
⑤	U31205007	OVAL HEAD SCREW M2.6X5B	2
⑥	U20408007	BINDING HEAD SCREW M4X8B	2
⑦	U24206001	TAPTITE SCREW M2.6X6	10
⑧	U02208002	PAN HEAD SCREW SM2.6X8NI	2
⑨	U24208001	TAPTITE SCREW M2.6X8	2
⑩	U02308002	SEMS SCREW SM3X8NI	6
⑪	U20306002	BINDING HEAD SCREW M3X6NI	2
⑫	U00330007	PAN HEAD SCREW M3X30B	8
⑬	U9900076	HEX HEAD BOLT HSM4X16NI	1
⑭	U72004002	TOOTHED LOCK WASHER OW4NI	1
⑮	U20420007	BINDING HEAD SCREW M4X20B	2
⑯	U23206001	TAPTITE SCREW M2.6X6	5
⑰	U23105001	TAPTITE SCREW M2X5	2
⑱	U9900063	TAPTITE SCREW 2X3.3NI	1

# Block Diagram

## BLOCK-DIAGRAM

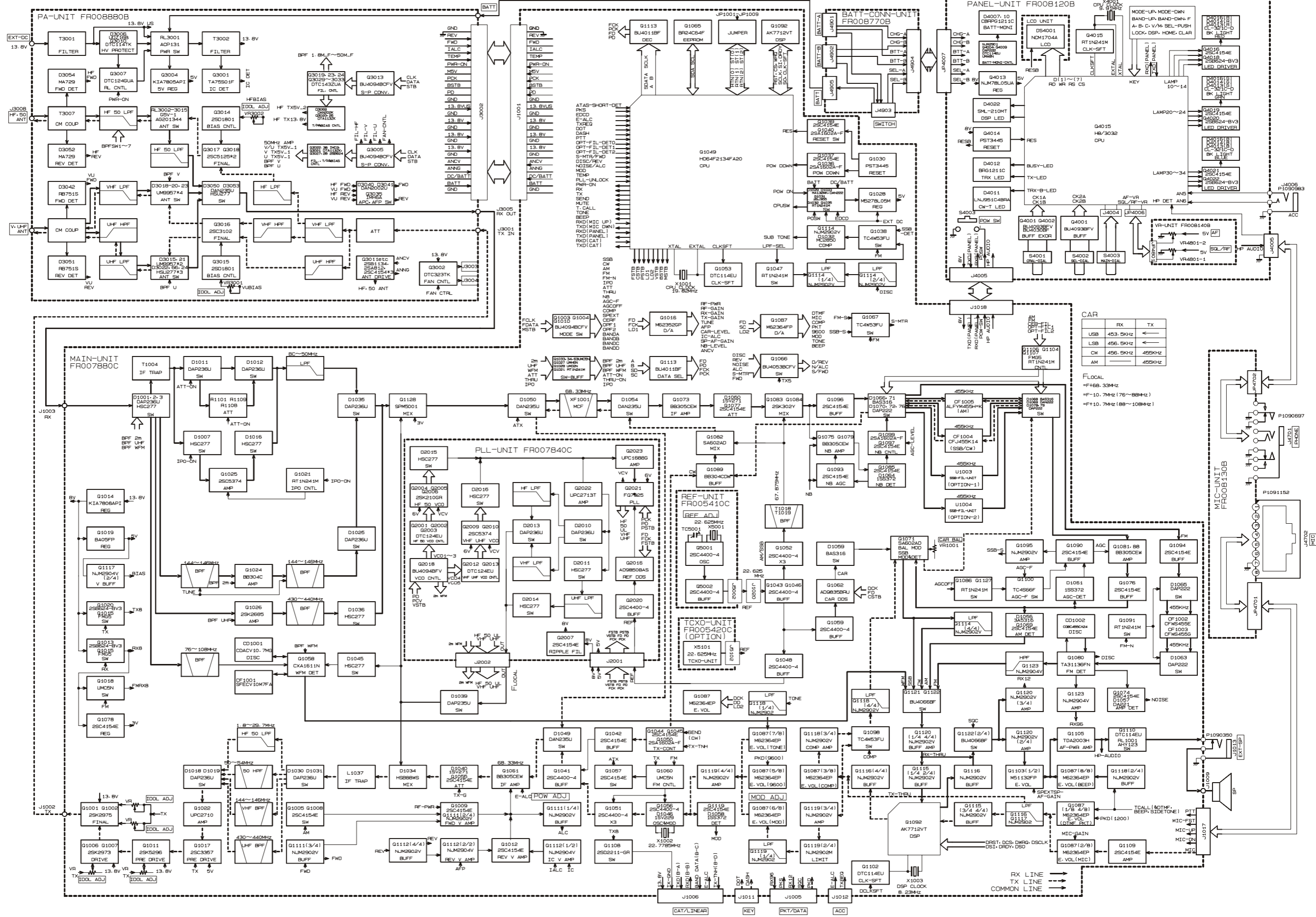

# Interconnection Diagram

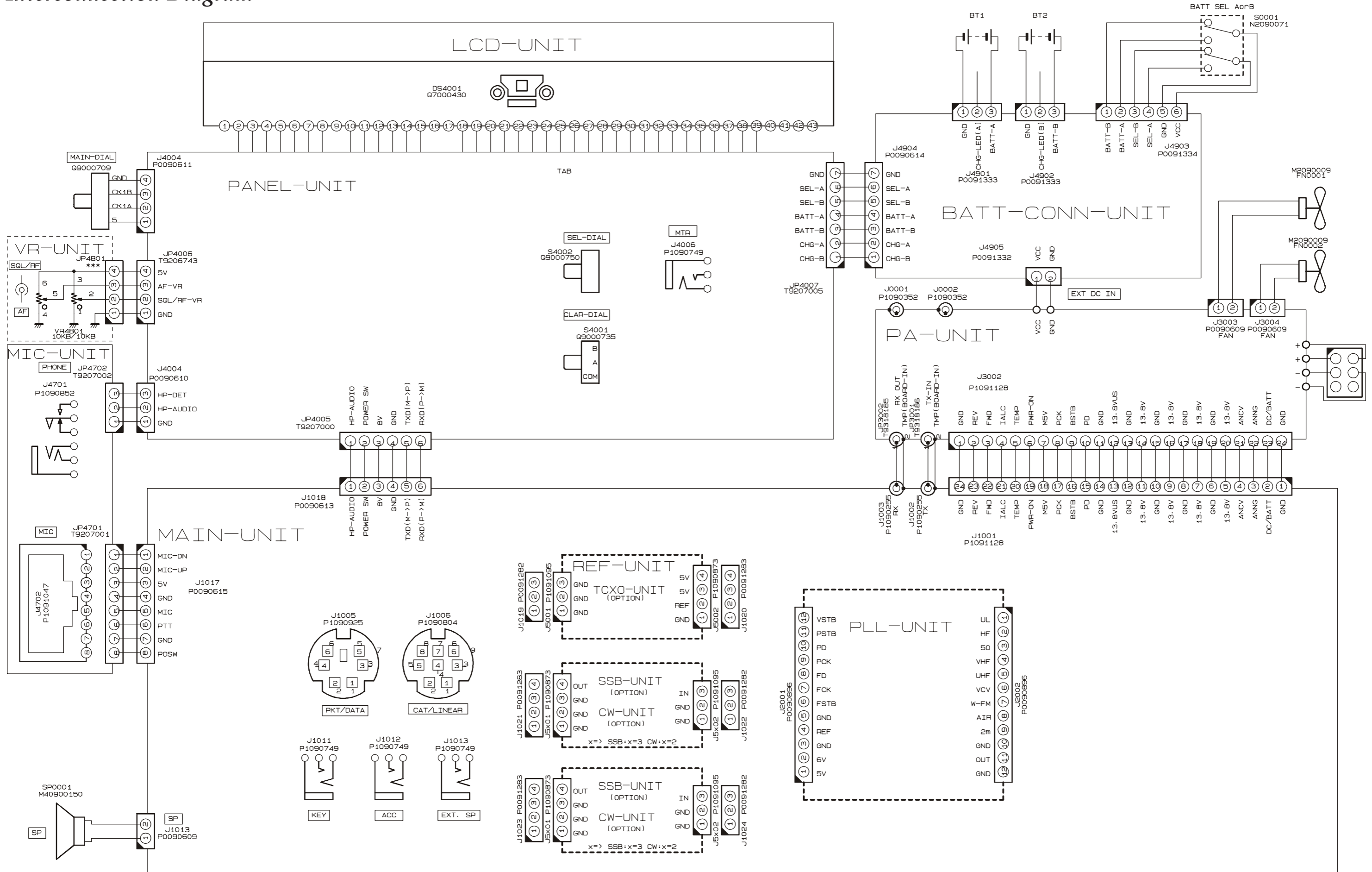

# Circuit Description

The **FT-897** internal assembly consists of the MAIN Unit, PLL Unit, PA Unit, Panel Unit, BATT-CONN Unit, REF Unit, MIC Unit, and the VR Unit.

## Receive Signal Circuitry

### RF Stages

Signals between 0.1 and 56 MHz received at the antenna terminal pass through a low-pass filter, selected according to the receiving frequency, then pass to another low-pass filter, to remove unwanted out-of-band signals. The filtered receiving signal passes, through one of the following circuits, to the 1st Mixer Q1128 (**SPM5001**): (1) an attenuator network (-10dB) which consists of resistors R1101, R1108, R1109; (2) a “through” circuit enabled via diodes D1011 and D1012 (both **DAP236U**); or (3) RF amplifier Q1025 (**2SC5374**).

Received 430 MHz signals, after passing through a high-pass filter composed of L3052, L3059, C3209, C3210, C3219, C3223, and C3319, are passed through low-pass filter composed of L3042, L3045, C3165, C3168, C3177, C3180, C3192, and C3196, and through a directional coupler, to the UHF T/R switch circuit composed of diode switch D3015/D3021 (both **UM9957F**), D3022, and D3066 (both **HSU277**). Then the signals are fed to the 1st Mixer Q1128 via the RF-AMP, Q1026 (**2SK2685**).

Received 145 MHz signals, after passing through a high-pass filter composed of L3060, L3050, L3047, C3200, C3203, C3220, and C3221, are passed through a low-pass filter composed of L3043, L3044, C3167, C3169, C3176, C3179, and C3191, and a directional coupler, to the VHF T/R switch circuit, composed of diode switch D3018/D3020 (both **UM9957F**). Then the signals are fed to 1st Mixer Q1128 via the RF-AMP, Q1024 (**BB304CDW**).

Received 76-108 MHz signals, after passing through a high-pass filter composed of L3060, L3050, L3047, C3200, C3203, C3220, and C3221, are passed through low-pass filter composed of L3043, L3044, C3167, C3169, C3176, C3179, and C3191, and a directional coupler, to the T/R switch circuit, composed of diode switch D3018/D3020 (both **UM9957F**). Then it is fed to the Wide-FM IF IC Q1058 (**CXA1611N**) on the MAIN Unit.

### 1st Mixer Circuit/1st IF Circuit

The 1st mixer on the MAIN Unit consists of quad MOS FET Q1128 (**SPN5001**), where the receiving signal is mixed with the 1st local signal (68.430-538.330 MHz) from the PLL Unit. The resulting output signal (68.33 MHz) passes through monolithic crystal filter (MCF) XF1001 (**MF68Q**, BW: ±6.0 kHz) to obtain the 1st IF signal with a center frequency of 68.33 MHz. The IF signal passes through the 1st IF amplifier Q1073 (**BB305CEW**) to the 2nd Mixer, Q1083 and Q1084 (both **2SK302Y**).

### 2nd Mixer Circuit/2nd IF Circuit

The 2nd Mixer consists of FETs Q1083 and Q1084 (both **2SK302Y**) on the MAIN Unit, where the 1st IF signal is mixed with the 2nd local signal (67.875 MHz). The resulting output signal (455 kHz) is applied to the 2nd IF filter which is matched to the receiving mode: either CF1004, CF1005 or an optional mechanical filter.

### Noise Blanker Circuit

A portion of the 2nd IF signal is amplified by Noise Blanker Amplifiers Q1075 and Q1079 (both **BB305CEW**) on the MAIN Unit, and then rectified by D1064 (**1SS372**). This output is applied to the Noise Blanker Controllers, Q1093 (**2SC4154E**) and Q1099 (**2SA1602A**), which yield Blanking signal according to the timing of the incoming noise pulses. Then Blanking signal controls the Noise Blanker Gate D1066 (**BAS316**), to slice out the impulse noise from the signal.

### AGC Circuit

The AGC circuit consists of D1061 (**1SS372**), transistor Q1090 (**2SC4154E**), and associated parts on the MAIN Unit. Output from the AGC circuit is fed back to the IF AGC circuit that controls the gain of the IF amplifier FETs.

### FM IF Circuit/FM Demodulator Circuit

On FM, the 2nd IF signal passes through the buffer amplifier Q1094 (**2SC4154E**) and 2nd IF filters (**CF1002** and **CF1003**) to the FM IF IC Q1080 (**TA31135FN**) which contains a mixer, limiter amplifier, filter amplifier, squelch trigger, and demodulator. The demodulated audio signal at Q1080 passes through a low-pass filter (R1339 and C1282) and a de-emphasis circuit (R1303 and C1345), then proceeds to the Audio Amplifier Circuit.

The squelch circuit selectively amplifies the noise component of the demodulator output using the filter amplifier inside the FM IF IC and an active band-pass filter consisting of an externally attached resistor and capacitor. Signal detection is performed by D1057 (**DA221**).

# Circuit Description

## *SSB/CW Demodulator Circuit*

The 2nd IF SSB/CW signal passes through buffer amplifiers Q1088 and Q1081 (both **BB305CEW**) to the SSB balanced demodulator Q1071 (**SA602AD**) which produces audio by applying the carrier signal from the CAR-DDS IC Q1062 (**AD9835BRU**). The demodulated audio signal is stripped of high-frequency components by an active low-pass filter, op-amp IC Q1120 (**NJM2902V**), then is applied to the Audio Amplifier Circuit.

## *AM Demodulator Circuit*

The 2nd IF AM signal passes through buffer amplifiers Q1088 and Q1081 (both **BB305CEW**) to the AM demodulator D1055 (**BAS316**), yielding demodulated audio signal which is applied to the Audio Amplifier Circuit.

## *Audio Amplifier Circuit*

The demodulated audio signal is passed through AF pre-amplifier Q1119 (**NJM2902V**) and electronic volume control IC Q1087 (**M62364EP**) to the AF Amplifier IC Q1105 (**TDA2003H**) which drives the internal or external speaker to a maximum output of approximately 2.5 Watts.

## *Transmit Signal Circuitry*

### *Microphone Amplifier Circuit*

The audio signal from microphone jack on the MIC Unit is amplified by audio amplifier Q1109 (**2SC4154E**) on the MAIN Unit, and then is applied to electronic volume control IC Q1087 (**M62364EP**), the level of which is set via the User Menu.

### *SSB Modulator Circuit*

The output (audio signal) from the electronic volume control IC is passed through audio amplifier Q1118 (**NJM2902V**) to the balanced modulator IC Q1071 (**SA602AD**) which produces a Double Sideband (DSB) signal by applying the carrier signal from the CAR-DDS IC Q1062 (**AD9835BRU**). The DSB modulated signal (455 kHz) is fed to ceramic filter CF1004 (or the optional mechanical filter) which strips residual carrier and the undesired sideband, resulting in a Single Sideband (SSB) signal.

### *AM Modulator Circuit*

As in the SSB modulator circuit, a carrier signal appropriate to the transmitting mode (AM) from the CAR-DDS Unit and an audio signal from the microphone are applied to balanced modulator IC Q1071 (**SA602AD**). The control signal from Mode Switch IC Q1003 (**BU4094BCFV**) causes a voltage (“AM 5V”) to be sent from transistor Q1058 (**2SC4154E**). This voltage is applied to IC Q1071 via D1059 (**BAS316**), causing the balanced modulator to lose balance. The restored carrier signal and modulated signal are then fed to the TX mixer via ceramic filter CF1004.

### *FM Modulator Circuit*

The output (audio signal) from the electronic volume control IC is passed through the pre-emphasis circuit which consists capacitor C1492 and resistors R1493 and R1477, and Instantaneous Deviation Control Q1119 (**NJM2902V**), to the splatter filter which consists Q1119, capacitor C1430, and resistors R1358 and R1384. The filtered audio signal is applied to the FM modulator circuit, which produces the FM signal. The FM modulator circuit uses a voltage controlled crystal oscillator (VCXO) which consists Q1055 (**2SC4400**), D1046 (**1SV229**), and X1002 (22.7767 MHz).

### *1st IF Circuit/1st Mixer Circuit*

The modulated SSB/AM signal is applied to the 2nd Mixer Q1082 (**SA602AD**), which produces the 68.33 MHz 2nd IF signal utilizing the 2nd local signal (68.875 MHz). The 2nd IF signal is fed through the 2nd IF filter XF1004 which strips away unwanted mixer products, then passes through the 2nd IF amplifier Q1061 (**BB304CDW**) to the double balanced mixer D1034 (**HSB88WS**) which produces the transmit frequency by applying the local signal (68.430-538.330 MHz) from the PLL Unit. The transmit signal is passed through a low-pass filter (1.8-29.7 MHz), a high-pass filter (50-54 MHz), a band-pass filter (144-146 MHz), or a band-pass filter (430-450 MHz) which consists of various inductors and capacitors. The filtered transmit signal is amplified by Q1017 (**2SC3357**), Q1011 (**2SK2596**), Q1006/Q1007 (**2SK2973**), and Q1001/1002 (**2SK2975**), and is applied to the Power Amplifier: Q3017/Q3018 (**2SC5125**: HF/50 MHz) or Q3016 (**2SC3102**: 144/430 MHz).



# Circuit Description

## *ALC Circuit*

The output from the directional coupler is routed from connector J3002 and applied to the ALC circuit via connector J1001 on the MAIN Unit.

The ALC circuit consists of an op-amp circuit for amplifying the forward and reflected voltage, a time-constant ALC amplifier, and a transmit signal control circuit on the MAIN Unit. The forward voltage from connector J1001 on the MAIN Unit is added with a DC control voltage and is then applied to op-amp IC Q1111 (**NJM2902V**). The reflected voltage is added with a DC control voltage and is then applied to op-amp IC Q1112 (**NJM2904V**). In the event of high SWR conditions (SWR 3:1 or more), transmitter output is reduced, thus protecting the PA Unit from potential damage; a “HI SWR” indication also appears on the LCD, alerting the user to an antenna problem.

The ALC amplifier magnifies the forward wave output via transistor Q1009 (**2SC4154**). This output then passes through a fast-attack, slow-delay RC time-constant circuit, which consists of R1051 and C1051, for input to the TX signal control circuit on the MAIN Unit. The TX control circuit adjusts the IF amplifier gain via gate 2 of FET Q1061 (**BB304CDW**) of the 2nd IF amplifier circuit, to prevent the TX output from exceeding the preset level.

## *PLL Frequency Synthesizer*

The PLL Frequency Synthesizer consists mainly of the master reference oscillator circuit, 2nd local oscillator circuit, PLL IC, and CAR-DDS and REF-DDS units, which digitally synthesize carrier outputs, plus a PLL circuit which contains a voltage controlled oscillator (VCO).

## *Master Reference Oscillator Circuit*

The master reference oscillator uses a Crystal Oscillator (oscillation frequency: 22.625 MHz) composed of Q5001 (**2SC4400-4**), X5001, TC5001, C5001, and R5005. The reference oscillator signal passes through a buffer amplifier Q5002 (**2SC4400-4**), and is then fed to the MAIN Unit via J5002.

## *CAR-DDS Circuit REF-DDS Circuit*

DDS ICs Q1062 (**AD9835BRU**), and Q2016 (**AD9850BAS**) each contain a shift register, selector, phase accumulator, and ROM. The reference oscillation frequency (22.625 MHz) that is delivered to each of the DDS Units is applied to each DDS IC after amplification by transistors Q1043, Q1046, Q1048, and Q1059 (all **2SC4400-3**).

The DDS outputs contain digital amplitude data corre-

sponding to serial frequency data from CPU IC Q1049. The DDS frequency range is 453.5 ~ 466.5 kHz (center frequency = 455.0 kHz) for the CAR-DDS, and 7.2-8.0 MHz for the REF DDS.

## *1st Local Oscillator Circuit*

VCO output is buffer-amplified by Q2011 (**2SC5374**) and Q2022 (**UPC2713T**), and passes through a low-pass filter. It is then fed to the TX/RX frequency mixer circuitry of the MAIN Unit.

## *2nd Local Oscillator Circuit*

The 2nd LO circuit is a Hartley-type overtone oscillator circuit (frequency: 67.875 MHz) composed of Q1052 (**2SC4400-3**) on the MAIN Unit.

## *PLL Circuit*

The PLL circuit is a frequency mixing type composed of a VCO, mixer, PLL IC, and loop filter. The VCO consists of five circuits (VCO1, VCO2, VCO3, VCO4 and VCO5), with a frequency range of 68.430-538.330 MHz divided into five bands, allocated to the five VCO circuits. VCO1-VCO5 consist mainly of FETs Q2004, Q2005, and Q2006 (all **2SK210GR**); transistors Q2009 and Q2010 (both **2SC5374**); diodes D2001-D2006 (all **HVC362**), D2007 (**1SV282**), D2008 (**1SV281**), and D2009 (**1SV286**); and coils T2001-T2003, L2010, and L2011.

The VCO switching signal from the connector J2002 is used to drive switching transistors Q2001, Q2002, Q2003, Q2012, and Q2013 (all **DTC124EU**) to switch the source terminal of the oscillator FET.

The 68.430-538.330 MHz VCO signal is buffer-amplified by Q2023 (**UPC1688G**), and fed to PLL IC Q2021 (**FQ7925**.)

The REF-DDS signal (7.2-8.0 MHz) is fed to PLL IC Q2021 after it passes through a low-pass filter composed of C2064, C2067, C2069, C2071, C2075, L2014, L2015, and L2016, and is fed to PLL IC Q2021 (**FQ7925**.) The phase of the reference frequency and that of the signal input to the PLL IC are compared, and a signal whose pulse corresponds to the phase difference is produced.

# Alignment

## *Introduction and Precautions*

The following procedures cover adjustments that are not normally required once the transceiver has left the factory. However, if damage occurs and some parts subsequently be replaced, realignment may be required. If a sudden problem occurs during normal operation, it is likely due to component failure; realignment should not be done until after the faulty component has been replaced.

We recommend that servicing be performed by authorized Vertex Standard service technicians, experienced with the circuitry and fully equipped for repair and alignment. If a fault is suspected, contact the selling dealer for instructions regarding repair. Authorized Vertex Standard service technicians have the latest configuration information, and realign all circuits and make complete performance checks to ensure compliance with factory specifications after repairs.

Those who do undertake any of the following alignments are cautioned to proceed at their own risk. Problems caused by unauthorized attempts at realignment are not covered by the warranty policy. Also, Vertex Standard must reserve the right to change circuits and alignment procedures in the interest of improved performance, without notifying owners.

Under no circumstances should any alignment be attempted unless the normal function and operation of the transceiver are clearly understood, the cause of the malfunction has been clearly pinpointed and any faulty components replaced, and the need for realignment determined to be absolutely necessary.

The following test equipment (and thorough familiarity with its correct use) is necessary for complete realignment. Most steps do not require all of the equipment listed, but the interactions of some adjustments may require that more complex adjustments be performed in a sequence. Do not attempt to perform only a single step unless it is clearly isolated electrically from all other steps. Rather, have all test equipment ready before beginning, and follow all of the steps in a section in the order they are presented.

## *Required Test Equipment*

- Digital DC Voltmeter (high-Z, 1 M-Ohm/V)
- DC Ammeter
- RF Millivoltmeter
- AC Voltmeter
- RF Standard Signal Generator w/calibrated output and dB scale, 0 dB $\mu$  = 0.5 $\mu$ V
- Signal Generator with calibrated output
- Spectrum Analyzer good to at least 1 GHz.
- Frequency Counter
- 50-Ohm Dummy Load (200 watts)
- 100-Ohm Dummy Load (200 watts)
- 150-Ohm Dummy Load (200 watts)
- In-Line Wattmeter (200 watts, 50-Ohm)
- Linear Detector
- RF Coupler

## *Alignment Preparation & Precautions*

A 50-ohm RF Dummy load and in-line wattmeter must be connected to the main antenna jack in all procedures that call for transmission, except where specified otherwise. Correct alignment is not possible with an antenna.

After completing one step, read the following step to determine whether the same test equipment will be required. If not, remove the test equipment (except dummy load and wattmeter, if connected) before proceeding.

Correct alignment requires that the ambient temperature be the same as that of the transceiver and test equipment, and that this temperature be held constant between 68°~ 86°F (20° ~ 30°C). When the transceiver is brought into the shop from hot or cold air, it should be allowed time to come to room temperature before alignment.

Whenever possible, alignments should be made with oscillator shields and circuit boards firmly affixed in place. Also, the test equipment must be thoroughly warmed up before beginning.

**Note:** Signal levels in dB referred to in this procedure are based on 0 dB $\mu$  = 0.5  $\mu$ V (closed circuit).

## Local Oscillator Adjustment (FT-897 Only)

### Reference Frequency Adjustment

- Connect the frequency counter to **TP1032**.
- Adjust the trimmer capacitor (**TC5001**) for 67.875000 MHz ( $\pm 5$  Hz) on the frequency counter.
- Connect an RF millivoltmeter or an oscilloscope to pin 2 of **J5002 (TP1032)** and confirm that the output level is 115 mv ( $\pm 30$  mV) rms or 315 mv ( $\pm 80$ mV) p-p.

### 3rd Local Adjustment

- Connect an RF millivoltmeter or an oscilloscope to **TP1037**.
- Key the transceiver on CW, and adjust **T1025** for maximum indication on the RF millivolt-meter.
- Confirm that the indicated voltage is 100 mv ( $\pm 30$  mV) rms or 300 mv ( $\pm 100$ mV) p-p.

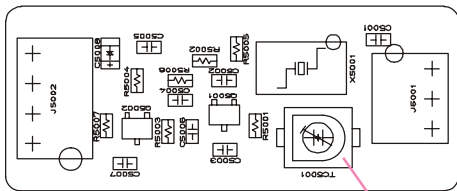

TC5001

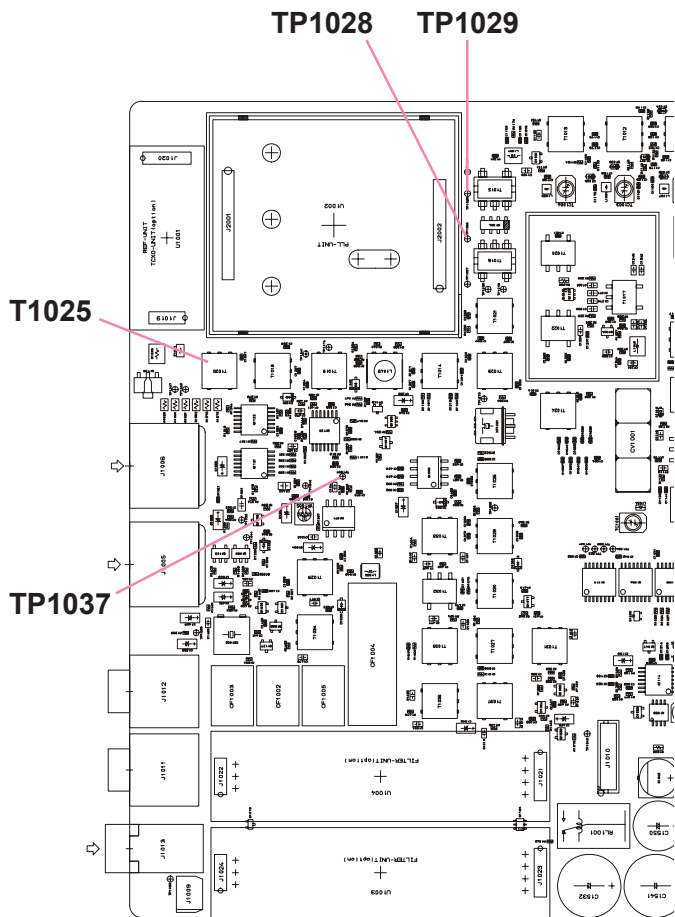

## PLL Adjustment

### VCO VCV Adjustment

- Connect the DC voltmeter to pin 6 of **J2002 (TP1028)** and, referring to the table below, tune the transformer/inductor on each frequency listed. Then confirm that the correct voltage is present, or adjust the listed component for the required voltage.

Tune to :	Adjust / Confirm	For
13.895 MHz	Adjust T2001	6.0V $\pm 0.1$ V
76.000 MHz	Confirm	At least 0.9V
32.995 MHz	Adjust T2002	6.0V $\pm 0.1$ V
13.900 MHz	Confirm	At least 0.9V
55.995 MHz	Adjust T2003	6.0V $\pm 0.1$ V
88.000 MHz	Confirm	At least 0.9V
163.995 MHz	Adjust L2010	5.5V $\pm 0.5$ V
118.000 MHz	Confirm	At least 0.8V
469.995 MHz	Adjust L2011	5.5V $\pm 0.5$ V
420.000 MHz	Confirm	At least 0.8V

### 1st Local Output Level

- Connect the RF millivoltmeter to pin 11 of **J2002 (TP1029)**, and set the transceiver to 28.000 MHz.
- Confirm that the RF level is at least +3 dBm or 300 mV rms.

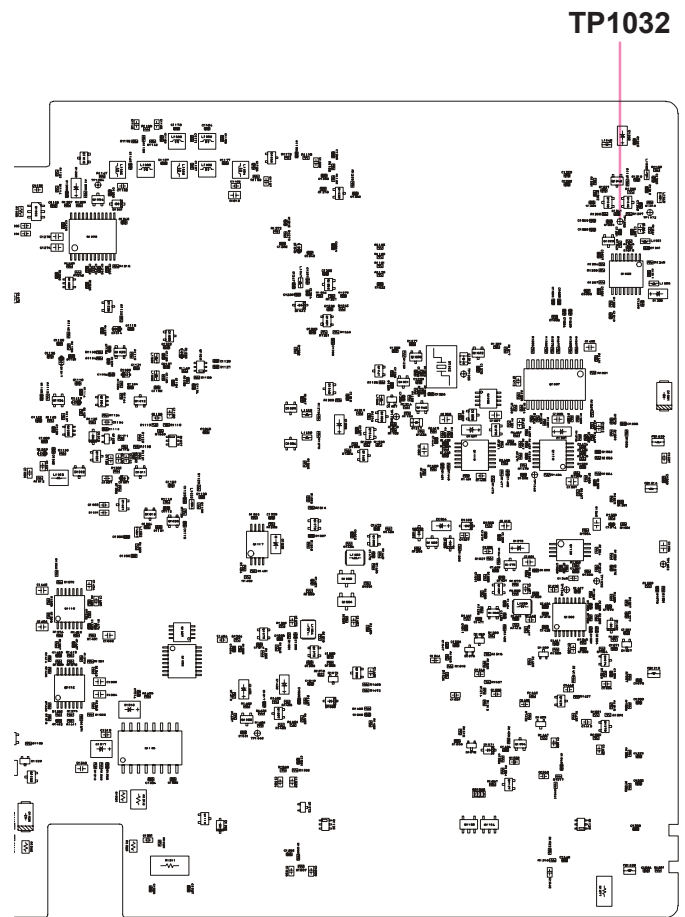

# Alignment

## PLL Unlock

- Connect the DC voltmeter to pin 1 of **J2002 (TP1027)**.
- Disconnect the reference oscillator input by unplugging the cable; confirm that the voltmeter shows less than 0.5 V and that “UNLOCK” is displayed on the LCD.
- Re-connect the reference input, and confirm that the voltmeter shows at least 3.5 V and that the LCD returns to its normal display.

## Idling Current Adjustment

Before alignment, set the mode to CW and tune the transceiver to 1.800 MHz. Nothing should be connected to the CW Key Jack. Switch off **S1001**.

### Pre-Driver Stage Idling Current

- Connect the ammeter between **TP1019** and **TP1020**.
- Press the PTT, and adjust **VR1004** for an indication of 30 mA ( $\pm 5$  mA) on the ammeter.

### Driver Stage Idling Current

- Connect the ammeter between **TP1017** and **TP1018**.
- Press the PTT and adjust **VR1003** for an indication of 60 mA ( $\pm 5$  mA) on the ammeter.

## Exciter Stage Idling Current

- Terminate **J1004** into an ammeter.
- Turn both **VR1001** and **VR1002** fully counterclockwise.
- Press the PTT and adjust **VR1002** for an indication of 50mA ( $\pm 10$  mA) on the ammeter.
- Press the PTT and adjust **VR1001** for an indication of 100mA ( $\pm 10$  mA) on the ammeter.
- Re-connect **J1004** and switch on **S1001**.

## TX IF Adjustment

### SSB/CW TX IF Adjustment

- Tune the frequency to the 14 MHz band. Connect the RF millivoltmeter to **TP1033**, and terminate **J1002** into a 50-Ohm dummy load.
- Inject a 1 kHz tone at 1 mV level to the **MIC jack**.

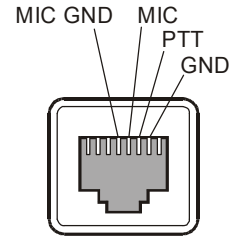

- Key the transmitter, and adjust **T1033**, **T1023**, **T1021** for maximum indication on the RF millivoltmeter.

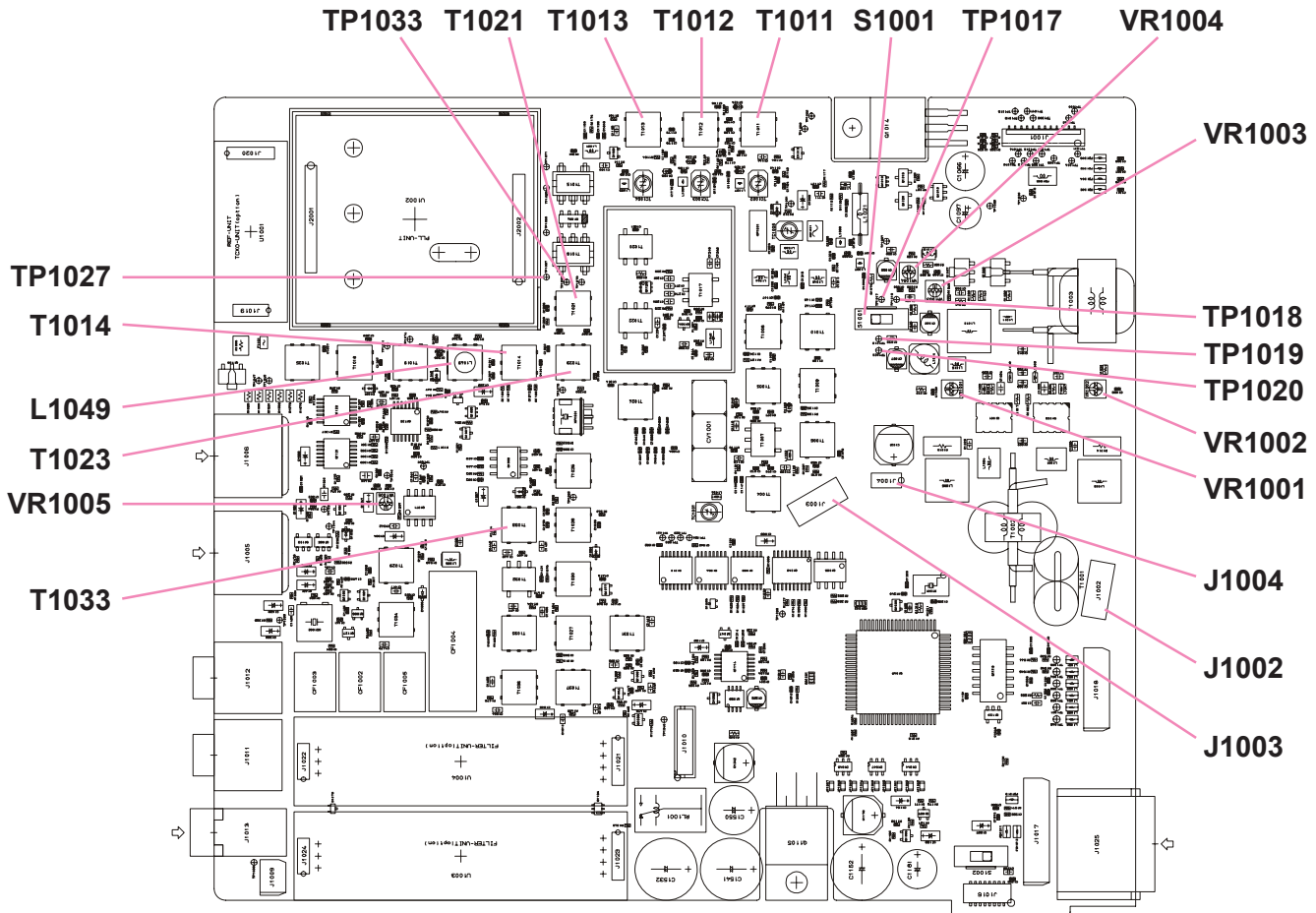

## FM TX IF Adjustment

- Tune the frequency to the 28 MHz band. Connect the RF millivoltmeter to **TP1033** and leave **J1002** terminated into a 50-Ohm dummy load.
- Key the transmitter in the FM mode, and adjust **T1014** alternately for maximum indication on the RF millivoltmeter.
- Connect the frequency counter to **TP1033**.
- Key the transmitter in the FM mode without microphone input. Adjust **L1049** for a reading of 68.3300 MHz ( $\pm 100$  Hz).

## Carrier Balance Adjustment

- Tune the frequency to the 14 MHz band. Terminate **J1002** into a 50-Ohm dummy load and connect a spectrum analyzer or a RF millivoltmeter at this point.
- Key the transmitter in the USB mode without microphone input. Adjust **VR1005** for maximum carrier suppression on the spectrum analyzer or for minimum indication on the RF millivoltmeter.

## VHF TX BPF Adjustment

- Set the frequency to 145.995 MHz. Connect the spectrum analyzer to **J1002**, which should be terminated into a 50-Ohm dummy load.
- Inject a 1 kHz tone at 1 mV level to the **MIC** jack.
- Key the transceiver in the USB mode, and adjust **T1013**, **T1012**, and **T1011** alternately for maximum indication on spectrum analyzer.

## UHF TX BPF Adjustment

- Set the frequency to 430.000 MHz. Connect the spectrum analyzer to **J1002**, which should be terminated into a 50-Ohm dummy load.
- Inject a 1 kHz tone at 1 mV level to the **MIC** jack.
- Key the transceiver in the USB mode, and adjust **TC1004**, **TC1003** and **TC1002** alternately for maximum indication on the spectrum analyzer.

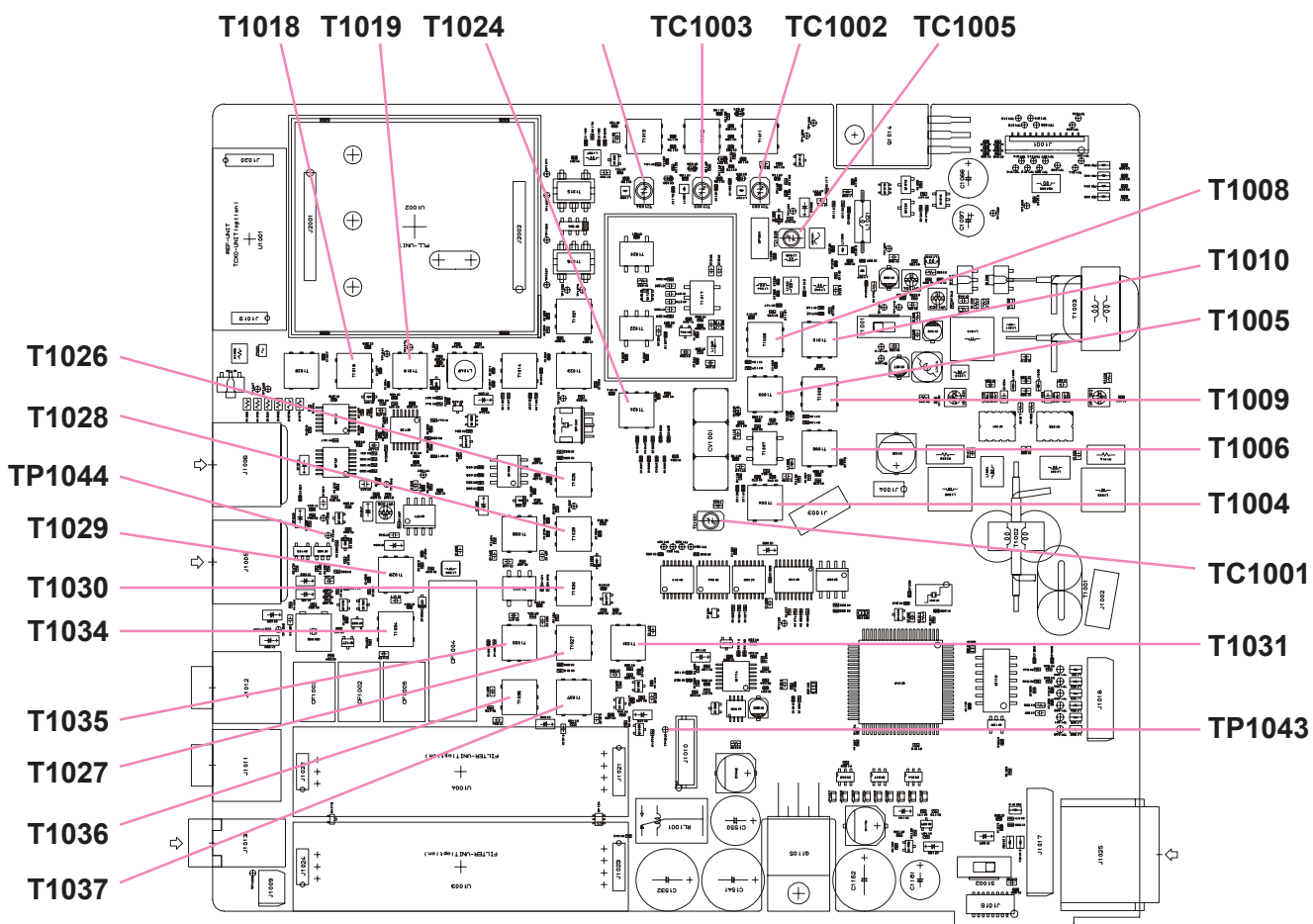

# Alignment

## *RX Adjustment*

The PA Unit must be connected during RX adjustments. The signal generator should not be connected to **J1003** directly because DC voltage is present there.

### *RX IF Adjustment*

Connect the signal generator to the antenna connector, and the SINAD meter to the speaker jack.

### *SSB IF Adjustment*

- Tune the transceiver to 51.995 MHz. Inject an RF signal from a signal generator at 0 dB $\mu$  output.
- Adjust **T1018**, **T1019**, **T1024**, **T1026**, **T1028**, **T1030**, **T1035**, **T1036**, **T1037**, **T1034** and **T1029** alternately for maximum indication on the DC voltmeter. Several passes may be necessary, as the adjustments inter-react to some degree.

### *FM IF Adjustment*

- Tune the transceiver to 51.995 MHz. Inject an RF signal from a signal generator at +5 dB $\mu$  output, with 1 kHz AF FM modulation at  $\pm$ 3.5 kHz deviation.
- Adjust **T1024**, **T1026**, and **T1028** alternately for maximum level on the S-meter.

### *Air-Band Reception Adjustment*

- Connect the DC voltmeter to **TP1044**.
- Tune the transceiver to 128.00 MHz in the AM mode. Inject an RF signal from the signal generator at 20 dB $\mu$  output, with 30% AM modulation at 400 Hz audio frequency.
- Adjust **T1005** and **T1008** for minimum indication on the DC voltmeter.

### *VHF Band Alignment*

- Connect the DC voltmeter to **TP1044**.
- Tune the transceiver to 145.995 MHz in the CW mode. Inject an RF signal from a signal generator at 20 dB $\mu$  output.
- Adjust **T1006**, **T1009** and **T1010** alternately for minimum indication on the DC voltmeter.

### *UHF Band Alignment*

- Connect the DC voltmeter to **TP1044**.
- Tune the transceiver to 439.995 MHz in the CW mode. Inject a RF signal from the signal generator at 20 dB $\mu$  output.
- Adjust **TC1001** for minimum indication on the DC voltmeter.

### *W-FM Reception Adjustment*

- Connect the SINAD meter to the speaker jack.
- Tune the transceiver to 88.00 MHz. Inject a RF signal from the signal generator at 30dB $\mu$  output, with  $\pm$ 22.5 kHz deviation FM modulation of a 1 kHz audio signal.
- Adjust **TC1005** for the best SINAD sensitivity. Then reduce the output level of the signal generator to where the signal just begins to sound slightly “noisy,” and adjust **TC1005** again for best SINAD.

### *Image Rejection Trap Adjustment*

- Connect the AF millivoltmeter to the speaker jack.
- Tune the transceiver to 51.995 MHz in the FM mode. Inject an RF signal from the signal generator at 68.330 MHz, with 70 dB $\mu$  output.
- Adjust **T1004** for minimum indication on the AF millivoltmeter. Then increase the output level of the signal generator slightly and adjust **T1004** again, so as to ensure maximum notching of the image.

### *Noise Blanker Adjustment*

- Connect the DC voltmeter to **TP1043**. Tune the transceiver to 51.995 MHz and inject an RF signal from the signal generator at 20 dB $\mu$  output.
- Activate the noise blanker, and adjust **T1027** and **T1031** for minimum indication on the DC voltmeter connected to **TP1043**.

## Power Amplifier Adjustment (Lot. 1 ~ 68)

### HF/50 MHz Idling Current Adjustment

- Tune the transceiver to any HF band, or to the 50 MHz band.
- Disconnect the jumper between **TP3021** and **TP3022**.
- Connect the ammeter between **TP3021** and **TP3022**.
- Turn **VR3002** fully counterclockwise.
- Press the PTT, and adjust **VR3002** for an indication of 100 mA ( $\pm 10$  mA) on the ammeter.
- Disconnect the ammeter, and re-connect **TP3021** and **TP3022**.

### V/UHF Idling Current Adjustment

- Tune the transceiver to the 430 MHz band.
- Connect the ammeter between **TP3021** and **TP3022**.
- Connect the ammeter between **TP3021** and **TP3022**.
- Turn **VR3001** fully counterclockwise.
- Press the PTT, and adjust **VR3001** for an indication of 300 mA ( $\pm 10$  mA) on the ammeter.
- Disconnect the ammeter, and re-connect **TP3021** and **TP3022**.

## Directional Coupler Balance Adjustment

- Terminate the antenna jack into a 50-Ohm dummy load. Set the mode to CW, and connect the DC voltmeter to **TP3001**.
- Tune the transceiver to the 28 MHz band, and key the transceiver.
- Adjust **TC3002** for minimum indication on the DC voltmeter.
- Tune the transceiver to 439.995 MHz, and key the transceiver.
- Adjust **VR3003** for minimum indication on the DC voltmeter.
- Leave the transceiver on 439.995 MHz band and key the transceiver.
- Adjust **TC3001** for maximum indication on the RF Power meter.

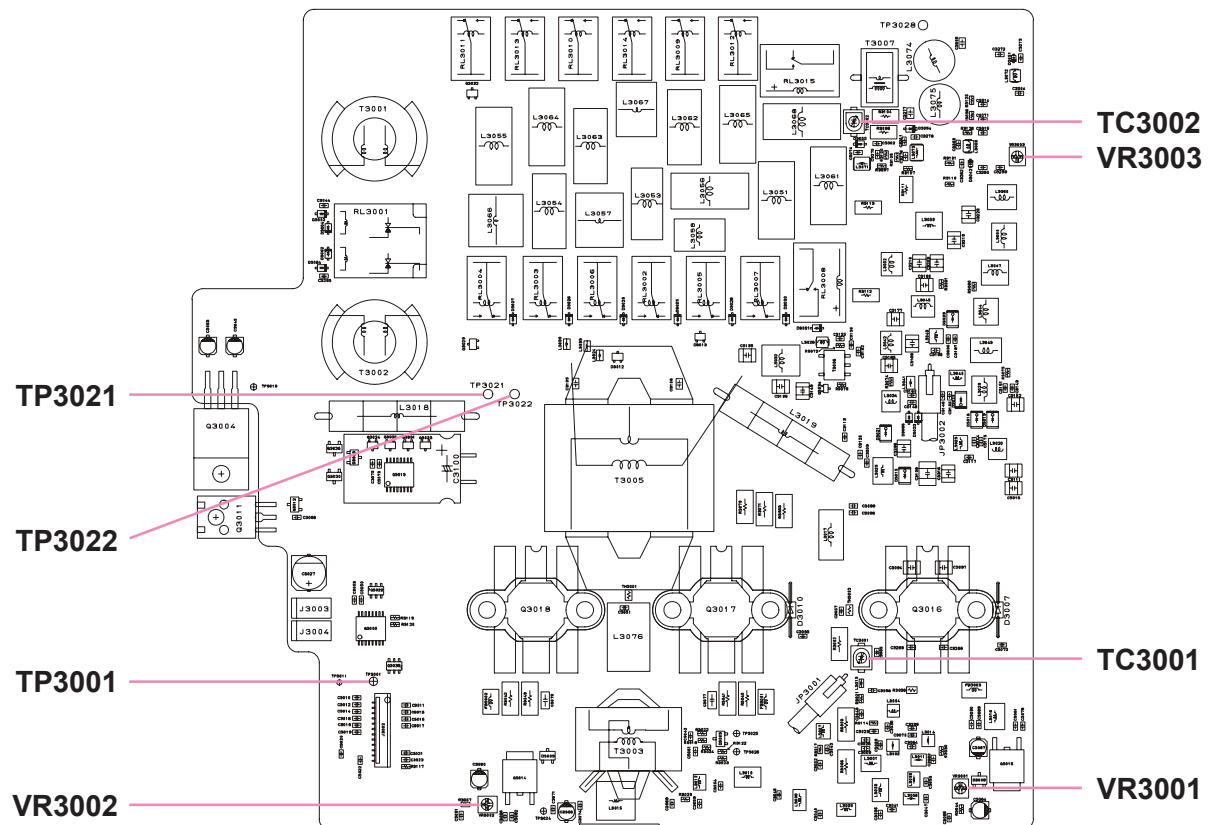

**PA Unit (Lot. 1 ~ 68) Alignment Points**

# Alignment

## Power Amplifier Adjustment (Lot. 69 ~)

### HF/50 MHz Idling Current Adjustment

- Tune the transceiver to any HF band, or to the 50 MHz band.
- Disconnect the wire jumper from **TP3021** and **TP3022** on the PA Unit, then connect the ammeter between **TP3021** (+) and **TP3022** (-).
- Turn **VR3001** fully counterclockwise.
- Press the PTT, and adjust **VR3001** for an indication of 600 mA ( $\pm 10$  mA) on the ammeter.
- Disconnect the ammeter, and re-connect **TP3021** and **TP3022** using the wire jumper.

### V/UHF Idling Current Adjustment

- Tune the transceiver to the 430 MHz band.
- Disconnect the wire jumper from **TP3021** and **TP3022** on the PA Unit, then connect the ammeter between **TP3021** (+) and **TP3022** (-).
- Turn **VR3002** fully counterclockwise.
- Press the PTT, and adjust **VR3002** for an indication of 1000 mA ( $\pm 50$  mA) on the ammeter.
- Disconnect the ammeter, and re-connect **TP3021** and **TP3022** using the wire jumper.

## Directional Coupler Balance Adjustment

- Terminate the antenna jack into a 50-Ohm dummy load. Set the mode to CW, and connect the DC voltmeter to **TP3001**.
- Tune the transceiver to the 28 MHz band, and key the transceiver.
- Adjust **TC3002** for minimum indication on the DC voltmeter.
- Tune the transceiver to 439.995 MHz, and key the transceiver.
- Adjust **VR3003** for minimum indication on the DC voltmeter.
- Leave the transceiver on 439.995 MHz band and key the transceiver.
- Adjust **TC3001** for maximum indication on the RF Power meter.

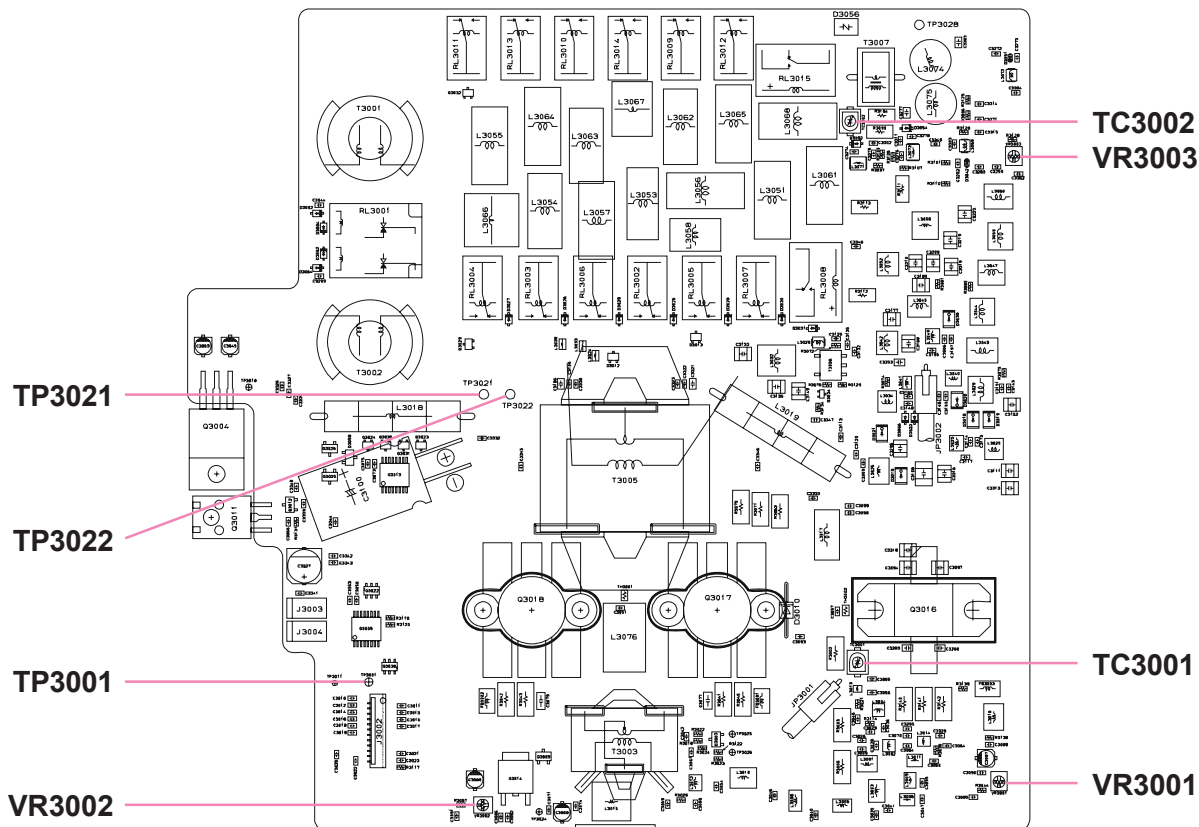

**PA Unit (Lot. 69 ~) Alignment Points**



## Battery Indicator Alignment

- Connect a DC power supply to pin 4 of **JP4007**, and connect pin 6 to the ground lead from the power supply.
- Adjust the power supply voltage exactly to 11.0 V.
- Adjust **VR4001** until you see an orange blink on the **BATT-A** indicator.

## Software Menu Alignment

The antenna connector should be connected to a dummy load (in cases where transmission is involved) or the signal generator (in the case of reception). General alignment conditions are as follows unless otherwise noted.

<b>AF-gain knob:</b>	Center
<b>RF-gain knob:</b>	Fully clockwise
<b>SQL:</b>	Fully counterclockwise
<b>ATT/IPO/CTCSS/DCS:</b>	Off
<b>Output power:</b>	High
<b>AGC:</b>	Auto
<b>Break-in:</b>	On
<b>CW Keyer:</b>	Off
<b>VOX:</b>	Off

Press and hold in the Multi Function Keys **[A]**, **[B]**, **[C]** simultaneously and turn on the transceiver while holding them in; the alignment menu will then be activated (you will hear a “diddle-diddle-diddle” opening tone sequence to confirm that the alignment menu has been activated).

In the alignment procedures, each alignment parameter is selected by rotating the **MAIN** dial. Each Alignment item is selected by rotating the **MEM/WFO CH** knob.

To store the alignment parameters when you are satisfied with the adjustment, press the **[MENU]** key for longer than a half second.

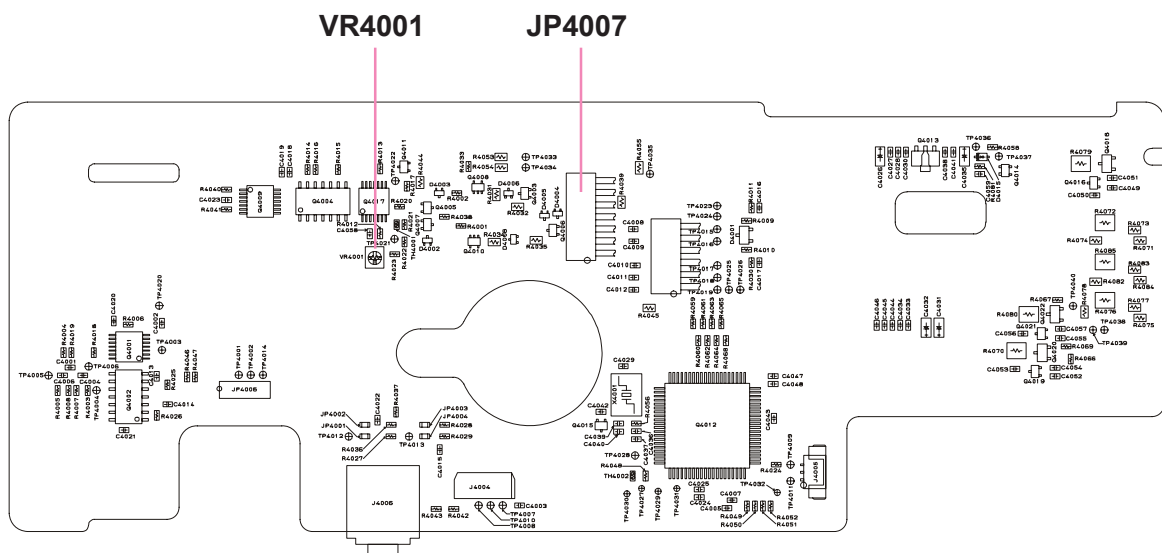

# Alignment

## *RX Gain Adjustment*

- Select the CW mode. Tune the transceiver to the 1.8 MHz band. Select “**HF1RXG**” in the menu by rotating the **MEM/VFO CH** knob, if necessary. Inject an RF signal from the signal generator at 9 dB $\mu$  output.
- Adjust the “**HF1RXG**” parameter by rotating the main dial to the point where the first dot of the S-meter (S1) appears.
- The other RX gain adjustments (see the chart below) should be performed in the same way. The output levels of the signal generator at each frequency are shown below.

Menu Frequency	Output Level of SG	
<b>01: HF1RXG</b>	1.8 MHz Band	9 dBu
<b>02: HF2RXG</b>	7 MHz Band	9 dBu
<b>03: HF#RXG</b>	21 MHz Band	6 dBu
<b>04: 50MRXG</b>	50 MHz Band	0 dBu
<b>05: VHFRXG</b>	144 MHz Band	0 dBu
<b>06: UFFRXG</b>	430 MHz Band	0 dBu

## *SSB S-Meter Adjustment*

- Tune the transceiver to the 21 MHz band in the CW mode. Inject an RF signal from the signal generator at 36 dB $\mu$  output.
- Select menu item “**07: SSB-S9**” and press the [A] key to set this parameter.
- Tune the transceiver to the 21 MHz band in the CW mode. Inject an RF signal from the signal generator at 86 dB $\mu$  output.
- Select menu item “**08: SSB-FS**” and press the [A] key to set this parameter.

## *FM S-Meter Adjustment*

- Tune the transceiver to the 144 MHz band in the FM mode. Inject an RF signal from the signal generator at 0 dB $\mu$  output, with  $\pm 3.5$  kHz deviation FM Modulation of a 1 kHz tone.
- Select menu item “**09: FM-S1**” and press the [A] key to set this parameter.
- Increase the output level of the signal generator up to 25 dB $\mu$ . Select menu item “**10: FM-FS**” and press [A] key to set this parameter.

## *FM Center Meter Adjustment*

- Tune the transceiver to the 144 MHz band in the FM mode. Inject an RF signal from the signal generator at 10 dB $\mu$  output, with  $\pm 3.5$  kHz deviation FM Modulation of a 1 kHz tone.
- Set the frequency of the signal generator 3 kHz below the receiving frequency of the transceiver. Select menu item “**11: DISC-L**” and press the [A] key to set this parameter.
- Set the frequency of the signal generator 3 kHz above the receiving frequency of the transceiver. Select menu item “**12: DISC-H**” and press the [A] key to set this parameter.

## *FM Squelch Adjustment*

- Tune the transceiver to the 144 MHz band in the FM mode. Confirm that the squelch knob is turned fully counterclockwise.
- Inject an RF signal from the signal generator at -15 dB $\mu$  output, with  $\pm 3.5$  kHz deviation FM Modulation of a 1 kHz tone. Select menu item “**13: FM-TH1**” and press the [A] key to set this parameter. Select menu item “**14: FM-TH2**” and press the [A] key again.
- Inject an RF signal from the signal generator at 0 dB $\mu$  output, with  $\pm 3.5$  kHz deviation FM Modulation of a 1 kHz tone. Select menu item “**15: FM-TI1**” and press the [A] key to set this parameter. Select menu item “**16: FM-TI2**” and press the [A] key again.

## *Power Supply Voltage Display Adjustment*

- Tune the transceiver to the 144 MHz band in the FM mode. Confirm that the power supply voltage is 13.8 V ( $\pm 0.1$  V).
- Select menu item “**17: VCC**” and adjust this parameter such that “**138**” is displayed on the LCD.

## Over-current Protection Adjustment

- Set the mode to CW. Select menu item “**18: HF1-IC.**” Tune the transceiver to the 1.8 MHz band and key the transceiver. Adjust this parameter for 140 Watts of transmission power.
- Select menu item “**19: HF2-IC.**” Tune the transceiver to the 7 MHz band and key the transceiver. Adjust this parameter for 130 Watts of transmission power.
- Select menu item “**20: HF3-IC.**” Tune the transceiver to the 21 MHz band and key the transceiver. Adjust this parameter for 130 Watts of transmission power.
- Select menu item “**21: 50M-IC.**” Tune the transceiver to the 50 MHz band and key the transceiver. Adjust this parameter for 120 Watts of transmission power.
- Select menu item “**22: VHF-IC.**” Tune the transceiver to the 144 MHz band and key the transceiver. Adjust this parameter for 60 Watts of transmission power.
- Select menu item “**23: UHF-IC.**” Tune the transceiver to 430.000 MHz and key the transceiver. Adjust this parameter for 25 Watts of transmission power.

## RF Power Adjustment

- Tune the transceiver to the 1.8 MHz band in the CW mode. Select menu item “**24: HF1-MAX.**” Key the transmitter, and adjust this parameter for 100 Watts ( $\pm 5$  W) of transmission power.
- Select menu item “**25: HF1-MID2.**” Key the transmitter, and confirm that the output power is 50 W ( $\pm 5$ W). In case the transmission power is not within the specified tolerance, adjust this parameter for 50 W ( $\pm 5$  W) of transmission power.
- Select menu item “**26: HF1-MID1.**” Key the transmitter, and confirm that the output power is 10 W ( $\pm 1$  W). In case the power is not within the specified tolerance, adjust this parameter for 10 W ( $\pm 1$  W) of transmission power.
- Select menu item “**27: HF1-MIN.**” Key the transmitter, and confirm that the output power is 5 W ( $\pm 1$  W). In case the power is not within the specified tolerance, adjust this parameter for 5 W ( $\pm 1$  W) of transmission power.
- The other RF power adjustment menus, [HF2-\*\*] and [HF3-\*\*], should be adjusted in the same manner as shown above for the 7 MHz and 21 MHz bands respectively.
- Tune the transceiver to the 50 MHz band in the CW mode. Select menu item “**36: 50M-MAX.**” Key the transmitter, and adjust this parameter for 100 W ( $\pm 5$  W) of transmission power.
- Select menu item “**37: 50M-MID2.**” Key the transmitter, and confirm that the output power is 50 W ( $\pm 5$  W). In case the transmission power is not within the specified tolerance, adjust this parameter for 50 W ( $\pm 5$  W) of transmission power.
- Select menu item “**38: 50M-MID1.**” Key the transmitter, and confirm that the output power is 20 W ( $\pm 2$ W). In case the power is not within the specified tolerance, adjust this parameter for 20 W ( $\pm 2$  W) of transmission power.
- Select menu item “**39: 50M-MIN.**” Key the transmitter, and confirm that the output power is 5 W ( $\pm 1$  W). In case the power is not within the specified tolerance, adjust this parameter for 5 W ( $\pm 1$  W) of transmission power.
- Tune the transceiver to the 144 MHz band in the CW mode. Select menu item “**40: VHF-MAX.**” Key the transmitter, and adjust this parameter for 50 W ( $\pm 2.5$  W) of transmission power.
- Select menu item “**41: VHF-MID.**” Key the transmitter, and confirm that the output power is 20 W ( $\pm 2$  W). In case the transmission power is not within the specified tolerance, adjust this parameter for 20 W ( $\pm 2$  W) of transmission power.

# Alignment

- Select menu item “**42: VHF-MIN.**” Key the transmitter, and confirm that the output power is 5 W ( $\pm 1$  W). In case the power is not within the specified tolerance, adjust this parameter for 5 W ( $\pm 1$  W) of transmission power.
- Tune the transceiver to the 430 MHz band in the CW mode. Select the menu item “**43: UHF-MAX.**” Key the transmitter, and adjust this parameter for 22 W ( $\pm 1$  W) of transmission power.
- Select menu item “**44: UHF-MID.**” Key the transmitter, and confirm that the output power is 2 W ( $\pm 0.3$  W). In case the transmission power is not within the specified tolerance, adjust this parameter for 2 W ( $\pm 0.3$  W) of transmission power.

## *TX Gain Adjustment*

- Select the USB mode. Inject a 1 mV audio signal at a frequency of 1 kHz from the AF generator into the **MIC** jack.
- Tune the transceiver to the 1.8 MHz band and key the transmitter. Select menu item “**45: HF1TXG**” and adjust this parameter for 70 W ( $\pm 10$  W) of transmission power.
- The other TX gain adjustment menus, “**46: HF2TXG**”, “**47: HF3TXG**”, and “**48: 50MTXG**”, should be adjusted in the same manner as detailed above on the 7 MHz, 21 MHz, and 50 MHz bands, respectively.
- Tune the transceiver to the 144 MHz band and key the transmitter. Select menu item “**49: VHFTXG**” and adjust this parameter for 35 W ( $\pm 5$  W) of transmission power.
- Tune the transceiver to the 430 MHz band and key the transmitter. Select menu item “**50: UHFTXG**” and adjust this parameter for 14 W ( $\pm 2$  W) of transmission power.

## *ALC Meter Adjustment*

- Tune the transceiver to the 21 MHz band in the USB mode. Select menu item “**51: ALC-1.**” Key the transceiver without microphone input and press the **[A]** key. Now, a value which the microprocessor computes will be displayed on the LCD.
- Rotate the main dial to adjust this parameter to a reading four digits lower than the parameter value displayed in the previous step.
- After setting the parameter, confirm that all the dots of the ALC meter have gone out.
- Select menu item “**52: ALC-M.**” Inject a 4.0mV AF signal at 1 kHz audio frequency from an audio generator and key the transceiver.
- Press the **[A]** key and confirm that 9 dots of the ALC meter light up on the LCD.

## *Reverse ALC Adjustment*

- Set the mode on CW, and connect a 150-Ohm dummy load to the antenna connector.
- Key the transceiver on the 1.8 MHz band, and select menu item “**53: HF1-RV.**” adjust this parameter for an “S-8” S-meter reading on the LCD.
- The other reverse ALC adjustment menus, “**54: HF2-RV**”, “**55: HF3-RV**”, and “**56: 50M-RV**”, should be adjusted in the same manner as shown above on the 7 MHz, 21 MHz, and 50 MHz bands, respectively.
- Key the transceiver on the 144 MHz band and select menu item “**57: VHF-RV.**” adjust this parameter for an “S-6” S-meter reading on the LCD.
- Key the transceiver on the 430 MHz band and select menu item “**58: UHF-RV.**” adjust this parameter for an “S-3” S-meter reading on the LCD.

## *Carrier Level Adjustment*

- Tune the transceiver to the 21 MHz band in the CW mode. Connect a 50-Ohm dummy load to the antenna connector. Select menu item “**59: CW-CAR**” and key the transceiver.
- Set this parameter such that the center of the meter on the LCD lights up.
- Connect the oscilloscope to the antenna connector via an appropriate attenuator.
- Set the mode to AM. Select menu item “**60: AM-CAR.**” Inject a 1.5 mV audio signal at a frequency of 1 kHz from the audio generator into the microphone jack.
- Key the transceiver and adjust this parameter for 33% AM modulation on the oscilloscope.

## *FM Modulation Adjustment*

- Tune the transceiver to the 144 MHz band in the FM mode. Connect the FM linear detector to the antenna connector via an appropriate attenuator. Select menu item “**61: DEV-W.**” Inject a 15 mV audio signal at 1 kHz from the audio generator.
- Key the transceiver and adjust this parameter for a maximum deviation of  $\pm 4.5$  kHz ( $\pm 0.2$  kHz) on the FM linear detector.
- Change the menu item to “**62: DEV-N.**” Key the transceiver and adjust this parameter for maximum deviation of  $\pm 2.25$  kHz ( $\pm 0.1$  kHz) on the FM linear detector.
- Change the menu item to “**63: M-MTR.**” Key the transceiver and set this parameter for an “S-9” indication on the S-meter on the LCD.
- Change the menu item to “**64: DTMF.**” Key the transceiver with DTMF signal input (press any DTMF key on the MH-36E8J microphone) and adjust this parameter for a maximum deviation of  $\pm 3.5$  kHz ( $\pm 0.3$  kHz) on the FM linear detector.
- Change the menu item to “**65: CTCSS.**” Key the transceiver without microphone input and adjust this parameter for a maximum deviation of  $\pm 0.7$  kHz ( $\pm 0.1$  kHz) on the FM linear detector.
- Change the menu item to “**66: DCS.**” Key the transceiver without microphone input and adjust this parameter for a maximum deviation of  $\pm 0.7$  kHz ( $\pm 0.2$  kHz) on the FM linear detector.

## *SSB Carrier Point Adjustment*

- Tune the transceiver to the 21 MHz band. Select menu item “**67: LSB-CP.**” Set the mode to LSB, and inject a 1.0 mV audio signal from the audio generator into the **MIC** jack.
- Lower the audio frequency down to 400 Hz and adjust this parameter for 20 W output power from the transceiver.
- Change the audio frequency to 2600 Hz, and confirm that the output power is at least 20 W ( $\pm 2$  W).
- The adjustment for the USB carrier point is performed in the same manner as done for LSB by changing the transmission mode to USB and the menu item to “**68: USB-CP.**”

## *VSWR Adjustment*

- Connect a 100-Ohm dummy load to the antenna connector.
- Tune the transceiver to the 14 MHz band in the CW mode.
- Select menu item “**69: SWR2.**” Key the transceiver and press the [**A**] key to set this parameter.
- Connect a 150-Ohm dummy load to the antenna connector.
- Select menu item “**70: SWR3.**” Key the transceiver and press the [**A**] key to set this parameter.

## *ATAS control voltage confirmation*

- Connect the DC voltmeter to the **ANT** (HF/50 MHz) jack.
- Select menu item “**71: ATAS.**”
- Press the [**A**] key, and confirm that the voltage is 9.0 to 10.1 Volts.
- Press the [**B**] key, and confirm that the voltage is 7.5 to 8.5 Volts.
- Press the [**C**] key, and confirm that the voltage is more than 10.5 Volts.

This completes the internal alignment routine for all bands. To save all settings and exit, press and hold in the [**F**] key for at least 0.5 second.

# *Alignment*

*Note*

Circuit Diagram

MAIN-UNIT (1001-1999)

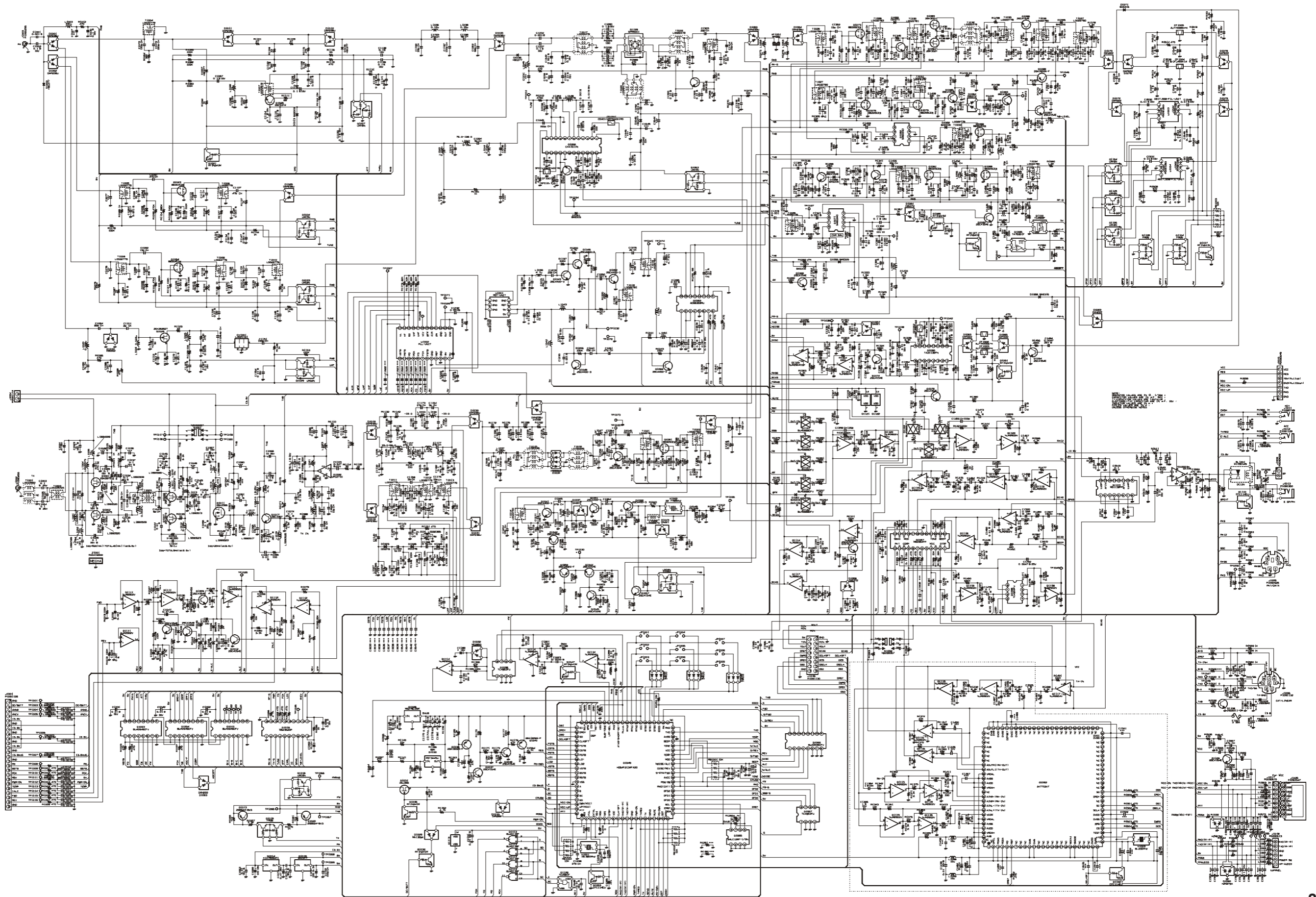

***MAIN Unit (Lot. 1 ~ 3)***

*Note:*



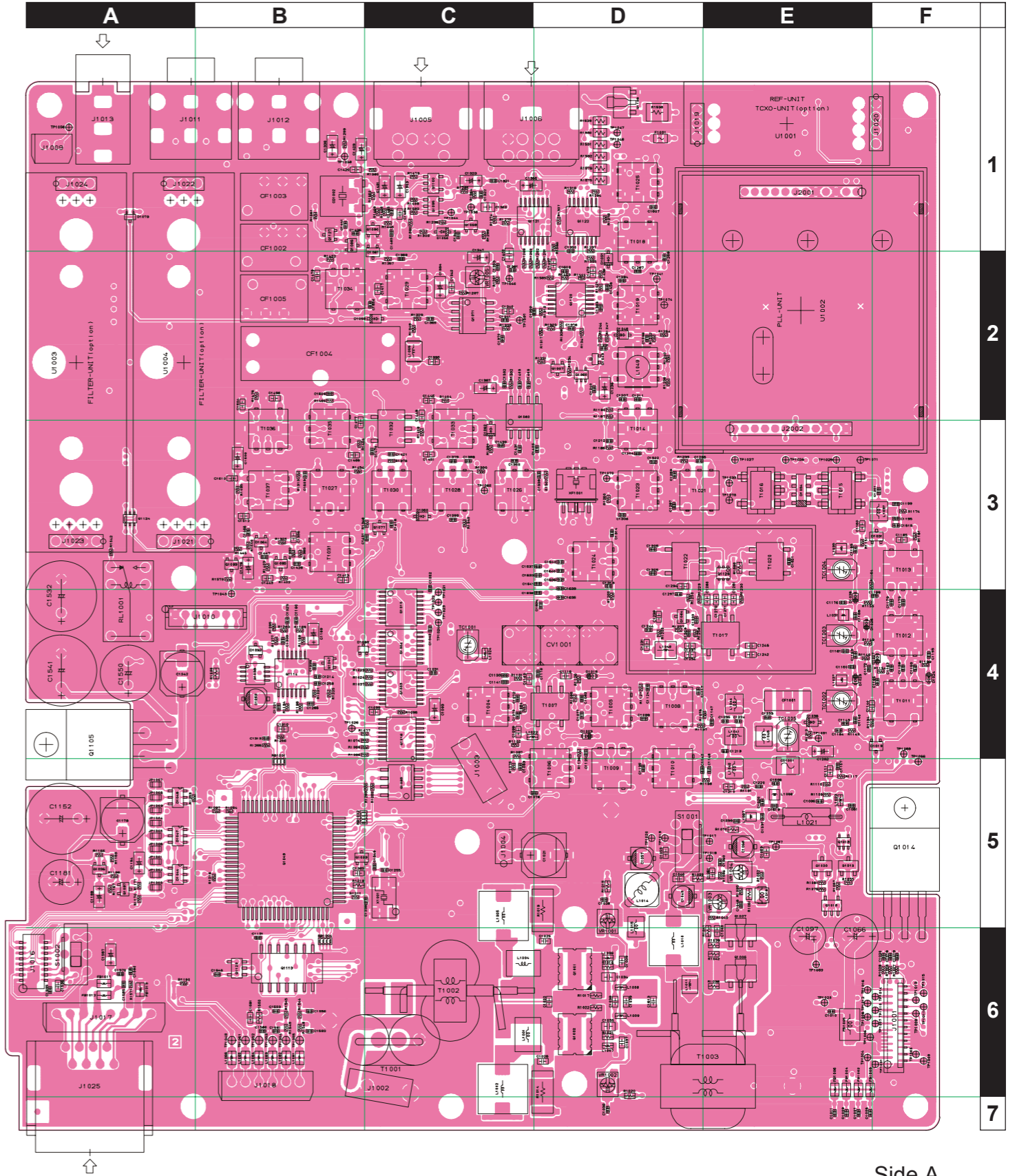
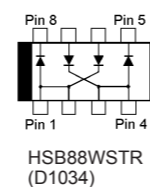
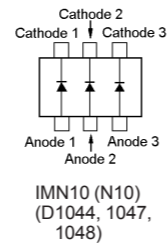
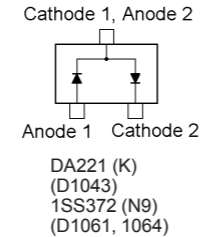
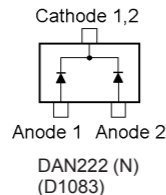
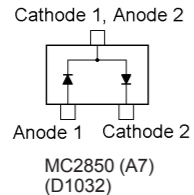
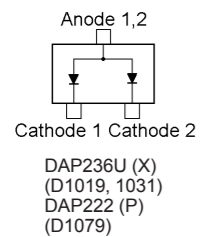
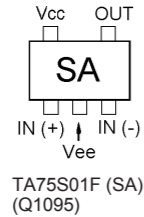
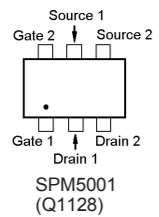
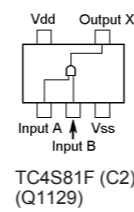
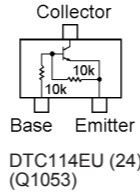
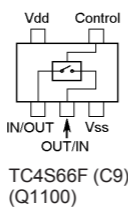
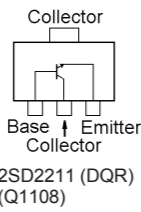
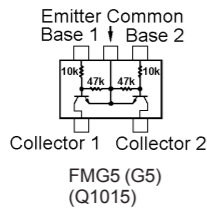
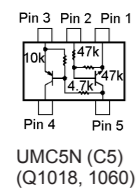
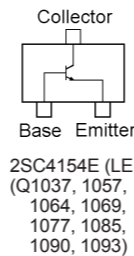
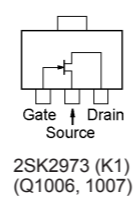
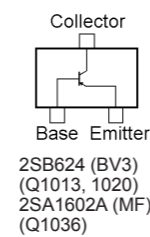
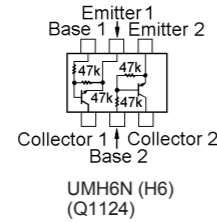
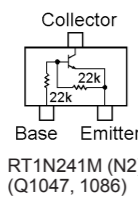
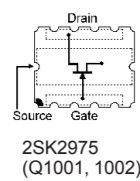
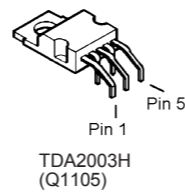
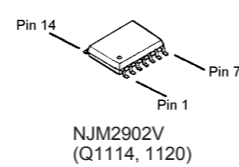
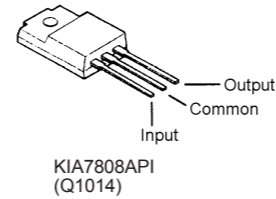
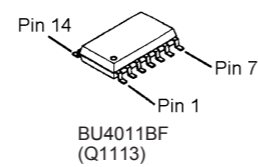
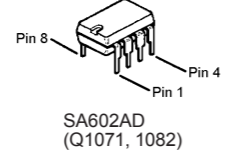
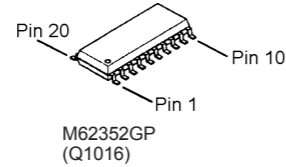
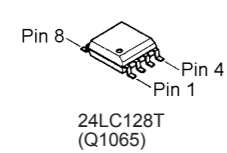
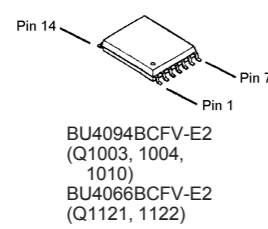
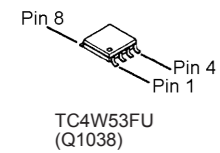
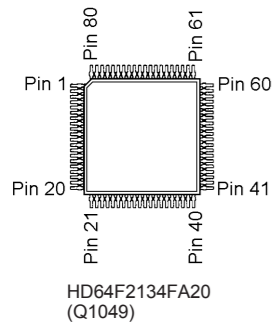

Side A

# MAIN Unit (Lot. 1 ~ 3)

## Parts Layout

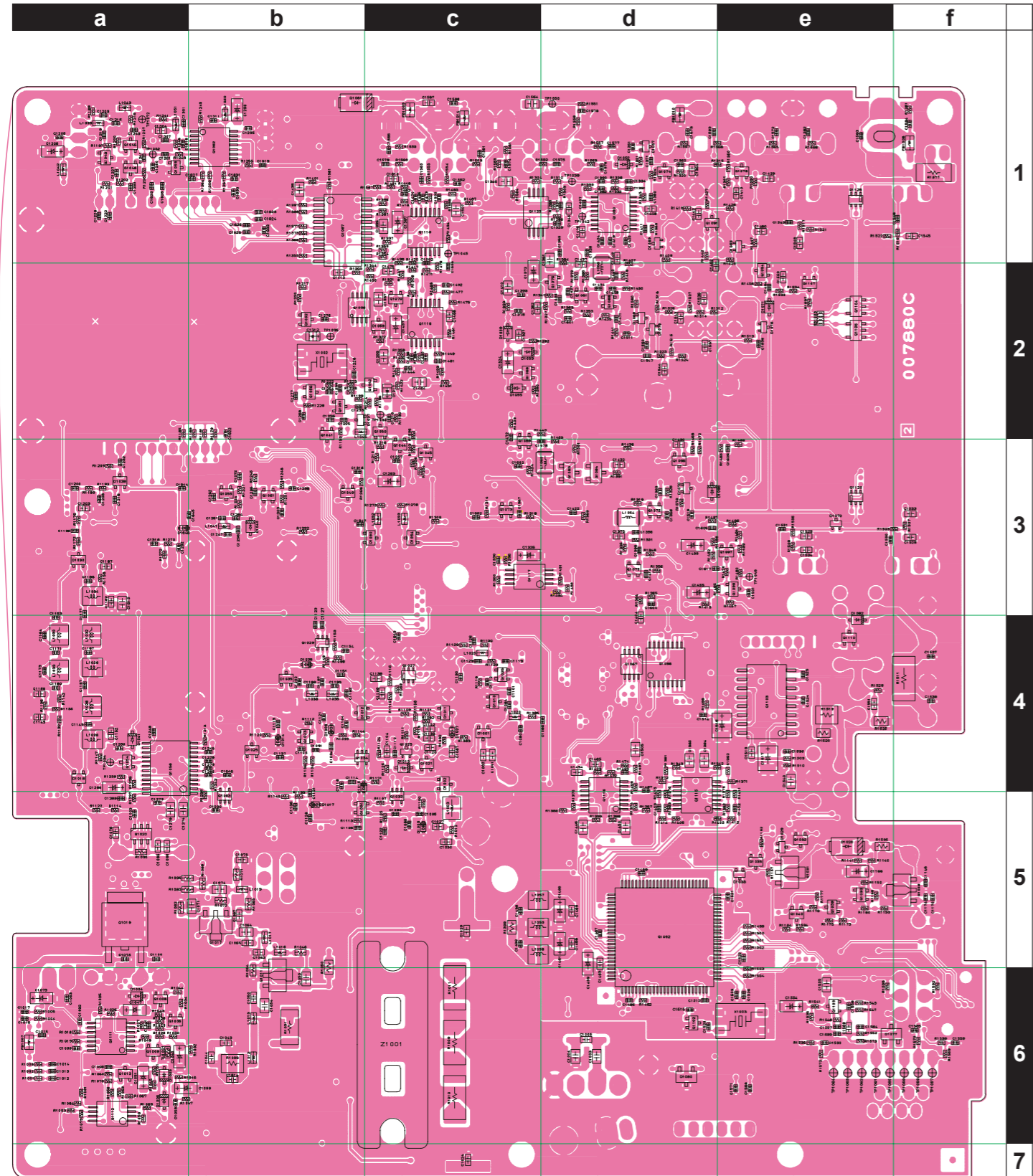

Side B

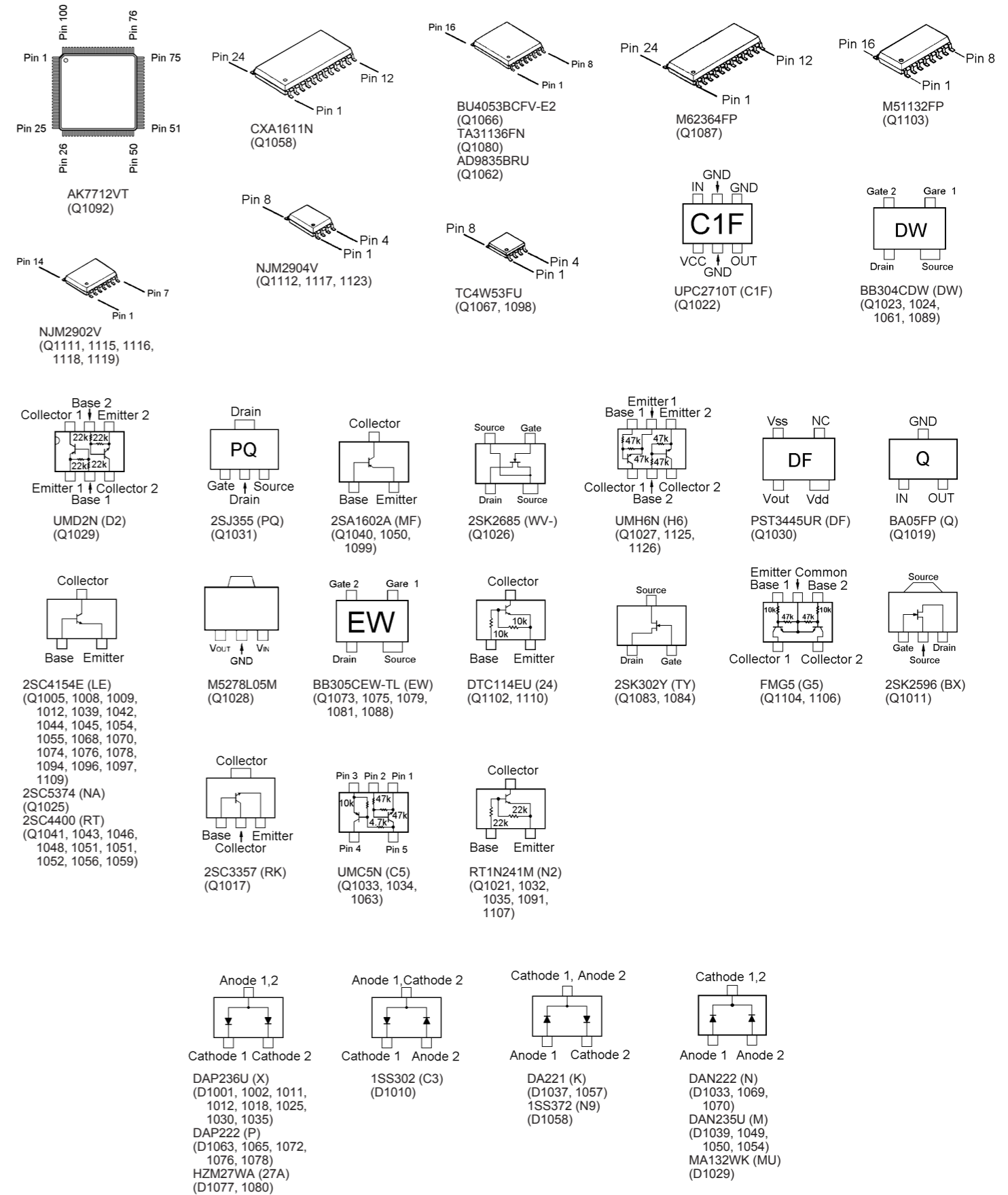

Circuit Diagram

MAIN-UNIT (BPO0B020E)  
1001-1999

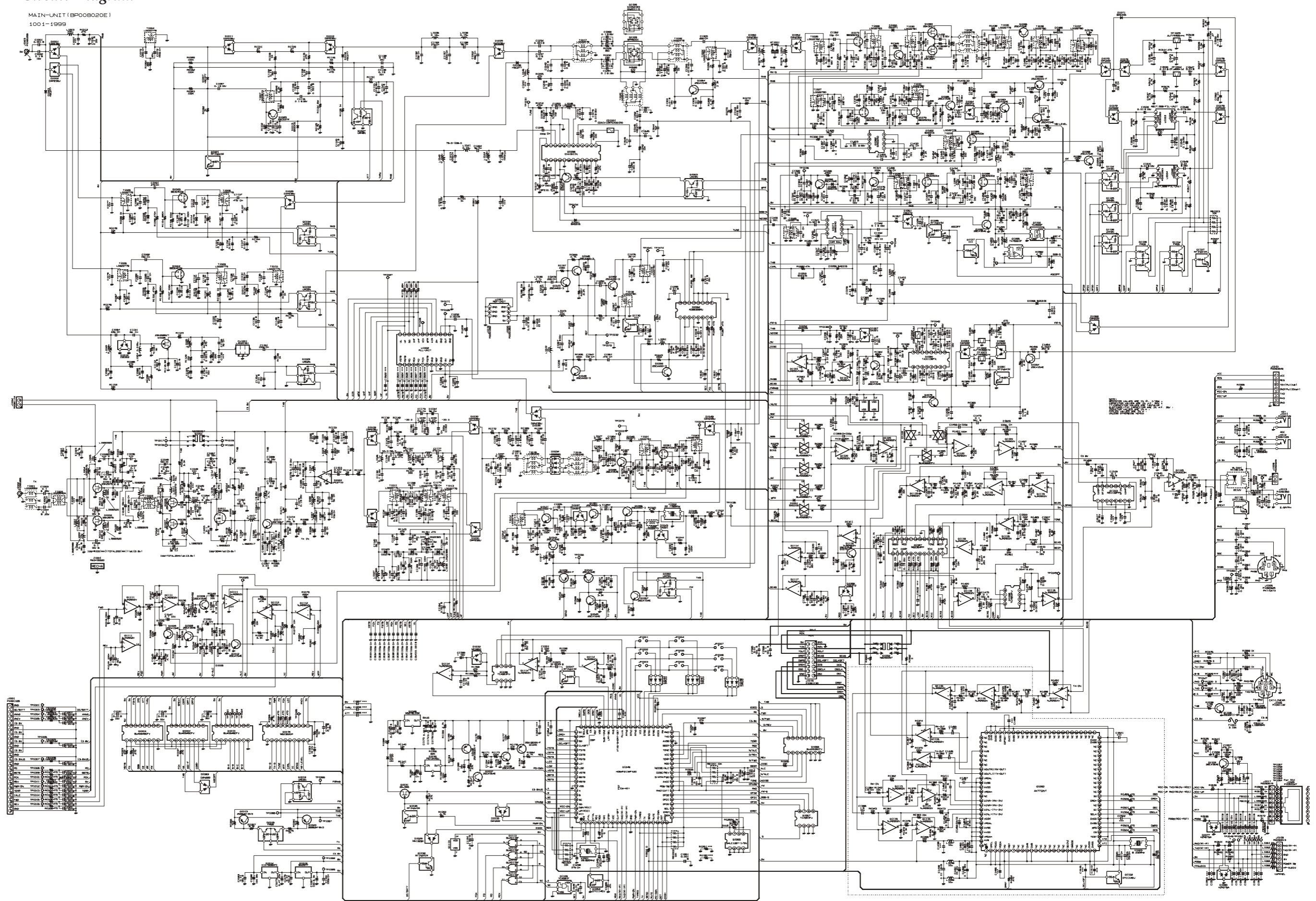

***MAIN Unit (Lot. 4 ~ 24)***

*Note:*

Parts Layout

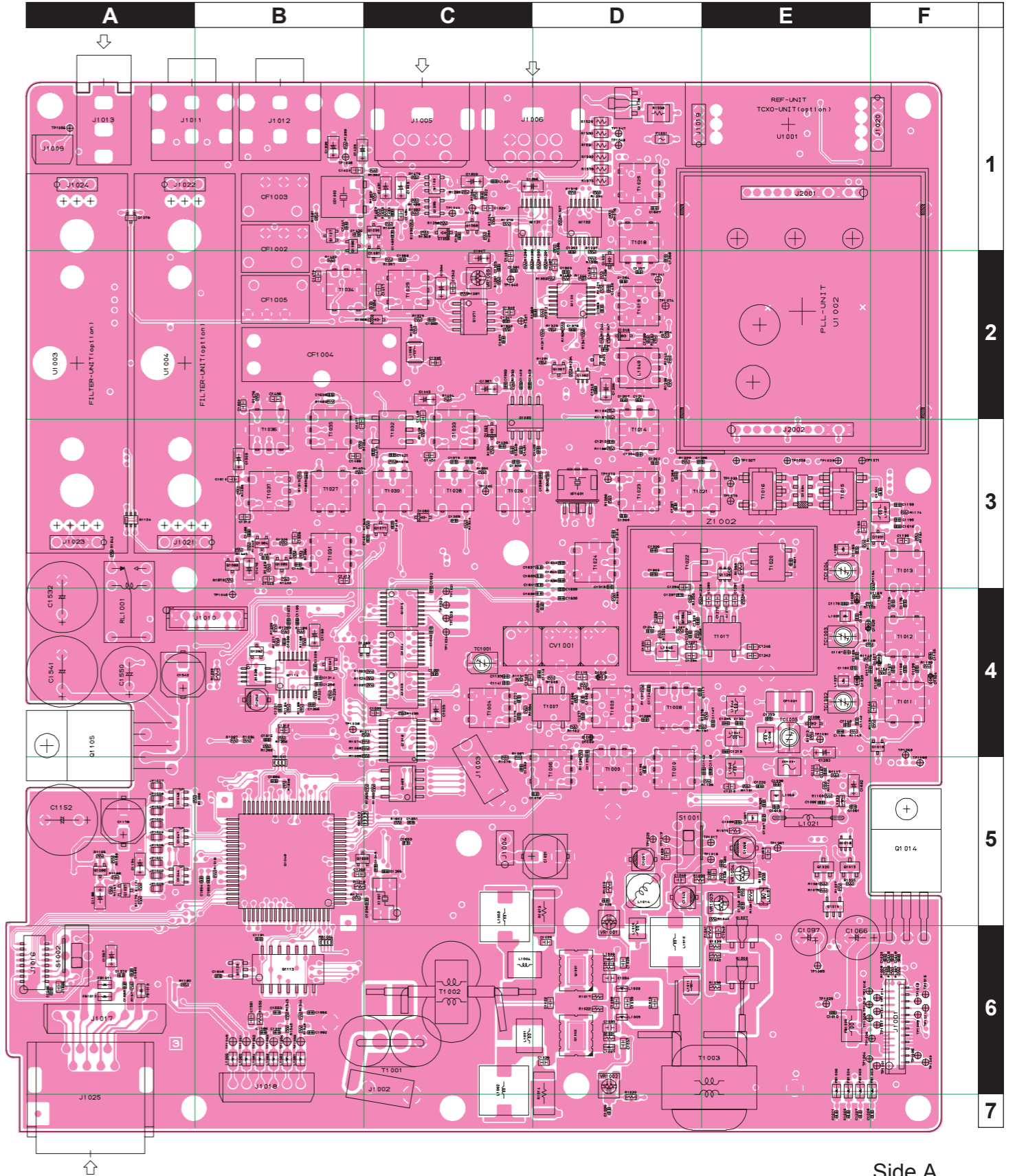

Side A

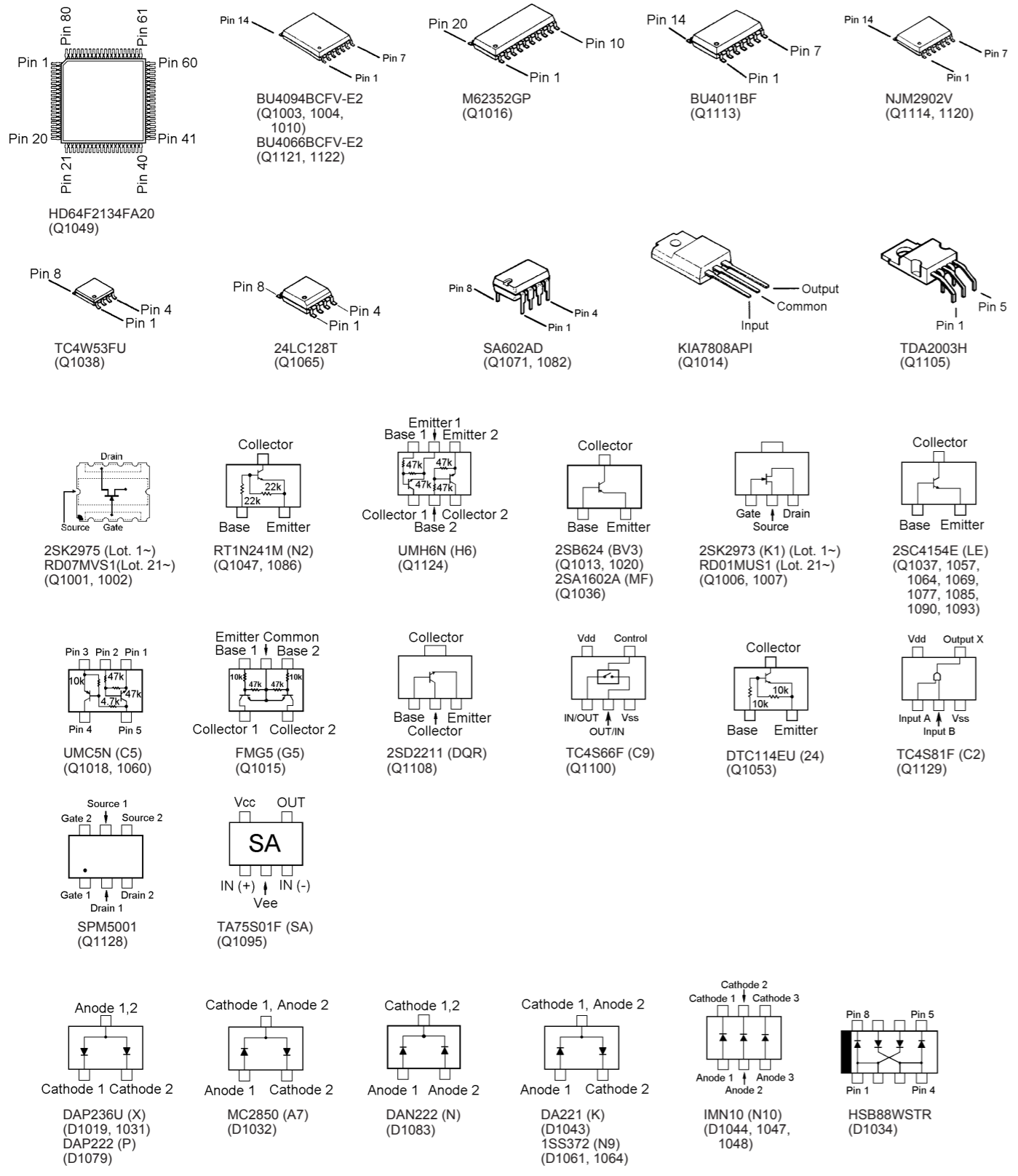

# MAIN Unit (Lot. 4 ~ 24)

## Parts Layout

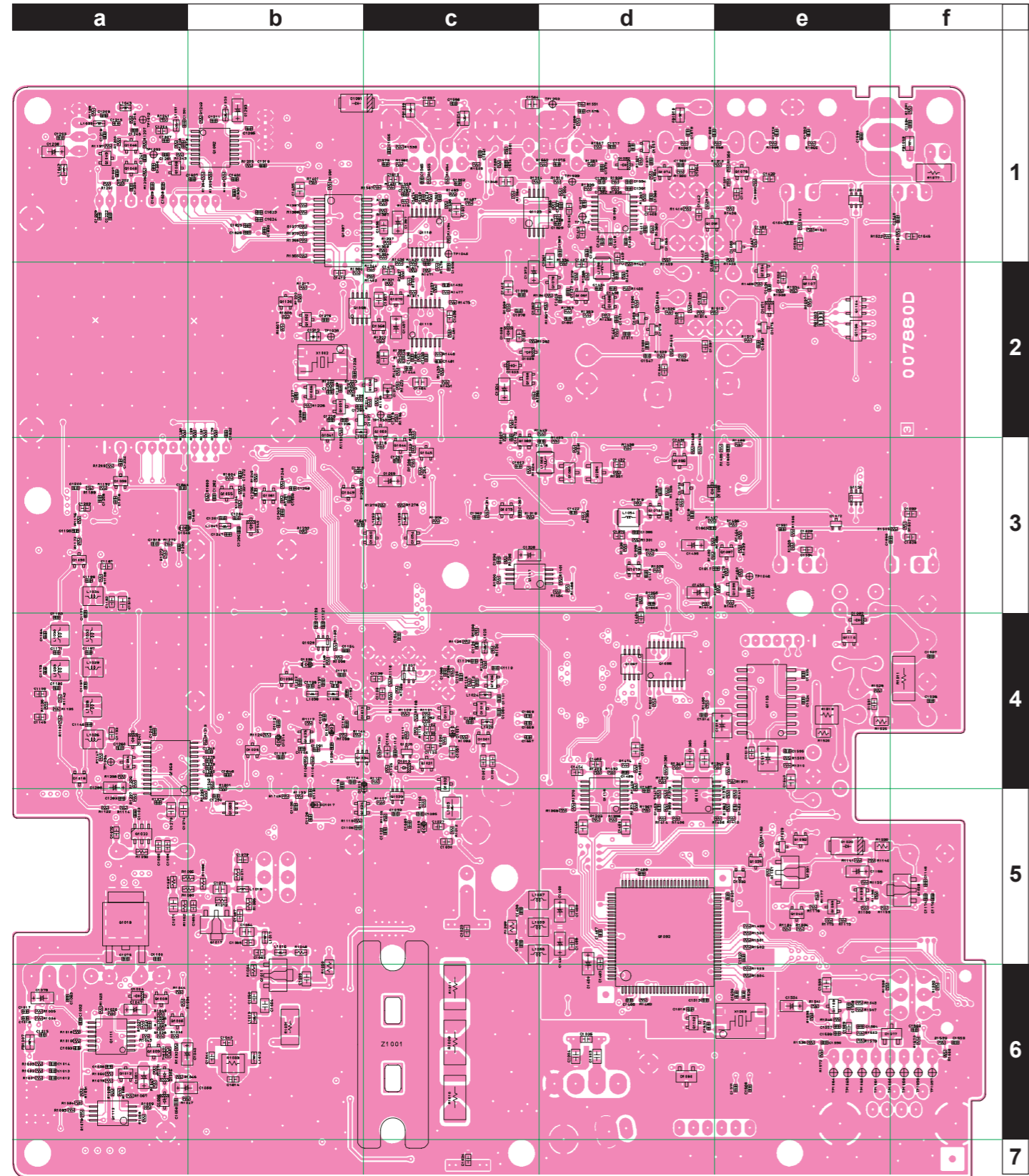

Side B

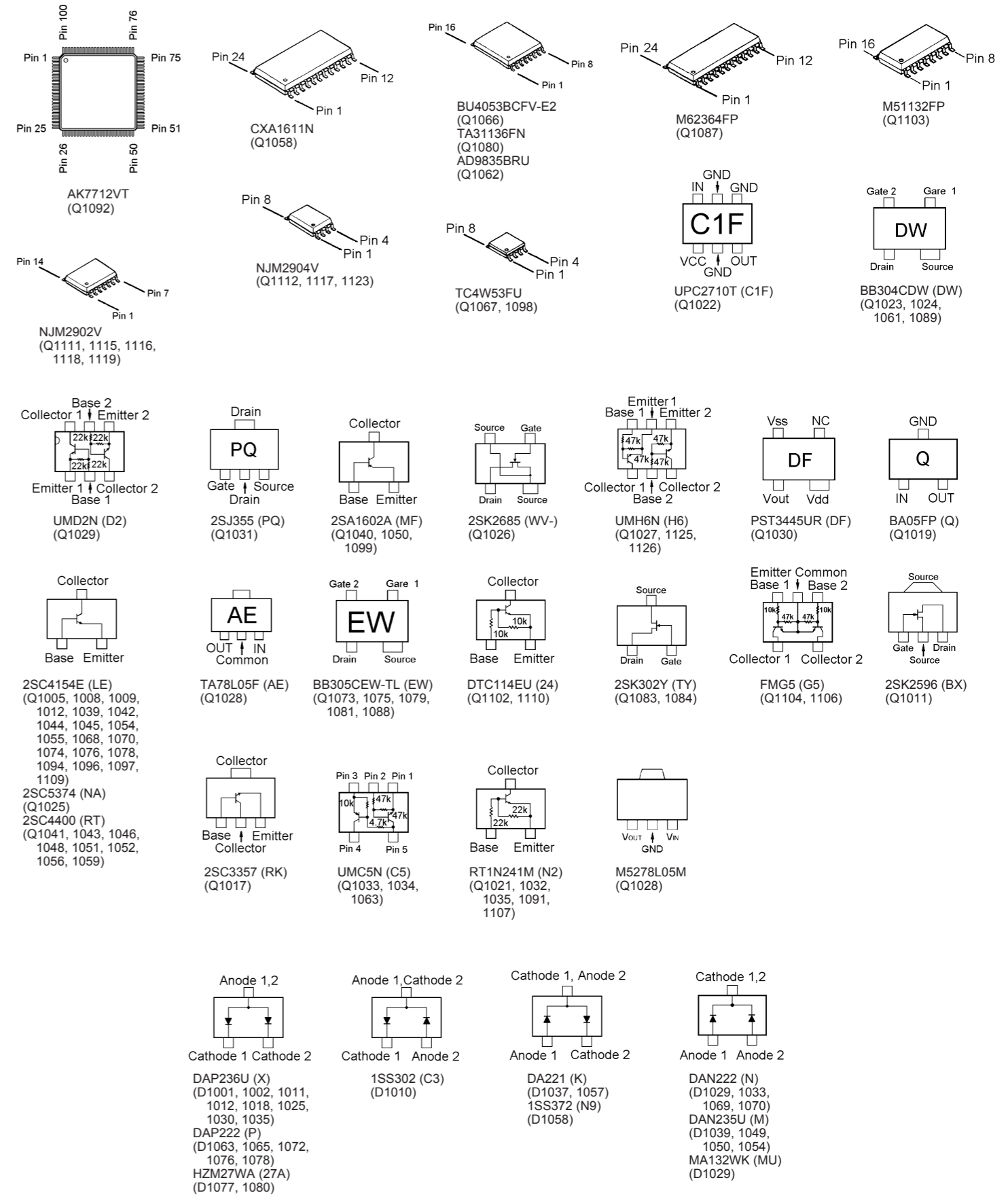

Circuit Diagram

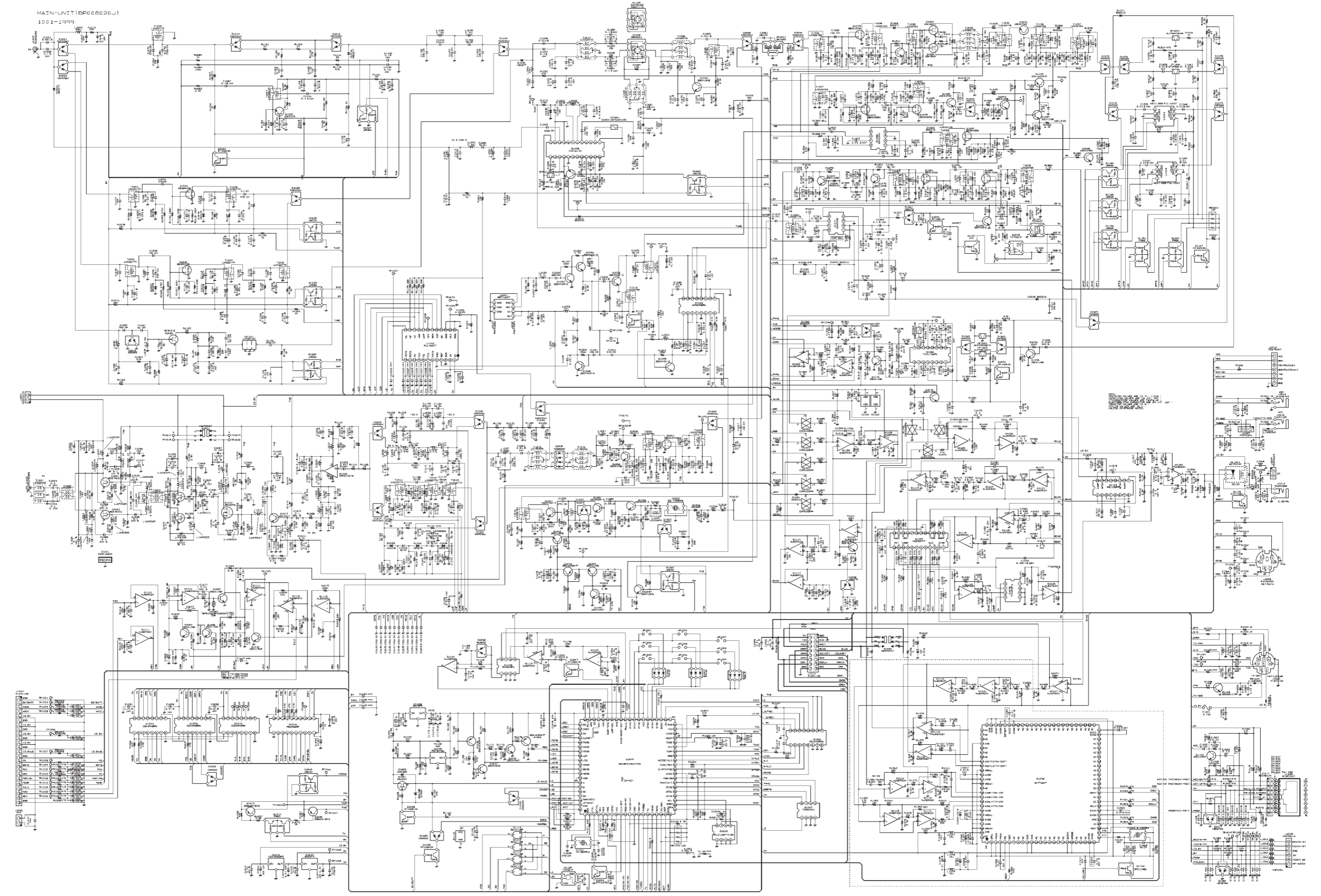

***MAIN Unit (Lot. 25 ~ 49)***

*Note:*



Parts Layout

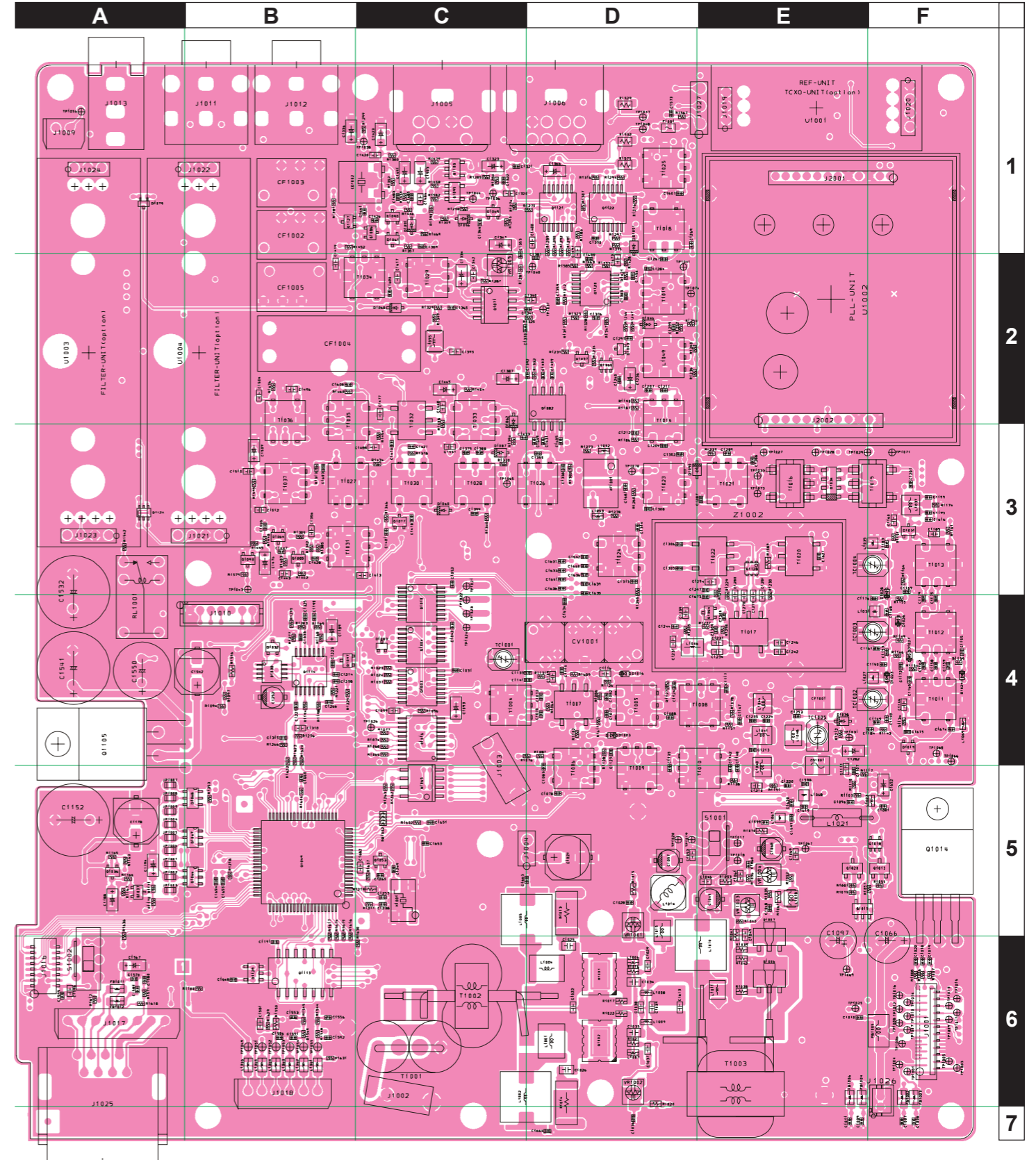
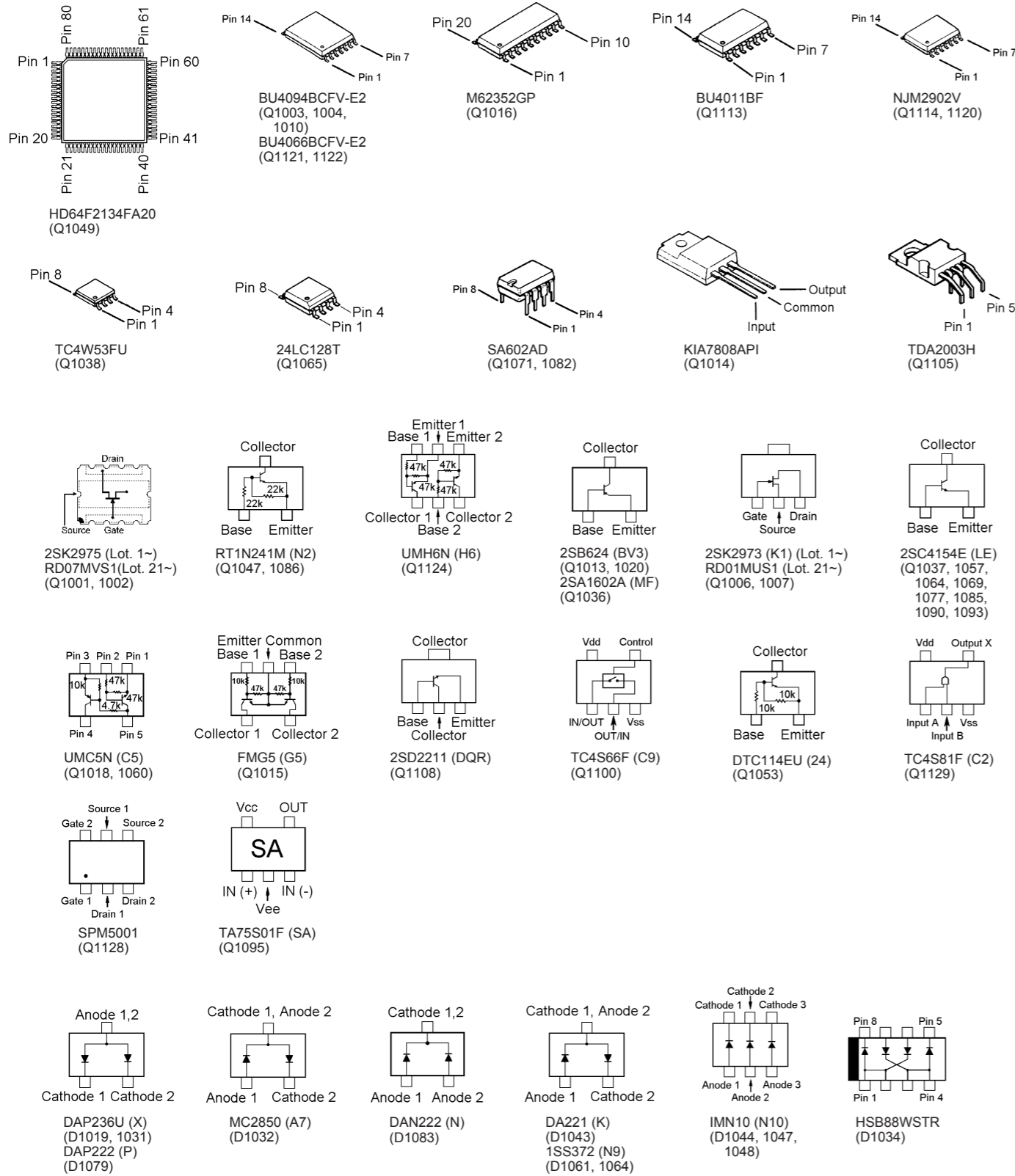

Side A

# MAIN Unit (Lot. 25 ~ 49)

## Parts Layout

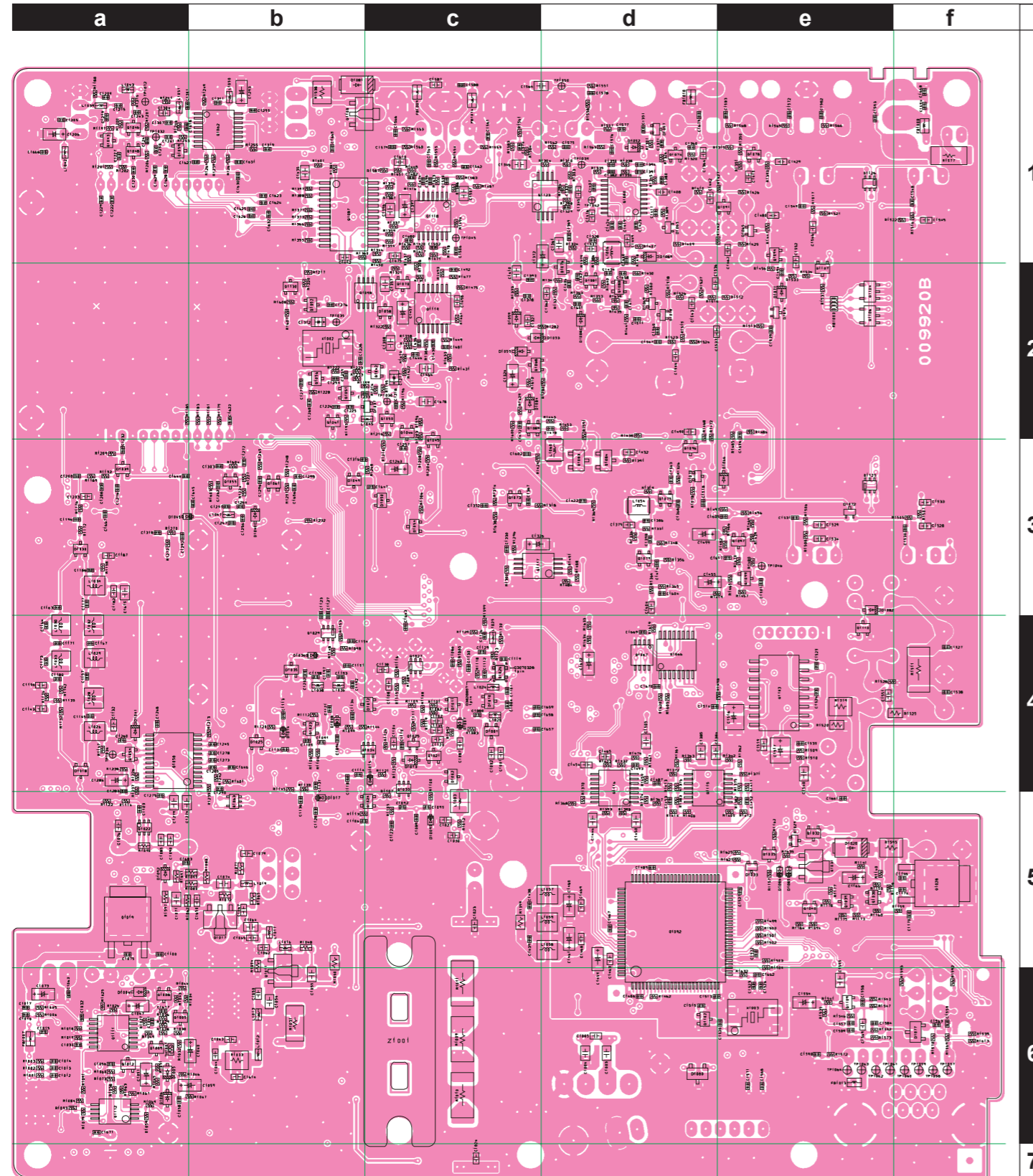

Side B

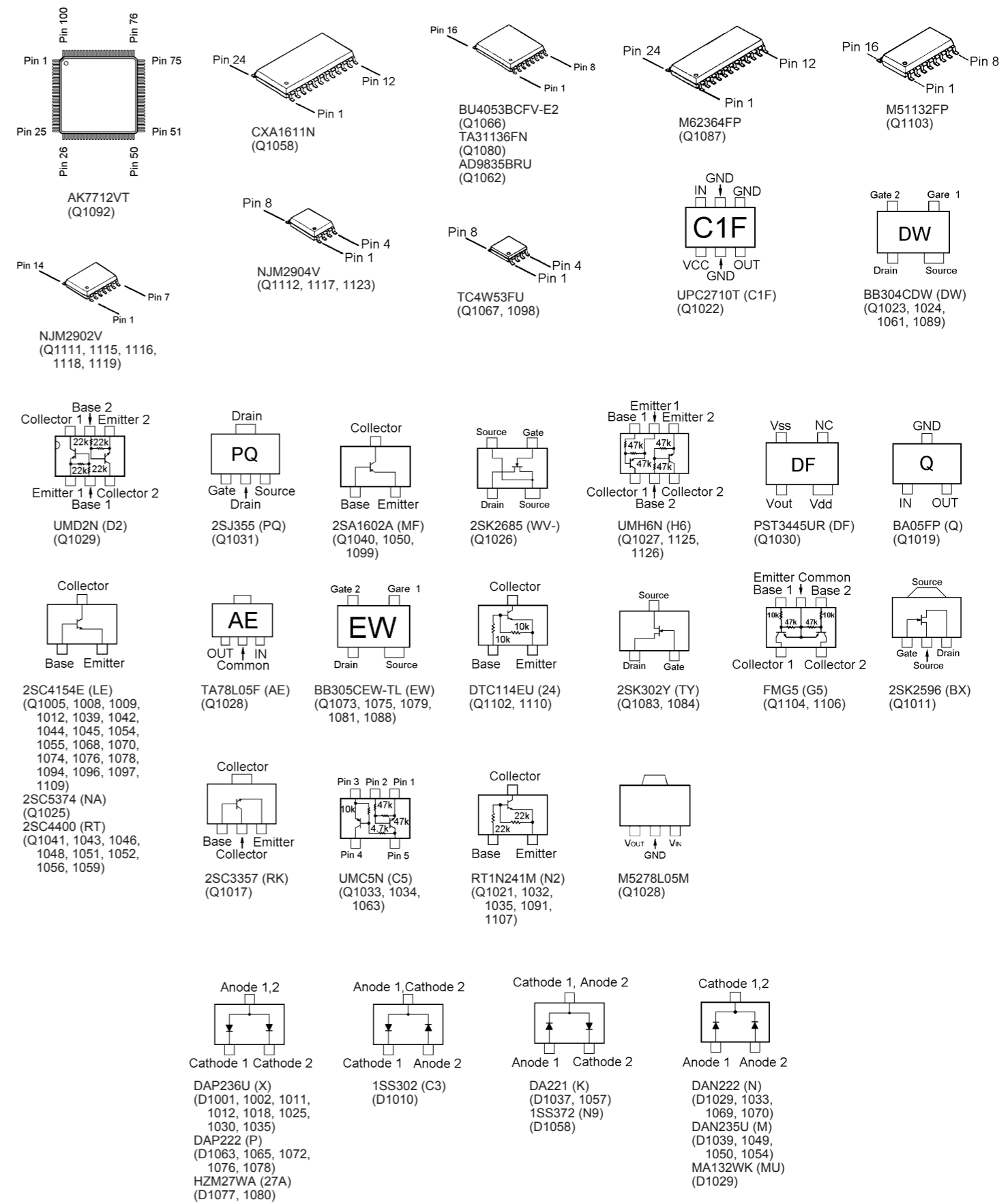

Circuit Diagram

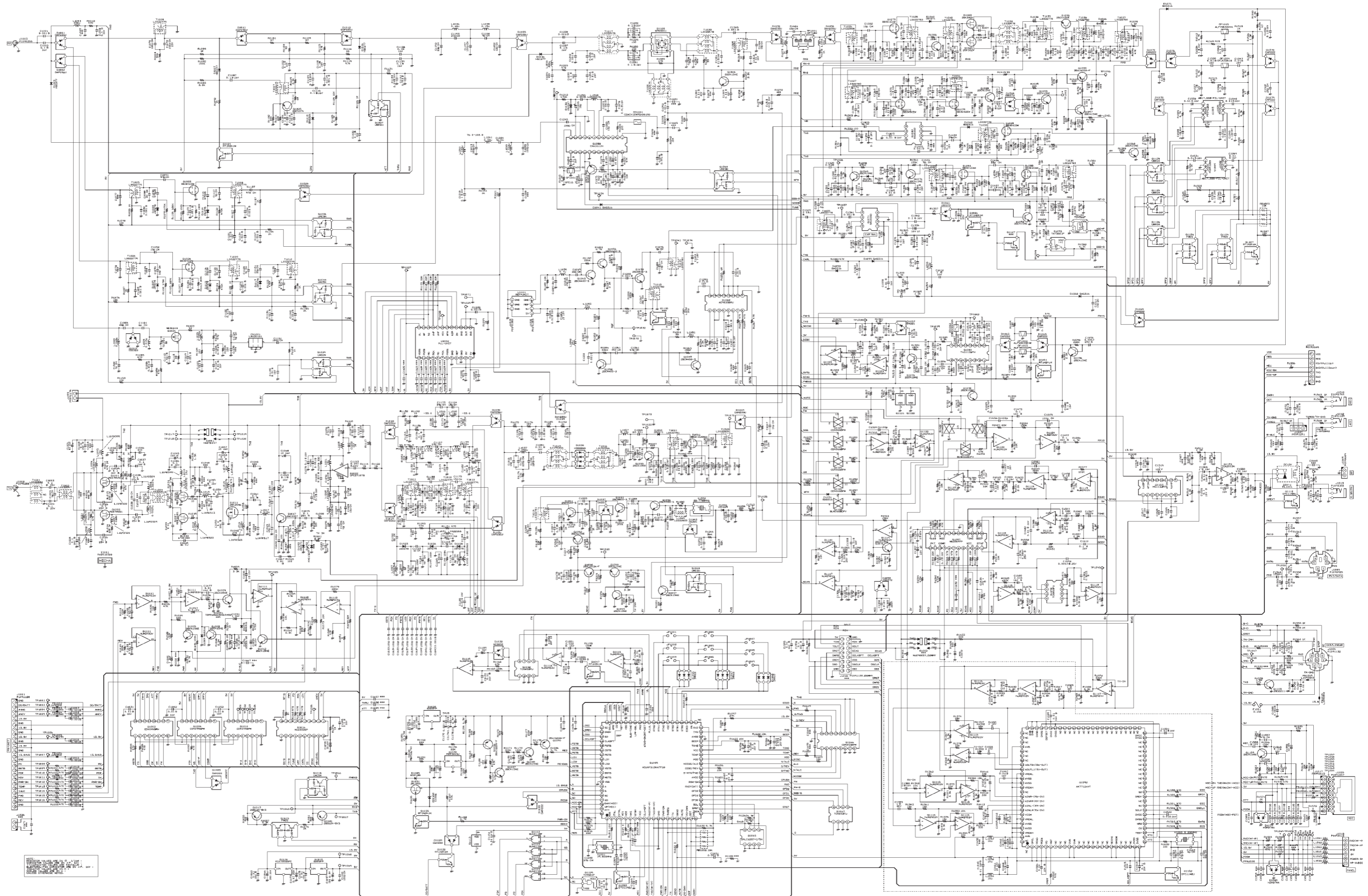

***MAIN Unit (Lot. 50 ~)***

*Note:*

Parts Layout

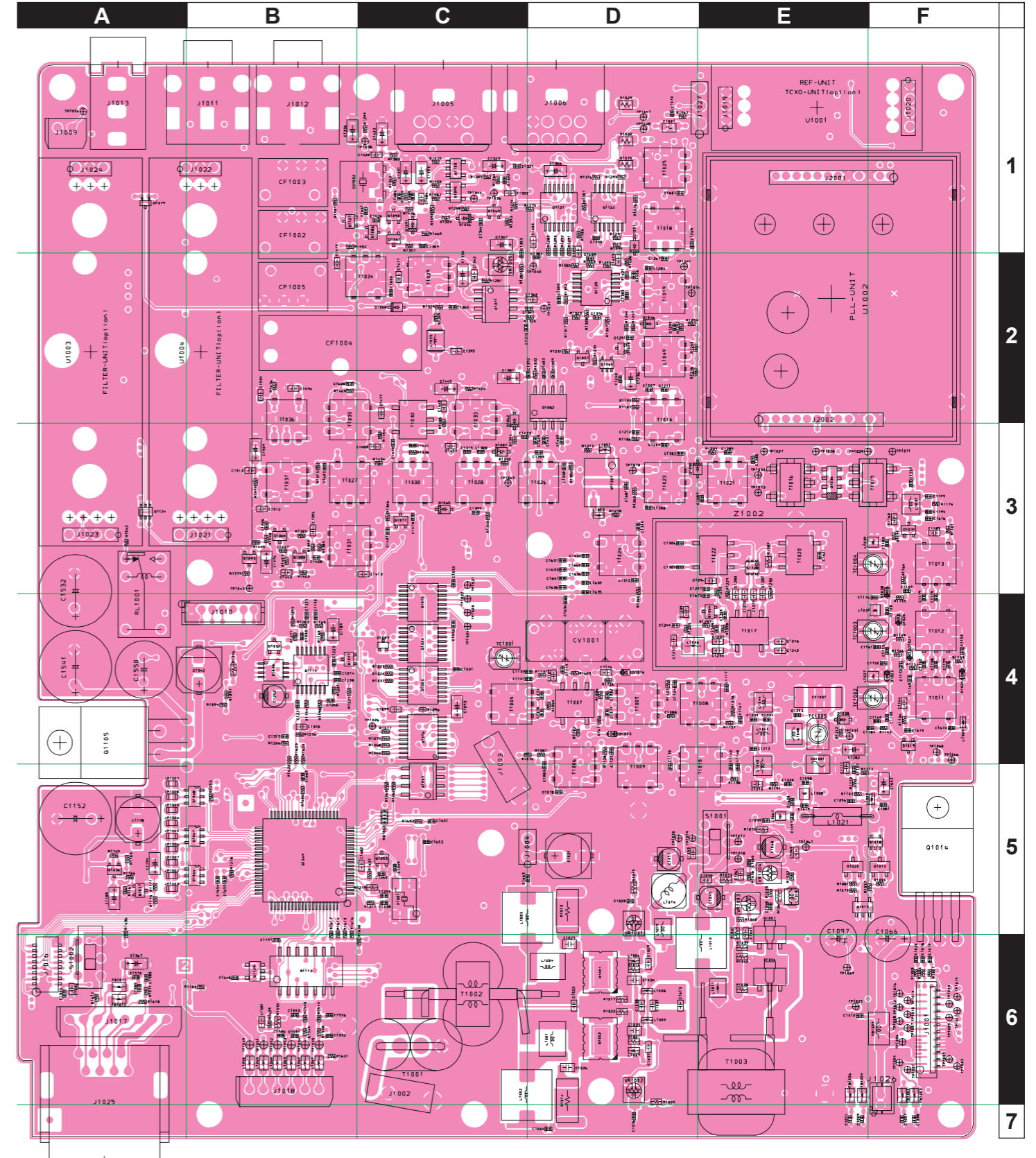
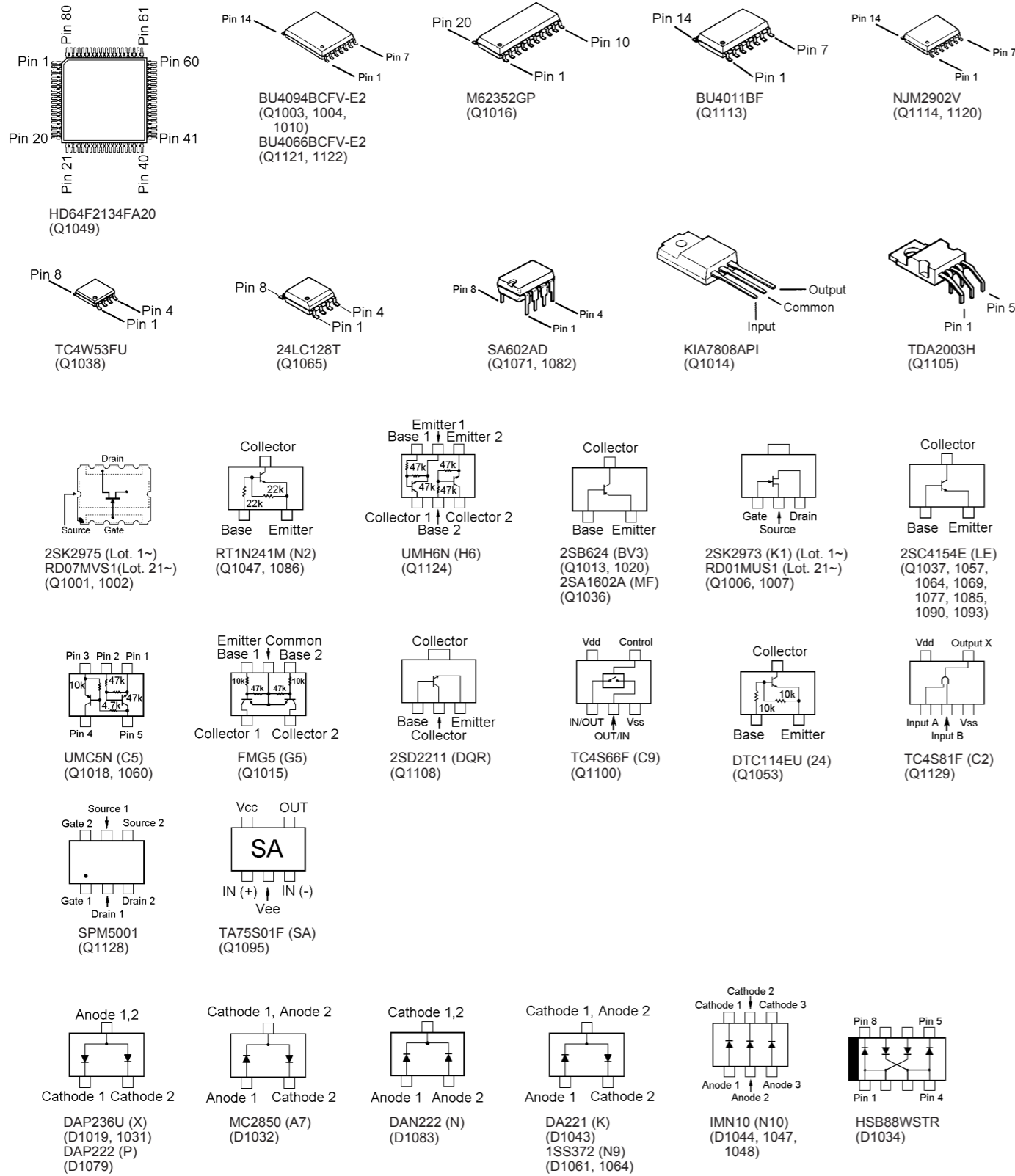

Side A

# MAIN Unit (Lot. 50 ~)

## Parts Layout

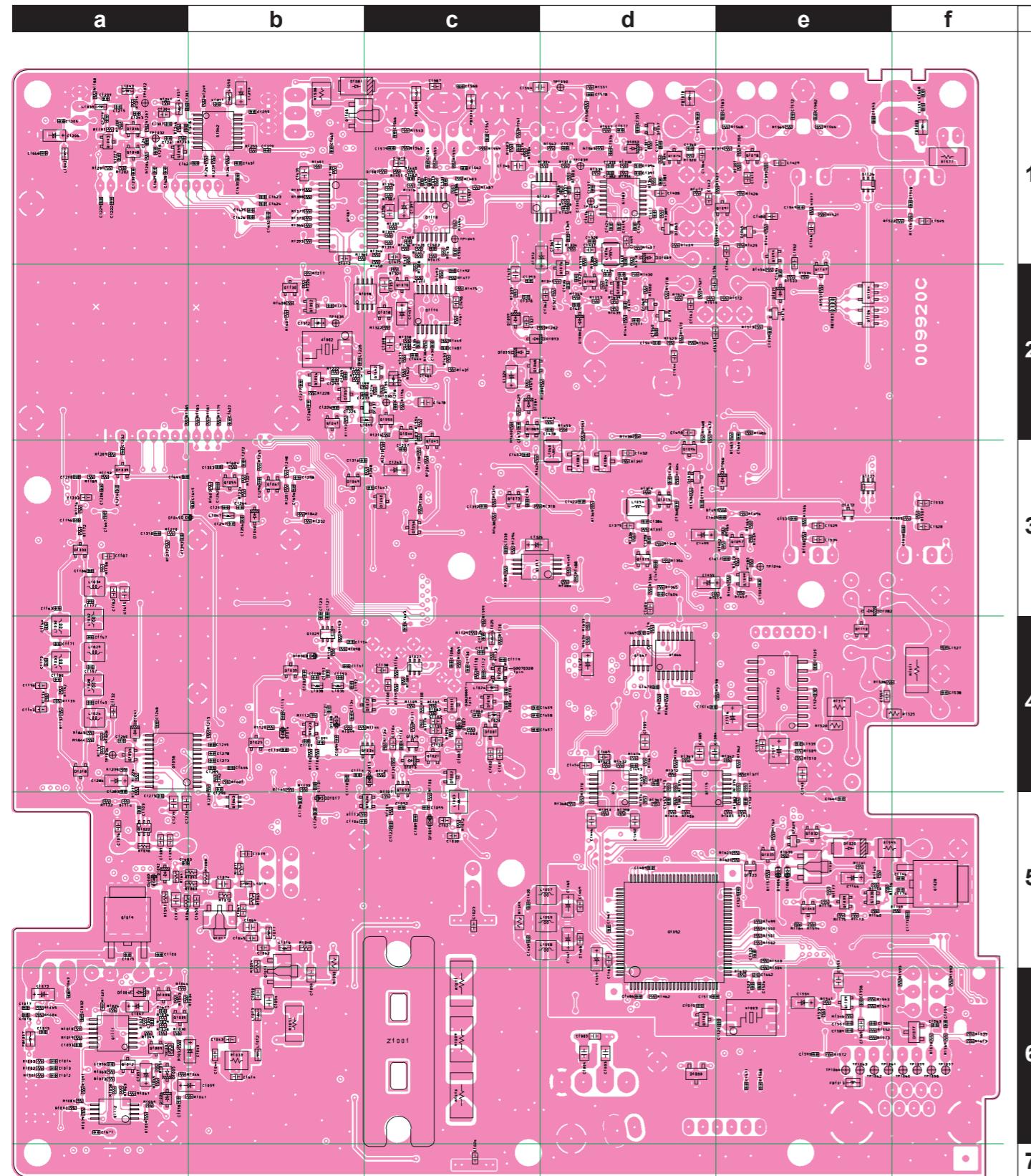

Side B

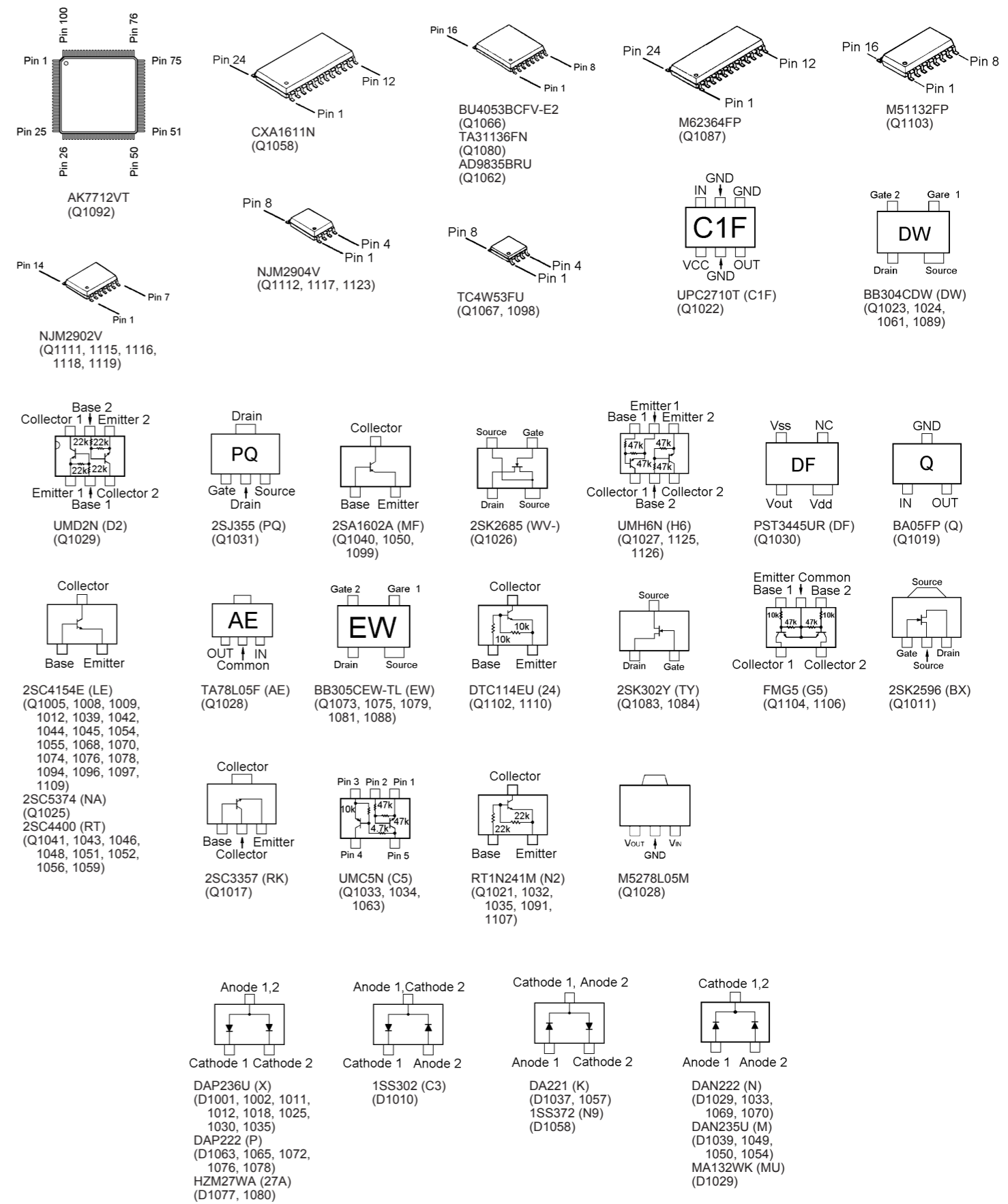

# MAIN Unit

## Parts List

REF	DESCRIPTION	VALUE	V/W	TOL.	MFR'S DESIG	VXSTD P/N	VERS.	LOT	SIDE	LAYADR
	PCB with Components (w/PLL-UNIT, REF-UNIT)				FT-897	CS1827005	USA TYP A2	1-28		
					FT-897	CS1827006	EXP TYP A1	1-28		
					FT-897	CS1827007	EXP TYP A2EX	1-28		
					FT-897	CS1827008	EXP TYP A3	1-28		
					FT-897	CS1827009	EXP TYP B1	1-28		
					FT-897	CS1827010	EXP TYP B2	1-28		
					FT-897	CS1827011	EXP TYP B3	1-28		
					FT-897	CS1827012	EXP TYP C1	1-28		
					FT-897	CS1827013	EXP TYP C2	1-28		
					FT-897	CS1827014	EXP TYP C3	1-28		
					FT-897	CS1827015	EXP TYP D1	1-28		
					FT-897	CS1827016	EXP TYP D2	1-28		
					FT-897	CS1827017	AUS TYP H1	1-28		
					FT-897	CS1827018	AUS TYP H2	1-28		
					FT-897	CS1827019	FRA TYP E1	1-28		
					FT-897	CS1827020	FRA TYP E2	1-28		
					FT-897	CS1827021	FRA TYP E3	1-28		
	PCB with Components (w/PLL-UNIT, TCXO-UNIT)				FT-897D	CP7373005	USA TYP A2	29-50		
					FT-897D	CP7373006	EXP TYP A1	29-50		
					FT-897D	CP7373007	EXP TYP A2EX	29-50		
					FT-897D	CP7373008	EXP TYP A3	29-50		
					FT-897D	CP7373009	EXP TYP B1	29-50		
					FT-897D	CP7373010	EXP TYP B2	29-50		
					FT-897D	CP7373011	EXP TYP B3	29-50		
					FT-897D	CP7373012	EXP TYP C1	29-50		
					FT-897D	CP7373013	EXP TYP C2	29-50		
					FT-897D	CP7373014	EXP TYP C3	29-50		
					FT-897D	CP7373015	EXP TYP D1	29-50		
					FT-897D	CP7373016	EXP TYP D2	29-50		
					FT-897D	CP7373017	AUS TYP H1	29-50		
					FT-897D	CP7373018	AUS TYP H2	29-50		
					FT-897D	CP7373019	FRA TYP E1	29-50		
					FT-897D	CP7373020	EXP TYP E2	29-50		
					FT-897D	CP7373021	FRA TYP E3	29-50		
	PCB with Components (w/PLL-UNIT)				FT-897D	CS1828005	USA TYP A2	51-		
					FT-897D	CS1828006	EXP TYP A1	51-		
					FT-897D	CS1828007	EXP TYP A2EX	51-		
					FT-897D	CS1828008	EXP TYP A3	51-		
					FT-897D	CS1828009	EXP TYP B1	51-		
					FT-897D	CS1828010	EXP TYP B2	51-		
					FT-897D	CS1828011	EXP TYP B3	51-		
					FT-897D	CS1828012	EXP TYP C1	51-		
					FT-897D	CS1828013	EXP TYP C2	51-		
					FT-897D	CS1828014	EXP TYP C3	51-		
					FT-897D	CS1828015	EXP TYP D1	51-		
					FT-897D	CS1828016	EXP TYP D2	51-		
					FT-897D	CS1828017	AUS TYP H1	51-		
					FT-897D	CS1828018	AUS TYP H2	51-		
					FT-897D	CS1828019	FRA TYP E1	51-		
					FT-897D	CS1828020	EXP TYP E2	51-		
					FT-897D	CS1828021	FRA TYP E3	51-		
	Printed Circuit Board					FR007880C		1-3		
						FR007880D		4-24		
						FR009920B		25-49		
						FR009920C		50-		
C 1001	CHIP CAP.	0.001uF	50V	B	GRM188B11H102KA01D	K22174821		1-	B	c4
C 1002	CHIP CAP.	0.1uF	16V	B	GRM188B11C104KA01D	K22124805		1-	B	c4
C 1003	CHIP CAP.	0.1uF	25V	B	GRM21BB11E104KA01L	K22140811		1-	B	d6
C 1004	CHIP CAP.	0.1uF	25V	B	GRM21BB11E104KA01L	K22140811		1-	B	d6
C 1005	CHIP CAP.	6pF	50V	CH	GRM1882C1H6R0DZ01D	K22174207		1-	B	d6
C 1007	CHIP CAP.	0.001uF	50V	B	UMK105B102KW-F	K22178829		1-	A	E7
C 1008	CHIP CAP.	0.001uF	50V	B	UMK105B102KW-F	K22178829		1-	A	F7
C 1009	CHIP CAP.	0.001uF	50V	B	UMK105B102KW-F	K22178829		1-	A	E7
C 1010	CHIP CAP.	0.001uF	50V	B	UMK105B102KW-F	K22178829		1-	A	E6
C 1011	CHIP CAP.	0.001uF	50V	B	UMK105B102KW-F	K22178829		1-	A	E7
C 1012	CHIP CAP.	100pF	50V	CH	UMK105CH101JV-F	K22178282		1-	B	a6
C 1013	CHIP CAP.	220pF	25V	CH	TMK105CH221JV-F	K22148246		1-	B	a6
C 1014	CHIP CAP.	100pF	50V	CH	UMK105CH101JV-F	K22178282		1-	B	a6
C 1015	CHIP CAP.	0.001uF	50V	B	UMK105B102KW-F	K22178829		1-	B	a6
C 1016	CHIP CAP.	0.001uF	50V	B	UMK105B102KW-F	K22178829		1-	B	a6
C 1017	CHIP CAP.	0.001uF	50V	B	UMK105B102KW-F	K22178829		1-	B	a6
C 1018	CHIP CAP.	0.001uF	50V	B	UMK105B102KW-F	K22178829		1-	A	F6
C 1019	CHIP CAP.	0.001uF	50V	B	UMK105B102KW-F	K22178829		1-	A	F6

# MAIN Unit

## Parts List

REF	DESCRIPTION	VALUE	V/W	TOL.	MFR'S DESIG	VXSTD P/N	VERS.	LOT	SIDE	LAYADR
C 1020	CHIP CAP.	0.001uF	50V	B	UMK105B102KW-F	K22178829		1-	A	F6
C 1021	AL.ELECTRO.CAP.	47uF	16V		EEE1CA470SP	K48120005		1-	A	D5
C 1023	CHIP CAP.	0.1uF	16V	B	GRM188B11C104KA01D	K22124805		1-	B	c5
C 1024	CHIP CAP.	0.1uF	16V	B	GRM188B11C104KA01D	K22124805		1-	B	c7
C 1025	CHIP CAP.	0.1uF	16V	B	GRM188B11C104KA01D	K22124805		1-	A	D6
C 1025	CHIP CAP.	0.1uF	25V	B	GRM21BB11E104KA01L	K22140811		25-	A	D6
C 1026	CHIP CAP.	0.1uF	16V	B	GRM188B11C104KA01D	K22124805		1-	A	D6
C 1026	CHIP CAP.	0.1uF	25V	B	GRM21BB11E104KA01L	K22140811		25-	A	D6
C 1029	CHIP CAP.	0.1uF	16V	B	GRM188B11C104KA01D	K22124805		1-	A	D6
C 1030	CHIP CAP.	0.1uF	16V	B	GRM188B11C104KA01D	K22124805		1-	B	c5
C 1031	CHIP CAP.	0.01uF	16V	B	GRM36B103K16PT	K22128804		1-	A	C4
C 1031	CHIP CAP.	0.01uF	25V	B	GRM155B11E103KA01D	K22148834		90-	A	C4
C 1032	CHIP CAP.	0.001uF	50V	B	UMK105B102KW-F	K22178829		1-	B	a6
C 1033	CHIP CAP.	0.001uF	50V	B	UMK105B102KW-F	K22178829		1-	B	a6
C 1034	CHIP CAP.	0.1uF	25V	B	GRM21BB11E104KA01L	K22140811		1-	A	D6
C 1035	CHIP CAP.	0.1uF	25V	B	GRM21BB11E104KA01L	K22140811		1-	A	D6
C 1037	CHIP CAP.	0.1uF	16V	B	GRM188B11C104KA01D	K22124805		1-	A	D6
C 1038	CHIP CAP.	12pF	50V	CH	GRM1882C1H120JA01D	K22174213		1-	A	D6
C 1039	CHIP CAP.	22pF	50V	CH	GRM1882C1H220JA01D	K22174219		1-20	A	D6
C 1039	CHIP CAP.	1pF	50V	CK	GRM1884C1H1R0CZ01D	K22174202		53-	A	D6
C 1040	CHIP TA.CAP.	1uF	16V		TEESVA1C105M8R	K78120009		1-	B	a6
C 1042	CHIP CAP.	0.01uF	16V	B	GRM36B103K16PT	K22128804		1-	A	C4
C 1042	CHIP CAP.	0.01uF	25V	B	GRM155B11E103KA01D	K22148834		90-	A	C4
C 1043	CHIP CAP.	10pF	50V	CH	GRM1882C1H100JA01D	K22174211		1-	B	b6
C 1044	CHIP CAP.	0.01uF	50V	B	GRM188B11H103KA01D	K22174823		1-	B	b6
C 1045	AL.ELECTRO.CAP.	10uF	16V		RV2-16V100MB55U-R	K48120014		1-	A	D5
C 1046	CHIP CAP.	0.1uF	16V	B	GRM188B11C104KA01D	K22124805		1-	A	D5
C 1047	CHIP TA.CAP.	4.7uF	10V		TEESVA1A475M8R	K78100022		1-	B	a6
C 1047	CHIP TA.CAP.	0.22uF	35V		TEESVA1V224M8R	K78160027		86-	B	a6
C 1049	CHIP CAP.	0.1uF	16V	B	GRM188B11C104KA01D	K22124805		1-	A	E6
C 1050	CHIP CAP.	8pF	50V	CH	GRM1882C1H8R0DZ01D	K22174209		1-	B	b6
C 1051	CHIP TA.CAP.	2.2uF	10V		TEESVA1A225M8R	K78100021		1	B	a6
C 1051	CHIP TA.CAP.	1uF	16V		TEESVA1C105M8R	K78120009		2-	B	a6
C 1052	CHIP CAP.	0.01uF	16V	B	GRM36B103K16PT	K22128804		1-	A	C3
C 1052	CHIP CAP.	0.01uF	25V	B	GRM155B11E103KA01D	K22148834		90-	A	C3
C 1053	CHIP CAP.	0.1uF	16V	B	GRM188B11C104KA01D	K22124805		1-	A	D5
C 1054	CHIP CAP.	0.1uF	25V	B	GRM21BB11E104KA01L	K22140811		1-	B	b6
C 1055	CHIP CAP.	0.1uF	25V	B	GRM21BB11E104KA01L	K22140811		1-	B	b6
C 1056	CHIP CAP.	0.1uF	10V	B	GRM155B11A104KA01D	K22108802		1-	B	a6
C 1057	AL.ELECTRO.CAP.	10uF	16V		RV2-16V100MB55U-R	K48120014		1-	A	D5
C 1058	CHIP CAP.	0.01uF	16V	B	GRM36B103K16PT	K22128804		1-	B	a6
C 1058	CHIP CAP.	0.01uF	25V	B	GRM155B11E103KA01D	K22148834		90-	B	a6
C 1059	CHIP TA.CAP.	10uF	10V		TEESVA1A106M8R	K78100028		1-	B	a6
C 1061	CHIP CAP.	0.1uF	16V	B	GRM188B11C104KA01D	K22124805		1-	A	E5
C 1063	CHIP CAP.	0.01uF	16V	B	GRM36B103K16PT	K22128804		1-	B	a6
C 1063	CHIP CAP.	0.01uF	25V	B	GRM155B11E103KA01D	K22148834		90-	B	a6
C 1064	CHIP CAP.	0.1uF	25V	B	GRM21BB11E104KA01L	K22140811		1-	B	b5
C 1065	CHIP CAP.	10pF	50V	CH	GRM1882C1H100JA01D	K22174211		1-	B	b5
C 1066	AL.ELECTRO.CAP.	100uF	16V		RC2-16V101MF1#	K40129038		1-	A	E6
C 1067	CHIP CAP.	0.01uF	50V	B	GRM188B11H103KA01D	K22174823		1-	B	b5
C 1068	AL.ELECTRO.CAP.	10uF	16V		RV2-16V100MB55U-R	K48120014		1-	A	E5
C 1069	CHIP CAP.	0.1uF	16V	B	GRM188B11C104KA01D	K22124805		1-	A	E5
C 1070	CHIP CAP.	120pF	50V	CH	UMK105CH121JV-F	K22178284		1-	A	C4
C 1071	CHIP CAP.	0.1uF	25V	B	GRM21BB11E104KA01L	K22140811		1-	B	a5
C 1072	CHIP CAP.	150pF	50V	CH	GRM1552C1H151JA01D	K22178240		1-	A	C4
C 1072	CHIP CAP.	150pF	25V	CH	TMK105CH151JV-F	K22148242		4-	A	C4
C 1073	CHIP TA.CAP.	0.47uF	25V		TEESVA1E474M8R	K78140009		1-	B	a6
C 1074	CHIP CAP.	0.1uF	25V	B	GRM21BB11E104KA01L	K22140811		1-	B	b5
C 1075	CHIP CAP.	0.01uF	16V	B	GRM36B103K16PT	K22128804		1-	B	a5
C 1075	CHIP CAP.	0.01uF	25V	B	GRM155B11E103KA01D	K22148834		90-	B	a5
C 1076	CHIP CAP.	0.1uF	16V	B	GRM188B11C104KA01D	K22124805		1-	B	a5
C 1079	CHIP CAP.	0.1uF	16V	B	GRM188B11C104KA01D	K22124805		1-	B	b5
C 1080	CERAMIC CAP.	7pF	50V	CH	RBU04CH070C-L05AC	K02179083		1-	B	c4
C 1080	CERAMIC CAP.	7pF	50V	SL	RBU04SL070C-L05AC	K00179070		3	B	c4
C 1080	CHIP CAP.	7pF	50V	CH	UMK105CH070DV-F	K22178255		4-	B	c4
C 1081	CHIP CAP.	0.001uF	50V	B	UMK105B102KW-F	K22178829		1-	A	E5
C 1082	CHIP CAP.	0.001uF	50V	B	UMK105B102KW-F	K22178829		1-	A	D4
C 1083	CHIP CAP.	0.001uF	50V	B	UMK105B102KW-F	K22178829		1-	A	C5
C 1084	CHIP CAP.	22pF	50V	CH	UMK105CH220JV-F	K22178266		1-	B	c4
C 1085	CHIP CAP.	0.001uF	50V	B	GRM188B11H102KA01D	K22174821		1-	B	a5
C 1086	CHIP CAP.	0.001uF	50V	B	UMK105B102KW-F	K22178829		1-	B	c4
C 1087	CHIP CAP.	0.1uF	16V	B	GRM188B11C104KA01D	K22124805		1-	B	c4
C 1088	CHIP CAP.	2pF	50V	CK	UMK105CK020CV-F	K22178250		1-	A	D4



# MAIN Unit

## Parts List

REF	DESCRIPTION	VALUE	V/W	TOL.	MFR'S DESIG	VXSTD P/N	VERS.	LOT	SIDE	LAYADR
C 1090	CHIP CAP.	0.1uF	16V	B	GRM188B11C104KA01D	K22124805		1-	B	a5
C 1090	CHIP CAP.	0.001uF	50V	B	GRM188B11H102KA01D	K22174821		86-	B	a5
C 1091	CHIP CAP.	47pF	50V	CH	UMK105CH470JV-F	K22178274		1-	B	b4
C 1092	CHIP CAP.	15pF	50V	CH	UMK105CH150JV-F	K22178262		1-	B	c5
C 1093	CHIP TA.CAP.	10uF	10V		TEESVA1A106M8R	K78100028		1-	A	C4
C 1094	CHIP CAP.	470pF	50V	B	UMK105B471KW-F	K22178825		1-	B	b4
C 1095	CHIP CAP.	33pF	50V	CH	UMK105CH330JV-F	K22178270		1-	B	c5
C 1096	CHIP CAP.	0.01uF	16V	B	GRM36B103K16PT	K22128804		1-	A	E5
C 1096	CHIP CAP.	0.01uF	25V	B	GRM155B11E103KA01D	K22148834		90-	A	E5
C 1097	AL.ELECTRO.CAP.	100uF	6.3V		RC2-6V101ME1#-T58	K46080006		1-	A	E6
C 1099	CHIP CAP.	0.1uF	16V	B	GRM188B11C104KA01D	K22124805		1-	A	C4
C 1100	CHIP CAP.	100pF	50V	CH	UMK105CH101JV-F	K22178282		1-	B	a5
C 1101	CHIP CAP.	6pF	50V	CH	UMK105CH060DV-F	K22178254		1-	B	c4
C 1101	CHIP CAP.	7pF	50V	CH	UMK105CH070DV-F	K22178255		67-	B	c4
C 1102	CHIP CAP.	0.1uF	16V	B	GRM188B11C104KA01D	K22124805		1-	B	c4
C 1103	CHIP CAP.	0.047uF	10V	BJ	LMK105BJ473KV-F	K22128805		1-	B	a5
C 1103	CHIP CAP.	0.01uF	25V	B	GRM155B11E103KA01D	K22148834		86-	B	a5
C 1104	CHIP CAP.	0.1uF	16V	B	GRM188B11C104KA01D	K22124805		1-	B	c4
C 1105	CHIP CAP.	0.001uF	50V	B	UMK105B102KW-F	K22178829		1-	B	b4
C 1106	CHIP CAP.	0.001uF	50V	B	UMK105B102KW-F	K22178829		1-	B	b5
C 1107	CHIP CAP.	0.001uF	50V	B	UMK105B102KW-F	K22178829		1-	A	E5
C 1108	CHIP CAP.	0.1uF	16V	B	GRM188B11C104KA01D	K22124805		1-	B	c4
C 1109	CHIP CAP.	0.1uF	16V	B	GRM188B11C104KA01D	K22124805		1-	A	C4
C 1110	CHIP CAP.	0.001uF	50V	B	UMK105B102KW-F	K22178829		1-	B	c4
C 1111	CHIP CAP.	0.1uF	16V	B	GRM188B11C104KA01D	K22124805		1-	A	E5
C 1112	CHIP CAP.	0.001uF	50V	B	UMK105B102KW-F	K22178829		1-	B	c4
C 1113	CHIP CAP.	470pF	50V	B	UMK105B471KW-F	K22178825		1-	B	b4
C 1114	CHIP CAP.	33pF	50V	CH	UMK105CH330JV-F	K22178270		1-	B	b4
C 1115	CHIP CAP.	0.001uF	50V	B	UMK105B102KW-F	K22178829		1-	A	D4
C 1116	CHIP CAP.	0.1uF	16V	B	GRM188B11C104KA01D	K22124805		1-	A	D4
C 1117	CHIP CAP.	5pF	50V	CH	UMK105CH050CV-F	K22178253		1-	A	D4
C 1118	CHIP CAP.	2pF	50V	CK	GRM1554C1H2R0CZ01D	K22178204		1-	B	b4
C 1118	CHIP CAP.	2pF	50V	CK	UMK105CK020CV-F	K22178250		4-	B	b4
C 1119	CHIP CAP.	0.001uF	50V	B	UMK105B102KW-F	K22178829		1-	B	c4
C 1120	CHIP CAP.	0.1uF	16V	B	GRM188B11C104KA01D	K22124805		1-	B	c4
C 1121	CHIP CAP.	0.01uF	16V	B	GRM36B103K16PT	K22128804		1-	B	b4
C 1121	CHIP CAP.	0.01uF	25V	B	GRM155B11E103KA01D	K22148834		90-	B	b4
C 1122	CHIP CAP.	0.01uF	16V	B	GRM36B103K16PT	K22128804		1-	B	c5
C 1122	CHIP CAP.	0.01uF	25V	B	GRM155B11E103KA01D	K22148834		90-	B	c5
C 1123	CHIP CAP.	0.001uF	50V	B	UMK105B102KW-F	K22178829		1-	B	b4
C 1124	CHIP CAP.	0.001uF	50V	B	UMK105B102KW-F	K22178829		1-	A	D4
C 1125	CHIP CAP.	0.001uF	50V	B	UMK105B102KW-F	K22178829		1-	A	D4
C 1126	CHIP CAP.	0.001uF	50V	B	UMK105B102KW-F	K22178829		1-	B	c4
C 1127	CHIP CAP.	0.01uF	16V	B	GRM36B103K16PT	K22128804		1-	B	b4
C 1127	CHIP CAP.	0.01uF	25V	B	GRM155B11E103KA01D	K22148834		90-	B	b4
C 1128	CHIP CAP.	7pF	50V	CH	UMK105CH070DV-F	K22178255		1-	B	b5
C 1129	CHIP CAP.	4pF	50V	CH	UMK105CH040CV-F	K22178252		1-	B	c4
C 1131	CHIP CAP.	33pF	50V	CH	UMK105CH330JV-F	K22178270		1-	B	b5
C 1132	CHIP CAP.	0.1uF	16V	B	GRM188B11C104KA01D	K22124805		1-	B	a4
C 1133	CHIP CAP.	0.01uF	16V	B	GRM36B103K16PT	K22128804		1-	A	C4
C 1133	CHIP CAP.	0.01uF	25V	B	GRM155B11E103KA01D	K22148834		90-	A	C4
C 1134	CHIP CAP.	0.001uF	50V	B	UMK105B102KW-F	K22178829		1-	B	b4
C 1136	CHIP CAP.	0.001uF	50V	B	UMK105B102KW-F	K22178829		1-	B	b5
C 1137	CHIP CAP.	47pF	50V	CH	UMK105CH470JV-F	K22178274		1-	B	b4
C 1138	CHIP CAP.	0.1uF	16V	B	GRM188B11C104KA01D	K22124805		1-	B	b4
C 1139	CHIP CAP.	0.1uF	16V	B	GRM188B11C104KA01D	K22124805		1-	B	c4
C 1140	CHIP CAP.	2pF	50V	CK	UMK105CK020CV-F	K22178250		1-	A	E4
C 1141	CHIP CAP.	0.001uF	50V	B	UMK105B102KW-F	K22178829		1-	A	C4
C 1142	CHIP CAP.	0.001uF	50V	B	UMK105B102KW-F	K22178829		1-	A	D5
C 1143	CHIP CAP.	0.1uF	16V	B	GRM188B11C104KA01D	K22124805		1-	B	a4
C 1144	CHIP CAP.	0.1uF	16V	B	GRM188B11C104KA01D	K22124805		1-	A	F4
C 1145	CHIP CAP.	100pF	50V	CH	UMK105CH101JV-F	K22178282		1-	B	a4
C 1146	CHIP CAP.	0.01uF	16V	B	GRM36B103K16PT	K22128804		1-	B	e5
C 1146	CHIP CAP.	0.01uF	25V	B	GRM155B11E103KA01D	K22148834		90-	B	e5
C 1147	CHIP CAP.	0.001uF	50V	B	UMK105B102KW-F	K22178829		1-	A	E4
C 1148	CHIP CAP.	0.001uF	50V	B	UMK105B102KW-F	K22178829		1-	A	E5
C 1150	CHIP CAP.	6pF	50V	CH	UMK105CH060DV-F	K22178254		1-	A	E4
C 1151	CHIP CAP.	100pF	50V	CH	UMK105CH101JV-F	K22178282		1-	B	b4
C 1152	AL.ELECTRO.CAP.	1000uF	16V		RE3-16V102MH3#	K40129096		1-	A	A5
C 1153	CHIP CAP.	1pF	50V	CK	UMK105CK010CV-F	K22178248		1-	A	E4
C 1154	CHIP CAP.	0.01uF	16V	B	GRM36B103K16PT	K22128804		1-	B	b4
C 1154	CHIP CAP.	0.01uF	25V	B	GRM155B11E103KA01D	K22148834		90-	B	b4
C 1155	CHIP CAP.	33pF	50V	CH	UMK105CH330JV-F	K22178270		1-	A	F4

# MAIN Unit

## Parts List

REF	DESCRIPTION	VALUE	V/W	TOL.	MFR'S DESIG	VXSTD P/N	VERS.	LOT	SIDE	LAYADR
C 1156	CHIP CAP.	0.1uF	16V	B	GRM188B11C104KA01D	K22124805		1-	B	a4
C 1157	CHIP CAP.	27pF	50V	CH	UMK105CH270JV-F	K22178268		1-	B	a4
C 1158	CHIP CAP.	2pF	50V	CK	UMK105CK020CV-F	K22178250		1-	A	F4
C 1159	CHIP CAP.	3pF	50V	CJ	UMK105CJ030CV-F	K22178251		1-	A	F4
C 1159	CHIP CAP.	1pF	50V	CK	UMK105CK010CV-F	K22178248		25-	A	F4
C 1160	CHIP CAP.	0.1uF	16V	B	GRM188B11C104KA01D	K22124805		1-	A	E3
C 1161	CHIP CAP.	5pF	50V	CH	UMK105CH050CV-F	K22178253		1-	A	E4
C 1161	CHIP CAP.	6pF	50V	CH	UMK105CH060DV-F	K22178254		37-	A	E4
C 1162	CHIP CAP.	3pF	50V	CJ	UMK105CJ030CV-F	K22178251		1-	A	F4
C 1163	CHIP CAP.	100pF	50V	CH	UMK105CH101JV-F	K22178282		1-	B	a4
C 1163	CHIP CAP.	180pF	25V	CH	TMK105CH181JV-F	K22148244		17-	B	a4
C 1163	CHIP CAP.	100pF	50V	CH	UMK105CH101JV-F	K22178282		86-	B	a4
C 1164	CHIP CAP.	9pF	50V	CH	UMK105CH090DV-F	K22178257		1-	B	a4
C 1164	CHIP CAP.	15pF	50V	CH	UMK105CH150JV-F	K22178262		17-	B	a4
C 1164	CHIP CAP.	7pF	50V	CH	UMK105CH070DV-F	K22178255		86-	B	a4
C 1165	CHIP CAP.	33pF	50V	CH	UMK105CH330JV-F	K22178270		1-	A	F4
C 1166	CHIP TA.CAP.	1uF	16V		TEESVA1C105M8R	K78120009		1-	B	e5
C 1167	CHIP CAP.	220pF	25V	CH	TMK105CH221JV-F	K22148246		1-	B	a4
C 1168	CHIP CAP.	0.5pF	50V	CK	GRM1554C1HR50BZ01D	K22178285		1-	A	E4
C 1168	CHIP CAP.	0.5pF	50V	CK	UMK105CK0R5CV-F	K22178247		17-	A	E4
C 1169	CHIP CAP.	0.001uF	50V	B	UMK105B102KW-F	K22178829		1-	A	F4
C 1170	CHIP CAP.	0.001uF	50V	B	UMK105B102KW-F	K22178829		1-	B	e5
C 1171	CHIP CAP.	150pF	50V	CH	GRM1552C1H151JA01D	K22178240		1-	B	a4
C 1171	CHIP CAP.	150pF	25V	CH	TMK105CH151JV-F	K22148242		4-	B	a4
C 1171	CHIP CAP.	270pF	25V	CH	GRM36CH271J25PT	K22148248		17-	B	a4
C 1171	CHIP CAP.	270pF	50V	B	UMK105B271KW-F	K22178822		25-	B	a4
C 1171	CHIP CAP.	220pF	25V	CH	TMK105CH221JV-F	K22148246		86-	B	a4
C 1172	CHIP CAP.	0.001uF	50V	B	UMK105B102KW-F	K22178829		1-	A	E4
C 1173	CHIP CAP.	27pF	50V	CH	UMK105CH270JV-F	K22178268		1-	B	a4
C 1173	CHIP CAP.	39pF	50V	CH	UMK105CH390JV-F	K22178272		17-	B	a4
C 1173	CHIP CAP.	15pF	50V	CH	UMK105CH150JV-F	K22178262		86-	B	a4
C 1174	CHIP CAP.	0.01uF	16V	B	GRM36B103K16PT	K22128804		1-	B	e5
C 1174	CHIP CAP.	0.01uF	25V	B	GRM155B11E103KA01D	K22148834		90-	B	e5
C 1175	CHIP CAP.	10pF	50V	CH	UMK105CH100DV-F	K22178258		1-	A	F4
C 1176	CHIP CAP.	4pF	50V	CH	UMK105CH040CV-F	K22178252		1-	A	E4
C 1176	CHIP CAP.	6pF	50V	CH	UMK105CH060DV-F	K22178254		37-	A	E4
C 1177	CHIP CAP.	27pF	50V	CH	UMK105CH270JV-F	K22178268		1-	B	a3
C 1178	AL.ELECTRO.CAP.	100uF	6.3V		RV2-6V101MU-R	K48080005		1-	A	A5
C 1179	CHIP CAP.	10pF	50V	CH	UMK105CH100DV-F	K22178258		1-	A	F4
C 1180	CHIP CAP.	68pF	50V	CH	UMK105CH680JV-F	K22178278		1-	B	a4
C 1180	CHIP CAP.	120pF	50V	CH	UMK105CH121JV-F	K22178284		17-	B	a4
C 1182	CHIP CAP.	0.1uF	16V	B	GRM188B11C104KA01D	K22124805		1-	B	a3
C 1183	CHIP CAP.	2pF	50V	CK	UMK105CK020CV-F	K22178250		1-	A	E3
C 1184	CHIP CAP.	0.001uF	50V	B	UMK105B102KW-F	K22178829		1-	A	E4
C 1184	CHIP CAP.	0.01uF	16V	B	GRM36B103K16PT	K22128804		14-	A	E4
C 1184	CHIP CAP.	0.01uF	25V	B	GRM155B11E103KA01D	K22148834		90-	A	E4
C 1185	CHIP CAP.	0.1uF	16V	B	GRM188B11C104KA01D	K22124805		1-	A	F3
C 1186	CHIP CAP.	120pF	50V	CH	UMK105CH121JV-F	K22178284		1-	B	a3
C 1187	CHIP CAP.	0.1uF	16V	B	GRM188B11C104KA01D	K22124805		1-	B	a3
C 1188	CHIP TA.CAP.	1uF	16V		TEESVA1C105M8R	K78120009		1-	A	A5
C 1189	CHIP TA.CAP.	1uF	16V		TEESVA1C105M8R	K78120009		1-	A	B4
C 1190	CHIP CAP.	0.01uF	16V	B	GRM36B103K16PT	K22128804		1-	A	B4
C 1190	CHIP CAP.	0.01uF	25V	B	GRM155B11E103KA01D	K22148834		90-	A	B4
C 1191	CHIP CAP.	0.01uF	16V	B	GRM36B103K16PT	K22128804		1-	A	B6
C 1191	CHIP CAP.	0.01uF	25V	B	GRM155B11E103KA01D	K22148834		90-	A	B6
C 1192	CHIP CAP.	33pF	50V	CH	UMK105CH330JV-F	K22178270		1-	B	b4
C 1193	CHIP CAP.	27pF	50V	CH	UMK105CH270JV-F	K22178268		1-	B	b4
C 1194	CHIP TA.CAP.	1uF	16V		TEESVA1C105M8R	K78120009		1-	A	A5
C 1195	CHIP CAP.	120pF	50V	CH	UMK105CH121JV-F	K22178284		1-	A	F3
C 1196	CHIP CAP.	0.001uF	50V	B	UMK105B102KW-F	K22178829		1-	B	a3
C 1197	CHIP CAP.	100pF	50V	CH	UMK105CH101JV-F	K22178282		1-	B	b4
C 1198	CHIP CAP.	9pF	50V	CH	UMK105CH090DV-F	K22178257		1-	B	b4
C 1199	CHIP CAP.	120pF	50V	CH	UMK105CH121JV-F	K22178284		1-	A	F3
C 1200	CHIP CAP.	0.001uF	50V	B	UMK105B102KW-F	K22178829		1-	B	a3
C 1201	CHIP CAP.	0.01uF	16V	B	GRM36B103K16PT	K22128804		1-	A	F3
C 1201	CHIP CAP.	0.0022uF	50V	B	UMK105B222KW-F	K22178833		86-	A	F3
C 1202	CHIP CAP.	68pF	50V	CH	UMK105CH680JV-F	K22178278		1-	B	b4
C 1203	CHIP CAP.	0.1uF	16V	B	GRM188B11C104KA01D	K22124805		1-	B	a3
C 1204	CHIP CAP.	12pF	50V	CH	GRM1552C1H120JZ01D	K22178214		1-	A	D3
C 1204	CHIP CAP.	12pF	50V	CH	UMK105CH120JV-F	K22178260		4-	A	D3
C 1204	CHIP CAP.	5pF	50V	CH	UMK105CH050CV-F	K22178253		86-	A	D3
C 1205	CHIP CAP.	0.01uF	16V	B	GRM36B103K16PT	K22128804		1-	B	a1
C 1205	CHIP CAP.	0.01uF	25V	B	GRM155B11E103KA01D	K22148834		90-	B	a1

# MAIN Unit

## Parts List

REF	DESCRIPTION	VALUE	V/W	TOL.	MFR'S DESIG	VXSTD P/N	VERS.	LOT	SIDE	LAYADR
C 1206	CHIP TA.CAP.	10uF	10V		TEESVA1A106M8R	K78100028		1-	B	a1
C 1207	CHIP CAP.	0.01uF	16V	B	GRM36B103K16PT	K22128804		1-	A	D2
C 1207	CHIP CAP.	0.01uF	25V	B	GRM155B11E103KA01D	K22148834		90-	A	D2
C 1208	CHIP CAP.	0.001uF	50V	B	UMK105B102KW-F	K22178829		1-	B	a3
C 1209	CHIP CAP.	18pF	50V	CH	UMK105CH180JV-F	K22178264		1-	B	a1
C 1210	CHIP CAP.	0.1uF	16V	B	GRM188B11C104KA01D	K22124805		1-	A	E5
C 1211	CHIP CAP.	18pF	50V	CH	UMK105CH180JV-F	K22178264		1-	A	D2
C 1212	CHIP CAP.	0.01uF	16V	B	GRM36B103K16PT	K22128804		1-	A	D3
C 1212	CHIP CAP.	0.01uF	25V	B	GRM155B11E103KA01D	K22148834		90-	A	D3
C 1213	CHIP CAP.	100pF	50V	CH	UMK105CH101JV-F	K22178282		1-	A	E4
C 1214	CHIP CAP.	0.001uF	50V	B	UMK105B102KW-F	K22178829		1-	A	B4
C 1215	CHIP CAP.	15pF	50V	CH	UMK105CH150JV-F	K22178262		1-	B	a1
C 1216	CHIP CAP.	0.001uF	50V	B	UMK105B102KW-F	K22178829		1-	B	a3
C 1217	CHIP TA.CAP.	1uF	10V		TEESVP1A105M8R	K78100032		1-	B	c2
C 1218	CHIP CAP.	0.01uF	16V	B	GRM36B103K16PT	K22128804		1-	B	c2
C 1218	CHIP CAP.	0.01uF	25V	B	GRM155B11E103KA01D	K22148834		90-	B	c2
C 1219	CHIP CAP.	22pF	50V	CH	UMK105CH220JV-F	K22178266		1-	B	a1
C 1221	CHIP CAP.	0.022uF	16V	B	EMK105B223KW-F	K22128813		1-	A	B4
C 1222	CHIP CAP.	0.001uF	50V	B	UMK105B102KW-F	K22178829		1-	B	a1
C 1223	CHIP CAP.	0.0033uF	50V	B	UMK105B332KW-F	K22178835		1-	A	B4
C 1224	CHIP CAP.	9pF	50V	CH	UMK105CH090DV-F	K22178257		1-	A	E4
C 1225	CHIP CAP.	27pF	50V	CH	UMK105CH270JV-F	K22178268		1-	B	b2
C 1226	CHIP CAP.	100pF	50V	CH	UMK105CH101JV-F	K22178282		1-	B	b2
C 1227	CHIP CAP.	0.01uF	16V	B	GRM36B103K16PT	K22128804		1-	B	a1
C 1227	CHIP CAP.	0.01uF	25V	B	GRM155B11E103KA01D	K22148834		90-	B	a1
C 1228	CHIP CAP.	0.01uF	16V	B	GRM36B103K16PT	K22128804		1-	B	b2
C 1228	CHIP CAP.	0.01uF	25V	B	GRM155B11E103KA01D	K22148834		90-	B	b2
C 1229	CHIP CAP.	0.001uF	50V	B	UMK105B102KW-F	K22178829		1-	B	a1
C 1230	CHIP CAP.	0.001uF	50V	B	UMK105B102KW-F	K22178829		1-	B	a1
C 1232	CHIP CAP.	0.001uF	50V	B	UMK105B102KW-F	K22178829		1-	B	a3
C 1234	CHIP CAP.	0.001uF	50V	B	GRM188B11H102KA01D	K22174821		1-	A	D4
C 1235	CHIP CAP.	100pF	50V	CH	UMK105CH101JV-F	K22178282		1-	A	E4
C 1236	CHIP TA.CAP.	10uF	10V		TEESVA1A106M8R	K78100028		1-	A	D2
C 1237	CHIP CAP.	0.1uF	16V	B	GRM188B11C104KA01D	K22124805		1-	A	D4
C 1238	CHIP CAP.	27pF	50V	CH	UMK105CH270JV-F	K22178268		1-	A	B5
C 1238	CHIP CAP.	10pF	50V	CH	UMK105CH100DV-F	K22178258		61-	A	B5
C 1239	CHIP CAP.	0.1uF	16V	B	GRM188B11C104KA01D	K22124805		1-	A	D4
C 1240	CHIP CAP.	0.01uF	16V	B	GRM36B103K16PT	K22128804		1-	A	D2
C 1240	CHIP CAP.	0.01uF	25V	B	GRM155B11E103KA01D	K22148834		90-	A	D2
C 1241	CHIP CAP.	10pF	50V	CH	UMK105CH100DV-F	K22178258		1-	B	a1
C 1242	CHIP CAP.	0.001uF	50V	B	GRM188B11H102KA01D	K22174821		1-	A	E4
C 1243	CHIP CAP.	0.01uF	16V	B	GRM36B103K16PT	K22128804		1-	B	a1
C 1243	CHIP CAP.	0.01uF	25V	B	GRM155B11E103KA01D	K22148834		90-	B	a1
C 1244	CHIP CAP.	0.01uF	16V	B	GRM36B103K16PT	K22128804		1-	A	D4
C 1244	CHIP CAP.	0.01uF	25V	B	GRM155B11E103KA01D	K22148834		90-	A	D4
C 1245	CHIP CAP.	100pF	50V	CH	UMK105CH101JV-F	K22178282		1-	B	b4
C 1246	CHIP CAP.	0.1uF	16V	B	GRM188B11C104KA01D	K22124805		1-	A	E4
C 1247	CHIP CAP.	4pF	50V	CH	GRM1552C1H4R0CZ01D	K22178206		1-	B	b3
C 1247	CHIP CAP.	4pF	50V	CH	UMK105CH040CV-F	K22178252		4-	B	b3
C 1248	CHIP CAP.	0.01uF	16V	B	GRM36B103K16PT	K22128804		1-	B	a4
C 1248	CHIP CAP.	0.01uF	25V	B	GRM155B11E103KA01D	K22148834		90-	B	a4
C 1249	CHIP CAP.	47pF	50V	CH	UMK105CH470JV-F	K22178274		1-	A	C5
C 1249	CHIP CAP.	12pF	50V	CH	UMK105CH120JV-F	K22178260		61-	A	C5
C 1250	CHIP CAP.	0.001uF	50V	B	UMK105B102KW-F	K22178829		1-	B	a1
C 1251	CHIP CAP.	9pF	50V	CH	UMK105CH090DV-F	K22178257		1-	B	b3
C 1252	AL.ELECTRO.CAP.	10uF	16V		RV2-16V100MB55U-R	K48120014		1-	A	B4
C 1253	CHIP CAP.	0.001uF	50V	B	UMK105B102KW-F	K22178829		1-	A	E4
C 1254	CHIP CAP.	0.001uF	50V	B	UMK105B102KW-F	K22178829		1-	B	b2
C 1255	CHIP CAP.	10pF	50V	CH	UMK105CH100DV-F	K22178258		1-	A	B5
C 1255	CHIP CAP.	8pF	50V	CH	UMK105CH080DV-F	K22178256		61-	A	B5
C 1256	CHIP CAP.	7pF	50V	CH	UMK105CH070DV-F	K22178255		1-	B	b3
C 1257	CHIP CAP.	0.001uF	50V	B	UMK105B102KW-F	K22178829		1-	B	c3
C 1258	CHIP CAP.	0.0047uF	25V	B	TMK105B472KW-F	K22148831		1-	A	B4
C 1259	CHIP CAP.	0.01uF	16V	B	GRM36B103K16PT	K22128804		1-	B	b2
C 1259	CHIP CAP.	0.01uF	25V	B	GRM155B11E103KA01D	K22148834		90-	B	b2
C 1260	CHIP CAP.	0.01uF	16V	B	GRM36B103K16PT	K22128804		1-	B	a4
C 1260	CHIP CAP.	0.01uF	25V	B	GRM155B11E103KA01D	K22148834		90-	B	a4
C 1261	CHIP CAP.	47pF	50V	CH	UMK105CH470JV-F	K22178274		1-	B	a1
C 1262	CHIP CAP.	0.001uF	50V	B	UMK105B102KW-F	K22178829		1-	B	b3
C 1263	CHIP TA.CAP.	10uF	10V		TEESVA1A106M8R	K78100028		1-	B	c3
C 1264	CHIP CAP.	0.001uF	50V	B	UMK105B102KW-F	K22178829		1-	B	b3
C 1266	CHIP CAP.	0.01uF	16V	B	GRM36B103K16PT	K22128804		1-	A	B4
C 1266	CHIP CAP.	0.01uF	25V	B	GRM155B11E103KA01D	K22148834		90-	A	B4

# MAIN Unit

## Parts List

REF	DESCRIPTION	VALUE	V/W	TOL.	MFR'S DESIG	VXSTD P/N	VERS.	LOT	SIDE	LAYADR
C 1267	CHIP CAP.	18pF	50V	CH	UMK105CH180JV-F	K22178264		1-	A	D2
C 1268	CHIP CAP.	82pF	50V	UJ	GRM1553U1H820JZ01D	K22178322		1-	B	b2
C 1269	CHIP CAP.	0.01uF	16V	B	GRM36B103K16PT	K22128804		1-	A	D2
C 1269	CHIP CAP.	0.01uF	25V	B	GRM155B11E103KA01D	K22148834		90-	A	D2
C 1270	CHIP CAP.	0.001uF	50V	B	GRM188B11H102KA01D	K22174821		1-	A	E4
C 1271	CHIP CAP.	0.001uF	50V	B	GRM188B11H102KA01D	K22174821		1-	A	E4
C 1272	CHIP CAP.	0.001uF	50V	B	UMK105B102KW-F	K22178829		1-	B	b3
C 1273	CHIP CAP.	0.001uF	50V	B	UMK105B102KW-F	K22178829		1-	B	b4
C 1274	CHIP CAP.	1uF	10V	B	GRM21BB11A105KA01L	K22100802		1-	B	a5
C 1275	CHIP CAP.	0.022uF	16V	B	EMK105B223KW-F	K22128813		1-	B	a5
C 1276	CHIP CAP.	2pF	50V	CK	UMK105CK020CV-F	K22178250		1-	B	b2
C 1277	CHIP CAP.	82pF	50V	UJ	GRM1553U1H820JZ01D	K22178322		1-	B	b2
C 1278	CHIP CAP.	0.01uF	16V	B	GRM36B103K16PT	K22128804		1-	B	b4
C 1278	CHIP CAP.	0.01uF	25V	B	GRM155B11E103KA01D	K22148834		90-	B	b4
C 1279	CHIP CAP.	1uF	10V	B	GRM21BB11A105KA01L	K22100802		1-	B	a5
C 1280	CHIP CAP.	0.1uF	16V	B	GRM188B11C104KA01D	K22124805		1-	A	E4
C 1281	CHIP CAP.	0.1uF	16V	B	GRM188B11C104KA01D	K22124805		1-	A	E4
C 1282	CHIP TA. CAP.	10uF	10V		TEESVA1A106M8R	K78100028		1-	A	E4
C 1283	CHIP CAP.	0.01uF	16V	B	GRM36B103K16PT	K22128804		1-	B	a5
C 1283	CHIP CAP.	0.01uF	25V	B	GRM155B11E103KA01D	K22148834		90-	B	a5
C 1284	CHIP CAP.	15pF	50V	CH	UMK105CH150JV-F	K22178262		1-	A	D2
C 1285	CHIP CAP.	10pF	50V	CH	UMK105CH100DV-F	K22178258		1-	B	b4
C 1286	CHIP TA. CAP.	1uF	16V		TEESVA1C105M8R	K78120009		1-	B	a4
C 1287	CHIP CAP.	0.01uF	16V	B	GRM36B103K16PT	K22128804		1-	A	D3
C 1287	CHIP CAP.	0.01uF	25V	B	GRM155B11E103KA01D	K22148834		90-	A	D3
C 1288	CHIP CAP.	18pF	50V	CH	UMK105CH180JV-F	K22178264		1-	A	E3
C 1289	CHIP CAP.	0.01uF	16V	B	GRM36B103K16PT	K22128804		1-	A	D3
C 1289	CHIP CAP.	0.01uF	25V	B	GRM155B11E103KA01D	K22148834		90-	A	D3
C 1290	CHIP CAP.	0.001uF	50V	B	UMK105B102KW-F	K22178829		1-	B	b5
C 1291	CHIP CAP.	0.001uF	50V	B	UMK105B102KW-F	K22178829		1-	A	D2
C 1292	CHIP CAP.	0.001uF	50V	B	UMK105B102KW-F	K22178829		1-	B	a3
C 1293	CHIP TA. CAP.	4.7uF	10V		TEESVA21A475M8R	K78100045		1-	B	b1
C 1294	CHIP CAP.	0.1uF	16V	B	GRM188B11C104KA01D	K22124805		1-2	A	D3
C 1295	CHIP CAP.	0.01uF	16V	B	GRM36B103K16PT	K22128804		1-	B	b1
C 1295	CHIP CAP.	0.01uF	25V	B	GRM155B11E103KA01D	K22148834		90-	B	b1
C 1296	CHIP CAP.	0.001uF	50V	B	UMK105B102KW-F	K22178829		1-	B	b3
C 1297	CHIP CAP.	0.001uF	50V	B	UMK105B102KW-F	K22178829		1-2	A	D4
C 1298	CHIP CAP.	5pF	50V	CH	UMK105CH050CV-F	K22178253		1-	B	b3
C 1298	CHIP CAP.	15pF	50V	CH	UMK105CH150JV-F	K22178262		4-	B	b3
C 1298	CHIP CAP.	47pF	50V	CH	UMK105CH470JV-F	K22178274		76-	B	b3
C 1299	CHIP CAP.	0.001uF	50V	B	UMK105B102KW-F	K22178829		1-	A	D2
C 1300	CHIP CAP.	0.01uF	16V	B	GRM36B103K16PT	K22128804		1-	A	D4
C 1300	CHIP CAP.	0.01uF	25V	B	GRM155B11E103KA01D	K22148834		90-	A	D4
C 1301	CHIP CAP.	0.01uF	16V	B	GRM36B103K16PT	K22128804		1-	B	a1
C 1301	CHIP CAP.	0.01uF	25V	B	GRM155B11E103KA01D	K22148834		90-	B	a1
C 1302	CHIP CAP.	12pF	50V	CH	UMK105CH120JV-F	K22178260		1-	A	D3
C 1302	CHIP CAP.	8pF	50V	CH	UMK105CH080DV-F	K22178256		4-	A	D3
C 1302	CHIP CAP.	15pF	50V	CH	UMK105CH150JV-F	K22178262		25-	A	D3
C 1303	CHIP CAP.	0.001uF	50V	B	UMK105B102KW-F	K22178829		1-	B	b3
C 1304	CHIP CAP.	0.1uF	16V	B	GRM188B11C104KA01D	K22124805		1-	B	a1
C 1305	CHIP CAP.	22pF	50V	CH	UMK105CH220JV-F	K22178266		1-	A	D3
C 1305	CHIP CAP.	0.001uF	50V	B	UMK105B102KW-F	K22178829		25-	A	D3
C 1306	CHIP CAP.	0.01uF	16V	B	GRM36B103K16PT	K22128804		1-	A	D3
C 1306	CHIP CAP.	0.01uF	25V	B	GRM155B11E103KA01D	K22148834		90-	A	D3
C 1307	CHIP CAP.	0.01uF	16V	B	GRM36B103K16PT	K22128804		1-	B	a1
C 1307	CHIP CAP.	0.01uF	25V	B	GRM155B11E103KA01D	K22148834		90-	B	a1
C 1308	CHIP CAP.	0.001uF	50V	B	UMK105B102KW-F	K22178829		1-	A	D3
C 1308	CHIP CAP.	33pF	50V	CH	UMK105CH330JV-F	K22178270		25-	A	D3
C 1309	CHIP CAP.	0.01uF	16V	B	GRM36B103K16PT	K22128804		1-	A	D4
C 1309	CHIP CAP.	0.01uF	25V	B	GRM155B11E103KA01D	K22148834		90-	A	D4
C 1310	CHIP CAP.	0.1uF	16V	B	GRM188B11C104KA01D	K22124805		1-	A	B4
C 1311	CHIP CAP.	0.01uF	16V	B	GRM36B103K16PT	K22128804		1-	B	b1
C 1311	CHIP CAP.	0.01uF	25V	B	GRM155B11E103KA01D	K22148834		90-	B	b1
C 1312	CHIP TA. CAP.	4.7uF	6.3V		TEESVP0J475M8R	K78080053		1-	B	b2
C 1313	CHIP CAP.	0.01uF	16V	B	GRM36B103K16PT	K22128804		1-	A	D3
C 1313	CHIP CAP.	0.01uF	25V	B	GRM155B11E103KA01D	K22148834		90-	A	D3
C 1314	CHIP CAP.	15pF	50V	CH	UMK105CH150JV-F	K22178262		1-	A	D3
C 1314	CHIP CAP.	18pF	50V	CH	UMK105CH180JV-F	K22178264		25-	A	D3
C 1315	CHIP CAP.	0.033uF	10V	BJ	LMK105BJ333KV-F	K22108804		1-	A	B4
C 1316	CHIP CAP.	0.01uF	16V	B	GRM36B103K16PT	K22128804		1-	B	b3
C 1316	CHIP CAP.	0.01uF	25V	B	GRM155B11E103KA01D	K22148834		90-	B	b3
C 1318	CHIP CAP.	0.01uF	16V	B	GRM36B103K16PT	K22128804		1-	B	a3
C 1318	CHIP CAP.	0.01uF	25V	B	GRM155B11E103KA01D	K22148834		90-	B	a3

# MAIN Unit

## Parts List

REF	DESCRIPTION	VALUE	V/W	TOL.	MFR'S DESIG	VXSTD P/N	VERS.	LOT	SIDE	LAYADR
C 1319	CHIP CAP.	0.001uF	50V	B	UMK105B102KW-F	K22178829		1-	B	b1
C 1320	CHIP CAP.	0.01uF	50V	B	GRM40B103M50PT	K22170817		1-	A	C1
C 1320	CHIP CAP.	0.01uF	50V	B	GRM188B11H103KA01D	K22174823		4-	A	C1
C 1321	CHIP CAP.	0.01uF	16V	B	GRM36B103K16PT	K22128804		1-	A	C1
C 1321	CHIP CAP.	0.01uF	25V	B	GRM155B11E103KA01D	K22148834		90-	A	C1
C 1322	CHIP CAP.	0.01uF	16V	B	GRM36B103K16PT	K22128804		1-	A	C1
C 1322	CHIP CAP.	0.01uF	25V	B	GRM155B11E103KA01D	K22148834		90-	A	C1
C 1323	CHIP TA.CAP.	10uF	10V		TEESVA1A106M8R	K78100028		1-	A	C1
C 1324	CHIP TA.CAP.	2.2uF	10V		TEESVA1A225M8R	K78100021		1-	B	c2
C 1325	CHIP CAP.	0.0047uF	25V	B	TMK105B472KW-F	K22148831		1-	A	B4
C 1326	CHIP TA.CAP.	1uF	16V		TEESVA1C105M8R	K78120009		1-	B	c3
C 1327	CHIP CAP.	0.1uF	16V	B	GRM188B11C104KA01D	K22124805		1-	B	c2
C 1328	CHIP CAP.	0.01uF	16V	B	GRM36B103K16PT	K22128804		1-	B	d1
C 1328	CHIP CAP.	0.01uF	25V	B	GRM155B11E103KA01D	K22148834		90-	B	d1
C 1329	CHIP CAP.	0.01uF	16V	B	GRM36B103K16PT	K22128804		1-	B	d1
C 1329	CHIP CAP.	0.01uF	25V	B	GRM155B11E103KA01D	K22148834		90-	B	d1
C 1330	CHIP CAP.	0.01uF	16V	B	GRM36B103K16PT	K22128804		1-	B	c3
C 1330	CHIP CAP.	0.01uF	25V	B	GRM155B11E103KA01D	K22148834		90-	B	c3
C 1333	CHIP CAP.	0.01uF	16V	B	GRM36B103K16PT	K22128804		1-	A	B4
C 1333	CHIP CAP.	0.01uF	25V	B	GRM155B11E103KA01D	K22148834		90-	A	B4
C 1334	CHIP TA.CAP.	10uF	10V		TEESVA1A106M8R	K78100028		1-	A	C2
C 1336	CHIP TA.CAP.	0.47uF	25V		TEESVA1E474M8R	K78140009		1-	A	B1
C 1337	CHIP CAP.	0.01uF	16V	B	GRM36B103K16PT	K22128804		1-	B	d1
C 1337	CHIP CAP.	0.01uF	25V	B	GRM155B11E103KA01D	K22148834		90-	B	d1
C 1338	CHIP CAP.	0.01uF	16V	B	GRM36B103K16PT	K22128804		1-	A	D3
C 1338	CHIP CAP.	0.01uF	25V	B	GRM155B11E103KA01D	K22148834		90-	A	D3
C 1340	CHIP CAP.	0.1uF	16V	B	GRM188B11C104KA01D	K22124805		1-	A	C2
C 1341	CHIP CAP.	0.001uF	50V	B	UMK105B102KW-F	K22178829		1-	A	C2
C 1342	CHIP CAP.	0.1uF	16V	B	GRM188B11C104KA01D	K22124805		1-	A	C2
C 1344	CHIP CAP.	0.001uF	50V	B	UMK105B102KW-F	K22178829		1-	A	C1
C 1345	CHIP CAP.	0.1uF	16V	B	GRM188B11C104KA01D	K22124805		1-	B	d1
C 1346	CHIP CAP.	1uF	10V	B	GRM21BB11A105KA01L	K22100802		1-	B	c1
C 1347	CHIP TA.CAP.	10uF	10V		TEESVA1A106M8R	K78100028		1-	A	C2
C 1350	CHIP CAP.	0.01uF	16V	B	GRM36B103K16PT	K22128804		1-	A	D2
C 1350	CHIP CAP.	0.01uF	25V	B	GRM155B11E103KA01D	K22148834		90-	A	D2
C 1351	CHIP CAP.	0.047uF	10V	BJ	LMK105BJ473KV-F	K22108805		1-	B	d1
C 1352	CHIP CAP.	15pF	50V	CH	UMK105CH150JV-F	K22178262		1-	B	c3
C 1352	CHIP CAP.	33pF	50V	CH	UMK105CH330JV-F	K22178270		67-	B	c3
C 1353	CHIP CAP.	0.1uF	10V	B	GRM155B11A104KA01D	K22108802		1-	A	C2
C 1355	CHIP CAP.	15pF	50V	CH	UMK105CH150JV-F	K22178262		1-	A	C3
C 1356	CHIP CAP.	0.1uF	16V	B	GRM188B11C104KA01D	K22124805		1-	A	B3
C 1357	CHIP CAP.	1uF	10V	B	GRM21BB11A105KA01L	K22100802		1-	B	b2
C 1358	CHIP CAP.	1uF	10V	B	GRM21BB11A105KA01L	K22100802		1-	B	c2
C 1359	CHIP CAP.	100pF	50V	CH	UMK105CH101JV-F	K22178282		1-	A	D2
C 1360	CHIP CAP.	0.001uF	50V	B	UMK105B102KW-F	K22178829		1-	B	d1
C 1361	CHIP CAP.	1uF	10V	B	GRM21BB11A105KA01L	K22100802		1-	B	c1
C 1362	CHIP CAP.	0.1uF	16V	B	GRM188B11C104KA01D	K22124805		1-	B	c2
C 1363	CHIP CAP.	33pF	50V	CH	UMK105CH330JV-F	K22178270		1-	B	d3
C 1364	CHIP CAP.	0.1uF	16V	B	GRM188B11C104KA01D	K22124805		1-	B	d1
C 1365	CHIP CAP.	0.001uF	50V	B	UMK105B102KW-F	K22178829		1-	A	C2
C 1366	CHIP TA.CAP.	10uF	10V		TEESVA1A106M8R	K78100028		1-	A	C1
C 1367	CHIP CAP.	0.01uF	16V	B	GRM36B103K16PT	K22128804		1-	B	c3
C 1367	CHIP CAP.	0.01uF	25V	B	GRM155B11E103KA01D	K22148834		90-	B	c3
C 1368	CHIP CAP.	0.01uF	16V	B	GRM36B103K16PT	K22128804		1-	B	d3
C 1368	CHIP CAP.	0.01uF	25V	B	GRM155B11E103KA01D	K22148834		90-	B	d3
C 1369	CHIP CAP.	0.01uF	16V	B	GRM36B103K16PT	K22128804		1-	B	d1
C 1369	CHIP CAP.	0.01uF	25V	B	GRM155B11E103KA01D	K22148834		90-	B	d1
C 1370	CHIP CAP.	0.01uF	16V	B	GRM36B103K16PT	K22128804		1-	A	C2
C 1370	CHIP CAP.	0.01uF	25V	B	GRM155B11E103KA01D	K22148834		90-	A	C2
C 1371	CHIP CAP.	0.01uF	16V	B	GRM36B103K16PT	K22128804		1-	B	d1
C 1371	CHIP CAP.	0.01uF	25V	B	GRM155B11E103KA01D	K22148834		90-	B	d1
C 1372	CHIP TA.CAP.	10uF	10V		TEESVA1A106M8R	K78100028		1-	B	c2
C 1375	CHIP CAP.	0.1uF	16V	B	GRM188B11C104KA01D	K22124805		1-	B	d3
C 1376	CHIP CAP.	0.0033uF	50V	B	UMK105B332KW-F	K22178835		1-	A	D2
C 1378	CHIP CAP.	0.01uF	16V	B	GRM36B103K16PT	K22128804		1-	B	c2
C 1378	CHIP CAP.	0.01uF	25V	B	GRM155B11E103KA01D	K22148834		90-	B	c2
C 1379	CHIP CAP.	7pF	50V	CH	UMK105CH070DV-F	K22178255		1-	A	C3
C 1380	CHIP CAP.	270pF	25V	CH	GRM36CH271J25PT	K22148248		1-	B	d1
C 1380	CHIP CAP.	270pF	50V	CH	GRM155C1H271JA01D	K22179715		90-	B	d1
C 1381	CHIP CAP.	0.01uF	16V	B	GRM36B103K16PT	K22128804		1-	A	C2
C 1381	CHIP CAP.	0.01uF	25V	B	GRM155B11E103KA01D	K22148834		90-	A	C2
C 1382	CHIP CAP.	0.001uF	50V	B	UMK105B102KW-F	K22178829		1-	B	d1
C 1383	CHIP CAP.	0.0015uF	50V	B	UMK105B152KW-F	K22178831		1-	A	D2

# MAIN Unit

## Parts List

REF	DESCRIPTION	VALUE	V/W	TOL.	MFR'S DESIG	VXSTD P/N	VERS.	LOT	SIDE	LAYADR
C 1384	CHIP CAP.	1uF	10V	B	GRM21BB11A105KA01L	K22100802		1-	B	d4
C 1385	CHIP CAP.	1uF	10V	B	GRM21BB11A105KA01L	K22100802		1-	B	d4
C 1386	CHIP CAP.	220pF	25V	CH	TMK105CH221JV-F	K22148246		1-	B	d3
C 1387	CHIP TA.CAP.	10uF	10V		TEESVA1A106M8R	K78100028		1-	A	C2
C 1388	CHIP CAP.	0.01uF	16V	B	GRM36B103K16PT	K22128804		1-	A	C3
C 1388	CHIP CAP.	0.01uF	25V	B	GRM155B11E103KA01D	K22148834		90-	A	C3
C 1389	CHIP CAP.	0.01uF	16V	B	GRM36B103K16PT	K22128804		1-	A	C2
C 1389	CHIP CAP.	0.01uF	25V	B	GRM155B11E103KA01D	K22148834		90-	A	C2
C 1390	CHIP CAP.	0.01uF	16V	B	GRM36B103K16PT	K22128804		1-	B	d1
C 1390	CHIP CAP.	0.01uF	25V	B	GRM155B11E103KA01D	K22148834		90-	B	d1
C 1391	CHIP CAP.	100pF	50V	CH	UMK105CH101JV-F	K22178282		1-	B	d1
C 1392	CHIP CAP.	0.1uF	10V	B	GRM155B11A104KA01D	K22108802		1-	A	C2
C 1394	CHIP CAP.	100pF	50V	CH	UMK105CH101JV-F	K22178282		1-	B	d1
C 1395	CHIP CAP.	0.1uF	16V	B	GRM188B11C104KA01D	K22124805		1-	A	C2
C 1396	CHIP CAP.	1uF	10V	B	GRM21BB11A105KA01L	K22100802		1-	B	c1
C 1397	CHIP TA.CAP.	10uF	10V		TEESVA1A106M8R	K78100028		1-	B	c1
C 1398	CHIP CAP.	33pF	50V	CH	UMK105CH330JV-F	K22178270		1-	B	d3
C 1399	CHIP CAP.	0.01uF	16V	B	GRM36B103K16PT	K22128804		1-	A	C3
C 1399	CHIP CAP.	0.01uF	25V	B	GRM155B11E103KA01D	K22148834		90-	A	C3
C 1400	CHIP CAP.	0.01uF	50V	B	GRM40B103M50PT	K22170817		1-	A	C2
C 1400	CHIP CAP.	0.01uF	50V	B	GRM188B11H103KA01D	K22174823		4-	A	C2
C 1401	CHIP CAP.	0.01uF	16V	B	GRM36B103K16PT	K22128804		1-	A	C3
C 1401	CHIP CAP.	0.01uF	25V	B	GRM155B11E103KA01D	K22148834		90-	A	C3
C 1403	CHIP CAP.	0.01uF	16V	B	GRM36B103K16PT	K22128804		1-	A	C2
C 1403	CHIP CAP.	0.01uF	25V	B	GRM155B11E103KA01D	K22148834		90-	A	C2
C 1404	CHIP CAP.	0.1uF	16V	B	GRM188B11C104KA01D	K22124805		1-	B	d4
C 1405	CHIP CAP.	0.001uF	50V	B	UMK105B102KW-F	K22178829		1-	A	D3
C 1406	CHIP CAP.	33pF	50V	CH	UMK105CH330JV-F	K22178270		1-	B	d2
C 1406	CHIP CAP.	5pF	50V	CH	UMK105CH050CV-F	K22178253		25-	B	d2
C 1407	CHIP CAP.	56pF	50V	CH	UMK105CH560JV-F	K22178276		1-	B	d1
C 1408	CHIP CAP.	0.1uF	16V	B	GRM188B11C104KA01D	K22124805		1-	B	d1
C 1409	CHIP CAP.	2pF	50V	CK	GRM1554C1H2R0CZ01D	K22178204		1-	A	C2
C 1409	CHIP CAP.	2pF	50V	CK	UMK105CK020CV-F	K22178250		4-	A	C2
C 1410	CHIP CAP.	1uF	10V	B	GRM21BB11A105KA01L	K22100802		1-	B	c2
C 1411	CHIP CAP.	0.01uF	16V	B	GRM36B103K16PT	K22128804		1-	B	d1
C 1411	CHIP CAP.	0.01uF	25V	B	GRM155B11E103KA01D	K22148834		90-	B	d1
C 1412	CHIP CAP.	0.1uF	16V	B	GRM188B11C104KA01D	K22124805		1-	B	b2
C 1413	CHIP CAP.	0.1uF	16V	B	GRM188B11C104KA01D	K22124805		1-	A	B3
C 1414	CHIP CAP.	0.01uF	16V	B	GRM36B103K16PT	K22128804		1-	B	d3
C 1414	CHIP CAP.	0.01uF	25V	B	GRM155B11E103KA01D	K22148834		90-	B	d3
C 1415	CHIP CAP.	0.1uF	16V	B	GRM188B11C104KA01D	K22124805		1-	B	e1
C 1416	CHIP CAP.	0.1uF	16V	B	GRM188B11C104KA01D	K22124805		1-	B	d1
C 1417	CHIP CAP.	0.1uF	16V	B	GRM188B11C104KA01D	K22124805		1-	A	C2
C 1418	CHIP CAP.	0.01uF	16V	B	GRM36B103K16PT	K22128804		1-	A	C3
C 1418	CHIP CAP.	0.01uF	25V	B	GRM155B11E103KA01D	K22148834		90-	A	C3
C 1419	CHIP CAP.	0.01uF	16V	B	GRM36B103K16PT	K22128804		1-	B	d1
C 1419	CHIP CAP.	0.01uF	25V	B	GRM155B11E103KA01D	K22148834		90-	B	d1
C 1420	CHIP CAP.	0.1uF	16V	B	GRM188B11C104KA01D	K22124805		1-	A	B1
C 1421	CHIP CAP.	18pF	50V	CH	UMK105CH180JV-F	K22178264		1-	A	C3
C 1422	CHIP CAP.	10pF	50V	CH	UMK105CH100DV-F	K22178258		1-	B	d3
C 1422	CHIP CAP.	3pF	50V	CJ	UMK105CJ030CV-F	K22178251		83-	B	d3
C 1423	CHIP TA.CAP.	10uF	10V		TEESVA1A106M8R	K78100028		1-	A	B1
C 1424	CHIP CAP.	0.01uF	16V	B	GRM36B103K16PT	K22128804		1-	B	d1
C 1424	CHIP CAP.	0.01uF	25V	B	GRM155B11E103KA01D	K22148834		90-	B	d1
C 1425	CHIP CAP.	0.01uF	16V	B	GRM36B103K16PT	K22128804		1-	B	d1
C 1425	CHIP CAP.	0.01uF	25V	B	GRM155B11E103KA01D	K22148834		90-	B	d1
C 1426	CHIP CAP.	270pF	25V	CH	GRM36CH271J25PT	K22148248		1-	A	B1
C 1426	CHIP CAP.	270pF	50V	CH	GRM1552C1H271JA01D	K22179715		90-	A	B1
C 1427	CHIP CAP.	0.01uF	16V	B	GRM36B103K16PT	K22128804		1-	B	d2
C 1427	CHIP CAP.	0.01uF	25V	B	GRM155B11E103KA01D	K22148834		90-	B	d2
C 1428	CHIP CAP.	33pF	50V	CH	UMK105CH330JV-F	K22178270		1-	A	B3
C 1429	CHIP CAP.	0.1uF	16V	B	GRM188B11C104KA01D	K22124805		1-	B	e1
C 1430	CHIP CAP.	0.001uF	50V	B	UMK105B102KW-F	K22178829		1-	B	c2
C 1431	CHIP CAP.	0.1uF	10V	B	GRM155B11A104KA01D	K22108802		1-	A	C3
C 1432	CHIP CAP.	0.1uF	16V	B	GRM188B11C104KA01D	K22124805		1-	B	d3
C 1433	CHIP CAP.	47pF	50V	CH	UMK105CH470JV-F	K22178274		1	A	C3
C 1433	CHIP CAP.	56pF	50V	CH	UMK105CH560JV-F	K22178276		2-	A	C3
C 1433	CHIP CAP.	22pF	50V	CH	UMK105CH220JV-F	K22178266		4-	A	C3
C 1433	CHIP CAP.	39pF	50V	CH	UMK105CH390JV-F	K22178272		25-	A	C3
C 1433	CHIP CAP.	68pF	50V	CH	UMK105CH680JV-F	K22178278		76-	A	C3
C 1433	CHIP CAP.	0.01uF	25V	B	GRM155B11E103KA01D	K22148834		86-	A	C3
C 1434	CHIP CAP.	33pF	50V	CH	UMK105CH330JV-F	K22178270		1-	B	d2
C 1435	CHIP CAP.	1uF	10V	B	GRM21BB11A105KA01L	K22100802		1-	B	b1

# MAIN Unit

## Parts List

REF	DESCRIPTION	VALUE	V/W	TOL.	MFR'S DESIG	VXSTD P/N	VERS.	LOT	SIDE	LAYADR
C 1436	CHIP CAP.	0.01uF	16V	B	GRM36B103K16PT	K22128804		1-	B	c2
C 1436	CHIP CAP.	0.01uF	25V	B	GRM155B11E103KA01D	K22148834		90-	B	c2
C 1437	CHIP CAP.	0.1uF	16V	B	GRM188B11C104KA01D	K22124805		1-	B	d2
C 1439	CHIP CAP.	0.01uF	16V	B	GRM36B103K16PT	K22128804		1-	B	c5
C 1439	CHIP CAP.	0.01uF	25V	B	GRM155B11E103KA01D	K22148834		90-	B	c5
C 1440	CHIP CAP.	220pF	25V	CH	TMK105CH221JV-F	K22148246		1-	B	d2
C 1441	CHIP CAP.	0.01uF	16V	B	GRM36B103K16PT	K22128804		1-	A	B1
C 1441	CHIP CAP.	0.01uF	25V	B	GRM155B11E103KA01D	K22148834		90-	A	B1
C 1442	CHIP CAP.	0.1uF	16V	B	GRM188B11C104KA01D	K22124805		1-	B	d1
C 1443	CHIP CAP.	0.1uF	16V	B	GRM188B11C104KA01D	K22124805		1-	A	B3
C 1444	CHIP CAP.	0.01uF	16V	B	GRM36B103K16PT	K22128804		1-	B	c2
C 1444	CHIP CAP.	0.01uF	25V	B	GRM155B11E103KA01D	K22148834		90-	B	c2
C 1445	TANTALUM CAP.	10uF	10V		TPDN1A100M8S(MX0)	K76100006		1-	A	C2
C 1445	CHIP TA.CAP.	10uF	10V		TEESVA1A106M8R	K78100028		4-	A	C2
C 1446	CHIP CAP.	1uF	10V	B	GRM21BB11A105KA01L	K22100802		1-	B	d5
C 1447	CHIP CAP.	0.01uF	16V	B	GRM36B103K16PT	K22128804		1-	A	B3
C 1447	CHIP CAP.	0.01uF	25V	B	GRM155B11E103KA01D	K22148834		90-	A	B3
C 1448	CHIP CAP.	0.1uF	16V	B	GRM188B11C104KA01D	K22124805		1-	A	C2
C 1449	CHIP CAP.	0.1uF	16V	B	GRM188B11C104KA01D	K22124805		1-	B	d1
C 1450	CHIP CAP.	1uF	10V	B	GRM21BB11A105KA01L	K22100802		1-	B	d5
C 1451	CHIP CAP.	0.1uF	16V	B	GRM188B11C104KA01D	K22124805		1-	A	C3
C 1452	CHIP CAP.	0.0015uF	50V	B	UMK105B152KW-F	K22178831		1-	B	e5
C 1453	CHIP CAP.	0.0015uF	50V	B	UMK105B152KW-F	K22178831		1-	B	d5
C 1454	CHIP CAP.	0.0018uF	50V	B	GRM188B11H182KA01D	K22174812		1-	B	d4
C 1455	CHIP TA.CAP.	10uF	10V		TEESVA1A106M8R	K78100028		1-	B	d3
C 1456	CHIP CAP.	100pF	50V	CH	UMK105CH101JV-F	K22178282		1-	A	D2
C 1457	CHIP TA.CAP.	10uF	10V		TEESVA1A106M8R	K78100028		1-	B	c2
C 1458	CHIP CAP.	0.01uF	16V	B	GRM36B103K16PT	K22128804		1-	B	d2
C 1458	CHIP CAP.	0.01uF	25V	B	GRM155B11E103KA01D	K22148834		90-	B	d2
C 1459	CHIP TA.CAP.	10uF	10V		TEESVA1A106M8R	K78100028		1-	B	d5
C 1460	CHIP TA.CAP.	10uF	10V		TEESVA1A106M8R	K78100028		1-	B	d5
C 1461	CHIP TA.CAP.	10uF	10V		TEESVA1A106M8R	K78100028		1-	B	d5
C 1462	CHIP CAP.	0.1uF	16V	B	GRM188B11C104KA01D	K22124805		1-	B	d2
C 1463	CHIP CAP.	0.1uF	16V	B	GRM188B11C104KA01D	K22124805		1-	B	d5
C 1464	CHIP CAP.	1uF	10V	B	GRM21BB11A105KA01L	K22100802		1-	B	c2
C 1465	CHIP CAP.	0.012uF	50V	B	GRM188B11H123KA01D	K22174825		1-	B	d4
C 1466	CHIP CAP.	220pF	25V	CH	TMK105CH221JV-F	K22148246		1-	A	B3
C 1467	CHIP CAP.	0.01uF	16V	B	GRM36B103K16PT	K22128804		2-	B	d5
C 1467	CHIP CAP.	0.01uF	25V	B	GRM155B11E103KA01D	K22148834		90-	B	d5
C 1468	CHIP CAP.	0.1uF	16V	B	GRM188B11C104KA01D	K22124805		1-	B	d5
C 1469	CHIP CAP.	0.1uF	16V	B	GRM188B11C104KA01D	K22124805		1-	B	d5
C 1470	CHIP CAP.	0.01uF	16V	B	GRM36B103K16PT	K22128804		1-	A	C3
C 1470	CHIP CAP.	0.01uF	25V	B	GRM155B11E103KA01D	K22148834		90-	A	C3
C 1471	CHIP CAP.	33pF	50V	CH	UMK105CH330JV-F	K22178270		1-	B	d2
C 1472	CHIP CAP.	0.01uF	16V	B	GRM36B103K16PT	K22128804		1-	B	c2
C 1472	CHIP CAP.	0.1uF	10V	B	GRM155B11A104KA01D	K22108802		17-	B	c2
C 1473	CHIP CAP.	0.1uF	16V	B	GRM188B11C104KA01D	K22124805		1-	A	D2
C 1474	CHIP CAP.	0.0047uF	25V	B	TMK105B472KW-F	K22148831		1-	B	c1
C 1475	CHIP CAP.	0.1uF	16V	B	GRM188B11C104KA01D	K22124805		1-	B	c2
C 1476	CHIP TA.CAP.	2.2uF	10V		TEESVA1A225M8R	K78100021		1-	A	B3
C 1477	CHIP CAP.	0.1uF	16V	B	GRM188B11C104KA01D	K22124805		1-	A	B3
C 1478	CHIP CAP.	0.001uF	50V	B	UMK105B102KW-F	K22178829		1-	B	c3
C 1479	CHIP CAP.	0.1uF	16V	B	GRM188B11C104KA01D	K22124805		1-	A	B2
C 1480	CHIP CAP.	0.1uF	16V	B	GRM188B11C104KA01D	K22124805		1-	B	e1
C 1481	CHIP CAP.	100pF	50V	CH	UMK105CH101JV-F	K22178282		1-	B	c2
C 1482	CHIP CAP.	0.01uF	16V	B	GRM36B103K16PT	K22128804		1-	B	c1
C 1482	CHIP CAP.	0.01uF	25V	B	GRM155B11E103KA01D	K22148834		90-	B	c1
C 1483	CHIP CAP.	0.047uF	10V	BJ	LMK105BJ473KV-F	K22108805		1-	A	C1
C 1483	CHIP CAP.	0.1uF	10V	B	GRM155B11A104KA01D	K22108802		25-	A	C1
C 1484	CHIP CAP.	0.1uF	16V	B	GRM188B11C104KA01D	K22124805		1-	A	C1
C 1486	CHIP CAP.	0.01uF	16V	B	GRM36B103K16PT	K22128804		2-	B	d6
C 1486	CHIP CAP.	0.01uF	25V	B	GRM155B11E103KA01D	K22148834		90-	B	d6
C 1487	CHIP CAP.	0.0047uF	25V	B	TMK105B472KW-F	K22148831		1-	B	d4
C 1488	CHIP CAP.	0.1uF	16V	B	GRM188B11C104KA01D	K22124805		1-	A	B3
C 1489	CHIP CAP.	0.01uF	16V	B	GRM36B103K16PT	K22128804		2-	B	d5
C 1489	CHIP CAP.	0.01uF	25V	B	GRM155B11E103KA01D	K22148834		90-	B	d5
C 1490	CHIP CAP.	0.1uF	16V	B	GRM188B11C104KA01D	K22124805		1-	B	d3
C 1491	CHIP TA.CAP.	10uF	10V		TEESVA1A106M8R	K78100028		1-	A	C1
C 1492	CHIP CAP.	0.0047uF	25V	B	TMK105B472KW-F	K22148831		1-	B	c2
C 1493	CHIP CAP.	0.0056uF	25V	B	GRM155B11E562KA01D	K22148802		1-	B	d4
C 1494	CHIP CAP.	0.0047uF	25V	B	TMK105B472KW-F	K22148831		1-	B	e2
C 1495	CHIP CAP.	0.01uF	16V	B	GRM36B103K16PT	K22128804		1-	B	c1
C 1495	CHIP CAP.	0.01uF	25V	B	GRM155B11E103KA01D	K22148834		90-	B	c1

# MAIN Unit

## Parts List

REF	DESCRIPTION	VALUE	V/W	TOL.	MFR'S DESIG	VXSTD P/N	VERS.	LOT	SIDE	LAYADR
C 1496	CHIP CAP.	0.1uF	16V	B	GRM188B11C104KA01D	K22124805		1-	A	B2
C 1497	CHIP CAP.	0.1uF	16V	B	GRM188B11C104KA01D	K22124805		1-	A	D2
C 1498	CHIP CAP.	0.1uF	16V	B	GRM188B11C104KA01D	K22124805		1-	B	c2
C 1499	CHIP TA.CAP.	10uF	10V		TEESVA1A106M8R	K78100028		1-	B	d3
C 1500	CHIP CAP.	0.022uF	16V	B	EMK105B223KW-F	K22128813		1-	B	c1
C 1502	CHIP CAP.	0.001uF	50V	B	UMK105B102KW-F	K22178829		1-	B	c2
C 1503	CHIP TA.CAP.	1uF	16V		TEESVA1C105M8R	K78120009		1-	A	C1
C 1503	CHIP TA.CAP.	2.2uF	10V		TEESVA1A225M8R	K78100021		25-	A	C1
C 1504	CHIP CAP.	0.1uF	16V	B	GRM188B11C104KA01D	K22124805		1-	A	B2
C 1505	CHIP CAP.	1uF	10V	B	GRM21BB11A105KA01L	K22100802		1-	B	d4
C 1506	CHIP CAP.	0.0033uF	50V	B	UMK105B332KW-F	K22178835		1-	B	c2
C 1507	CHIP CAP.	1uF	10V	B	GRM21BB11A105KA01L	K22100802		1-	B	c1
C 1509	CHIP TA.CAP.	10uF	10V		TEESVA1A106M8R	K78100028		1-	A	B3
C 1510	CHIP CAP.	0.1uF	16V	B	GRM188B11C104KA01D	K22124805		1-	A	B3
C 1511	CHIP CAP.	10pF	50V	CH	UMK105CH100DV-F	K22178258		1-	B	d2
C 1512	CHIP CAP.	0.1uF	16V	B	GRM188B11C104KA01D	K22124805		1-	A	B3
C 1513	CHIP CAP.	0.01uF	16V	B	GRM36B103K16PT	K22128804		2-	B	d6
C 1513	CHIP CAP.	0.01uF	25V	B	GRM155B11E103KA01D	K22148834		90-	B	d6
C 1516	CHIP TA.CAP.	10uF	16V		TEESVB21C106M8R	K78120025		1-	B	d4
C 1517	CHIP TA.CAP.	22uF	16V		TEESVB21C226M8R	K78120028		1-	B	e4
C 1518	CHIP CAP.	10pF	50V	CH	UMK105CH100DV-F	K22178258		1-	B	d3
C 1519	CHIP CAP.	0.1uF	25V	F	GRM188F11E104ZA01D	K22145001		1-	B	e4
C 1519	CHIP CAP.	0.1uF	16V	B	GRM188B11C104KA01D	K22124805		4-	B	e4
C 1519	CHIP CAP.	1uF	10V	F	GRM188F11A105ZA01D	K22105001		14-	B	e4
C 1520	CHIP CAP.	47pF	50V	CH	UMK105CH470JV-F	K22178274		1-	B	d6
C 1521	CHIP CAP.	0.01uF	16V	B	GRM36B103K16PT	K22128804		2-	B	d5
C 1521	CHIP CAP.	0.01uF	25V	B	GRM155B11E103KA01D	K22148834		90-	B	d5
C 1522	CHIP CAP.	0.01uF	16V	B	GRM36B103K16PT	K22128804		2-	B	e5
C 1522	CHIP CAP.	0.01uF	25V	B	GRM155B11E103KA01D	K22148834		90-	B	e5
C 1523	CHIP CAP.	10pF	50V	CH	UMK105CH100DV-F	K22178258		1-	B	e6
C 1526	CHIP CAP.	33pF	50V	CH	UMK105CH330JV-F	K22178270		1-	B	e6
C 1528	CHIP CAP.	0.1uF	16V	B	GRM188B11C104KA01D	K22124805		1-	B	f3
C 1529	CHIP CAP.	0.1uF	16V	B	GRM188B11C104KA01D	K22124805		1-	B	e3
C 1530	CHIP CAP.	0.01uF	16V	B	GRM36B103K16PT	K22128804		1-	B	e3
C 1530	CHIP CAP.	0.01uF	25V	B	GRM155B11E103KA01D	K22148834		90-	B	e3
C 1531	CHIP CAP.	0.01uF	16V	B	GRM36B103K16PT	K22128804		1-	B	e3
C 1531	CHIP CAP.	0.01uF	25V	B	GRM155B11E103KA01D	K22148834		90-	B	e3
C 1532	AL.ELECTRO.CAP.	1000uF	16V		RE3-16V102MH3#	K40129096		1-	A	A4
C 1533	CHIP CAP.	0.1uF	16V	B	GRM188B11C104KA01D	K22124805		1-	B	f3
C 1534	CHIP CAP.	0.1uF	16V	B	GRM188B11C104KA01D	K22124805		1-	B	e3
C 1535	CHIP CAP.	0.01uF	16V	B	GRM36B103K16PT	K22128804		1-	B	e4
C 1535	CHIP CAP.	0.1uF	10V	B	GRM155B11A104KA01D	K22108802		14-	B	e4
C 1536	CHIP CAP.	0.1uF	16V	B	GRM188B11C104KA01D	K22124805		1-	B	d2
C 1537	CHIP CAP.	0.1uF	16V	B	GRM188B11C104KA01D	K22124805		1-	B	d2
C 1539	CHIP CAP.	0.01uF	16V	B	GRM36B103K16PT	K22128804		1-	B	e2
C 1539	CHIP CAP.	0.01uF	25V	B	GRM155B11E103KA01D	K22148834		90-	B	e2
C 1540	CHIP CAP.	1uF	10V	B	GRM21BB11A105KA01L	K22100802		1-	B	e4
C 1541	AL.ELECTRO.CAP.	1000uF	16V		RE3-16V102MH3#	K40129096		1-	A	A4
C 1542	AL.ELECTRO.CAP.	47uF	16V		EEE1CA470SP	K48120005		1-	A	A4
C 1543	CHIP CAP.	0.1uF	16V	B	GRM188B11C104KA01D	K22124805		1-	B	d2
C 1544	CHIP CAP.	0.1uF	16V	B	GRM188B11C104KA01D	K22124805		1-	B	d2
C 1545	CHIP CAP.	0.1uF	16V	B	GRM188B11C104KA01D	K22124805		1-	B	f1
C 1546	CHIP CAP.	0.1uF	16V	B	GRM188B11C104KA01D	K22124805		1-	B	e1
C 1547	CHIP CAP.	0.01uF	16V	B	GRM36B103K16PT	K22128804		1-	B	d2
C 1547	CHIP CAP.	0.01uF	25V	B	GRM155B11E103KA01D	K22148834		90-	B	d2
C 1548	CHIP CAP.	0.01uF	16V	B	GRM36B103K16PT	K22128804		1-	B	e1
C 1548	CHIP CAP.	0.01uF	25V	B	GRM155B11E103KA01D	K22148834		90-	B	e1
C 1549	CHIP CAP.	0.01uF	16V	B	GRM36B103K16PT	K22128804		1-	B	e1
C 1549	CHIP CAP.	0.01uF	25V	B	GRM155B11E103KA01D	K22148834		90-	B	e1
C 1550	AL.ELECTRO.CAP.	470uF	16V		RE3-16V471MG3#	K40129066		1-	A	A4
C 1551	CHIP CAP.	0.1uF	16V	B	GRM188B11C104KA01D	K22124805		1-	B	e4
C 1552	CHIP CAP.	0.1uF	16V	B	GRM188B11C104KA01D	K22124805		1-	B	e2
C 1554	CHIP TA.CAP.	10uF	10V		TEESVA1A106M8R	K78100028		1-	B	e6
C 1555	CHIP CAP.	1uF	10V	B	GRM21BB11A105KA01L	K22100802		1-	B	e6
C 1557	CHIP CAP.	47pF	50V	CH	UMK105CH470JV-F	K22178274		1-	B	e6
C 1558	CHIP CAP.	100pF	50V	CH	UMK105CH101JV-F	K22178282		1-	B	e6
C 1559	CHIP CAP.	0.001uF	50V	B	UMK105B102KW-F	K22178829		1-	B	f6
C 1560	CHIP CAP.	10pF	50V	CH	UMK105CH100DV-F	K22178258		1-	B	d2
C 1562	CHIP CAP.	100pF	50V	CH	UMK105CH101JV-F	K22178282		1-	B	c1
C 1563	CHIP CAP.	0.001uF	50V	B	UMK105B102KW-F	K22178829		1-	B	f6
C 1564	CHIP CAP.	1uF	10V	B	GRM21BB11A105KA01L	K22100802		1-	B	c1
C 1565	CHIP CAP.	0.001uF	50V	B	UMK105B102KW-F	K22178829		1-	B	c1
C 1566	CHIP CAP.	100pF	50V	CH	UMK105CH101JV-F	K22178282		1-	B	c1



# MAIN Unit

## Parts List

REF	DESCRIPTION	VALUE	V/W	TOL.	MFR'S DESIG	VXSTD P/N	VERS.	LOT	SIDE	LAYADR
C 1567	CHIP TA.CAP.	10uF	10V		TEESVA1A106M8R	K78100028		1-	A	A6
C 1569	CHIP CAP.	0.1uF	16V	B	GRM188B11C104KA01D	K22124805		1-	B	e6
C 1570	CHIP CAP.	0.001uF	50V	B	UMK105B102KW-F	K22178829		1-	A	A6
C 1572	CHIP CAP.	0.001uF	50V	B	UMK105B102KW-F	K22178829		1-	B	e1
C 1573	CHIP CAP.	0.001uF	50V	B	UMK105B102KW-F	K22178829		1-	A	D1
C 1574	CHIP CAP.	0.001uF	50V	B	UMK105B102KW-F	K22178829		1-	B	c1
C 1575	CHIP CAP.	0.001uF	50V	B	UMK105B102KW-F	K22178829		1-	B	d1
C 1576	CHIP CAP.	0.001uF	50V	B	UMK105B102KW-F	K22178829		1-	B	d1
C 1577	CHIP CAP.	0.001uF	50V	B	UMK105B102KW-F	K22178829		1-	B	d1
C 1578	CHIP CAP.	0.001uF	50V	B	UMK105B102KW-F	K22178829		1-	B	d1
C 1579	CHIP CAP.	0.001uF	50V	B	UMK105B102KW-F	K22178829		1-	B	c1
C 1580	CHIP CAP.	0.001uF	50V	B	UMK105B102KW-F	K22178829		1-	A	A6
C 1581	CHIP CAP.	1uF	10V	F	GRM188F11A105ZA01D	K22105001		1-	A	B6
C 1582	CHIP CAP.	0.001uF	50V	B	UMK105B102KW-F	K22178829		1-	B	e1
C 1583	CHIP CAP.	0.001uF	50V	B	UMK105B102KW-F	K22178829		1-	B	d1
C 1587	CHIP CAP.	0.01uF	50V	B	GRM188B11H103KA01D	K22174823		1-	B	c1
C 1588	CHIP CAP.	0.001uF	50V	B	UMK105B102KW-F	K22178829		1-	B	c1
C 1589	CHIP CAP.	0.001uF	50V	B	UMK105B102KW-F	K22178829		1-	B	e6
C 1590	CHIP CAP.	0.001uF	50V	B	UMK105B102KW-F	K22178829		1-	B	e6
C 1593	CHIP CAP.	0.001uF	50V	B	UMK105B102KW-F	K22178829		1-	B	e1
C 1594	CHIP CAP.	0.001uF	50V	B	UMK105B102KW-F	K22178829		1-	B	f1
C 1595	CHIP CAP.	0.01uF	16V	B	GRM36B103K16PT	K22128804		25-	A	A6
C 1595	CHIP CAP.	0.01uF	25V	B	GRM155B11E103KA01D	K22148834		90-	A	A6
C 1596	CHIP CAP.	0.1uF	16V	B	GRM188B11C104KA01D	K22124805		25-	A	A6
C 1597	CHIP CAP.	12pF	50V	CH	UMK105CH120JV-F	K22178260		1-	A	E5
C 1598	CHIP CAP.	5pF	50V	CH	GRM1552C1H5R0CZ01D	K22178207		1-	A	E5
C 1598	CHIP CAP.	5pF	50V	CH	UMK105CH050CV-F	K22178253		4-	A	E5
C 1599	CHIP CAP.	4pF	50V	CH	GRM1552C1H4R0CZ01D	K22178206		1-	A	E5
C 1599	CHIP CAP.	4pF	50V	CH	UMK105CH040CV-F	K22178252		4-	A	E5
C 1600	CHIP CAP.	68pF	50V	CH	UMK105CH680JV-F	K22178278		1-	A	C2
C 1601	CHIP CAP.	22pF	50V	CH	UMK105CH220JV-F	K22178266		1-	B	d2
C 1601	CHIP CAP.	15pF	50V	CH	UMK105CH150JV-F	K22178262		25-	B	d2
C 1602	CHIP CAP.	15pF	50V	CH	UMK105CH150JV-F	K22178262		1-	B	c3
C 1603	CHIP CAP.	47pF	50V	CH	UMK105CH470JV-F	K22178274		1-	A	B3
C 1604	CHIP CAP.	47pF	50V	CH	UMK105CH470JV-F	K22178274		1-	B	d3
C 1605	CHIP CAP.	68pF	50V	CH	UMK105CH680JV-F	K22178278		1-	B	d3
C 1606	CHIP CAP.	100pF	50V	CH	UMK105CH101JV-F	K22178282		1-	B	d3
C 1607	CHIP CAP.	15pF	50V	CH	UMK105CH150JV-F	K22178262		1-	A	D1
C 1608	CHIP CAP.	33pF	50V	CH	UMK105CH330JV-F	K22178270		1-	A	B2
C 1608	CHIP CAP.	100pF	50V	CH	UMK105CH101JV-F	K22178282		83-	A	B2
C 1609	CHIP CAP.	100pF	50V	CH	UMK105CH101JV-F	K22178282		1-	A	D2
C 1610	CHIP CAP.	0.1uF	16V	B	GRM188B11C104KA01D	K22124805		1-	B	c1
C 1613	CHIP CAP.	15pF	50V	CH	GRM1882C1H150JA01D	K22174215		1-	A	D6
C 1613	CHIP CAP.	12pF	50V	CH	GRM1882C1H120JA01D	K22174213		52-	A	D6
C 1614	CHIP CAP.	3pF	50V	CJ	GRM1883C1H3R0CZ01D	K22174204		1-	B	b6
C 1615	CHIP CAP.	1uF	10V	B	GRM21BB11A105KA01L	K22100802		1-	B	a3
C 1616	CHIP CAP.	15pF	50V	CH	UMK105CH150JV-F	K22178262		1-	A	F3
C 1617	CHIP CAP.	0.001uF	50V	B	UMK105B102KW-F	K22178829		1-	B	d3
C 1618	CHIP CAP.	0.001uF	50V	B	UMK105B102KW-F	K22178829		1-	B	a1
C 1619	CHIP CAP.	7pF	50V	CH	GRM1552C1H7R0DZ01D	K22178209		1-	A	E5
C 1619	CHIP CAP.	7pF	50V	CH	UMK105CH070DV-F	K22178255		4-	A	E5
C 1619	CHIP CAP.	5pF	50V	CH	UMK105CH050CV-F	K22178253		52-	A	E5
C 1620	CHIP CAP.	10pF	50V	CH	GRM1552C1H100JZ01D	K22178212		1-	A	E5
C 1620	CHIP CAP.	10pF	50V	CH	UMK105CH100DV-F	K22178258		4-	A	E5
C 1633	CHIP CAP.	100pF	50V	CH	UMK105CH101JV-F	K22178282		1-	A	D3
C 1634	CHIP CAP.	100pF	50V	CH	UMK105CH101JV-F	K22178282		1-	A	D4
C 1635	CHIP CAP.	100pF	50V	CH	UMK105CH101JV-F	K22178282		1-	A	D4
C 1636	CHIP CAP.	100pF	50V	CH	UMK105CH101JV-F	K22178282		1-	A	D3
C 1637	CHIP CAP.	100pF	50V	CH	UMK105CH101JV-F	K22178282		1-	A	D3
C 1638	CHIP CAP.	100pF	50V	CH	UMK105CH101JV-F	K22178282		1-	A	D4
C 1639	CHIP CAP.	100pF	50V	CH	UMK105CH101JV-F	K22178282		1-	A	D3
C 1640	CHIP CAP.	100pF	50V	CH	UMK105CH101JV-F	K22178282		1-	A	D3
C 1641	CHIP CAP.	100pF	50V	CH	UMK105CH101JV-F	K22178282		1-	A	D3
C 1642	CHIP CAP.	100pF	50V	CH	UMK105CH101JV-F	K22178282		1-	A	D3
C 1643	CHIP CAP.	0.001uF	50V	B	UMK105B102KW-F	K22178829		1-	B	c4
C 1647	CHIP CAP.	10pF	50V	CH	UMK105CH100DV-F	K22178258		1-	B	b3
C 1648	CHIP CAP.	0.01uF	16V	B	GRM36B103K16PT	K22128804		1-	A	B6
C 1648	CHIP CAP.	0.01uF	25V	B	GRM155B11E103KA01D	K22148834		90-	A	B6
C 1650	CHIP CAP.	0.001uF	50V	B	GRM188B11H102KA01D	K22174821		1-	B	a5
C 1650	CHIP CAP.	220pF	50V	CH	GRM1882C1H221JA01D	K22174243		14-	B	a5
C 1650	CHIP CAP.	150pF	50V	CH	GRM1882C1H151JA01D	K22174239		21-	B	a5
C 1650	CHIP CAP.	100pF	50V	CH	GRM1882C1H101JA01D	K22174235		25-	B	a5
C 1650	CHIP CAP.	100pF	50V	CH	GRM1882C1H101JA01D	K22174235		38-49	B	a5

# MAIN Unit

## Parts List

REF	DESCRIPTION	VALUE	V/W	TOL.	MFR'S DESIG	VXSTD P/N	VERS.	LOT	SIDE	LAYADR
C 1651	CHIP CAP.	0.001uF	50V	B	UMK105B102KW-F	K22178829		1-	A	C5
C 1652	TANTALUM CAP.	10uF	10V		TPDN1A100M8S(MX0)	K76100006		1-	A	E5
C 1652	CHIP TA.CAP.	10uF	10V		TEESVA1A106M8R	K78100028		4-	A	E5
C 1656	CHIP CAP.	10pF	50V	CH	UMK105CH100DV-F	K22178258		1-24	B	b3
C 1660	CHIP CAP.	0.1uF	10V	B	GRM155B11A104KA01D	K22108802		1-	A	B5
C 1661	CHIP CAP.	0.0015uF	50V	B	GRM188B11H152KA01D	K22174827		1-	B	e5
C 1661	CHIP CAP.	0.0033uF	50V	B	GRM188B11H332KA01D	K22174831		9-	B	e5
C 1661	CHIP CAP.	0.01uF	50V	B	GRM188B11H103KA01D	K22174823		14-	B	e5
C 1661	CHIP CAP.	0.01uF	16V	B	GRM36B103K16PT	K22128804		25-	B	e5
C 1661	CHIP CAP.	0.01uF	25V	B	GRM155B11E103KA01D	K22148834		90-	B	e5
C 1662	CHIP CAP.	4pF	50V	CH	UMK105CH040CV-F	K22178252		1-	B	e6
C 1663	CHIP CAP.	100pF	50V	CH	GRM1552C1H101JD01D	K22178236	W/ CE LABEL	25-	A	C5
C 1664	CHIP CAP.	100pF	50V	CH	GRM1552C1H101JD01D	K22178236	W/ CE LABEL	25-	A	C7
C 1668	CHIP CAP.	0.001uF	50V	B	UMK105B102KW-F	K22178829	W/ CE LABEL	25-	B	f1
C 1674	CHIP CAP.	22pF	50V	CH	UMK105CH220JV-F	K22178266		25-	A	F4
C 1675	CHIP CAP.	0.01uF	16V	B	GRM36B103K16PT	K22128804		14-	A	F4
C 1675	CHIP CAP.	0.01uF	25V	B	GRM155B11E103KA01D	K22148834		90-	A	F4
C 1676	CHIP CAP.	0.047uF	10V	BJ	LMK105BJ473KV-F	K22108805		14		
C 1677	CHIP CAP.	0.01uF	16V	B	GRM36B103K16PT	K22128804		15-	B	a6
C 1677	CHIP CAP.	0.01uF	25V	B	GRM155B11E103KA01D	K22148834		90-	B	a6
C 1678	CHIP CAP.	0.33uF	16V	B	GRM21BB11C334KA01L	K22120807		15-	B	c2
C 1679	CHIP CAP.	0.001uF	50V	B	UMK105B102KW-F	K22178829		25-	B	d1
C 1680	CHIP CAP.	0.015uF	16V	B	GRM155B11C153KA01D	K22128807		17-	B	c1
C 1680	CHIP CAP.	0.0047uF	50V	B	GRM155B11H472KA01D	K22178838		86-	B	c1
C 1681	CHIP CAP.	18pF	50V	CH	UMK105CH180JV-F	K22178264		25-	A	D3
C 1682	CHIP CAP.	1uF	10V	F	GRM188F11A105ZA01D	K22105001		25-	A	B5
C 1683	CHIP CAP.	0.01uF	16V	B	GRM36B103K16PT	K22128804		25-	B	a5
C 1683	CHIP CAP.	0.01uF	25V	B	GRM155B11E103KA01D	K22148834		90-	B	a5
C 1684	CHIP CAP.	4pF	50V	CH	GRM1882C1H4R0CZ01D	K22174205		50-		
C 1684	CHIP CAP.	4pF	50V	CH	GRM1882C1H4R0CZ01D	K22174205		86-		
C 1685	CHIP CAP.	0.001uF	50V	B	UMK105B102KW-F	K22178829		81-		
C 1901	CHIP CAP.	100pF	50V	CH	GRM1882C1H101JA01D	K22174235	W/ CE LABEL	4-24		
C 1902	CHIP CAP.	100pF	50V	CH	GRM1882C1H101JA01D	K22174235	W/ CE LABEL	4-24		
CD1001	CERAMIC DISC				CDACV10M7GA001-R0-TC	H7901420		1-	A	E5
CD1002	CERAMIC DISC				CDBCBA455KCAAY24-R0	H7900980		1-	A	B1
CF1001	CERAMIC FILTER				SFECV10M7FA00-R0-TC	H3900537		1-	A	E4
CF1002	CERAMIC FILTER				ALFYM455E=K	H3900543		1-	A	B2
CF1003	CERAMIC FILTER				ALFYM455G=K	H3900545		1-	A	B1
CF1004	CERAMIC FILTER				CFJ455K14	H3900386		1-	A	C2
CF1005	CERAMIC FILTER				ALFYM455H=K	H3900542		1-	A	B2
CV1001	HELICAL RESONATOR	440MHZ			H5T-440 440M	L4020161		1-	A	D4
D 1001	DIODE				DAP236U T106	G2070592		1-	B	c4
D 1002	DIODE				DAP236U T106	G2070592		1-	B	c4
D 1003	DIODE				HSC277TRF-E	G2070584		1-	A	D4
D 1004	DIODE				BAS316	G2070716		1-	B	a6
D 1005	DIODE				BAS316	G2070716		1-	B	a6
D 1006	DIODE				UDZ TE-17 5.6B	G2070552		1-	B	a6
D 1006	DIODE				UDZS TE-17 5.6B	G2070910		7-	B	a6
D 1007	DIODE				HSC277TRF-E	G2070584		1-	B	c4
D 1008	DIODE				1SV278(TPH2.F)	G2070616		1-	B	b4
D 1009	DIODE				1SV278(TPH2.F)	G2070616		1-	B	c5
D 1010	DIODE				1SS302(TE85R.F)	G2070088		1-	B	c4
D 1011	DIODE				DAP236U T106	G2070592		1-	B	c4
D 1012	DIODE				DAP236U T106	G2070592		1-	B	b4
D 1013	DIODE				BAS316	G2070716		1-	B	c4
D 1014	DIODE				1SV278(TPH2.F)	G2070616		1-	B	b4
D 1015	DIODE				1SV278(TPH2.F)	G2070616		1-	B	b4
D 1016	DIODE				HSC277TRF-E	G2070584		1-	A	D4
D 1017	DIODE				1SV278(TPH2.F)	G2070616		1-	B	b5
D 1018	DIODE				DAP236U T106	G2070592		1-	B	a4
D 1019	DIODE				DAP236U T106	G2070592		1-	A	F4
D 1020	DIODE				RB051L-40TE25	G2070718		1-	B	e5
D 1023	DIODE				1SV278(TPH2.F)	G2070616		1-	A	E4
D 1024	DIODE				1SV278(TPH2.F)	G2070616		1-	A	F4
D 1025	DIODE				DAP236U T106	G2070592		1-	B	b4
D 1026	DIODE				1SV278(TPH2.F)	G2070616		1-	A	E4
D 1027	DIODE				1SV278(TPH2.F)	G2070616		1-	A	F4
D 1028	DIODE				1SV278(TPH2.F)	G2070616		1-	A	E4
D 1029	DIODE				MA132WK-(TX)	G2070776		1-	B	e5
D 1029	DIODE				DAN222 TL	G2070174		21-	B	e5
D 1030	DIODE				DAP236U T106	G2070592		1-	B	a3
D 1031	DIODE				DAP236U T106	G2070592		1-	A	F3
D 1032	DIODE				MC2850-T111-1	G2070704		1-	A	B4

# MAIN Unit

## Parts List

REF	DESCRIPTION	VALUE	V/W	TOL.	MFR'S DESIG	VXSTD P/N	VERS.	LOT	SIDE	LAYADR
D 1032	DIODE				DAN217U T106	G2071236		98-	A	B4
D 1033	DIODE				DAN222 TL	G2070174		1-	B	e5
D 1034	DIODE				HSB88WS TR-E	G2070290		1-	A	E3
D 1035	DIODE				DAP236U T106	G2070592		1-	B	b4
D 1036	DIODE				HSC277TRF-E	G2070584		1-	B	b4
D 1037	DIODE				DA221 TL	G2070178		1-	B	b2
D 1038	DIODE				1SV217(TPH3)	G2070568		1-	A	E4
D 1038	DIODE				1SV262(TPH3)	G2071106		67-	A	E4
D 1039	DIODE				DAN235U TL	G2070176		1-	B	a3
D 1040	DIODE				1SV271(TPH3.F)	G2070476		1-	B	b3
D 1041	DIODE				BAS316	G2070716		1-	B	a4
D 1043	DIODE				DA221 TL	G2070178		1-	A	D2
D 1044	DIODE				IMN10 T108	G2070078		1-	A	A5
D 1045	DIODE				HSC277TRF-E	G2070584		1-	B	a3
D 1046	DIODE				1SV229(TPH3.F)	G2070256		1-	A	D2
D 1047	DIODE				IMN10 T108	G2070078		1-	A	A5
D 1048	DIODE				IMN10 T108	G2070078		1-	A	A5
D 1049	DIODE				DAN235U TL	G2070176		1-	B	b3
D 1050	DIODE				DAN235U TL	G2070176		1-	B	b3
D 1051	DIODE				BAS316	G2070716		1-	A	D2
D 1052	DIODE				BAS316	G2070716		1-	B	d1
D 1053	DIODE				BAS316	G2070716		1-	B	c2
D 1054	DIODE				DAN235U TL	G2070176		1-	B	c3
D 1055	DIODE				BAS316	G2070716		1-	B	c2
D 1056	DIODE				BAS316	G2070716		1-	A	C1
D 1057	DIODE				DA221 TL	G2070178		1-	B	d1
D 1058	DIODE				1SS372(TE85R.F)	G2070632		1-	B	b2
D 1059	DIODE				BAS316	G2070716		1-	B	c2
D 1060	DIODE				1SV271(TPH3.F)	G2070476		1-	A	C3
D 1061	DIODE				1SS372(TE85R.F)	G2070632		1-	A	C2
D 1062	DIODE				BAS316	G2070716		1-	A	C3
D 1063	DIODE				DAP222-TL	G2070432		1-	B	d1
D 1064	DIODE				1SS372(TE85R.F)	G2070632		1-	A	B3
D 1065	DIODE				DAP222-TL	G2070432		1-	B	e1
D 1066	DIODE				BAS316	G2070716		1-	B	d3
D 1068	DIODE				BAS316	G2070716		1-	A	C2
D 1069	DIODE				DAN222 TL	G2070174		1-	B	d2
D 1070	DIODE				DAN222 TL	G2070174		1-	B	d3
D 1071	DIODE				BAS316	G2070716		1-	B	e2
D 1072	DIODE				DAP222-TL	G2070432		1-	B	e3
D 1076	DIODE				DAP222-TL	G2070432		1-	B	e2
D 1077	DIODE				HZM27WA TR-E	G2070530		1-	B	e6
D 1078	DIODE				DAP222-TL	G2070432		1-	B	d2
D 1079	DIODE				DAP222-TL	G2070432		1-	A	A1
D 1080	DIODE				HZM27WA TR-E	G2070530		1-	B	d6
D 1081	DIODE				D1F20-5063	G2070474		1-	B	b1
D 1081	DIODE				D1F60-5053	G2071240		105-	B	b1
D 1082	DIODE				BAS316	G2070716		1-	B	e4
D 1083	DIODE				DAN222 TL	G2070174		1-	A	B4
D 1084	DIODE				1SS270TJ	G2060004		17-	B	c2
D 1084	DIODE				BAS316	G2070716		25-	B	c2
D 1087	DIODE				UDZS TE-17 5.1B	G2070908		25-	A	C3
D 1088	DIODE				UDZS TE-17 5.1B	G2070908		25-	B	d2
D 1089	DIODE				UDZS TE-17 5.1B	G2070908		25-	B	d2
D 1090	DIODE				UDZS TE-17 5.1B	G2070908		25-	A	D3
D 1091	DIODE				BAS316	G2070716		25-	A	C1
D 1092	DIODE				1SV271(TPH3.F)	G2070476		25-49	B	a5
D 1093	DIODE				HVC132TRF-E	G2071064		50-	B	a5
F 1001	CHIPFUSE	3.15A			KAB2402-322NA31010	Q0000087		1-	A	D1
FB1002	CHIP COIL				BLM21PG300SN1D	L1690840		1-	A	E6
FB1003	CHIP COIL				BLM21PG300SN1D	L1690840		1-	A	F6
FB1004	CHIP COIL				BLM21PG300SN1D	L1690840		1-	A	E6
FB1005	FERRITE BEADS				SMB304729	L9190094		1-	A	E6
FB1006	CHIP COIL				BLM21PG300SN1D	L1690840		1-	A	E6
FB1007	CHIP COIL				BLM21PG300SN1D	L1690840		1-	B	a6
FB1008	CHIP COIL				BLM21PG300SN1D	L1690840		1-	B	f1
FB1009	CHIP COIL				BLM21PG300SN1D	L1690840		1-	B	c1
FB1010	CHIP COIL				BLM21PG300SN1D	L1690840		1-	B	d1
FB1011	CHIP COIL				BLM21PG300SN1D	L1690840		1-	A	A6
FB1012	CHIP COIL				BLM21PG300SN1D	L1690840		1-	A	A6
FB1013	CHIP COIL				BLM21PG300SN1D	L1690840		1-	B	e6
FB1014	CHIP COIL				BLM21PG300SN1D	L1690840		1-	B	c1
J 1001	CONNECTOR				24FLT-SM2-TB(LF)(SN)(M)	P1091128		1-	A	F6

# MAIN Unit

## Parts List

REF	DESCRIPTION	VALUE	V/W	TOL.	MFR'S DESIG	VXSTD P/N	VERS.	LOT	SIDE	LAYADR
J 1002	CONNECTOR				TMP-J01X-A2	P1090255		1-	A	C6
J 1002	CONNECTOR				TMP-S01X-C1	P1091254		58-	A	C6
J 1003	CONNECTOR				TMP-J01X-A2	P1090255		1-	A	C5
J 1003	CONNECTOR				TMP-S01X-C1	P1091254		58-	A	C5
J 1004	CONNECTOR				IMSA-9202B-1-02-T	P0091174		1-	A	C5
J 1005	CONNECTOR				M50006020-IIBA R41-9553D	P1090925		1-	A	C1
J 1006	CONNECTOR				M50-008-020 R41-9553F	P1091132		1-	A	C1
J 1009	CONNECTOR				SB20-02WS	P0090609		1-	A	A1
J 1010	CONNECTOR				B7B-ZR(LF)(SN)	P0090649		1-	A	A4
J 1011	CONNECTOR				HSJ0912-01-041	P1090749		1-	A	A1
J 1012	CONNECTOR				HSJ0912-01-040	P1091129		1-	A	B1
J 1013	CONNECTOR				SG8035#01	P1090350		1-	A	A1
J 1013	CONNECTOR				S-G8036#01	P1091390		118-	A	A1
J 1017	CONNECTOR				SB20-08WS	P0090615		1-	A	A6
J 1018	CONNECTOR				SB20-06WS	P0090613		1-	A	B6
J 1019	CONNECTOR				9210B-1-03Z172-T	P0091282		1-		
J 1020	CONNECTOR				9210B-1-04Z172-T	P0091283		1-		
J 1021	CONNECTOR				9210B-1-04Z172-T	P0091283		1-		
J 1022	CONNECTOR				9210B-1-03Z172-T	P0091282		1-		
J 1023	CONNECTOR				9210B-1-04Z172-T	P0091283		1-		
J 1024	CONNECTOR				9210B-1-03Z172-T	P0091282		1-		
J 1027	CONNECTOR				IMSA-9202B-1-03-T	P0091291		25-	A	D1
JP1051	WIRE ASSY				GRN 30 (3)/(3)	T51503012		1-3		
JP1052	WIRE ASSY				GRN 45 2/2	T50504500		1-3		
JP1053	WIRE ASSY				GRN 20 2/2	T50502000		1-3		
JP1054	WIRE ASSY				GRN 20 2/2	T50502000		1-24		
JP1055	WIRE ASSY				GRN 20 2/2	T50502000		1-24		
L 1001	COIL				E2 0.4-3.0-9.5T-L	L0022575		1-	A	C6
L 1002	M.RFC	10uH			CDRH74-100MC	L1690599		1-	A	C6
L 1003	CHIPCOIL	330uH			LQH32MN331K23L	L1690105		1-	B	c5
L 1004	COIL				E2 0.4-3.0-9.5T-L	L0022575		1-	A	C6
L 1005	M.RFC	10uH			CDRH74-100MC	L1690599		1-	A	C5
L 1006	M.RFC	0.022uH			HK1608 22NJ-T	L1690520		1-	A	D6
L 1007	M.RFC	0.022uH			HK1608 22NJ-T	L1690520		1-	A	D6
L 1008	M.RFC	0.0027uH			HK1608 2N7S-T	L1690509		1-	A	D6
L 1009	M.RFC	0.0027uH			HK1608 2N7S-T	L1690509		1-	A	D6
L 1010	M.RFC	10uH			CDRH74-100MC	L1690599		1-	A	D6
L 1011	COIL				E2 0.3-1.7-7T-R	L0022372		1-	A	D6
L 1012	M.RFC	0.039uH			HK1608 39NJ-T	L1690523		1-	B	b6
L 1013	M.RFC	0.0056uH			HK1608 5N6S-T	L1690513		1-	B	b6
L 1014	M.RFC	10uH			7B05NB-100M	L1690988		1-	A	D5
L 1014	M.RFC	10uH			7E05NB-100M	L1691221		23-	A	D5
L 1015	COIL				E2 0.25-1.85-8.5T-L	L0022576		1-	A	D5
L 1016	M.RFC	0.039uH			HK1608 39NJ-T	L1690523		1-	B	b5
L 1016	M.RFC	0.022uH			HK1608 22NJ-T	L1690520		86-	B	b5
L 1017	M.RFC	0.012uH			HK1608 12NJ-T	L1690517		1-	B	b5
L 1018	M.RFC	4.7uH			ELJ-FC4R7KF	L1690348		1-	A	E5
L 1019	M.RFC	0.056uH			HK1608 56NJ-T	L1690525		1-	B	b5
L 1019	M.RFC	0.022uH			HK1608 22NJ-T	L1690520		21-	B	b5
L 1019	M.RFC	0.039uH			HK1608 39NJ-T	L1690523		86-	B	b5
L 1020	M.RFC	0.068uH			HK1608 68NJ-T	L1690526		1-	B	c4
L 1021	M.RFC	15uH			LAL03TA150K	L1790097		1-	A	E5
L 1023	M.RFC	10uH			LK1608 100K-T	L1690689		1-	A	E5
L 1024	M.RFC	0.015uH			HK1608 15NJ-T	L1690518		1-	B	c4
L 1025	M.RFC	0.022uH			HK1608 22NJ-T	L1690520		1-	B	c4
L 1026	CHIPCOIL	0.1uH			C2520C-R10J	L1690544		1-	B	a4
L 1027	COIL				E2 0.28-1.0-4T-R	L0022365		1-	A	E4
L 1028	CHIPCOIL	0.47uH			C2520C-R47J	L1690552		1-	B	a4
L 1029	CHIPCOIL	0.047uH			C2520C-47NK	L1690540		1-	B	a4
L 1030	CHIPCOIL	0.27uH			C2520C-R27J	L1690549		1-	B	a4
L 1030	CHIPCOIL	0.18uH			C2520C-R18J	L1690547		17-	B	a4
L 1030	CHIPCOIL	0.39uH			C2520C-R39G-RA	L1691301		86-	B	a4
L 1031	COIL			2%	E2 0.28-1.0-4T-R	L0022365		1-	A	E4
L 1032	CHIPCOIL	0.47uH			C2520C-R47J	L1690552		1-	B	a4
L 1033	CHIPCOIL	0.22uH			C2520C-R22J	L1690548		1-	B	a4
L 1033	CHIPCOIL	0.15uH			C2520C-R15J	L1690546		17-	B	a4
L 1033	CHIPCOIL	0.33uH			C2520C-R33G-RA	L1691300		86-	B	a4
L 1034	CHIPCOIL	0.1uH		2%	C2520C-R10J	L1690544		1-	B	a3
L 1035	COIL				E2 0.28-1.0-4T-R	L0022365		1-	A	E3
L 1036	M.RFC	0.12uH			LK1608 R12K-T	L1690408		1-	B	b4
L 1037	CHIPCOIL	0.082uH			C2520C-82NK	L1690543		1-	A	F3
L 1038	M.RFC	0.15uH			LK1608 R15K-T	L1690409		1-	B	b4
L 1039	M.RFC	4.7uH			LK1608 4R7K-T	L1690688		1-	B	a1

# MAIN Unit

## Parts List

REF	DESCRIPTION	VALUE	V/W	TOL.	MFR'S DESIG	VXSTD P/N	VERS.	LOT	SIDE	LAYADR
L 1040	CHIP COIL	0.033uH			C2520C-33NK	L1690538		1-	A	E5
L 1041	CHIP COIL	0.33uH			C2520C-R33J	L1690550		1-	A	E4
L 1042	M.RFC	10uH			LK1608 100K-T	L1690689		1-	B	a1
L 1043	M.RFC	10uH			LK1608 100K-T	L1690689		1-	B	a1
L 1044	CHIP COIL	0.033uH			C2520C-33NK	L1690538		1-	A	E4
L 1045	M.RFC	2.2uH			LK1608 2R2K-T	L1690634		1-	B	b2
L 1046	CHIP COIL	330uH			LQH32MN331K23L	L1690105		1-	A	D4
L 1047	M.RFC	0.15uH			HK1608 R15J-T	L1690938		1-	B	b3
L 1048	COIL				E2 0.25-1.85-8.5T-L	L0022576		1-	A	E4
L 1049	COIL 05RF				M5-N1 R12-T660Y	L0022673		1-	A	D2
L 1049	COIL 05RF				2.7UH 020812327	L0022833		5-	A	D2
L 1050	M.RFC	10uH			LK1608 100K-T	L1690689		1-	B	b1
L 1051	M.RFC	10uH			LK1608 100K-T	L1690689		1-	B	a1
L 1052	M.RFC	10uH			LK1608 100K-T	L1690689		1-	A	D3
L 1053	M.RFC	10uH			LK1608 100K-T	L1690689		1-	A	D3
L 1054	M.RFC	470uH			FLC32T-471J	L1690235		1-	B	d3
L 1055	M.RFC	470uH			FLC32T-471J	L1690235		1-	A	C2
L 1056	M.RFC	470uH			FLC32T-471J	L1690235		1-	B	d2
L 1057	CHIP COIL	10uH			C2520F-100K	L1690596		1-	B	c5
L 1057	CHIP COIL	10uH		5%	NLV-25T-100J-PF	L1691436		71-	B	c5
L 1058	CHIP COIL	10uH			C2520F-100K	L1690596		1-	B	c5
L 1058	CHIP COIL	10uH		5%	NLV-25T-100J-PF	L1691436		71-	B	c5
L 1059	CHIP COIL	10uH			C2520F-100K	L1690596		1-	B	c5
L 1059	CHIP COIL	10uH		5%	NLV-25T-100J-PF	L1691436		71-80	B	c5
L 1059	CHIP COIL	0.01uH		2%	C2520C-10NG-RA	L1691283		82-	B	c5
L 1060	M.RFC	470uH			FLC32T-471J	L1690235		1-	B	c3
L 1061	M.RFC	22uH			LK2125 220M-T	L1690335		1-	A	B6
L 1062	M.RFC	22uH			LK2125 220M-T	L1690335		1-	A	B6
L 1063	M.RFC	22uH			LK2125 220M-T	L1690335		1-	A	B6
L 1064	M.RFC	22uH			LK2125 220M-T	L1690335		1-	A	B6
L 1065	M.RFC	22uH			LK2125 220M-T	L1690335		1-	A	B6
L 1066	M.RFC	22uH			LK2125 220M-T	L1690335		1-	A	B6
L 1067	COIL				E2 0.26-0.9-3T-R	L0022367		1-	A	E5
L 1068	COIL				E2 0.28-1.0-4T-R	L0022365		1-	A	E5
L 1069	M.RFC	0.015uH			HK1608 15NJ-T	L1690518		25-	A	F4
P 1001	CONNECTOR				IMSA-9206H-T	P1090988		1-		
P 1002	CONNECTOR				IMSA-9206H-T	P1090988		25-		
Q 1001	FET				2SK2975-T11	G3829757		1-	A	D6
Q 1001	FET				RD07MVS1-T12	G3070320		21-	A	D6
Q 1002	FET				2SK2975-T11	G3829757		1-	A	D6
Q 1002	FET				RD07MVS1-T12	G3070320		21-	A	D6
Q 1003	IC				BU4094BCFV-E2	G1093527		1-	A	C4
Q 1003	IC				CD4094BPWR	G1093866		23-	A	C4
Q 1004	IC				BU4094BCFV-E2	G1093527		1-	A	C4
Q 1004	IC				CD4094BPWR	G1093866		23-	A	C4
Q 1005	TRANSISTOR				2SC4154-T111-1E	G3341548E		1-	B	a6
Q 1005	TRANSISTOR				2SC4081 T106	G3340818		98-	B	a6
Q 1006	FET				2SK2973-T13	G3829738		1-	A	E6
Q 1006	FET				RD01MUS1-T113	G3070321		21-	A	E6
Q 1007	FET				2SK2973-T13	G3829738		1-	A	E6
Q 1007	FET				RD01MUS1-T113	G3070321		21-	A	E6
Q 1008	TRANSISTOR				2SC4154-T111-1E	G3341548E		1-	B	a6
Q 1008	TRANSISTOR				2SC4081 T106	G3340818		98-	B	a6
Q 1009	TRANSISTOR				2SC4154-T111-1E	G3341548E		1-	B	a6
Q 1009	TRANSISTOR				2SC4081 T106	G3340818		98-	B	a6
Q 1010	IC				BU4094BCFV-E2	G1093527		1-	A	C4
Q 1010	IC				CD4094BPWR	G1093866		23-	A	C4
Q 1011	FET				2SK2596BXTL-E	G3825967		1-	B	b6
Q 1012	TRANSISTOR				2SC4154-T111-1E	G3341548E		1-	B	a6
Q 1012	TRANSISTOR				2SC4081 T106	G3340818		98-	B	a6
Q 1013	TRANSISTOR				2SB624-T2B BV3	G3206247C		1-	A	E5
Q 1014	IC				KIA7808API	G1093164		1-	A	F5
Q 1015	TRANSISTOR				FMG5 T148	G3070021		1-	A	E5
Q 1016	IC				M62352GP-70EC	G1092689		1-	A	C4
Q 1017	TRANSISTOR				2SC3357-T2	G3333577		1-	B	b5
Q 1018	TRANSISTOR				UMC5N TR	G3070137		1-	A	E5
Q 1019	IC				BA05FP-E2	G1093209		1-	B	a5
Q 1020	TRANSISTOR				2SB624-T2B BV3	G3206247C		1-	A	E5
Q 1021	TRANSISTOR				RT1N241M-T11-1	G3070249		1-	B	c4
Q 1021	TRANSISTOR				DTC124EU T106	G3070045		98-	B	c4
Q 1022	IC				UPC2710T-E3	G1091844		1-	B	a5
Q 1022	IC				UPC2710TB-E3	G1093932		25-	B	a5
Q 1023	IC				BB304CDW-TL	G1093324		1-	B	b4

# MAIN Unit

## Parts List

REF	DESCRIPTION	VALUE	V/W	TOL.	MFR'S DESIG	VXSTD P/N	VERS.	LOT	SIDE	LAYADR
Q 1024	IC				BB304CDW-TL	G1093324		1-	B	b5
Q 1025	TRANSISTOR				2SC5374-TL	G3353748		1-	B	c4
Q 1026	FET				2SK2685ZT-TR	G3826857		1-	B	c4
Q 1026	FET				NE34018-T1	G3070328		25-	B	c4
Q 1026	FET				NE3509M04-T2-A	G3070387		100-	B	c4
Q 1027	TRANSISTOR				UMH6NTR	G3070216		1-	B	c4
Q 1028	IC				M5278L05M 600C	G1093101		1-	B	f5
Q 1028	IC				TA78L05F(TE12L.F)	G1091014		4-	B	f5
Q 1028	IC				BA05FP-E2	G1093209		25-	B	f5
Q 1029	TRANSISTOR				UMD2NTR	G3070076		1-	B	b4
Q 1030	IC				PST3445UR	G1093232		1-	B	e5
Q 1031	FET				2SJ355-T1	G3703558		1-	B	e5
Q 1032	TRANSISTOR				RT1N241M-T11-1	G3070249		1-	B	e5
Q 1032	TRANSISTOR				DTC124EU T106	G3070045		98-	B	e5
Q 1033	TRANSISTOR				UMC5NTR	G3070137		1-	B	c5
Q 1034	TRANSISTOR				UMC5NTR	G3070137		1-	B	b4
Q 1035	TRANSISTOR				RT1N241M-T11-1	G3070249		1-	B	e5
Q 1035	TRANSISTOR				DTC124EU T106	G3070045		98-	B	e5
Q 1036	TRANSISTOR				2SA1602A-T111-1F	G3116028F		1-	A	A5
Q 1036	TRANSISTOR				ISA1602AM1-T111-1F	G3070380		86-	A	A5
Q 1036	TRANSISTOR				2SA1576A T106 R	G3115768R		98-	A	A5
Q 1037	TRANSISTOR				2SC4154-T111-1E	G3341548E		1-	A	A5
Q 1037	TRANSISTOR				2SC4081 T106	G3340818		98-	A	A5
Q 1038	IC				TC4W53FU(TE12L_F)	G1091675		1-	A	B4
Q 1039	TRANSISTOR				2SC4154-T111-1E	G3341548E		1-	B	e5
Q 1039	TRANSISTOR				2SC4081 T106	G3340818		98-	B	e5
Q 1040	TRANSISTOR				2SA1602A-T111-1F	G3116028F		1-	B	e5
Q 1040	TRANSISTOR				ISA1602AM1-T111-1F	G3070380		86-	B	e5
Q 1040	TRANSISTOR				2SA1576A T106 R	G3115768R		98-	B	e5
Q 1041	TRANSISTOR				2SC4400-3-TL	G3344008C		1-	B	b2
Q 1042	TRANSISTOR				2SC4154-T111-1E	G3341548E		1-	B	b2
Q 1042	TRANSISTOR				2SC4081 T106	G3340818		98-	B	b2
Q 1043	TRANSISTOR				2SC4400-3-TL	G3344008C		1-	B	a1
Q 1044	TRANSISTOR				2SC4154-T111-1E	G3341548E		1-	B	c3
Q 1044	TRANSISTOR				2SC4081 T106	G3340818		98-	B	c3
Q 1045	TRANSISTOR				2SC4154-T111-1E	G3341548E		1-	B	c3
Q 1045	TRANSISTOR				2SC4081 T106	G3340818		98-	B	c3
Q 1046	TRANSISTOR				2SC4400-3-TL	G3344008C		1-	B	a1
Q 1047	TRANSISTOR				RT1N241M-T11-1	G3070249		1-	A	B4
Q 1047	TRANSISTOR				DTC124EU T106	G3070045		98-	A	B4
Q 1048	TRANSISTOR				2SC4400-3-TL	G3344008C		1-	B	a1
Q 1049	IC				HD64F2134FA20(FLASH)	G1093341		1-	A	B5
Q 1049	IC				HD64F2134ATF20V(FLASH)	G1093985		25-	A	B5
Q 1050	TRANSISTOR				2SA1602A-T111-1F	G3116028F		1-	B	c2
Q 1050	TRANSISTOR				ISA1602AM1-T111-1F	G3070380		86-	B	c2
Q 1050	TRANSISTOR				2SA1576A T106 R	G3115768R		98-	B	c2
Q 1051	TRANSISTOR				2SC4400-3-TL	G3344008C		1-	B	b2
Q 1052	TRANSISTOR				2SC4400-3-TL	G3344008C		1-	B	b2
Q 1053	TRANSISTOR				DTC114EUA T106	G3070084		1-	A	B5
Q 1054	TRANSISTOR				2SC4154-T111-1E	G3341548E		1-	B	a4
Q 1054	TRANSISTOR				2SC4081 T106	G3340818		98-	B	a4
Q 1055	TRANSISTOR				2SC4154-T111-1E	G3341548E		1-	B	b3
Q 1055	TRANSISTOR				2SC4081 T106	G3340818		98-	B	b3
Q 1056	TRANSISTOR				2SC4400-3-TL	G3344008C		1-	B	b2
Q 1057	TRANSISTOR				2SC4154-T111-1E	G3341548E		1-	A	D2
Q 1057	TRANSISTOR				2SC4081 T106	G3340818		98-	A	D2
Q 1058	IC				CXA1611N-T4	G1092695		1-	B	a4
Q 1059	TRANSISTOR				2SC4400-3-TL	G3344008C		1-	B	a1
Q 1060	TRANSISTOR				UMC5NTR	G3070137		1-	A	D2
Q 1061	IC				BB304CDW-TL	G1093324		1-	B	b3
Q 1061	IC				BB301CAW-TL	G1093186		25-	B	b3
Q 1062	IC				AD9835BRUZ-REEL7	G1093142		1-	B	b1
Q 1063	TRANSISTOR				UMC5NTR	G3070137		1-	B	b5
Q 1064	TRANSISTOR				2SC4154-T111-1E	G3341548E		1-	A	D4
Q 1064	TRANSISTOR				2SC4081 T106	G3340818		98-	A	D4
Q 1065	IC				24LC128T-I/SN	G1093668		1-	A	C5
Q 1066	IC				BU4053BCFV-E2	G1093422		1-	B	d4
Q 1066	IC				CD4053BPWR	G1093864		23-	B	d4
Q 1067	IC				TC4W53FU(TE12L_F)	G1091675		1-	B	d4
Q 1068	TRANSISTOR				2SC4154-T111-1E	G3341548E		1-	B	c2
Q 1068	TRANSISTOR				2SC4081 T106	G3340818		98-	B	c2
Q 1069	TRANSISTOR				2SC4154-T111-1E	G3341548E		1-	A	C1
Q 1069	TRANSISTOR				2SC4081 T106	G3340818		98-	A	C1

# MAIN Unit

## Parts List

REF	DESCRIPTION	VALUE	V/W	TOL.	MFR'S DESIG	VXSTD P/N	VERS.	LOT	SIDE	LAYADR
Q 1070	TRANSISTOR				2SC4154-T111-1E	G3341548E		1-	B	c2
Q 1070	TRANSISTOR				2SC4081 T106	G3340818		98-	B	c2
Q 1071	IC				SA602AD/01.118	G1093612		1-	A	C2
Q 1073	IC				BB305CEW-TL	G1093677		1-	B	c3
Q 1073	IC				BB301CAW-TL	G1093186		25-	B	c3
Q 1074	TRANSISTOR				2SC4154-T111-1E	G3341548E		1-	B	d1
Q 1074	TRANSISTOR				2SC4081 T106	G3340818		98-	B	d1
Q 1075	IC				BB305CEW-TL	G1093677		1-	B	d3
Q 1076	TRANSISTOR				2SC4154-T111-1E	G3341548E		1-	B	c2
Q 1076	TRANSISTOR				2SC4081 T106	G3340818		98-	B	c2
Q 1077	TRANSISTOR				2SC4154-T111-1E	G3341548E		1-	A	C3
Q 1077	TRANSISTOR				2SC4081 T106	G3340818		98-	A	C3
Q 1078	TRANSISTOR				2SC4154-T111-1E	G3341548E		1-	B	e1
Q 1078	TRANSISTOR				2SC4081 T106	G3340818		98-	B	e1
Q 1079	IC				BB305CEW-TL	G1093677		1-	B	d3
Q 1080	IC				TA31136FNG(EL)	G1091605		1-	B	d1
Q 1081	IC				BB305CEW-TL	G1093677		1-	B	d2
Q 1081	IC				BB301CAW-TL	G1093186		25-	B	d2
Q 1082	IC				SA602AD/01.118	G1093612		1-	A	C2
Q 1083	FET				2SK302Y(TE85R.F)	G3803027Y		1-	B	d3
Q 1084	FET				2SK302Y(TE85R.F)	G3803027Y		1-	B	d3
Q 1085	TRANSISTOR				2SC4154-T111-1E	G3341548E		1-	A	B3
Q 1085	TRANSISTOR				2SC4081 T106	G3340818		98-	A	B3
Q 1086	TRANSISTOR				RT1N241M-T11-1	G3070249		1-	A	B1
Q 1086	TRANSISTOR				DTC124EU T106	G3070045		98-	A	B1
Q 1087	IC				M62364FP 600D	G1093033		1-	B	b1
Q 1088	IC				BB305CEW-TL	G1093677		1-	B	d2
Q 1088	IC				BB301CAW-TL	G1093186		25-	B	d2
Q 1089	IC				BB304CDW-TL	G1093324		1-	B	c3
Q 1090	TRANSISTOR				2SC4154-T111-1E	G3341548E		1-	A	C1
Q 1090	TRANSISTOR				2SC4081 T106	G3340818		98-	A	C1
Q 1091	TRANSISTOR				RT1N241M-T11-1	G3070249		1-	B	d1
Q 1091	TRANSISTOR				DTC124EU T106	G3070045		98-	B	d1
Q 1092	IC				AK7712VT	G1092699		1-	B	d5
Q 1092	IC				AK7712AVT	G1093815		25-	B	d5
Q 1093	TRANSISTOR				2SC4154-T111-1E	G3341548E		1-	A	B3
Q 1093	TRANSISTOR				2SC4081 T106	G3340818		98-	A	B3
Q 1094	TRANSISTOR				2SC4154-T111-1E	G3341548E		1-	B	e2
Q 1094	TRANSISTOR				2SC4081 T106	G3340818		98-	B	e2
Q 1095	IC				TA75S01F(TE85R.F)	G1091593		1-	A	C1
Q 1096	TRANSISTOR				2SC4154-T111-1E	G3341548E		1-	B	d3
Q 1096	TRANSISTOR				2SC4081 T106	G3340818		98-	B	d3
Q 1097	TRANSISTOR				2SC4154-T111-1E	G3341548E		1-	B	d3
Q 1097	TRANSISTOR				2SC4081 T106	G3340818		98-	B	d3
Q 1098	IC				TC4W53FU(TE12L_F)	G1091675		1-	B	b2
Q 1099	TRANSISTOR				2SA1602A-T111-1F	G3116028F		1-	B	e3
Q 1099	TRANSISTOR				ISA1602AM1-T111-1F	G3070380		86-	B	e3
Q 1099	TRANSISTOR				2SA1576A T106 R	G3115768R		98-	B	e3
Q 1100	IC				TC4S66F(TE85R.F)	G1090893		1-	A	C1
Q 1102	TRANSISTOR				DTC114EUA T106	G3070084		1-	B	d6
Q 1103	IC				M51132FP 600C	G1091930		1-	B	e4
Q 1104	TRANSISTOR				FMG5 T148	G3070021		1-	B	e2
Q 1105	IC				TDA2003H	G1090815		1-	A	A4
Q 1106	TRANSISTOR				FMG5 T148	G3070021		1-	B	e2
Q 1107	TRANSISTOR				RT1N241M-T11-1	G3070249		1-	B	e2
Q 1107	TRANSISTOR				DTC124EU T106	G3070045		98-	B	e2
Q 1108	TRANSISTOR				2SD2211 T100 QR	G3422117Q		1-	B	b1
Q 1109	TRANSISTOR				2SC4154-T111-1E	G3341548E		1-	B	e6
Q 1109	TRANSISTOR				2SC4081 T106	G3340818		98-	B	e6
Q 1110	TRANSISTOR				DTC114EUA T106	G3070084		1-	B	e4
Q 1111	IC				NJM2902V-TE1	G1091679		1-	B	a6
Q 1112	IC				NJM2904V-TE1	G1091677		1-	B	a6
Q 1113	IC				BU4011BF-E2	G1092724		1-	A	B6
Q 1114	IC				NJM2902V-TE1	G1091679		1-	A	B4
Q 1115	IC				NJM2902V-TE1	G1091679		1-	B	d5
Q 1116	IC				NJM2902V-TE1	G1091679		1-	B	d5
Q 1117	IC				NJM2904V-TE1	G1091677		1-	B	c3
Q 1118	IC				NJM2902V-TE1	G1091679		1-	B	c1
Q 1119	IC				NJM2902V-TE1	G1091679		1-	B	c2
Q 1120	IC				NJM2902V-TE1	G1091679		1-	A	D2
Q 1121	IC				BU4066BCFV-E2	G1093537		1-	A	D1
Q 1121	IC				CD4066BPWR	G1093865		23-	A	D1
Q 1122	IC				BU4066BCFV-E2	G1093537		1-	A	D1

# MAIN Unit

## Parts List

REF	DESCRIPTION	VALUE	V/W	TOL.	MFR'S DESIG	VXSTD P/N	VERS.	LOT	SIDE	LAYADR
Q 1122	IC				CD4066BPWR	G1093865		23-	A	D1
Q 1122	IC				BU4066BCFV-E2	G1093537		25-	A	D1
Q 1123	IC				NJM2904V-TE1	G1091677		1-	B	c1
Q 1124	TRANSISTOR				UMH6NTR	G3070216		1-	A	A3
Q 1125	TRANSISTOR				UMH6NTR	G3070216		1-	B	e3
Q 1126	TRANSISTOR				UMH6NTR	G3070216		1-	B	e1
Q 1128	IC				SPM5001-TL-E	G1093686		1-	A	E3
Q 1129	IC				TC4S81F(TE85R.F)	G1090895		1-	A	B6
R 1001	CHIPRES.	470	1/16W	5%	RMC1/16S 471JTH	J24189021		1-	B	a6
R 1002	CHIPRES.	470	1/16W	5%	RMC1/16S 471JTH	J24189021		1-	B	a6
R 1003	CHIPRES.	470	1/16W	5%	RMC1/16S 471JTH	J24189021		1-	B	a6
R 1004	CHIPRES.	470	1/16W	5%	RMC1/16S 471JTH	J24189021		1-	B	a6
R 1005	CHIPRES.	470	1/16W	5%	RMC1/16S 471JTH	J24189021		1-	B	a6
R 1006	CHIPRES.	470	1/16W	5%	RMC1/16S 471JTH	J24189021		1-	A	F6
R 1007	CHIPRES.	470	1/16W	5%	RMC1/16S 471JTH	J24189021		1-	A	F6
R 1008	CHIPRES.	470	1/16W	5%	RMC1/16S 471JTH	J24189021		1-	A	F6
R 1010	CHIPRES.	470	1W	5%	RMC1 471JTE	J24305471		1-	B	c6
R 1011	CHIPRES.	470	1W	5%	RMC1 471JTE	J24305471		1-	B	c6
R 1012	CHIPRES.	470	1/16W	5%	RMC1/16S 471JTH	J24189021		1-	B	c5
R 1013	CHIPRES.	220	1W	5%	RMC1 221JTE	J24305221		1-	A	D5
R 1014	CHIPRES.	220	1W	5%	RMC1 221JTE	J24305221		1-	A	D6
R 1015	CHIPRES.	330	1/16W	5%	RMC1/16 331JATP	J24185331		1-	A	D5
R 1015	CHIPRES.	820	1/16W	5%	RMC1/16 821JATP	J24185821		21-	A	D5
R 1016	CHIPRES.	56	1/16W	5%	RMC1/16 560JATP	J24185560		1-	A	D6
R 1017	CHIPRES.	220	1/16W	5%	RMC1/16 221JATP	J24185221		1-	A	D6
R 1017	CHIPRES.	470	1/16W	5%	RMC1/16 471JATP	J24185471		21-	A	D6
R 1018	CHIPRES.	100k	1/16W	5%	RMC1/16S 104JTH	J24189049		1-	B	a6
R 1019	CHIPRES.	100k	1/16W	5%	RMC1/16S 104JTH	J24189049		1-	B	a6
R 1020	CHIPRES.	330	1/16W	5%	RMC1/16 331JATP	J24185331		1-	A	D6
R 1020	CHIPRES.	820	1/16W	5%	RMC1/16 821JATP	J24185821		21-	A	D6
R 1021	CHIPRES.	56	1/16W	5%	RMC1/16 560JATP	J24185560		1-	A	D6
R 1022	CHIPRES.	220	1/16W	5%	RMC1/16 221JATP	J24185221		1-	A	D6
R 1022	CHIPRES.	470	1/16W	5%	RMC1/16 471JATP	J24185471		21-	A	D6
R 1023	CHIPRES.	470	1/16W	5%	RMC1/16S 471JTH	J24189021		1-	A	C4
R 1024	CHIPRES.	470	1/16W	5%	RMC1/16S 471JTH	J24189021		1-	A	C4
R 1025	CHIPRES.	10k	1/16W	5%	RMC1/16S 103JTH	J24189037		1-	B	a6
R 1026	CHIPRES.	47k	1/16W	5%	RMC1/16S 473JTH	J24189045		1-	B	a6
R 1027	CHIPRES.	2.2M	1/16W	5%	RMC1/16S 225JTH	J24189065		1-	B	a6
R 1028	CHIPRES.	100k	1/16W	5%	RMC1/16S 104JTH	J24189049		1-	B	a6
R 1029	CHIPRES.	68k	1/16W	5%	RMC1/16S 683JTH	J24189047		1-85	B	a6
R 1031	CHIPRES.	470	1/2W	5%	RMC1/2 471JCTP	J24275471		1-	B	b6
R 1032	CHIPRES.	4.7k	1/16W	5%	RMC1/16S 472JTH	J24189033		1-	B	a6
R 1033	CHIPRES.	220	1/4W	5%	RMC1/4 221JATP	J24245221		1-	B	b6
R 1034	CHIPRES.	100k	1/16W	5%	RMC1/16S 104JTH	J24189049		1-	B	a6
R 1035	CHIPRES.	3.3k	1/16W	5%	RMC1/16S 332JTH	J24189031		1-	A	E5
R 1035	CHIPRES.	2.7k	1/16W	5%	RMC1/16S 272JTH	J24189030		10-	A	E5
R 1035	CHIPRES.	1.5k	1/16W	5%	RMC1/16S 152JTH	J24189027		21-	A	E5
R 1036	CHIPRES.	10k	1/16W	5%	RMC1/16S 103JTH	J24189037		1-	B	a6
R 1037	CHIPRES.	470	1/16W	5%	RMC1/16S 471JTH	J24189021		1-	A	C4
R 1038	CHIPRES.	10	1/16W	5%	RMC1/16 100JATP	J24185100		1-	A	E6
R 1039	CHIPRES.	10	1/16W	5%	RMC1/16 100JATP	J24185100		1-	A	E6
R 1041	CHIPRES.	56	1/16W	5%	RMC1/16 560JATP	J24185560		1-	A	E6
R 1042	CHIPRES.	1k	1/16W	5%	RMC1/16 102JATP	J24185102		1-	A	E6
R 1043	CHIPRES.	4.7k	1/16W	5%	RMC1/16S 472JTH	J24189033		1-	B	a6
R 1044	CHIPRES.	100k	1/16W	5%	RMC1/16S 104JTH	J24189049		1	B	a6
R 1044	CHIPRES.	2.2M	1/16W	5%	RMC1/16S 225JTH	J24189065		2-	B	a6
R 1045	CHIPRES.	10	1/16W	5%	RMC1/16S 100JTH	J24189001		1-	B	a6
R 1046	CHIPRES.	2.2k	1/16W	5%	RMC1/16S 222JTH	J24189029		1-	B	a6
R 1047	CHIPRES.	10k	1/16W	5%	RMC1/16S 103JTH	J24189037		1-14	B	a6
R 1048	CHIPRES.	270	1/16W	5%	RMC1/16 271JATP	J24185271		1-	B	b5
R 1048	CHIPRES.	68	1/16W	5%	RMC1/16 680JATP	J24185680		86-	B	b5
R 1049	CHIPRES.	100	1/16W	5%	RMC1/16S 101JTH	J24189013		1-	B	a6
R 1049	CHIPRES.	330	1/16W	5%	RMC1/16S 331JTH	J24189019		3-	B	a6
R 1049	CHIPRES.	3.3k	1/16W	5%	RMC1/16S 332JTH	J24189031		14-	B	a6
R 1050	CHIPRES.	470	1/10W	5%	RMC1/10T 471J	J24205471		1-	B	b6
R 1051	CHIPRES.	470k	1/16W	5%	RMC1/16S 474JTH	J24189057		1-	B	a6
R 1052	CHIPRES.	4.7k	1/16W	5%	RMC1/16S 472JTH	J24189033		1-	A	E5
R 1052	CHIPRES.	1.8k	1/16W	5%	RMC1/16S 182JTH	J24189028		3-	A	E5
R 1052	CHIPRES.	1.2k	1/16W	5%	RMC1/16S 122JTH	J24189026		19-	A	E5
R 1053	CHIPRES.	100	1/16W	5%	RMC1/16 101JATP	J24185101		1-	A	D5
R 1054	CHIPRES.	1k	1/16W	5%	RMC1/16 102JATP	J24185102		1-	B	b6
R 1054	CHIPRES.	470	1/16W	5%	RMC1/16 471JATP	J24185471		3-	B	b6
R 1054	CHIPRES.	330	1/16W	5%	RMC1/16 331JATP	J24185331		19-	B	b6



# MAIN Unit

## Parts List

REF	DESCRIPTION	VALUE	V/W	TOL.	MFR'S DESIG	VXSTD P/N	VERS.	LOT	SIDE	LAYADR
R 1057	CHIPRES.	3.3k	1/16W	5%	RMC1/16S 332JTH	J24189031		1-	A	E5
R 1058	CHIPRES.	10k	1/16W	5%	RMC1/16S 103JTH	J24189037		1-	B	a6
R 1059	CHIPRES.	47k	1/16W	5%	RMC1/16S 473JTH	J24189045		1-	B	a6
R 1060	CHIPRES.	3.3k	1/16W	5%	RMC1/16S 332JTH	J24189031		1-	B	a6
R 1061	CHIPRES.	100	1/16W	5%	RMC1/16 101JATP	J24185101		1-	A	E5
R 1062	CHIPRES.	56	1/16W	5%	RMC1/16 560JATP	J24185560		1-	B	a5
R 1062	CHIPRES.	100	1/16W	5%	RMC1/16 101JATP	J24185101		38-	B	a5
R 1063	CHIPRES.	10k	1/16W	5%	RMC1/16S 103JTH	J24189037		1-	B	a6
R 1064	CHIPRES.	390	1/16W	5%	RMC1/16S 391JTH	J24189020		1-	A	C4
R 1065	CHIPRES.	100	1/16W	5%	RMC1/16 101JATP	J24185101		1-	B	b5
R 1066	CHIPRES.	4.7k	1/16W	5%	RMC1/16S 472JTH	J24189033		1-	A	C4
R 1066	CHIPRES.	1k	1/16W	5%	RMC1/16S 102JTH	J24189025		25-	A	C4
R 1067	CHIPRES.	47k	1/16W	5%	RMC1/16S 473JTH	J24189045		1-	B	a6
R 1068	CHIPRES.	470	1/16W	5%	RMC1/16S 471JTH	J24189021		1-	A	C4
R 1069	CHIPRES.	10k	1/16W	5%	RMC1/16S 103JTH	J24189037		1-	B	a6
R 1070	CHIPRES.	0	1/16W	5%	RMC1/16 000JATP	J24185000		1-	A	E5
R 1070	CHIPRES.	2.2k	1/16W	5%	RMC1/16 222JATP	J24185222		14-	A	E5
R 1071	CHIPRES.	1.8k	1/16W	5%	RMC1/16 182JATP	J24185182		1-	B	b5
R 1072	CHIPRES.	1.8k	1/16W	5%	RMC1/16 182JATP	J24185182		1-	B	b5
R 1073	CHIPRES.	10k	1/16W	5%	RMC1/16S 103JTH	J24189037		1-	B	a6
R 1074	CHIPRES.	470	1/16W	5%	RMC1/16S 471JTH	J24189021		1-	A	C4
R 1075	CHIPRES.	1k	1/16W	5%	RMC1/16S 102JTH	J24189025		1-	A	E5
R 1076	CHIPRES.	10k	1/16W	5%	RMC1/16S 103JTH	J24189037		1-	A	C4
R 1077	CHIPRES.	470	1/16W	5%	RMC1/16S 471JTH	J24189021		1-	A	C4
R 1078	CHIPRES.	10k	1/16W	5%	RMC1/16S 103JTH	J24189037		1-	A	E4
R 1079	CHIPRES.	220k	1/16W	5%	RMC1/16S 224JTH	J24189053		1-	B	a6
R 1080	CHIPRES.	120	1/16W	5%	RMC1/16 121JATP	J24185121		1-	B	a5
R 1080	CHIPRES.	82	1/16W	5%	RMC1/16 820JATP	J24185820		86-	B	a5
R 1082	CHIPRES.	100k	1/16W	5%	RMC1/16S 104JTH	J24189049		1-	B	c4
R 1083	CHIPRES.	2.2k	1/16W	5%	RMC1/16S 222JTH	J24189029		1-	B	c4
R 1084	CHIPRES.	47k	1/16W	5%	RMC1/16S 473JTH	J24189045		1-	B	a6
R 1085	CHIPRES.	470	1/16W	5%	RMC1/16S 471JTH	J24189021		1-	B	c4
R 1086	CHIPRES.	1k	1/16W	5%	RMC1/16S 102JTH	J24189025		1-	A	D4
R 1087	CHIPRES.	1k	1/16W	5%	RMC1/16S 102JTH	J24189025		1-	A	C4
R 1088	CHIPRES.	56	1/16W	5%	RMC1/16 560JATP	J24185560		1-	B	a5
R 1088	CHIPRES.	100	1/16W	5%	RMC1/16 101JATP	J24185101		86-	B	a5
R 1089	CHIPRES.	1k	1/16W	5%	RMC1/16S 102JTH	J24189025		1-	B	c4
R 1090	CHIPRES.	330	1/16W	5%	RMC1/16 331JATP	J24185331		1-	B	a5
R 1091	CHIPRES.	0	1/16W	5%	RMC1/16S JPTH	J24189070		1-	B	a6
R 1092	CHIPRES.	1k	1/16W	5%	RMC1/16S 102JTH	J24189025		1-	B	c4
R 1093	CHIPRES.	22k	1/16W	5%	RMC1/16S 223JTH	J24189041		1-	B	a6
R 1094	CHIPRES.	10k	1/16W	5%	RMC1/16S 103JTH	J24189037		1-	A	B4
R 1095	CHIPRES.	120	1/16W	5%	RMC1/16 121JATP	J24185121		1-	B	a5
R 1095	CHIPRES.	82	1/16W	5%	RMC1/16 820JATP	J24185820		86-	B	a5
R 1096	CHIPRES.	10	1/16W	5%	RMC1/16S 100JTH	J24189001		1-	A	C4
R 1097	CARBON FILM RES.	27k	1/6W	5%	RD16PJ273 27K	J01225273		1-	A	B4
R 1097	CHIPRES.	27k	1/16W	5%	RMC1/16S 273JTH	J24189042		4-	A	B4
R 1098	CHIPRES.	470	1/16W	5%	RMC1/16S 471JTH	J24189021		1-	B	b4
R 1098	CHIPRES.	100	1/16W	5%	RMC1/16S 101JTH	J24189013		67-	B	b4
R 1099	CHIPRES.	470k	1/16W	5%	RMC1/16S 474JTH	J24189057		1-	B	b4
R 1100	CHIPRES.	470k	1/16W	5%	RMC1/16S 474JTH	J24189057		1-	B	c5
R 1101	CHIPRES.	27	1/16W	5%	RMC1/16S 270JTH	J24189006		1-	B	c4
R 1103	CHIPRES.	120	1/16W	5%	RMC1/16S 121JTH	J24189014		1-	A	E5
R 1104	CHIPRES.	680k	1/16W	5%	RMC1/16S 684JTH	J24189059		1-	B	b4
R 1105	CHIPRES.	680k	1/16W	5%	RMC1/16S 684JTH	J24189059		1-	B	c5
R 1106	CHIPRES.	100k	1/16W	5%	RMC1/16S 104JTH	J24189049		1-	B	b4
R 1107	CHIPRES.	100k	1/16W	5%	RMC1/16S 104JTH	J24189049		1-	B	c5
R 1108	CHIPRES.	33	1/16W	5%	RMC1/16S 330JTH	J24189007		1-	B	c4
R 1109	CHIPRES.	27	1/16W	5%	RMC1/16S 270JTH	J24189006		1-	B	c4
R 1110	CHIPRES.	1k	1/16W	5%	RMC1/16S 102JTH	J24189025		1-	A	E5
R 1111	CHIPRES.	68	1/16W	5%	RMC1/16S 680JTH	J24189011		1-	B	c4
R 1112	CHIPRES.	100k	1/16W	5%	RMC1/16S 104JTH	J24189049		1-	B	b4
R 1113	CHIPRES.	100k	1/16W	5%	RMC1/16S 104JTH	J24189049		1-	B	b5
R 1114	CHIPRES.	18	1/16W	5%	RMC1/16S 180JTH	J24189004		1-	B	a5
R 1114	CHIPRES.	10	1/16W	5%	RMC1/16S 100JTH	J24189001		86-	B	a5
R 1115	CHIPRES.	470	1/16W	5%	RMC1/16S 471JTH	J24189021		1-	B	c4
R 1116	CHIPRES.	33	1/16W	5%	RMC1/16S 330JTH	J24189007		1-	B	c4
R 1117	CHIPRES.	68	1/16W	5%	RMC1/16S 680JTH	J24189011		1-	A	E5
R 1117	CHIPRES.	120	1/16W	5%	RMC1/16S 121JTH	J24189014		86-	A	E5
R 1118	CHIPRES.	68	1/16W	5%	RMC1/16S 680JTH	J24189011		1-	B	c4
R 1118	CHIPRES.	27	1/16W	5%	RMC1/16S 270JTH	J24189006		103-	B	c4
R 1119	CHIPRES.	470	1/16W	5%	RMC1/16S 471JTH	J24189021		1-	B	c4
R 1120	CHIPRES.	470k	1/16W	5%	RMC1/16S 474JTH	J24189057		1-	B	b4

# MAIN Unit

## Parts List

REF	DESCRIPTION	VALUE	V/W	TOL.	MFR'S DESIG	VXSTD P/N	VERS.	LOT	SIDE	LAYADR
R 1121	CHIPRES.	470k	1/16W	5%	RMC1/16S 474JTH	J24189057		1-	B	b4
R 1122	CHIPRES.	18	1/16W	5%	RMC1/16S 180JTH	J24189004		1-	B	a5
R 1122	CHIPRES.	10	1/16W	5%	RMC1/16S 100JTH	J24189001		86-	B	a5
R 1123	CHIPRES.	33	1/16W	5%	RMC1/16S 330JTH	J24189007		1-	B	c4
R 1124	CHIPRES.	15k	1/16W	5%	RMC1/16S 153JTH	J24189039		1-	B	b4
R 1124	CHIPRES.	10k	1/16W	5%	RMC1/16S 103JTH	J24189037		9-	B	b4
R 1125	CHIPRES.	4.7k	1/16W	5%	RMC1/16S 472JTH	J24189033		1-	B	c4
R 1126	CHIPRES.	1k	1/16W	5%	RMC1/16S 102JTH	J24189025		1-	A	D4
R 1127	CHIPRES.	10	1/16W	5%	RMC1/16S 100JTH	J24189001		1-	A	D4
R 1128	CHIPRES.	10	1/16W	5%	RMC1/16S 100JTH	J24189001		1-	A	D4
R 1129	CHIPRES.	100	1/16W	5%	RMC1/16S 101JTH	J24189013		1-	B	c4
R 1130	CHIPRES.	470	1/16W	5%	RMC1/16S 471JTH	J24189021		1-76	B	c4
R 1131	CHIPRES.	33	1/16W	5%	RMC1/16S 330JTH	J24189007		1-	A	C4
R 1132	CHIPRES.	10	1/16W	5%	RMC1/16S 100JTH	J24189001		1-	B	a4
R 1132	CHIPRES.	27	1/16W	5%	RMC1/16S 270JTH	J24189006		50-	B	a4
R 1132	CHIPRES.	22	1/16W	5%	RMC1/16S 220JTH	J24189005		86-	B	a4
R 1133	CHIPRES.	470k	1/16W	5%	RMC1/16S 474JTH	J24189057		1-	B	b5
R 1134	CHIPRES.	100	1/16W	5%	RMC1/16S 101JTH	J24189013		1-	A	F4
R 1135	CHIPRES.	150	1/16W	5%	RMC1/16S 151JTH	J24189015		1-	B	a4
R 1135	CHIPRES.	27	1/16W	5%	RMC1/16S 270JTH	J24189006		50-	B	a4
R 1135	CHIPRES.	56	1/16W	5%	RMC1/16S 560JTH	J24189010		86-	B	a4
R 1136	CHIPRES.	1k	1/16W	5%	RMC1/16S 102JTH	J24189025		1-	B	a4
R 1137	CHIPRES.	1k	1/16W	5%	RMC1/16S 102JTH	J24189025		1-	A	D4
R 1138	CHIPRES.	1k	1/16W	5%	RMC1/16S 102JTH	J24189025		1-	A	E5
R 1139	CHIPRES.	1M	1/16W	5%	RMC1/16S 105JTH	J24189061		1-	A	F4
R 1140	CHIPRES.	15k	1/16W	5%	RMC1/16S 153JTH	J24189039		1-8	B	e5
R 1141	CHIPRES.	22k	1/16W	5%	RMC1/16S 223JTH	J24189041		9-	B	e5
R 1142	CHIPRES.	10	1/16W	5%	RMC1/16S 100JTH	J24189001		1-	B	a4
R 1142	CHIPRES.	27	1/16W	5%	RMC1/16S 270JTH	J24189006		50-	B	a4
R 1142	CHIPRES.	22	1/16W	5%	RMC1/16S 220JTH	J24189005		86-	B	a4
R 1143	CHIPRES.	470	1/16W	5%	RMC1/16S 471JTH	J24189021		1-	A	E4
R 1144	CHIPRES.	1k	1/16W	5%	RMC1/16S 102JTH	J24189025		1-	B	b4
R 1145	CHIPRES.	1k	1/16W	5%	RMC1/16S 102JTH	J24189025		1-	B	b5
R 1146	CHIPRES.	100k	1/16W	5%	RMC1/16S 104JTH	J24189049		1-	A	E4
R 1147	CHIPRES.	100	1/16W	5%	RMC1/16S 101JTH	J24189013		1-	B	a4
R 1148	CHIPRES.	1k	1/16W	5%	RMC1/16S 102JTH	J24189025		1-	B	b4
R 1149	CHIPRES.	100k	1/16W	5%	RMC1/16S 104JTH	J24189049		1-	A	E4
R 1150	CHIPRES.	33k	1/16W	5%	RMC1/16S 333JTH	J24189043		1-	B	e5
R 1151	CHIPRES.	470	1/16W	5%	RMC1/16S 471JTH	J24189021		1-	A	E3
R 1153	CARBON FILM RES.	10k	1/6W	5%	RD16PJ103 10K	J01225103		1-	B	b4
R 1153	CHIPRES.	10k	1/16W	5%	RMC1/16S 103JTH	J24189037		4-	B	b4
R 1154	CHIPRES.	1M	1/16W	5%	RMC1/16S 105JTH	J24189061		1-	A	F4
R 1155	CHIPRES.	100k	1/16W	5%	RMC1/16S 104JTH	J24189049		1-	A	E4
R 1156	CHIPRES.	82k	1/16W	5%	RMC1/16S 823JTH	J24189048		1-	B	e5
R 1157	CHIPRES.	47k	1/16W	5%	RMC1/16S 473JTH	J24189045		1-	B	e5
R 1158	CHIPRES.	1k	1/16W	5%	RMC1/16S 102JTH	J24189025		1-	B	a3
R 1159	CHIPRES.	4.7k	1/16W	5%	RMC1/16S 472JTH	J24189033		1-	B	e5
R 1160	CHIPRES.	100k	1/16W	5%	RMC1/16S 104JTH	J24189049		1-	B	e5
R 1161	CHIPRES.	100	1/16W	5%	RMC1/16S 101JTH	J24189013		1-	A	F3
R 1162	CHIPRES.	4.7k	1/16W	5%	RMC1/16S 472JTH	J24189033		1-	B	e5
R 1163	CHIPRES.	10k	1/16W	5%	RMC1/16S 103JTH	J24189037		1-	A	A5
R 1164	CHIPRES.	1k	1/16W	5%	RMC1/16S 102JTH	J24189025		1-	A	E3
R 1165	CHIPRES.	3.3k	1/16W	5%	RMC1/16S 332JTH	J24189031		1-16	A	A5
R 1166	CHIPRES.	47k	1/16W	5%	RMC1/16S 473JTH	J24189045		1-	A	A5
R 1167	CHIPRES.	47k	1/16W	5%	RMC1/16S 473JTH	J24189045		1-	A	A5
R 1168	CHIPRES.	47k	1/16W	5%	RMC1/16S 473JTH	J24189045		1-	A	B4
R 1169	CHIPRES.	100k	1/16W	5%	RMC1/16S 104JTH	J24189049		1-	A	B4
R 1170	CHIPRES.	10k	1/16W	5%	RMC1/16S 103JTH	J24189037		1-26	A	A5
R 1171	CHIPRES.	100k	1/16W	5%	RMC1/16S 104JTH	J24189049		1-	A	A5
R 1172	CHIPRES.	1k	1/16W	5%	RMC1/16S 102JTH	J24189025		1-	B	a3
R 1173	CHIPRES.	100k	1/16W	5%	RMC1/16S 104JTH	J24189049		1-	B	e5
R 1174	CHIPRES.	470	1/16W	5%	RMC1/16S 471JTH	J24189021		1-	A	F3
R 1175	CHIPRES.	100k	1/16W	5%	RMC1/16S 104JTH	J24189049		1-	B	e5
R 1175	CHIPRES.	220k	1/16W	5%	RMC1/16S 224JTH	J24189053		17-	B	e5
R 1176	CHIPRES.	100	1/16W	5%	RMC1/16S 101JTH	J24189013		1-	B	a3
R 1177	CHIPRES.	100k	1/16W	5%	RMC1/16S 104JTH	J24189049		1-	B	e5
R 1178	CHIPRES.	47k	1/16W	5%	RMC1/16S 473JTH	J24189045		1-	B	e5
R 1179	CHIPRES.	22k	1/16W	5%	RMC1/16S 223JTH	J24189041		1-	B	b2
R 1181	CHIPRES.	22k	1/16W	5%	RMC1/16S 223JTH	J24189041		1-	B	b2
R 1183	CHIPRES.	22k	1/16W	5%	RMC1/16S 223JTH	J24189041		1-	B	a2
R 1184	CHIPRES.	10k	1/16W	5%	RMC1/16S 103JTH	J24189037		1-	B	e5
R 1185	CHIPRES.	22k	1/16W	5%	RMC1/16S 223JTH	J24189041		1-	B	a2
R 1186	CHIPRES.	1k	1/16W	5%	RMC1/16S 102JTH	J24189025		1-	A	D3

# MAIN Unit

## Parts List

REF	DESCRIPTION	VALUE	V/W	TOL.	MFR'S DESIG	VXSTD P/N	VERS.	LOT	SIDE	LAYADR
R 1187	CHIPRES.	10k	1/16W	5%	RMC1/16S 103JTH	J24189037		1-	A	D2
R 1188	CHIPRES.	10k	1/16W	5%	RMC1/16S 103JTH	J24189037		1-	B	a1
R 1189	CHIPRES.	100	1/16W	5%	RMC1/16S 101JTH	J24189013		1-	B	a3
R 1190	CHIPRES.	1k	1/16W	5%	RMC1/16S 102JTH	J24189025		1-	A	D2
R 1191	CHIPRES.	1k	1/16W	5%	RMC1/16S 102JTH	J24189025		1-	A	E5
R 1192	CHIPRES.	1k	1/16W	5%	RMC1/16S 102JTH	J24189025		1-	B	a3
R 1193	CHIPRES.	100k	1/16W	5%	RMC1/16S 104JTH	J24189049		1-	B	b2
R 1194	CHIPRES.	120k	1/16W	5%	RMC1/16S 124JTH	J24189050		1-	A	B4
R 1195	CHIPRES.	10k	1/16W	5%	RMC1/16S 103JTH	J24189037		1-	B	b2
R 1196	CHIPRES.	1k	1/16W	5%	RMC1/16S 102JTH	J24189025		1-	B	c2
R 1197	CHIPRES.	330k	1/16W	5%	RMC1/16S 334JTH	J24189055		1-	B	a1
R 1198	CHIPRES.	150k	1/16W	5%	RMC1/16S 154JTH	J24189051		1-	A	B4
R 1199	CHIPRES.	1k	1/16W	5%	RMC1/16S 102JTH	J24189025		1-	B	b2
R 1200	CHIPRES.	4.7k	1/16W	5%	RMC1/16S 472JTH	J24189033		1-	B	a1
R 1201	CHIPRES.	100	1/16W	5%	RMC1/16S 101JTH	J24189013		1-	B	a1
R 1202	CHIPRES.	4.7k	1/16W	5%	RMC1/16S 472JTH	J24189033		1-	B	a1
R 1203	CHIPRES.	3.3k	1/16W	5%	RMC1/16S 332JTH	J24189031		1-	B	c3
R 1204	CHIPRES.	100k	1/16W	5%	RMC1/16S 104JTH	J24189049		1-	B	c3
R 1205	CHIPRES.	470	1/16W	5%	RMC1/16S 471JTH	J24189021		1-	A	D4
R 1206	CHIPRES.	330k	1/16W	5%	RMC1/16S 334JTH	J24189055		1-	B	a1
R 1207	CHIPRES.	2.2k	1/16W	5%	RMC1/16S 222JTH	J24189029		1-	B	a1
R 1208	CHIPRES.	47k	1/16W	5%	RMC1/16S 473JTH	J24189045		1-	B	c3
R 1209	CHIPRES.	1k	1/16W	5%	RMC1/16S 102JTH	J24189025		1-	B	a3
R 1210	CHIPRES.	10k	1/16W	5%	RMC1/16S 103JTH	J24189037		1-	B	b3
R 1211	CHIPRES.	100	1/16W	5%	RMC1/16S 101JTH	J24189013		1-	A	B5
R 1211	CHIPRES.	0	1/16W	5%	RMC1/16S JPTH	J24189070		61-	A	B5
R 1212	CHIPRES.	470k	1/16W	5%	RMC1/16S 474JTH	J24189057		1-	A	E4
R 1213	CHIPRES.	2.2k	1/16W	5%	RMC1/16S 222JTH	J24189029		1-	B	b4
R 1214	CHIPRES.	100k	1/16W	5%	RMC1/16S 104JTH	J24189049		1-	B	b2
R 1215	CHIPRES.	100	1/16W	5%	RMC1/16S 101JTH	J24189013		1-	B	a1
R 1216	CHIPRES.	100k	1/16W	5%	RMC1/16S 104JTH	J24189049		1-	B	c3
R 1217	CHIPRES.	1k	1/16W	5%	RMC1/16S 102JTH	J24189025		1-	B	b2
R 1218	CHIPRES.	100k	1/16W	5%	RMC1/16S 104JTH	J24189049		1-	A	B5
R 1219	CHIPRES.	0	1/16W	5%	RMC1/16 000JATP	J24185000		1-	A	B5
R 1220	CHIPRES.	220k	1/16W	5%	RMC1/16S 224JTH	J24189053		1-	B	b2
R 1221	CHIPRES.	100k	1/16W	5%	RMC1/16S 104JTH	J24189049		1-	A	B4
R 1222	CHIPRES.	47	1/16W	5%	RMC1/16S 470JTH	J24189009		1-	B	b2
R 1223	CHIPRES.	1k	1/16W	5%	RMC1/16S 102JTH	J24189025		1-	B	b2
R 1224	CHIPRES.	2.2k	1/16W	5%	RMC1/16S 222JTH	J24189029		1-	B	b3
R 1225	CHIPRES.	100k	1/16W	5%	RMC1/16S 104JTH	J24189049		1-	A	B4
R 1226	CHIPRES.	10k	1/16W	5%	RMC1/16S 103JTH	J24189037		1-	B	a4
R 1228	CHIPRES.	1k	1/16W	5%	RMC1/16S 102JTH	J24189025		1-	B	b2
R 1229	CHIPRES.	150	1/16W	5%	RMC1/16S 151JTH	J24189015		1-	A	D4
R 1230	CHIPRES.	150	1/16W	5%	RMC1/16S 151JTH	J24189015		1-	A	E4
R 1231	CHIPRES.	10k	1/16W	5%	RMC1/16S 103JTH	J24189037		1-	A	D2
R 1232	CHIPRES.	100	1/16W	5%	RMC1/16S 101JTH	J24189013		1-	B	b3
R 1232	CHIPRES.	100	1/16W	5%	RMC1/16S 101JTH	J24189013		38-49	B	b3
R 1233	CHIPRES.	33k	1/16W	5%	RMC1/16S 333JTH	J24189043		1-	B	b2
R 1234	CHIPRES.	10k	1/16W	5%	RMC1/16S 103JTH	J24189037		1-	A	D2
R 1235	CHIPRES.	100	1/16W	5%	RMC1/16S 101JTH	J24189013		1-	B	b5
R 1236	CHIPRES.	22k	1/16W	5%	RMC1/16S 223JTH	J24189041		1-	A	D2
R 1237	CHIPRES.	47k	1/16W	5%	RMC1/16S 473JTH	J24189045		1-	B	a5
R 1238	CHIPRES.	10k	1/16W	5%	RMC1/16S 103JTH	J24189037		1-	B	a4
R 1239	CHIPRES.	10	1/16W	5%	RMC1/16S 100JTH	J24189001		1-	A	D3
R 1239	CHIPRES.	150	1/16W	5%	RMC1/16S 151JTH	J24189015		25-	A	D3
R 1240	CHIPRES.	4.7k	1/16W	5%	RMC1/16S 472JTH	J24189033		1-	A	D2
R 1241	CHIPRES.	22	1/16W	5%	RMC1/16S 220JTH	J24189005		1-	B	a1
R 1242	CHIPRES.	10k	1/16W	5%	RMC1/16S 103JTH	J24189037		1-	B	b4
R 1243	CHIPRES.	100k	1/16W	5%	RMC1/16S 104JTH	J24189049		1-	B	a1
R 1244	CHIPRES.	56k	1/16W	5%	RMC1/16S 563JTH	J24189046		1-	A	D2
R 1245	CHIPRES.	100	1/16W	5%	RMC1/16S 101JTH	J24189013		1-	B	b3
R 1245	CHIPRES.	100k	1/16W	5%	RMC1/16S 104JTH	J24189049		15-	B	b3
R 1246	CHIPRES.	2.2k	1/16W	5%	RMC1/16S 222JTH	J24189029		1-	B	a1
R 1247	CHIPRES.	120k	1/16W	5%	RMC1/16S 124JTH	J24189050		1	A	D2
R 1247	CHIPRES.	82k	1/16W	5%	RMC1/16S 823JTH	J24189048		2-	A	D2
R 1248	CHIPRES.	470k	1/16W	5%	RMC1/16S 474JTH	J24189057		1-	B	b3
R 1248	CHIPRES.	330k	1/16W	5%	RMC1/16S 334JTH	J24189055		15-	B	b3
R 1248	CHIPRES.	150k	1/16W	5%	RMC1/16S 154JTH	J24189051		25-	B	b3
R 1249	CHIPRES.	3.9k	1/16W	5%	RMC1/16S 392JTH	J24189032		1-	B	a1
R 1250	CHIPRES.	33	1/16W	5%	RMC1/16S 330JTH	J24189007		1-	A	D4
R 1251	CHIPRES.	220k	1/16W	5%	RMC1/16S 224JTH	J24189053		25-	B	b3
R 1252	CHIPRES.	100k	1/16W	5%	RMC1/16S 104JTH	J24189049		1-	A	D2
R 1253	CHIPRES.	10k	1/16W	5%	RMC1/16S 103JTH	J24189037		1-	A	A5

# MAIN Unit

## Parts List

REF	DESCRIPTION	VALUE	V/W	TOL.	MFR'S DESIG	VXSTD P/N	VERS.	LOT	SIDE	LAYADR
R 1254	CHIPRES.	22k	1/16W	5%	RMC1/16S 223JTH	J24189041		1-	A	D2
R 1255	CHIPRES.	68	1/16W	5%	RMC1/16S 680JTH	J24189011		1-	B	b1
R 1256	CHIPRES.	2.2k	1/16W	5%	RMC1/16S 222JTH	J24189029		1-	A	B4
R 1257	CHIPRES.	3.3k	1/16W	5%	RMC1/16S 332JTH	J24189031		1-	A	D4
R 1258	CHIPRES.	4.7k	1/16W	5%	RMC1/16S 472JTH	J24189033		1-	A	D4
R 1259	CHIPRES.	470	1/16W	5%	RMC1/16S 471JTH	J24189021		1-	B	b1
R 1260	CHIPRES.	1k	1/16W	5%	RMC1/16S 102JTH	J24189025		1-	A	D3
R 1261	CHIP CAP.	0.001uF	50V	B	UMK105B102KW-F	K22178829	W/ CE LABEL	4-24		
R 1262	CHIPRES.	4.7k	1/16W	5%	RMC1/16S 472JTH	J24189033		1-	A	C5
R 1263	CHIPRES.	4.7k	1/16W	5%	RMC1/16S 472JTH	J24189033		1-	A	C5
R 1264	CHIPRES.	470	1/16W	5%	RMC1/16S 471JTH	J24189021		1-	B	a1
R 1265	CHIPRES.	1k	1/16W	5%	RMC1/16S 102JTH	J24189025		1-	A	D4
R 1266	CHIPRES.	2.2k	1/16W	5%	RMC1/16S 222JTH	J24189029		1-	A	B4
R 1267	CHIPRES.	470	1/16W	5%	RMC1/16S 471JTH	J24189021		1-	B	b1
R 1268	CHIPRES.	1.5k	1/16W	5%	RMC1/16S 152JTH	J24189027		1-	B	b3
R 1270	CHIPRES.	1k	1/16W	5%	RMC1/16S 102JTH	J24189025		1-	B	a3
R 1272	CHIPRES.	100	1/16W	5%	RMC1/16S 101JTH	J24189013		1-	B	a3
R 1273	CHIPRES.	1k	1/16W	5%	RMC1/16S 102JTH	J24189025		1-	A	D3
R 1274	CHIPRES.	100k	1/16W	5%	RMC1/16S 104JTH	J24189049		1-	A	C1
R 1275	CHIPRES.	100k	1/16W	5%	RMC1/16S 104JTH	J24189049		1-	A	C1
R 1276	CHIPRES.	100k	1/16W	5%	RMC1/16S 104JTH	J24189049		1-	A	D1
R 1277	CHIPRES.	10k	1/16W	5%	RMC1/16S 103JTH	J24189037		1-	A	B4
R 1278	CHIPRES.	1k	1/16W	5%	RMC1/16S 102JTH	J24189025		1-	A	D3
R 1280	CHIPRES.	100k	1/16W	5%	RMC1/16S 104JTH	J24189049		1-	B	c2
R 1281	CHIPRES.	100	1/16W	5%	RMC1/16S 101JTH	J24189013		1-	A	C2
R 1282	CHIPRES.	47k	1/16W	5%	RMC1/16S 473JTH	J24189045		1-	B	c2
R 1283	CHIPRES.	22k	1/16W	5%	RMC1/16S 223JTH	J24189041		1-	A	B4
R 1284	CHIPRES.	4.7k	1/16W	5%	RMC1/16S 472JTH	J24189033		1-	A	C1
R 1285	CHIPRES.	100	1/16W	5%	RMC1/16S 101JTH	J24189013		1-	A	C1
R 1286	CHIPRES.	68k	1/16W	5%	RMC1/16S 683JTH	J24189047		1-	B	c1
R 1287	CHIPRES.	470k	1/16W	5%	RMC1/16S 474JTH	J24189057		1-	A	C2
R 1288	CHIPRES.	22k	1/16W	5%	RMC1/16S 223JTH	J24189041		1-	B	d1
R 1289	CHIPRES.	15k	1/16W	5%	RMC1/16S 153JTH	J24189039		1	A	C2
R 1289	CHIPRES.	22k	1/16W	5%	RMC1/16S 223JTH	J24189041		2-	A	C2
R 1289	CHIPRES.	15k	1/16W	5%	RMC1/16S 153JTH	J24189039		38-	A	C2
R 1290	CHIPRES.	100k	1/16W	5%	RMC1/16S 104JTH	J24189049		1-	A	C2
R 1290	CHIPRES.	22k	1/16W	5%	RMC1/16S 223JTH	J24189041		25-	A	C2
R 1291	CHIPRES.	100k	1/16W	5%	RMC1/16S 104JTH	J24189049		1-	A	D2
R 1291	CHIPRES.	22k	1/16W	5%	RMC1/16S 223JTH	J24189041		25-	A	D2
R 1292	CHIPRES.	220k	1/16W	5%	RMC1/16S 224JTH	J24189053		1-	A	D2
R 1293	CHIPRES.	1k	1/16W	5%	RMC1/16S 102JTH	J24189025		1-	A	C1
R 1294	CHIPRES.	10k	1/16W	5%	RMC1/16S 103JTH	J24189037		1-	A	D1
R 1294	CHIPRES.	39k	1/16W	5%	RMC1/16S 393JTH	J24189044		5-	A	D1
R 1295	CHIPRES.	22k	1/16W	5%	RMC1/16S 223JTH	J24189041		1-	A	B4
R 1296	CHIPRES.	3.3k	1/16W	5%	RMC1/16S 332JTH	J24189031		1-	B	c3
R 1297	CHIPRES.	47k	1/16W	5%	RMC1/16S 473JTH	J24189045		1-	A	D2
R 1298	CHIPRES.	470k	1/16W	5%	RMC1/16S 474JTH	J24189057		1-	A	C1
R 1299	CHIPRES.	22k	1/16W	5%	RMC1/16S 223JTH	J24189041		1-	A	B1
R 1300	CHIPRES.	4.7k	1/16W	5%	RMC1/16S 472JTH	J24189033		1-	B	c3
R 1301	CHIPRES.	6.8k	1/16W	5%	RMC1/16S 682JTH	J24189035		1-	B	d1
R 1302	CHIPRES.	1k	1/16W	5%	RMC1/16S 102JTH	J24189025		1-	A	D3
R 1303	CHIPRES.	10k	1/16W	5%	RMC1/16S 103JTH	J24189037		1-	B	d1
R 1304	CHIPRES.	100k	1/16W	5%	RMC1/16S 104JTH	J24189049		1-	B	c1
R 1305	CHIPRES.	10k	1/16W	5%	RMC1/16S 103JTH	J24189037		1-	A	B3
R 1306	CHIPRES.	680	1/16W	5%	RMC1/16S 681JTH	J24189023		1-	B	c3
R 1306	CHIPRES.	1k	1/16W	5%	RMC1/16S 102JTH	J24189025		14-	B	c3
R 1306	CHIPRES.	470	1/16W	5%	RMC1/16S 471JTH	J24189021		25-	B	c3
R 1307	CHIPRES.	10k	1/16W	5%	RMC1/16S 103JTH	J24189037		1-	A	D1
R 1308	CHIPRES.	10k	1/16W	5%	RMC1/16S 103JTH	J24189037		1-	B	c2
R 1309	CHIPRES.	1k	1/16W	5%	RMC1/16S 102JTH	J24189025		1-	A	C1
R 1310	CHIPRES.	68k	1/16W	5%	RMC1/16S 683JTH	J24189047		1-	B	d1
R 1311	CHIPRES.	150k	1/16W	5%	RMC1/16S 154JTH	J24189051		1-	B	c2
R 1312	CHIPRES.	150k	1/16W	5%	RMC1/16S 154JTH	J24189051		1	A	D2
R 1312	CHIPRES.	150k	1/16W	5%	RMC1/16S 154JTH	J24189051		2-	A	D2
R 1313	CHIPRES.	22k	1/16W	5%	RMC1/16S 223JTH	J24189041		1-	A	B3
R 1314	CHIPRES.	220k	1/16W	5%	RMC1/16S 224JTH	J24189053		1-	B	c3
R 1314	CHIPRES.	150k	1/16W	5%	RMC1/16S 154JTH	J24189051		25-	B	c3
R 1315	CHIPRES.	100	1/16W	5%	RMC1/16S 101JTH	J24189013		1-	B	d1
R 1316	CHIPRES.	470k	1/16W	5%	RMC1/16S 474JTH	J24189057		1-	A	D1
R 1317	CHIPRES.	10k	1/16W	5%	RMC1/16S 103JTH	J24189037		1-	A	D2
R 1318	CHIPRES.	1M	1/16W	5%	RMC1/16S 105JTH	J24189061		1-	B	c3
R 1319	CHIPRES.	100	1/16W	5%	RMC1/16S 101JTH	J24189013		1-	B	d3
R 1320	CHIPRES.	4.7k	1/16W	5%	RMC1/16S 472JTH	J24189033		1-	B	d1

# MAIN Unit

## Parts List

REF	DESCRIPTION	VALUE	V/W	TOL.	MFR'S DESIG	VXSTD P/N	VERS.	LOT	SIDE	LAYADR
R 1321	CHIPRES.	4.7k	1/16W	5%	RMC1/16S 472JTH	J24189033		1-	B	c2
R 1322	CHIPRES.	220k	1/16W	5%	RMC1/16S 224JTH	J24189053		1-	B	c2
R 1323	CHIPRES.	33k	1/16W	5%	RMC1/16S 333JTH	J24189043		1-	A	D2
R 1324	CHIPRES.	680k	1/16W	5%	RMC1/16S 684JTH	J24189059		1-	B	d1
R 1325	CHIPRES.	3.3k	1/16W	5%	RMC1/16S 332JTH	J24189031		1-	A	C2
R 1326	CHIPRES.	100k	1/16W	5%	RMC1/16S 104JTH	J24189049		1-	B	d3
R 1327	CHIPRES.	100	1/16W	5%	RMC1/16S 101JTH	J24189013		1-	B	c2
R 1328	CHIPRES.	33k	1/16W	5%	RMC1/16S 333JTH	J24189043		1-	A	D2
R 1329	CHIPRES.	1.5k	1/16W	5%	RMC1/16S 152JTH	J24189027		1-	A	C2
R 1330	CHIPRES.	100	1/16W	5%	RMC1/16S 101JTH	J24189013		1-	A	C3
R 1330	CHIPRES.	150	1/16W	5%	RMC1/16S 151JTH	J24189015		25-	A	C3
R 1331	CHIPRES.	10k	1/16W	5%	RMC1/16S 103JTH	J24189037		1-	B	d3
R 1332	CHIPRES.	100	1/16W	5%	RMC1/16S 101JTH	J24189013		1-	A	C2
R 1333	CHIPRES.	4.7k	1/16W	5%	RMC1/16S 472JTH	J24189033		1-	B	c2
R 1334	CHIPRES.	1k	1/16W	5%	RMC1/16S 102JTH	J24189025		1-	B	d2
R 1335	CHIPRES.	10k	1/16W	5%	RMC1/16S 103JTH	J24189037		1-	B	d1
R 1336	CHIPRES.	100	1/16W	5%	RMC1/16S 101JTH	J24189013		1-	B	d3
R 1337	CHIPRES.	4.7k	1/16W	5%	RMC1/16S 472JTH	J24189033		1-	B	c1
R 1338	CHIPRES.	1k	1/16W	5%	RMC1/16S 102JTH	J24189025		1-	B	d1
R 1339	CHIPRES.	3.3k	1/16W	5%	RMC1/16S 332JTH	J24189031		1-	B	d1
R 1340	CHIPRES.	2.2k	1/16W	5%	RMC1/16S 222JTH	J24189029		1-	A	C3
R 1340	CHIPRES.	4.7k	1/16W	5%	RMC1/16S 472JTH	J24189033		81-	A	C3
R 1341	CHIPRES.	100k	1/16W	5%	RMC1/16S 104JTH	J24189049		1-	B	c2
R 1342	CHIPRES.	10k	1/16W	5%	RMC1/16S 103JTH	J24189037		1-	B	d4
R 1343	CHIPRES.	10k	1/16W	5%	RMC1/16S 103JTH	J24189037		1-	B	d4
R 1344	CHIPRES.	470k	1/16W	5%	RMC1/16S 474JTH	J24189057		1-	B	b2
R 1345	CHIPRES.	330k	1/16W	5%	RMC1/16S 334JTH	J24189055		1-	B	d1
R 1346	CHIPRES.	100k	1/16W	5%	RMC1/16S 104JTH	J24189049		1-	A	C3
R 1347	CHIPRES.	3.3k	1/16W	5%	RMC1/16S 332JTH	J24189031		1-	A	D2
R 1348	CHIPRES.	100k	1/16W	5%	RMC1/16S 104JTH	J24189049		1-	B	d3
R 1349	CHIPRES.	1k	1/16W	5%	RMC1/16S 102JTH	J24189025		1-	A	C2
R 1350	CHIPRES.	2.2k	1/16W	5%	RMC1/16S 222JTH	J24189029		1-	B	d1
R 1351	CHIPRES.	4.7k	1/16W	5%	RMC1/16S 472JTH	J24189033		1-	B	d1
R 1352	CHIPRES.	1.5k	1/16W	5%	RMC1/16S 152JTH	J24189027		1-	A	C1
R 1353	CHIPRES.	100	1/16W	5%	RMC1/16S 101JTH	J24189013		1-	B	d2
R 1353	CHIPRES.	150	1/16W	5%	RMC1/16S 151JTH	J24189015		25-	B	d2
R 1354	CHIPRES.	33k	1/16W	5%	RMC1/16S 333JTH	J24189043	AUSTRALIA	1-	B	c1
R 1354	CHIPRES.	33k	1/16W	5%	RMC1/16S 333JTH	J24189043	EXPORT	1-	B	c1
R 1354	CHIPRES.	33k	1/16W	5%	RMC1/16S 333JTH	J24189043	FRANCE	1-	B	c1
R 1354	CHIPRES.	33k	1/16W	5%	RMC1/16S 333JTH	J24189043	USA	1-	B	c1
R 1355	CHIPRES.	22k	1/16W	5%	RMC1/16S 223JTH	J24189041		1-	B	b1
R 1355	CHIPRES.	15k	1/16W	5%	RMC1/16S 153JTH	J24189039		88-	B	b1
R 1356	CHIPRES.	100	1/16W	5%	RMC1/16S 101JTH	J24189013		1-	B	d3
R 1357	CHIPRES.	1k	1/16W	5%	RMC1/16S 102JTH	J24189025		1-	A	C2
R 1358	CHIPRES.	10k	1/16W	5%	RMC1/16S 103JTH	J24189037		1-	B	c2
R 1359	CHIPRES.	47k	1/16W	5%	RMC1/16S 473JTH	J24189045		1-	B	c1
R 1360	CHIPRES.	470k	1/16W	5%	RMC1/16S 474JTH	J24189057		1-	B	b2
R 1361	CHIPRES.	10k	1/16W	5%	RMC1/16S 103JTH	J24189037		1-	B	d4
R 1362	CHIPRES.	10k	1/16W	5%	RMC1/16S 103JTH	J24189037		1-	B	d4
R 1363	CHIPRES.	150k	1/16W	5%	RMC1/16S 154JTH	J24189051		4-	B	d2
R 1363	CHIPRES.	33k	1/16W	5%	RMC1/16S 333JTH	J24189043		25-	B	d2
R 1364	CHIPRES.	100	1/16W	5%	RMC1/16S 101JTH	J24189013		1-	B	d3
R 1365	CHIPRES.	22k	1/16W	5%	RMC1/16S 223JTH	J24189041		1-	B	d3
R 1366	CHIPRES.	470	1/16W	5%	RMC1/16S 471JTH	J24189021		1-	B	b1
R 1367	CHIPRES.	3.3k	1/16W	5%	RMC1/16S 332JTH	J24189031		1-	B	d5
R 1368	CHIPRES.	3.3k	1/16W	5%	RMC1/16S 332JTH	J24189031		1-	B	d5
R 1369	CHIPRES.	4.7k	1/16W	5%	RMC1/16S 472JTH	J24189033		1-	B	d3
R 1370	CHIPRES.	33k	1/16W	5%	RMC1/16S 333JTH	J24189043		1-	B	d5
R 1371	CHIPRES.	3.3k	1/16W	5%	RMC1/16S 332JTH	J24189031		1-	B	d4
R 1372	CHIPRES.	3.3k	1/16W	5%	RMC1/16S 332JTH	J24189031		1-	B	d4
R 1373	CHIPRES.	470	1/16W	5%	RMC1/16S 471JTH	J24189021		1-	B	b1
R 1374	CHIPRES.	68k	1/16W	5%	RMC1/16S 683JTH	J24189047		1-	B	d5
R 1375	CHIPRES.	10k	1/16W	5%	RMC1/16S 103JTH	J24189037		1-	B	d5
R 1376	CHIPRES.	10k	1/16W	5%	RMC1/16S 103JTH	J24189037		1-	B	d5
R 1377	CHIPRES.	470	1/16W	5%	RMC1/16S 471JTH	J24189021		1-	B	b1
R 1379	CHIPRES.	100	1/16W	5%	RMC1/16S 101JTH	J24189013		1-	B	d2
R 1380	CHIPRES.	100	1/16W	5%	RMC1/16S 101JTH	J24189013		1-	A	C1
R 1381	CHIPRES.	470k	1/16W	5%	RMC1/16S 474JTH	J24189057		1-	B	b1
R 1382	CHIPRES.	10k	1/16W	5%	RMC1/16S 103JTH	J24189037		1-	B	d5
R 1383	CHIPRES.	10k	1/16W	5%	RMC1/16S 103JTH	J24189037		1-	B	d5
R 1384	CHIPRES.	5.6k	1/16W	5%	RMC1/16S 562JTH	J24189034		1-	B	c2
R 1385	CHIPRES.	100k	1/16W	5%	RMC1/16S 104JTH	J24189049		1-	A	B3
R 1386	CHIPRES.	220k	1/16W	5%	RMC1/16S 224JTH	J24189053		1-	B	d2

# MAIN Unit

## Parts List

REF	DESCRIPTION	VALUE	V/W	TOL.	MFR'S DESIG	VXSTD P/N	VERS.	LOT	SIDE	LAYADR
R 1386	CHIPRES.	150k	1/16W	5%	RMC1/16S 154JTH	J24189051		25-	B	d2
R 1387	CHIPRES.	220k	1/16W	5%	RMC1/16S 224JTH	J24189053		1-	B	c1
R 1388	CHIPRES.	15k	1/16W	5%	RMC1/16S 153JTH	J24189039		1-	B	b1
R 1389	CHIPRES.	2.2k	1/16W	5%	RMC1/16S 222JTH	J24189029		1-	B	d1
R 1390	CHIPRES.	100	1/16W	5%	RMC1/16S 101JTH	J24189013		1-	B	e1
R 1391	CHIPRES.	150	1/16W	5%	RMC1/16S 151JTH	J24189015		1-	B	d3
R 1391	CHIPRES.	330	1/16W	5%	RMC1/16S 331JTH	J24189019		83-	B	d3
R 1392	CHIPRES.	68k	1/16W	5%	RMC1/16S 683JTH	J24189047		1-	A	B3
R 1393	CHIPRES.	68k	1/16W	5%	RMC1/16S 683JTH	J24189047		1-	B	d5
R 1394	CHIPRES.	2.2k	1/16W	5%	RMC1/16S 222JTH	J24189029		1	A	C3
R 1394	CHIPRES.	1k	1/16W	5%	RMC1/16S 102JTH	J24189025		2-	A	C3
R 1395	CHIPRES.	47k	1/16W	5%	RMC1/16S 473JTH	J24189045		1	A	D2
R 1395	CHIPRES.	47k	1/16W	5%	RMC1/16S 473JTH	J24189045		2-	A	D2
R 1396	CHIPRES.	100k	1/16W	5%	RMC1/16S 104JTH	J24189049		1-	B	c1
R 1396	CHIPRES.	10k	1/16W	5%	RMC1/16S 103JTH	J24189037		14-	B	c1
R 1397	CHIPRES.	22k	1/16W	5%	RMC1/16S 223JTH	J24189041		1-	B	b1
R 1397	CHIPRES.	100k	1/16W	5%	RMC1/16S 104JTH	J24189049		5-	B	b1
R 1398	CHIPRES.	68k	1/16W	5%	RMC1/16S 683JTH	J24189047		1-	B	d5
R 1399	CHIPRES.	100	1/10W	5%	RMC1/10T 101J	J24205101		1-	B	c5
R 1400	CHIPRES.	33k	1/16W	5%	RMC1/16S 333JTH	J24189043		1-	B	c2
R 1401	CHIPRES.	470k	1/16W	5%	RMC1/16S 474JTH	J24189057		1-	B	b1
R 1402	CHIPRES.	100	1/16W	5%	RMC1/16S 101JTH	J24189013		1-	A	B3
R 1403	CHIPRES.	2.2k	1/16W	5%	RMC1/16S 222JTH	J24189029		1-	A	B3
R 1404	CHIPRES.	2.2k	1/16W	5%	RMC1/16S 222JTH	J24189029		1	A	C2
R 1404	CHIPRES.	10k	1/16W	5%	RMC1/16S 103JTH	J24189037		2-	A	C2
R 1405	CHIPRES.	3.3k	1/16W	5%	RMC1/16S 332JTH	J24189031		1-	B	d5
R 1406	CHIPRES.	3.3k	1/16W	5%	RMC1/16S 332JTH	J24189031		1-	B	d5
R 1407	CHIPRES.	100	1/16W	5%	RMC1/16S 101JTH	J24189013		1-	B	d1
R 1407	CHIPRES.	150	1/16W	5%	RMC1/16S 151JTH	J24189015		25-	B	d1
R 1408	CHIPRES.	100	1/16W	5%	RMC1/16S 101JTH	J24189013		1-	A	C3
R 1409	CHIPRES.	10k	1/16W	5%	RMC1/16S 103JTH	J24189037		1-	B	d1
R 1410	CHIPRES.	10k	1/16W	5%	RMC1/16S 103JTH	J24189037		1-	B	d1
R 1411	CHIPRES.	330	1/16W	5%	RMC1/16S 331JTH	J24189019		1-	B	e5
R 1412	CHIPRES.	330	1/16W	5%	RMC1/16S 331JTH	J24189019		1-	B	d5
R 1413	CHIPRES.	330	1/16W	5%	RMC1/16S 331JTH	J24189019		1-	B	d5
R 1414	CHIPRES.	330	1/16W	5%	RMC1/16S 331JTH	J24189019		1-	B	d5
R 1415	CHIPRES.	4.7k	1/16W	5%	RMC1/16S 472JTH	J24189033		1-	B	c2
R 1416	CHIPRES.	10k	1/16W	5%	RMC1/16S 103JTH	J24189037		1-	B	c1
R 1417	CHIPRES.	6.8k	1/16W	5%	RMC1/16S 682JTH	J24189035		1-	B	c2
R 1418	CHIPRES.	10k	1/16W	5%	RMC1/16S 103JTH	J24189037		1-	B	d2
R 1419	CHIPRES.	33	1/16W	5%	RMC1/16S 330JTH	J24189007		1-	B	d3
R 1420	CHIPRES.	680k	1/16W	5%	RMC1/16S 684JTH	J24189059		1-	B	c2
R 1420	CHIPRES.	330k	1/16W	5%	RMC1/16S 334JTH	J24189055		81-	B	c2
R 1421	CHIPRES.	100k	1/16W	5%	RMC1/16S 104JTH	J24189049		1-	A	D2
R 1421	CHIPRES.	100k	1/16W	5%	RMC1/16S 104JTH	J24189049		25-	A	D2
R 1421	CHIPRES.	82k	1/16W	5%	RMC1/16S 823JTH	J24189048		37-	A	D2
R 1422	CHIPRES.	2.2M	1/16W	5%	RMC1/16S 225JTH	J24189065		1-	B	c2
R 1423	CHIPRES.	6.8k	1/16W	5%	RMC1/16S 682JTH	J24189035		1-	B	d4
R 1424	CHIPRES.	100	1/16W	5%	RMC1/16S 101JTH	J24189013		1-	B	c3
R 1425	CHIPRES.	10k	1/16W	5%	RMC1/16S 103JTH	J24189037		1-	B	d1
R 1426	CHIPRES.	10k	1/16W	5%	RMC1/16S 103JTH	J24189037		1-	B	d1
R 1427	CHIPRES.	100k	1/16W	5%	RMC1/16S 104JTH	J24189049		1-	B	d1
R 1428	CHIPRES.	10k	1/16W	5%	RMC1/16S 103JTH	J24189037		1-	A	D2
R 1429	CHIPRES.	100k	1/16W	5%	RMC1/16S 104JTH	J24189049		1-	B	c2
R 1430	CHIPRES.	100	1/16W	5%	RMC1/16S 101JTH	J24189013		1-	B	d2
R 1431	CHIPRES.	2.2k	1/16W	5%	RMC1/16S 222JTH	J24189029		1-	B	c2
R 1432	CHIPRES.	6.8k	1/16W	5%	RMC1/16S 682JTH	J24189035		1-	B	d4
R 1433	CHIPRES.	4.7k	1/16W	5%	RMC1/16S 472JTH	J24189033		1-	B	c2
R 1434	CHIPRES.	1k	1/16W	5%	RMC1/16S 102JTH	J24189025		1-	A	B3
R 1435	CHIPRES.	220k	1/16W	5%	RMC1/16S 224JTH	J24189053		1-	B	d2
R 1435	CHIPRES.	150k	1/16W	5%	RMC1/16S 154JTH	J24189051		25-	B	d2
R 1436	CHIPRES.	22k	1/16W	5%	RMC1/16S 223JTH	J24189041		1-	B	c2
R 1437	CHIPRES.	1.5k	1/16W	5%	RMC1/16S 152JTH	J24189027		1-	B	c2
R 1437	CHIPRES.	2.2k	1/16W	5%	RMC1/16S 222JTH	J24189029		86-	B	c2
R 1438	CHIPRES.	68	1/16W	5%	RMC1/16S 680JTH	J24189011		1-	B	d3
R 1438	CHIPRES.	22	1/16W	5%	RMC1/16S 220JTH	J24189005		83-	B	d3
R 1439	CHIPRES.	22k	1/16W	5%	RMC1/16S 223JTH	J24189041		1-	B	e3
R 1440	CHIPRES.	10k	1/16W	5%	RMC1/16S 103JTH	J24189037		1-	A	B3
R 1441	CHIPRES.	100k	1/16W	5%	RMC1/16S 104JTH	J24189049		1-	B	d2
R 1441	CHIPRES.	47k	1/16W	5%	RMC1/16S 473JTH	J24189045		25-	B	d2
R 1442	CHIPRES.	470	1/16W	5%	RMC1/16S 471JTH	J24189021		1-	B	d1
R 1443	CHIPRES.	1M	1/16W	5%	RMC1/16S 105JTH	J24189061		1-	B	c2
R 1444	CHIPRES.	270k	1/16W	5%	RMC1/16S 274JTH	J24189054		1-	A	D2

# MAIN Unit

## Parts List

REF	DESCRIPTION	VALUE	V/W	TOL.	MFR'S DESIG	VXSTD P/N	VERS.	LOT	SIDE	LAYADR
R 1444	CHIPRES.	150k	1/16W	5%	RMC1/16S 154JTH	J24189051		5-	A	D2
R 1444	CHIPRES.	150k	1/16W	5%	RMC1/16S 154JTH	J24189051		25-	A	D2
R 1446	CHIPRES.	100	1/16W	5%	RMC1/16S 101JTH	J24189013		1-	A	C1
R 1447	CHIPRES.	2.2k	1/16W	5%	RMC1/16S 222JTH	J24189029		1-	B	e1
R 1448	CHIPRES.	22k	1/16W	5%	RMC1/16S 223JTH	J24189041		1-	B	c1
R 1449	CHIPRES.	100k	1/16W	5%	RMC1/16S 104JTH	J24189049		1-	B	c2
R 1450	CHIPRES.	470k	1/16W	5%	RMC1/16S 474JTH	J24189057		1-	B	b2
R 1451	CHIPRES.	22k	1/16W	5%	RMC1/16S 223JTH	J24189041		1-	B	c1
R 1452	CHIPRES.	470	1/16W	5%	RMC1/16S 471JTH	J24189021		1-	A	B2
R 1453	CHIPRES.	1k	1/16W	5%	RMC1/16S 102JTH	J24189025		1-	B	c3
R 1454	CHIPRES.	220	1/16W	5%	RMC1/16S 221JTH	J24189017		1-	A	B3
R 1455	CHIPRES.	2.2M	1/16W	5%	RMC1/16S 225JTH	J24189065		1-	A	C1
R 1456	CHIPRES.	220k	1/16W	5%	RMC1/16S 224JTH	J24189053		1-	B	e2
R 1457	CHIPRES.	47k	1/16W	5%	RMC1/16S 473JTH	J24189045		1-	B	d3
R 1458	CHIPRES.	100k	1/16W	5%	RMC1/16S 104JTH	J24189049		1-	A	C1
R 1459	CHIPRES.	6.8k	1/16W	5%	RMC1/16S 682JTH	J24189035		1-	B	d4
R 1461	CHIPRES.	6.8k	1/16W	5%	RMC1/16S 682JTH	J24189035		1-	B	c2
R 1462	CHIPRES.	470	1/16W	5%	RMC1/16S 471JTH	J24189021		1-	B	d6
R 1463	CHIPRES.	68k	1/16W	5%	RMC1/16S 683JTH	J24189047		1-	A	D2
R 1463	CHIPRES.	47k	1/16W	5%	RMC1/16S 473JTH	J24189045		38-	A	D2
R 1464	CHIPRES.	22k	1/16W	5%	RMC1/16S 223JTH	J24189041		1-	B	e3
R 1466	CHIPRES.	1k	1/16W	5%	RMC1/16S 102JTH	J24189025		1-	B	d3
R 1467	CHIPRES.	6.8k	1/16W	5%	RMC1/16S 682JTH	J24189035		1-	B	d4
R 1468	CHIPRES.	330k	1/16W	5%	RMC1/16S 334JTH	J24189055		1-	B	d3
R 1469	CHIPRES.	4.7k	1/16W	5%	RMC1/16S 472JTH	J24189033		25-	A	C1
R 1470	CHIPRES.	4.7k	1/16W	5%	RMC1/16S 472JTH	J24189033		1-	B	d3
R 1471	CHIPRES.	33k	1/16W	5%	RMC1/16S 333JTH	J24189043		1-	B	c2
R 1472	CHIPRES.	100	1/16W	5%	RMC1/16S 101JTH	J24189013		1-	B	d3
R 1473	CHIPRES.	33k	1/16W	5%	RMC1/16S 333JTH	J24189043		1-	B	c1
R 1474	CHIPRES.	2.2M	1/16W	5%	RMC1/16S 225JTH	J24189065		1-	B	d4
R 1475	CHIPRES.	10k	1/16W	5%	RMC1/16S 103JTH	J24189037		1-	B	c2
R 1476	CHIPRES.	2.2k	1/16W	5%	RMC1/16S 222JTH	J24189029		1-	A	B2
R 1477	CHIPRES.	100k	1/16W	5%	RMC1/16S 104JTH	J24189049		1-	B	c2
R 1477	CHIPRES.	68k	1/16W	5%	RMC1/16S 683JTH	J24189047		86-	B	c2
R 1478	CHIPRES.	33k	1/16W	5%	RMC1/16S 333JTH	J24189043		1-	B	c2
R 1479	CHIPRES.	10k	1/16W	5%	RMC1/16S 103JTH	J24189037		1-	A	C1
R 1479	CHIPRES.	470	1/16W	5%	RMC1/16S 471JTH	J24189021		5-	A	C1
R 1479	CHIPRES.	100	1/16W	5%	RMC1/16S 101JTH	J24189013		25-	A	C1
R 1482	CHIPRES.	4.7k	1/16W	5%	RMC1/16S 472JTH	J24189033		1-	B	d3
R 1483	CHIPRES.	33k	1/16W	5%	RMC1/16S 333JTH	J24189043		1-	B	c1
R 1484	CHIPRES.	3.3k	1/16W	5%	RMC1/16S 332JTH	J24189031		1-	B	d3
R 1485	CHIPRES.	100k	1/16W	5%	RMC1/16S 104JTH	J24189049		67-	B	d3
R 1486	CHIPRES.	1k	1/16W	5%	RMC1/16S 102JTH	J24189025		1-	B	e3
R 1487	CHIPRES.	2.2M	1/16W	5%	RMC1/16S 225JTH	J24189065		1-	B	c1
R 1488	CHIPRES.	3.3k	1/16W	5%	RMC1/16S 332JTH	J24189031		1-	B	d3
R 1491	CHIPRES.	330k	1/16W	5%	RMC1/16S 334JTH	J24189055		1-	B	d3
R 1493	CHIPRES.	6.8k	1/16W	5%	RMC1/16S 682JTH	J24189035		1-	B	c2
R 1494	CHIPRES.	10k	1/16W	5%	RMC1/16S 103JTH	J24189037		1-	B	c1
R 1495	CHIPRES.	2.2k	1/16W	5%	RMC1/16S 222JTH	J24189029		1-	A	B3
R 1496	CHIPRES.	470	1/16W	5%	RMC1/16S 471JTH	J24189021		1-	B	e3
R 1497	CHIPRES.	100k	1/16W	5%	RMC1/16S 104JTH	J24189049		67-	B	d3
R 1498	CHIPRES.	47	1/16W	5%	RMC1/16S 470JTH	J24189009		1-	B	d4
R 1499	CHIPRES.	470	1/16W	5%	RMC1/16S 471JTH	J24189021		1-	B	e5
R 1500	CHIPRES.	470	1/16W	5%	RMC1/16S 471JTH	J24189021		1-	B	e5
R 1501	CHIPRES.	470	1/16W	5%	RMC1/16S 471JTH	J24189021		1-	B	e5
R 1502	CHIPRES.	470	1/16W	5%	RMC1/16S 471JTH	J24189021		1-	B	e5
R 1503	CHIPRES.	470	1/16W	5%	RMC1/16S 471JTH	J24189021		1-	B	e5
R 1504	CHIPRES.	470	1/16W	5%	RMC1/16S 471JTH	J24189021		1-	B	e6
R 1505	CHIPRES.	4.7k	1/16W	5%	RMC1/16S 472JTH	J24189033		1-	B	e3
R 1506	CHIPRES.	4.7k	1/16W	5%	RMC1/16S 472JTH	J24189033		1-	B	e3
R 1507	CHIPRES.	470	1/16W	5%	RMC1/16S 471JTH	J24189021		1-	B	e3
R 1508	CHIPRES.	470	1/16W	5%	RMC1/16S 471JTH	J24189021		1-	B	e3
R 1509	CHIPRES.	47k	1/16W	5%	RMC1/16S 473JTH	J24189045		1-	B	e4
R 1509	CHIPRES.	4.7k	1/16W	5%	RMC1/16S 472JTH	J24189033		14-	B	e4
R 1510	CHIPRES.	15k	1/16W	5%	RMC1/16S 153JTH	J24189039		1-	B	e4
R 1510	CHIPRES.	1.5k	1/16W	5%	RMC1/16S 152JTH	J24189027		14-	B	e4
R 1511	CHIPRES.	1	1W	5%	RMC1 1R0JTE	J24305010		1-	B	e4
R 1512	CHIPRES.	4.7k	1/16W	5%	RMC1/16S 472JTH	J24189033		1-	B	d2
R 1513	CHIPRES.	4.7k	1/16W	5%	RMC1/16S 472JTH	J24189033		1-	B	e2
R 1514	CHIPRES.	470	1/16W	5%	RMC1/16S 471JTH	J24189021		1-	B	d2
R 1515	CHIPRES.	470	1/16W	5%	RMC1/16S 471JTH	J24189021		1-	B	d2
R 1516	CHIPRES.	4.7k	1/16W	5%	RMC1/16S 472JTH	J24189033		1-	B	e1
R 1517	CHIPRES.	4.7k	1/16W	5%	RMC1/16S 472JTH	J24189033		1-	B	e1

# MAIN Unit

## Parts List

REF	DESCRIPTION	VALUE	V/W	TOL.	MFR'S DESIG	VXSTD P/N	VERS.	LOT	SIDE	LAYADR
R 1518	CHIPRES.	1k	1/16W	5%	RMC1/16S 102JTH	J24189025		1-	B	d2
R 1519	CHIPRES.	220	1/4W	5%	RMC1/4 221JATP	J24245221		1-	B	e4
R 1520	CHIPRES.	4.7	1/10W	5%	RMC1/10T 4R7J	J24205479		1-	B	e4
R 1521	CHIPRES.	47	1/16W	5%	RMC1/16S 470JTH	J24189009		1-	B	e1
R 1522	CHIPRES.	47	1/16W	5%	RMC1/16S 470JTH	J24189009		1-	B	e1
R 1523	CHIPRES.	4.7k	1/16W	5%	RMC1/16S 472JTH	J24189033		1-	B	d2
R 1524	CHIPRES.	47	1/16W	5%	RMC1/16S 470JTH	J24189009		1-	B	d2
R 1525	CHIPRES.	4.7	1/10W	5%	RMC1/10T 4R7J	J24205479		1-	B	e4
R 1526	CHIPRES.	1.5k	1/16W	5%	RMC1/16S 152JTH	J24189027		1-	B	d2
R 1527	CHIPRES.	47	1/16W	5%	RMC1/16S 470JTH	J24189009		1-	B	d2
R 1528	CHIPRES.	220	1/16W	5%	RMC1/16S 221JTH	J24189017		1-	B	e4
R 1530	CHIPRES.	0	1/10W	5%	RMC1/10T 000J	J24205000		1-24		
R 1531	CHIPRES.	0	1/10W	5%	RMC1/10T 000J	J24205000		1-24		
R 1533	CHIPRES.	2.2k	1/16W	5%	RMC1/16S 222JTH	J24189029		1-	B	e2
R 1533	CHIPRES.	4.7k	1/16W	5%	RMC1/16S 472JTH	J24189033		83-	B	e2
R 1534	CHIPRES.	47	1/16W	5%	RMC1/16S 470JTH	J24189009		1-	B	e2
R 1535	CHIPRES.	470	1/16W	5%	RMC1/16S 471JTH	J24189021		1-	B	e6
R 1536	CHIPRES.	1k	1/16W	5%	RMC1/16S 102JTH	J24189025		1-		
R 1536	CHIPRES.	0	1/16W	5%	RMC1/16S JPTH	J24189070		4-24		
R 1537	CHIPRES.	10k	1/16W	5%	RMC1/16S 103JTH	J24189037		1-	B	e2
R 1538	CHIPRES.	470	1/4W	5%	RMC1/4 471JATP	J24245471		1-	B	b1
R 1539	CHIPRES.	1k	1/16W	5%	RMC1/16S 102JTH	J24189025		1-	B	f6
R 1539	CHIPRES.	470	1/16W	5%	RMC1/16S 471JTH	J24189021		4-	B	f6
R 1541	CHIPRES.	15k	1/16W	5%	RMC1/16S 153JTH	J24189039		1-	B	e6
R 1542	CHIPRES.	220	1/16W	5%	RMC1/16S 221JTH	J24189017		1-	A	A3
R 1543	CHIPRES.	470	1/16W	5%	RMC1/16S 471JTH	J24189021		1-	B	e6
R 1544	CHIPRES.	1k	1/16W	5%	RMC1/16S 102JTH	J24189025		1-	A	B6
R 1544	CHIPRES.	470	1/16W	5%	RMC1/16S 471JTH	J24189021		4-	A	B6
R 1545	CHIPRES.	1k	1/16W	5%	RMC1/16S 102JTH	J24189025		1-	A	B6
R 1545	CHIPRES.	470	1/16W	5%	RMC1/16S 471JTH	J24189021		4-	A	B6
R 1546	CHIPRES.	150k	1/16W	5%	RMC1/16S 154JTH	J24189051		1-	B	e6
R 1547	CHIPRES.	68k	1/16W	5%	RMC1/16S 683JTH	J24189047		1-	B	e6
R 1548	CHIPRES.	1k	1/16W	5%	RMC1/16S 102JTH	J24189025		1-	A	B6
R 1548	CHIPRES.	470	1/16W	5%	RMC1/16S 471JTH	J24189021		4-	A	B6
R 1549	CHIPRES.	1k	1/16W	5%	RMC1/16S 102JTH	J24189025		1-	A	B6
R 1549	CHIPRES.	470	1/16W	5%	RMC1/16S 471JTH	J24189021		4-	A	B6
R 1550	CHIPRES.	0	1/16W	5%	RMC1/16 000JATP	J24185000		1-	A	B6
R 1551	CHIPRES.	10k	1/16W	5%	RMC1/16S 103JTH	J24189037		1-	B	d1
R 1552	CHIPRES.	10k	1/16W	5%	RMC1/16S 103JTH	J24189037		1-	B	e6
R 1553	CHIPRES.	220	1/16W	5%	RMC1/16S 221JTH	J24189017		1-	B	c1
R 1554	CHIPRES.	220	1/16W	5%	RMC1/16S 221JTH	J24189017		1-	B	c1
R 1555	CHIPRES.	1k	1/16W	5%	RMC1/16S 102JTH	J24189025		1-	B	c1
R 1556	CHIPRES.	0	1/16W	5%	RMC1/16 000JATP	J24185000		1-	A	B4
R 1557	CHIPRES.	1k	1/16W	5%	RMC1/16S 102JTH	J24189025		1-	B	d1
R 1558	CHIPRES.	1k	1/16W	5%	RMC1/16S 102JTH	J24189025		1-	B	d1
R 1559	CHIPRES.	1k	1/16W	5%	RMC1/16S 102JTH	J24189025		1-	B	c1
R 1560	CHIPRES.	1k	1/16W	5%	RMC1/16S 102JTH	J24189025		1-	B	c1
R 1561	CHIPRES.	1k	1/16W	5%	RMC1/16S 102JTH	J24189025		1-	B	c1
R 1562	CHIPRES.	1k	1/16W	5%	RMC1/16S 102JTH	J24189025		1-	B	c1
R 1563	CHIPRES.	1k	1/16W	5%	RMC1/16S 102JTH	J24189025		1-	B	d1
R 1565	CHIPRES.	1k	1/16W	5%	RMC1/16S 102JTH	J24189025		1-	B	e1
R 1566	CHIPRES.	1k	1/16W	5%	RMC1/16S 102JTH	J24189025		1-	B	e1
R 1567	CHIPRES.	1k	1/16W	5%	RMC1/16S 102JTH	J24189025		25-	A	D1
R 1568	CHIPRES.	1k	1/16W	5%	RMC1/16S 102JTH	J24189025		25-	B	d1
R 1569	CHIPRES.	1k	1/16W	5%	RMC1/16S 102JTH	J24189025		1-	B	f6
R 1569	CHIPRES.	470	1/16W	5%	RMC1/16S 471JTH	J24189021		4-	B	f6
R 1570	CHIPRES.	1k	1/16W	5%	RMC1/16S 102JTH	J24189025		1-	B	f6
R 1570	CHIPRES.	470	1/16W	5%	RMC1/16S 471JTH	J24189021		4-	B	f6
R 1571	CHIPRES.	1k	1/16W	5%	RMC1/16S 102JTH	J24189025		1-	A	A6
R 1572	CHIPRES.	1k	1/16W	5%	RMC1/16S 102JTH	J24189025		1-	B	e6
R 1572	CHIPRES.	0	1/16W	5%	RMC1/16S JPTH	J24189070		4-	B	e6
R 1573	CHIPRES.	1k	1/16W	5%	RMC1/16S 102JTH	J24189025		1-	B	e6
R 1576	CHIPRES.	0	1/10W	5%	RMC1/10T 000J	J24205000		1-24		
R 1577	CHIPRES.	3.9	1/2W	5%	RMC1/2 3R9JATP	J24275399		1-	B	f1
R 1578	CHIPRES.	1.5k	1/16W	5%	RMC1/16S 152JTH	J24189027		1-	B	d3
R 1579	CHIPRES.	47k	1/16W	5%	RMC1/16S 473JTH	J24189045		1-	A	B3
R 1580	CHIPRES.	1.5k	1/16W	5%	RMC1/16S 152JTH	J24189027		1-	B	d2
R 1581	CHIPRES.	10k	1/16W	5%	RMC1/16S 103JTH	J24189037		1-	A	B1
R 1582	CHIPRES.	4.7k	1/16W	5%	RMC1/16S 472JTH	J24189033		1-	A	C1
R 1583	CHIPRES.	4.7k	1/16W	5%	RMC1/16S 472JTH	J24189033		1-	B	c1
R 1584	CHIPRES.	10k	1/16W	5%	RMC1/16S 103JTH	J24189037		1-	B	c1
R 1585	CHIPRES.	10k	1/16W	5%	RMC1/16S 103JTH	J24189037		1-	A	D2
R 1586	CHIPRES.	4.7k	1/16W	5%	RMC1/16S 472JTH	J24189033		1-	A	D1



# MAIN Unit

## Parts List

REF	DESCRIPTION	VALUE	V/W	TOL.	MFR'S DESIG	VXSTD P/N	VERS.	LOT	SDE	LAYADR
R 1587	CHIPRES.	2.2M	1/16W	5%	RMC1/16S 225JTH	J24189065		1-	B	b1
R 1588	CHIPRES.	10k	1/16W	5%	RMC1/16S 103JTH	J24189037		1-	B	c1
R 1589	CHIPRES.	470	1/16W	5%	RMC1/16 471JATP	J24185471		1-	A	E3
R 1590	CHIPRES.	15k	1/16W	5%	RMC1/16S 153JTH	J24189039		1-	A	C1
R 1591	CHIPRES.	330	1/16W	5%	RMC1/16S 331JTH	J24189019		1-75	B	d3
R 1592	CHIPRES.	0	1/16W	5%	RMC1/16S JPTH	J24189070		1-	B	f6
R 1593	CHIPRES.	0	1/16W	5%	RMC1/16S JPTH	J24189070		1-	B	e6
R 1594	CHIPRES.	4.7k	1/16W	5%	RMC1/16S 472JTH	J24189033		1-	B	e5
R 1595	CHIPRES.	6.8	1/10W	5%	RMC1/10T 6R8J	J24205689		1-	B	e5
R 1595	CHIPRES.	15	1/4W	5%	RMC1/4 150JATP	J24245150		25-	B	e5
R 1596	CHIPRES.	10k	1/16W	5%	RMC1/16S 103JTH	J24189037		1-	B	c2
R 1597	CHIPRES.	4.7	1/16W	5%	RMC1/16 4R7JATP	J24185479		1-	B	a5
R 1597	CHIPRES.	10	1/16W	5%	RMC1/16 100JATP	J24185100		14	B	a5
R 1597	CHIPRES.	12	1/16W	5%	RMC1/16 120JATP	J24185120		15-	B	a5
R 1597	CHIPRES.	27	1/16W	5%	RMC1/16 270JATP	J24185270		21-24	B	a5
R 1599	CHIPRES.	220	1/16W	5%	RMC1/16S 221JTH	J24189017		1-	B	c4
R 1599	CHIPRES.	120	1/16W	5%	RMC1/16S 121JTH	J24189014		25-	B	c4
R 1600	CHIPRES.	220k	1/16W	5%	RMC1/16S 224JTH	J24189053		1-	B	c2
R 1601	CARBON FILM RES.	10k	1/6W	5%	RD16PJ103 10K	J01225103		1-	B	b4
R 1601	CHIPRES.	10k	1/16W	5%	RMC1/16S 103JTH	J24189037		4-	B	b4
R 1602	CHIPRES.	0	1/16W	5%	RMC1/16S JPTH	J24189070		4-	A	C5
R 1603	CHIPRES.	68k	1/16W	5%	RMC1/16S 683JTH	J24189047		1-	B	b3
R 1603	CHIPRES.	33k	1/16W	5%	RMC1/16S 333JTH	J24189043		14-	B	b3
R 1603	CHIPRES.	68k	1/16W	5%	RMC1/16S 683JTH	J24189047		38-	B	b3
R 1603	CHIPRES.	47k	1/16W	5%	RMC1/16S 473JTH	J24189045		43-	B	b3
R 1604	CARBON FILM RES.	1M	1/6W	5%	RD16PJ105 1M	J01225105		1-	B	b3
R 1604	CHIPRES.	1M	1/16W	5%	RMC1/16S 105JTH	J24189061		4-	B	b3
R 1604	CHIPRES.	100k	1/16W	5%	RMC1/16S 104JTH	J24189049		25-	B	b3
R 1605	CARBON FILM RES.	10k	1/6W	5%	RD16PJ103 10K	J01225103		1-	B	d4
R 1605	CHIPRES.	10k	1/16W	5%	RMC1/16S 103JTH	J24189037		4-	B	d4
R 1606	CHIPRES.	10k	1/16W	5%	RMC1/16S 103JTH	J24189037		4-	A	B5
R 1609	CHIPRES.	2.2k	1/16W	5%	RMC1/16 222JATP	J24185222		1-	A	D4
R 1609	CHIPRES.	2.2k	1/16W	5%	RMC1/16S 222JTH	J24189029		4-	A	D4
R 1610	CARBON FILM RES.	68k	1/6W	5%	RD16PJ683 68K	J01225683		1-	B	c2
R 1610	CHIPRES.	68k	1/16W	5%	RMC1/16S 683JTH	J24189047		25-	B	c2
R 1611	CHIPRES.	220	1/16W	5%	RMC1/16 221JATP	J24185221		1-	A	D4
R 1611	CHIPRES.	220	1/16W	5%	RMC1/16S 221JTH	J24189017		25-	A	D4
R 1612	CHIPRES.	100k	1/16W	5%	RMC1/16S 104JTH	J24189049		25-	A	A6
R 1613	CHIPRES.	470	1/16W	5%	RMC1/16S 471JTH	J24189021		25-	B	f6
R 1614	CHIPRES.	100k	1/16W	5%	RMC1/16S 104JTH	J24189049		25-	A	B6
R 1617	CHIPRES.	10k	1/16W	5%	RMC1/16S 103JTH	J24189037		25-	A	B6
R 1618	CHIPRES.	10k	1/16W	5%	RMC1/16S 103JTH	J24189037		25-	A	A6
R 1619	CHIPRES.	0	1/16W	5%	RMC1/16S JPTH	J24189070		25-	B	d4
R 1620	CHIPRES.	0	1/16W	5%	RMC1/16S JPTH	J24189070		25-	B	d4
R 1621	CHIPRES.	0	1/16W	5%	RMC1/16S JPTH	J24189070		25-	B	d5
R 1622	CHIPRES.	10k	1/16W	5%	RMC1/16S 103JTH	J24189037		25-	A	B5
R 1623	CHIPRES.	10k	1/16W	5%	RMC1/16S 103JTH	J24189037		25-	A	B5
R 1624	CHIPRES.	10k	1/16W	5%	RMC1/16S 103JTH	J24189037		25-	A	B5
R 1625	CHIPRES.	100k	1/16W	5%	RMC1/16S 104JTH	J24189049		25-	B	d5
R 1630	CHIPRES.	4.7k	1/16W	5%	RMC1/16S 472JTH	J24189033		25-	A	B6
R 1631	CHIPRES.	100k	1/16W	5%	RMC1/16S 104JTH	J24189049		25-	A	B6
R 1632	CHIPRES.	100	1/16W	5%	RMC1/16S 101JTH	J24189013		25-	B	d6
R 1635	CHIPRES.	1k	1/16W	5%	RMC1/16S 102JTH	J24189025		25-	B	e5
R 1638	CHIPRES.	220k	1/16W	5%	RMC1/16S 224JTH	J24189053		25-	B	c3
R 1639	CHIPRES.	220k	1/16W	5%	RMC1/16S 224JTH	J24189053		25-	B	d2
R 1640	CHIPRES.	220k	1/16W	5%	RMC1/16S 224JTH	J24189053		25-	B	d2
R 1641	CHIPRES.	3.9k	1/16W	5%	RMC1/16 392JATP	J24185392		25-	B	a5
R 1641	CHIPRES.	2.2k	1/16W	5%	RMC1/16 222JATP	J24185222		38-	B	a5
R 1642	CHIPRES.	100	1/16W	5%	RMC1/16S 101JTH	J24189013		50-	B	b3
R 1643	CHIPRES.	0	1/16W	5%	RMC1/16S JPTH	J24189070		50-	B	a4
R 1643	CHIPRES.	15	1/16W	5%	RMC1/16S 150JTH	J24189003		76-	B	a4
R 1644	CHIPRES.	0	1/16W	5%	RMC1/16S JPTH	J24189070		50-	B	a4
R 1644	CHIPRES.	15	1/16W	5%	RMC1/16S 150JTH	J24189003		76-	B	a4
R 1645	CHIPRES.	82	1/16W	5%	RMC1/16S 820JTH	J24189012		76-	B	a4
R 1646	CHIPRES.	100k	1/16W	5%	RMC1/16S 104JTH	J24189049		67-		
R 1647	CHIPRES.	470k	1/16W	5%	RMC1/16 474JATP	J24185474		67-		
R 1648	CHIPRES.	33k	1/16W	5%	RMC1/16S 333JTH	J24189043		81-		
R 1649	CHIPRES.	0	1/8W	5%	RMC1/8T 000J	J24215000		81-81		
R 1649	CHIPRES.	3.9k	1/16W	5%	RMC1/16S 392JTH	J24189032		86-		
R 1649	CHIPRES.	3.3k	1/16W	5%	RMC1/16S 332JTH	J24189031		88-		
R 1650	CHIPRES.	47k	1/16W	5%	RMC1/16S 473JTH	J24189045		86-		
RB1001	BLOCK RES.				SR4E103JT	J42900027		1-24		
RB1002	BLOCK RES.				SR4E103JT	J42900027		1-	A	B5

# MAIN Unit

## Parts List

REF	DESCRIPTION	VALUE	V/W	TOL.	MFR'S DESIG	VXSTD P/N	VERS.	LOT	SIDE	LAYADR
RB1003	BLOCK RES.				SR4E103JT	J42900027		1-	B	e2
RB1004	BLOCK RES.				SR4E103JT	J42900027		1-24		
RL1001	RELAY		DC12V		AHY123 L01 DC12V	M1190149		1-	A	A3
RL1001	RELAY		DC12V		G5V-1 DC12V	M1190120		9-	A	A3
S 1001	SLIDE SWITCH				SSSS222700	N6090057		1-	A	D5
T 1001	COIL PWR-WIDE				A0898	L0022552		1-	A	C6
T 1002	COIL PWR-WIDE				3A TR9.3X4.8X5.0	L0022642A		1-	A	C6
T 1002	COIL PWR-WIDE				ESD-R-10D	L0022847		21-	A	C6
T 1003	COIL PWR-WIDE				3A6 RIB8X14X6.5	L0022641A		1-	A	E6
T 1004	COIL 05RF				100M 010812300A	L0022779		1-	A	C4
T 1005	COIL 05RF				100M 010812300A	L0022779		1-	A	D4
T 1006	COIL 05RF				100M 010812300A	L0022779		1-	A	D5
T 1007	COIL WIDE-TRANS.				3-318707	L0022619		1-	A	D4
T 1008	COIL 05RF				100M 010812300A	L0022779		1-	A	D4
T 1009	COIL 05RF				100M 010812300A	L0022779		1-	A	D5
T 1010	COIL 05RF				100M 010812300A	L0022779		1-	A	D5
T 1011	COIL 05RF				100M 010812300A	L0022779		1-	A	F4
T 1012	COIL 05RF				100M 010812300A	L0022779		1-	A	F4
T 1013	COIL 05RF				100M 010812300A	L0022779		1-	A	F3
T 1014	COIL 05RF				74.62M 010812302	L0022781		1-	A	D3
T 1015	BALUN TRANSFORMERS				#458DB-1616=P3	L0190246		1-	A	E3
T 1016	BALUN TRANSFORMERS				#458DB-1616=P3	L0190246		1-	A	E3
T 1017	COIL WIDE-TRANS.				3-317611	L0022478		1-	A	E4
T 1018	COIL 05RF				74.62M 010812302	L0022781		1-	A	D1
T 1018	COIL 05RF				74.62M 010812303	L0022782		25-	A	D1
T 1019	COIL 05RF				74.62M 010812302	L0022781		1-	A	D2
T 1020	COIL WIDE-TRANS.				3-317610	L0022479		1-	A	E3
T 1021	COIL 05RF				74.62M 010812302	L0022781		1-	A	D3
T 1022	COIL WIDE-TRANS.				3-317611	L0022478		1-	A	D3
T 1023	COIL 05RF				74.62M 010812303	L0022782		1-	A	D3
T 1023	COIL 05RF	74.62MHz			74.62M 030812396C	L0022854		25-	A	D3
T 1024	COIL 05RF				74.62M 010812303	L0022782		1-	A	D3
T 1024	COIL 05RF	74.62MHz			74.62M 030812396C	L0022854		25-	A	D3
T 1025	COIL 05RF	455kHz			455K 030812470	L0022778		1-	A	D1
T 1026	COIL 05RF				74.62M 010812303	L0022782		1-	A	C3
T 1026	COIL 05RF	74.62MHz			74.62M 030812396C	L0022854		25-	A	C3
T 1027	COIL 05RF	455kHz			455K 030812471	L0022780		1-	A	B3
T 1028	COIL 05RF				50M 010812304	L0022783		1-	A	C3
T 1029	COIL 05RF	455kHz			455K 030812470	L0022778		1-	A	C2
T 1030	COIL 05RF				74.62M 010812302	L0022781		1-	A	C3
T 1031	COIL 05RF	455kHz			455K 030812471	L0022780		1-	A	B3
T 1032	COIL WIDE-TRANS.				3-317611	L0022478		1-	A	C3
T 1033	COIL 05RF	455kHz			455K 030812470	L0022778		1-	A	C3
T 1034	COIL 05RF	455kHz			455K 030812471	L0022780		1-	A	B2
T 1035	COIL 05RF	455kHz			455K 030812470	L0022778		1-	A	B3
T 1036	COIL 05RF	455kHz			455K 030812471	L0022780		1-	A	B3
T 1037	COIL 05RF	455kHz			455K 030812471	L0022780		1-	A	B3
TC1001	TRIMMERCAP.	3pF			ECR-KN003A61X 3P	K91000264		1-	A	C4
TC1001	TRIMMERCAP.	3pF			TZC3Z030A110R00	K91000280		130-	A	C4
TC1002	TRIMMERCAP.	6pF			ECR-KN006A61X 6P	K91000225		1-	A	E4
TC1002	TRIMMERCAP.	6pF			TZC3Z060A110R00	K91000281		130-	A	E4
TC1003	TRIMMERCAP.	6pF			ECR-KN006A61X 6P	K91000225		1-	A	E4
TC1003	TRIMMERCAP.	6pF			TZC3Z060A110R00	K91000281		130-	A	E4
TC1004	TRIMMERCAP.	6pF			ECR-KN006A61X 6P	K91000225		1-	A	E3
TC1004	TRIMMERCAP.	6pF			TZC3Z060A110R00	K91000281		130-	A	E3
TC1005	TRIMMERCAP.	10pF			ECR-KN010C61X	K91000226		1-	A	E4
TC1005	TRIMMERCAP.	10pF			TZC3R100A110R00	K91000282		121-	A	E4
TH1001	THERMISTOR				TBPS1R223K460H5Q	G9090085		1-	B	a6
VR1001	POT.	1k			EVN-5ESX50B13	J51811102		1-	A	D5
VR1002	POT.	1k			EVN-5ESX50B13	J51811102		1-	A	D6
VR1003	POT.	2.2k			EVN-5ESX50BE3	J51811222		1-	A	E5
VR1004	POT.	2.2k			EVN-5ESX50BE3	J51811222		1-	A	E5
VR1005	POT.	10k			EVN-5ESX50B14	J51811103		1-	A	C2
X 1001	XTAL TSS-6035B	19.82MHz			19.820MHZ	H0103262		1-	A	C5
X 1001	XTAL TSS-6035B	19.82MHz			19.820MHZ	H0103262A		68-	A	C5
X 1002	XTAL TSS-7050A	22.7785MHz			22.7785MHZ	H0103277		1-	B	b2
X 1002	XTAL TSS-7050A-2	22778.5kHz			22778.5KHz	H0103277A		48-	B	b2
X 1003	XTAL TSS-7050A	8.23MHz			8.230MHZ	H0103261		1-	B	e6
XF1001	XTAL FILTER				MF68Q TR-6(3)	H1102349		1-	A	D3
XF1001	XTAL FILTER				MFT68Q 68.33MHZ	H1102372		25-	A	D3
	HEATSINK PLATE				(MIXER)	RA0416500		1-	B	c6
	SHIELD CASE				(MIXER)	RA0439400	AUSTRALIA	1-		
	SHIELD CASE				(MIXER)	RA0439400	EXPORT	1-		

# MAIN Unit

## Parts List

REF	DESCRIPTION	VALUE	V/W	TOL.	MFR'S DESIG	VXSTD P/N	VERS.	LOT	SDE	LAYADR
	SHIELD CASE				(MIXER)	RA0439400	FRANCE	1-		
	SHIELD CASE				(MIXER)	RA0439400	USA	1-		
	SHIELDSHEET					RA0459300		1-		
	SHEET					RA0638900		41-49		
	SHEET					RA0638900		41-49		

*MAIN Unit*

*Note:*

Circuit Diagram

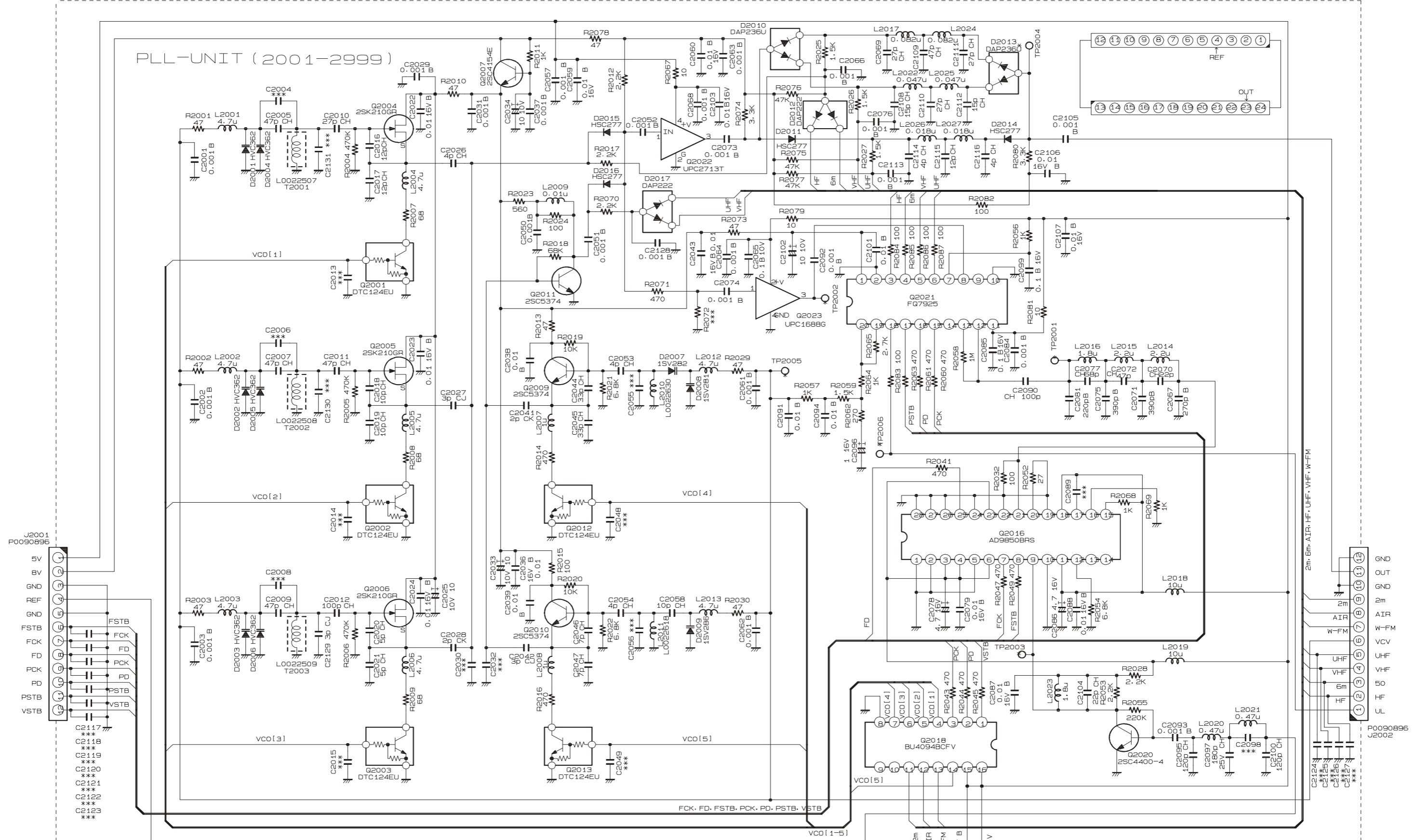

NOTE:  
 RESISTOR VALUES ARE IN Ω. 1/16W;  
 CAPACITOR VALUES ARE IN μF. 50V;  
 ELECTROLYTIC CAPACITOR ARE IN μF. 16V;  
 INDUCTOR VALUES ARE IN H;  
 COILS VALUES ARE IN H;  
 UNLESS OTHERWISE NOTED.

*PLL Unit (Lot. 1 ~ 18)*

*Note:*

## Parts Layout

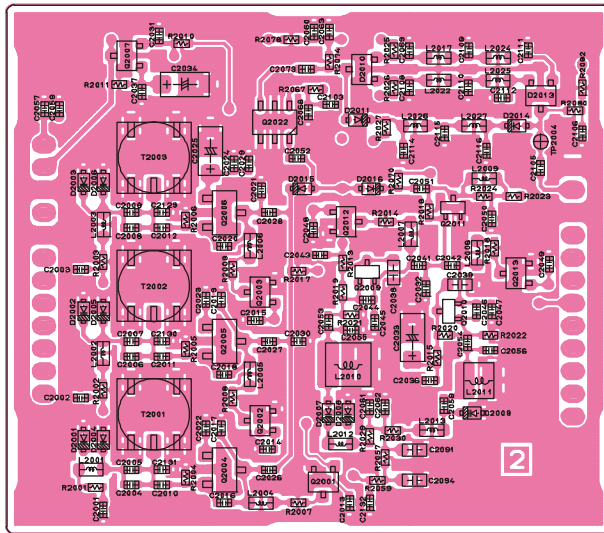

Side A

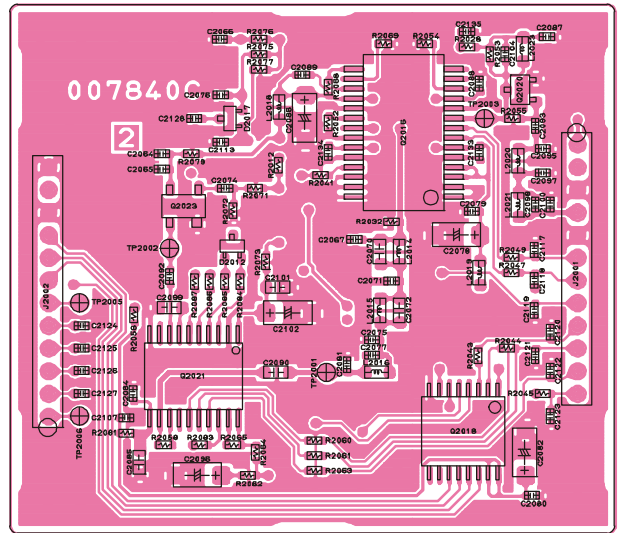

Side B

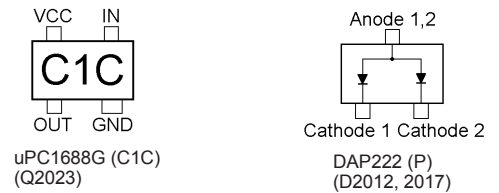
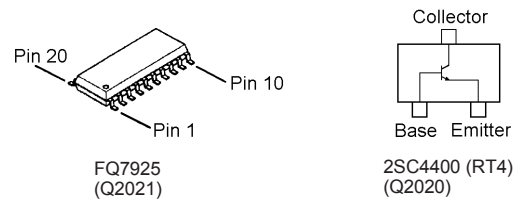
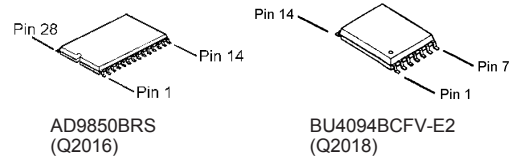
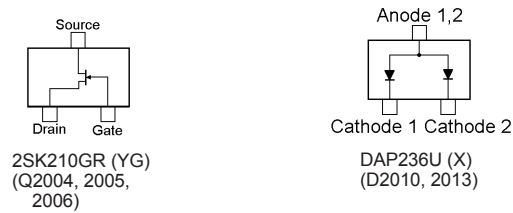
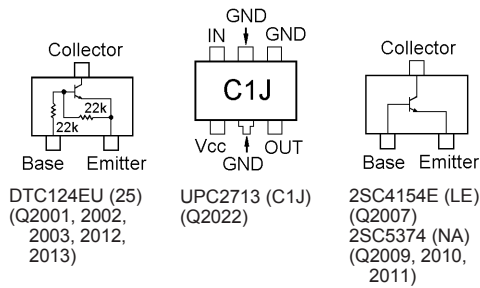

## *PLL Unit (Lot. 1 ~ 18)*

*Note:*



Circuit Diagram

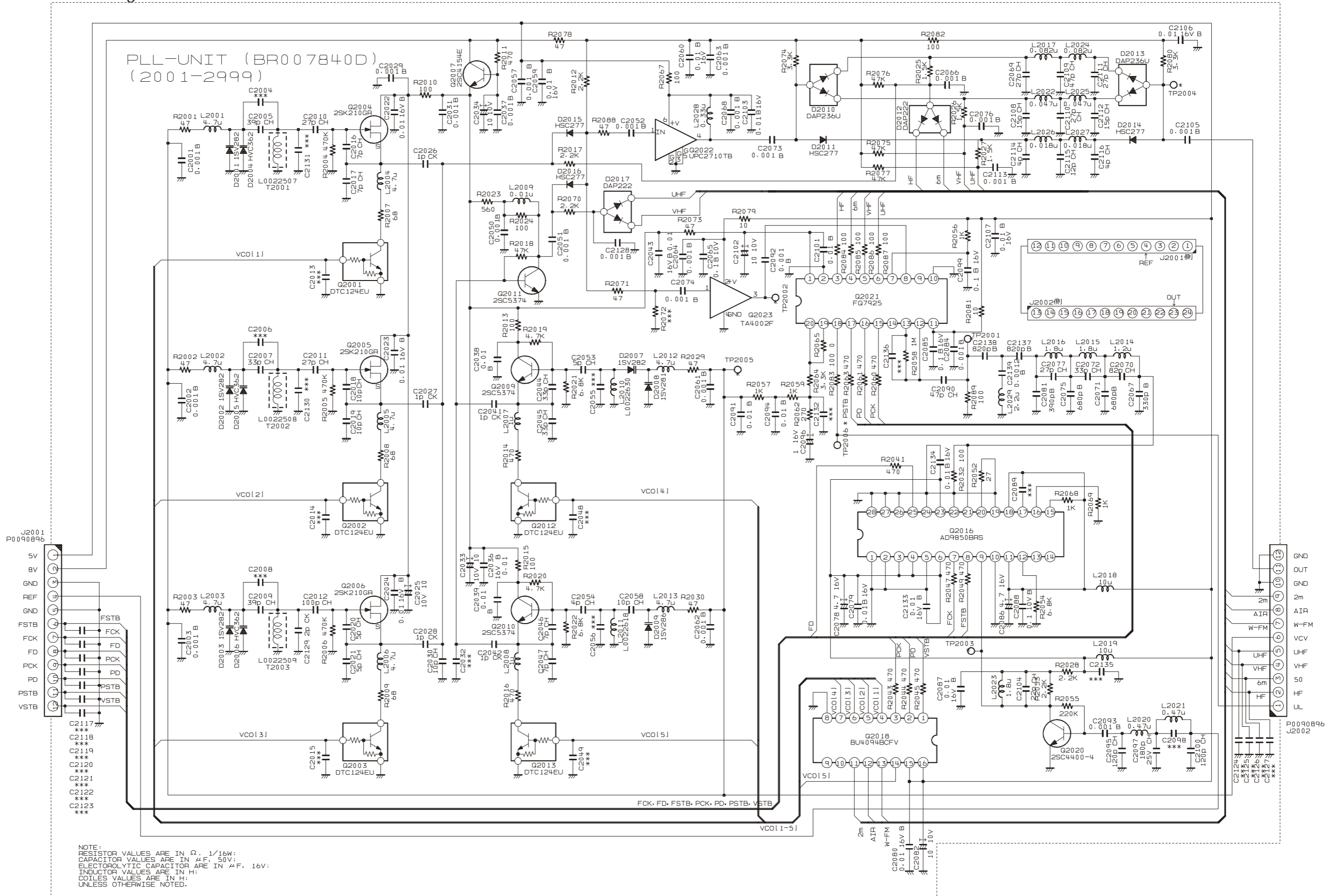

*PLL Unit (Lot. 19 ~ 74)*

*Note:*

Parts Layout

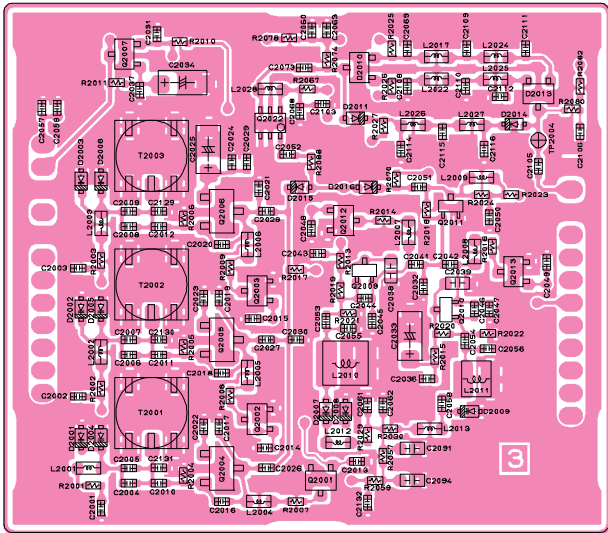

Side A

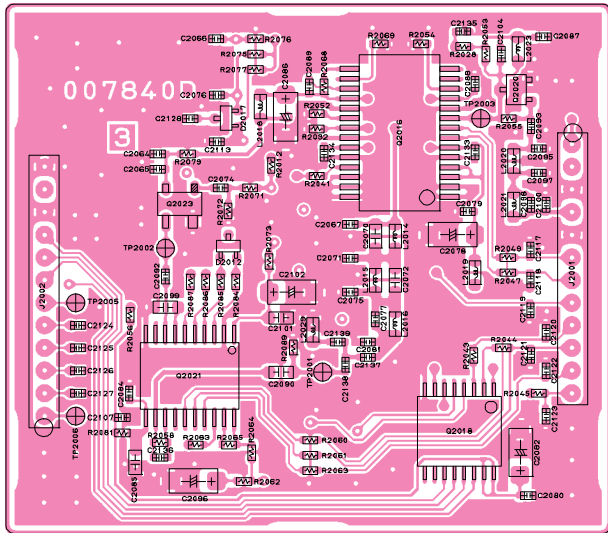

Side B

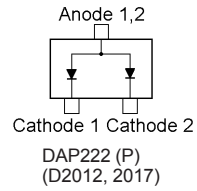
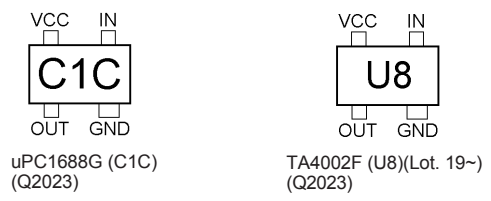
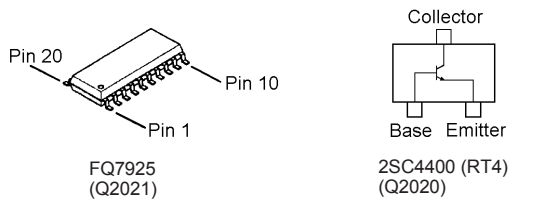
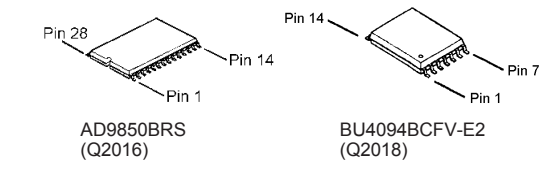
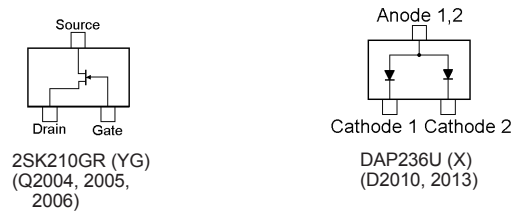
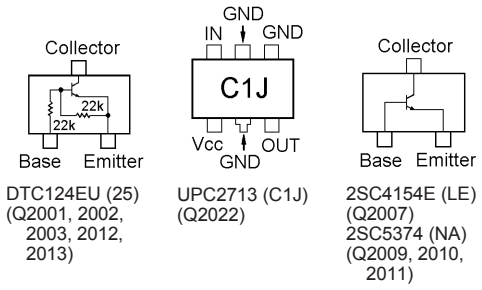

## *PLL Unit (Lot. 1 ~ 18)*

*Note:*

Circuit Diagram

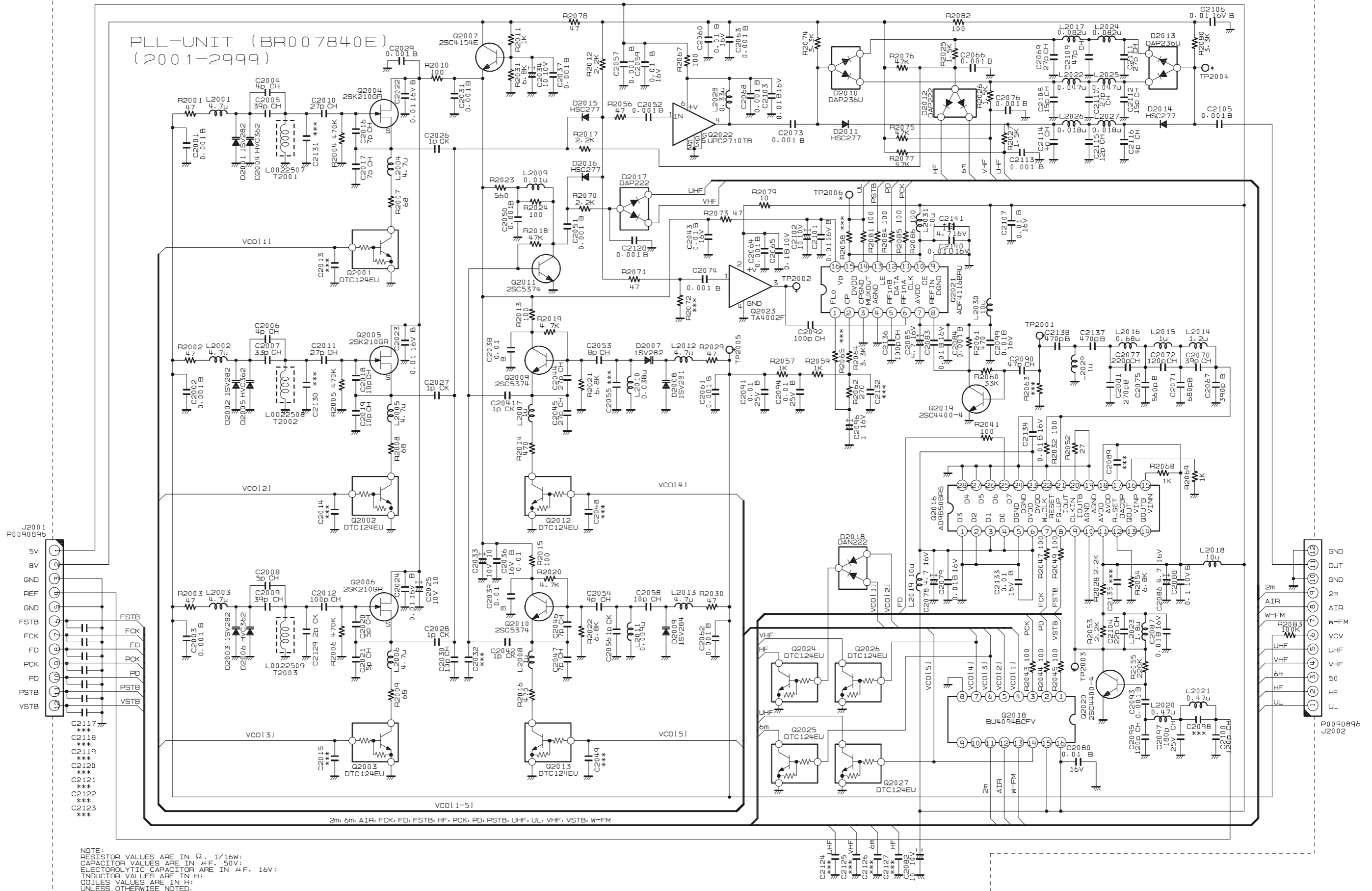

*PLL Unit (Lot. 75 ~)*

*Note:*

## Parts Layout

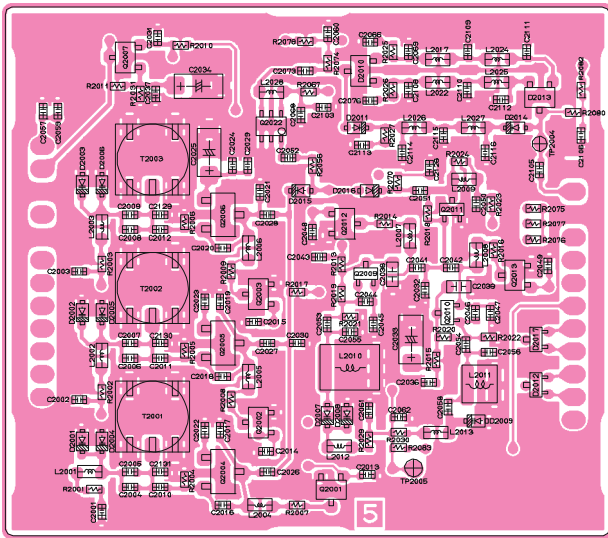

Side A

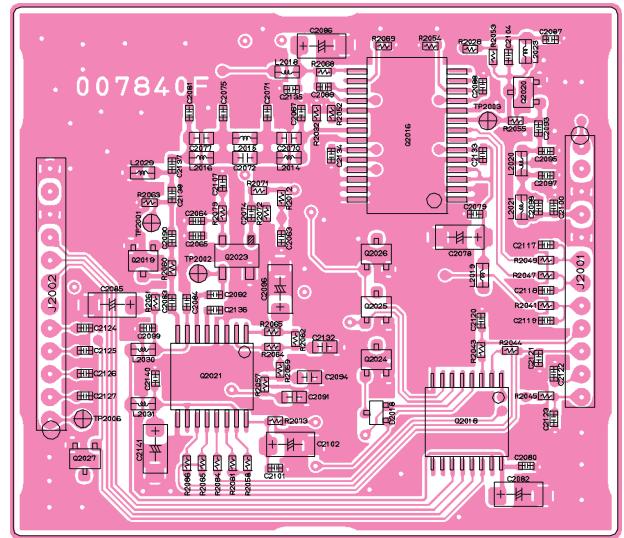

Side B

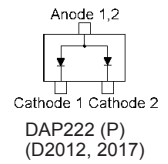
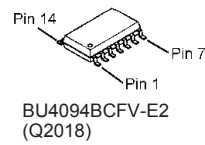
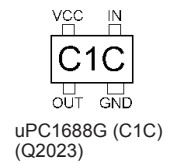
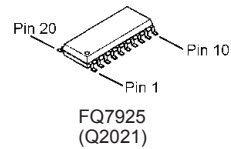
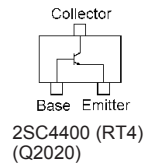
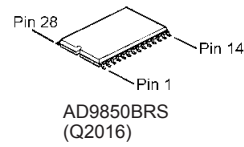
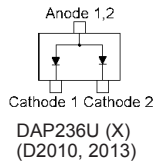
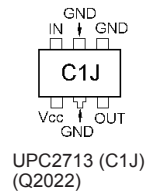
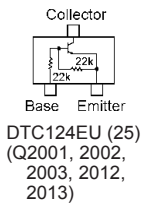
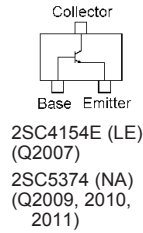
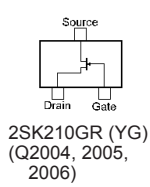

*PLL Unit (Lot 75 ~)*



# PLL Unit

## Parts List

REF	DESCRIPTION	VALUE	V/W	TOL.	MFR'S DESIG	VXSTD P/N	VERS.	LOT	SIDE	LAYADR
PCB with Components						CB1995001				
Printed Circuit Board						FR007840C		1-18		
						FR007840D		19-74		
						FR007840F		75-		
C 2001	CHIP CAP.	0.001uF	50V	B	UMK105B102KW-F	K22178829		1-	A	A2
C 2001	CHIP CAP.	0.001uF	50V	B	GRM155B11H102KA01D	K22178809		75-	A	A2
C 2002	CHIP CAP.	0.001uF	50V	B	UMK105B102KW-F	K22178829		1-	A	A2
C 2002	CHIP CAP.	0.001uF	50V	B	GRM155B11H102KA01D	K22178809		75-	A	A2
C 2003	CHIP CAP.	0.001uF	50V	B	UMK105B102KW-F	K22178829		1-	A	A1
C 2003	CHIP CAP.	0.001uF	50V	B	GRM155B11H102KA01D	K22178809		75-	A	A1
C 2004	CHIP CAP.	4pF	50V	CH	UMK105CH040CV-F	K22178252		18-	A	A2
C 2004	CHIP CAP.	4pF	50V	CH	UMK105CH040CV-F	K22178252		75-	A	A2
C 2005	CHIP CAP.	47pF	50V	CH	UMK105CH470JV-F	K22178274		1-	A	A2
C 2005	CHIP CAP.	39pF	50V	CH	UMK105CH390JV-F	K22178272		17-	A	A2
C 2005	CHIP CAP.	27pF	50V	CH	GRM1552C1H270JZ01D	K22178222		75-	A	A2
C 2006	CHIP CAP.	4pF	50V	CH	UMK105CH040CV-F	K22178252		18-	A	A1
C 2006	CHIP CAP.	3pF	50V	CJ	UMK105CJ030CV-F	K22178251		75-	A	A1
C 2007	CHIP CAP.	47pF	50V	CH	UMK105CH470JV-F	K22178274		1-	A	A1
C 2007	CHIP CAP.	33pF	50V	CH	UMK105CH330JV-F	K22178270		17-	A	A1
C 2007	CHIP CAP.	27pF	50V	CH	GRM1552C1H270JZ01D	K22178222		75-	A	A1
C 2008	CHIP CAP.	4pF	50V	CH	UMK105CH040CV-F	K22178252		18-	A	A1
C 2008	CHIP CAP.	5pF	50V	CH	UMK105CH050CV-F	K22178253		64-74	A	A1
C 2008	CHIP CAP.	2pF	50V	CK	GRM1554C1H2R0CZ01D	K22178204		86-	A	A1
C 2009	CHIP CAP.	47pF	50V	CH	UMK105CH470JV-F	K22178274		1-	A	A1
C 2009	CHIP CAP.	39pF	50V	CH	UMK105CH390JV-F	K22178272		17-	A	A1
C 2009	CHIP CAP.	33pF	50V	CH	GRM1552C1H330JZ01D	K22178224		75-	A	A1
C 2010	CHIP CAP.	27pF	50V	CH	UMK105CH270JV-F	K22178268		1-	A	A2
C 2010	CHIP CAP.	33pF	50V	CH	GRM1552C1H330JZ01D	K22178224		75-	A	A2
C 2011	CHIP CAP.	47pF	50V	CH	UMK105CH470JV-F	K22178274		1-	A	A1
C 2011	CHIP CAP.	27pF	50V	CH	UMK105CH270JV-F	K22178268		17-	A	A1
C 2011	CHIP CAP.	47pF	50V	CH	GRM1552C1H470JZ01D	K22178228		75-	A	A1
C 2012	CHIP CAP.	100pF	50V	CH	UMK105CH101JV-F	K22178282		1-	A	A1
C 2012	CHIP CAP.	47pF	50V	CH	GRM1552C1H470JZ01D	K22178228		75-	A	A1
C 2016	CHIP CAP.	12pF	50V	CH	UMK105CH120JV-F	K22178260		1-	A	A2
C 2016	CHIP CAP.	7pF	50V	CH	UMK105CH070DV-F	K22178255		17-	A	A2
C 2017	CHIP CAP.	12pF	50V	CH	UMK105CH120JV-F	K22178260		1-	A	A2
C 2017	CHIP CAP.	7pF	50V	CH	UMK105CH070DV-F	K22178255		17-	A	A2
C 2017	CHIP CAP.	33pF	50V	CH	GRM1552C1H330JZ01D	K22178224		75-	A	A2
C 2018	CHIP CAP.	10pF	50V	CH	UMK105CH100DV-F	K22178258		1-	A	A1
C 2018	CHIP CAP.	8pF	50V	CH	GRM1552C1H8R0DZ01D	K22178210		75-	A	A1
C 2019	CHIP CAP.	10pF	50V	CH	UMK105CH100DV-F	K22178258		1-	A	A1
C 2019	CHIP CAP.	22pF	50V	CH	UMK105CH220JV-F	K22178266		75-	A	A1
C 2020	CHIP CAP.	5pF	50V	CH	UMK105CH050CV-F	K22178253		1-	A	A1
C 2020	CHIP CAP.	9pF	50V	CH	GRM1552C1H9R0DZ01D	K22178211		75-	A	A1
C 2021	CHIP CAP.	5pF	50V	CH	UMK105CH050CV-F	K22178253		1-	A	A1
C 2021	CHIP CAP.	27pF	50V	CH	GRM1552C1H270JZ01D	K22178222		75-	A	A1
C 2022	CHIP CAP.	0.01uF	16V	B	GRM36B103K16PT	K22128804		1-	A	A2
C 2022	CHIP CAP.	0.01uF	25V	B	GRM155B11E103KA01D	K22148834		90-	A	A2
C 2023	CHIP CAP.	0.01uF	16V	B	GRM36B103K16PT	K22128804		1-	A	A1
C 2023	CHIP CAP.	0.01uF	25V	B	GRM155B11E103KA01D	K22148834		90-	A	A1
C 2024	CHIP CAP.	0.01uF	16V	B	GRM36B103K16PT	K22128804		1-	A	A1
C 2024	CHIP CAP.	0.01uF	25V	B	GRM155B11E103KA01D	K22148834		90-	A	A1
C 2025	CHIP TA.CAP.	10uF	10V		TEESVA1A106M8R	K78100028		1-	A	A1
C 2026	CHIP CAP.	4pF	50V	CH	UMK105CH040CV-F	K22178252		1-	A	A2
C 2026	CHIP CAP.	1pF	50V	CK	UMK105CK010CV-F	K22178248		19-	A	A2
C 2026	CHIP CAP.	3pF	50V	CJ	UMK105CJ030CV-F	K22178251		75-	A	A2
C 2027	CHIP CAP.	3pF	50V	CJ	UMK105CJ030CV-F	K22178251		1-	A	A1
C 2027	CHIP CAP.	1pF	50V	CK	UMK105CK010CV-F	K22178248		19-	A	A1
C 2027	CHIP CAP.	1.5pF	50V	CK	GRM1554C1H1R5CZ01D	K22178203		75-	A	A1
C 2027	CHIP CAP.	2pF	50V	CK	GRM1554C1H2R0CZ01D	K22178204		83-	A	A1
C 2028	CHIP CAP.	2pF	50V	CK	UMK105CK020CV-F	K22178250		1-	A	A1
C 2028	CHIP CAP.	1pF	50V	CK	UMK105CK010CV-F	K22178248		19-	A	A1
C 2028	CHIP CAP.	2pF	50V	CK	GRM1554C1H2R0CZ01D	K22178204		75-	A	A1
C 2029	CHIP CAP.	0.001uF	50V	B	UMK105B102KW-F	K22178829		1-	A	A1
C 2029	CHIP CAP.	0.001uF	50V	B	GRM155B11H102KA01D	K22178809		75-	A	A1
C 2030	CHIP CAP.	10pF	50V	CH	UMK105CH100DV-F	K22178258		19-74	A	A1
C 2031	CHIP CAP.	0.001uF	50V	B	UMK105B102KW-F	K22178829		1-	A	A1
C 2031	CHIP CAP.	0.001uF	50V	B	GRM155B11H102KA01D	K22178809		75-	A	A1
C 2032	CHIP CAP.	15pF	50V	CH	GRM1552C1H150JZ01D	K22178216		75-	A	B1
C 2033	CHIP TA.CAP.	10uF	10V		TEESVA1A106M8R	K78100028		1-	A	B1
C 2034	CHIP TA.CAP.	10uF	10V		TEESVA1A106M8R	K78100028		1-	A	A1
C 2035	CHIP CAP.	56pF	50V	CH	GRM1552C1H560JD01D	K22178230		104-		
C 2036	CHIP CAP.	0.01uF	16V	B	GRM36B103K16PT	K22128804		1-	A	B1

# PLL Unit

## Parts List

REF	DESCRIPTION	VALUE	V/W	TOL.	MFR'S DESIG	VXSTD P/N	VERS.	LOT	SIDE	LAYADR
C 2036	CHIP CAP.	0.01uF	25V	B	GRM155B11E103KA01D	K22148834		90-	A	B1
C 2037	CHIP CAP.	0.001uF	50V	B	UMK105B102KW-F	K22178829		1-	A	A1
C 2037	CHIP CAP.	0.001uF	50V	B	GRM155B11H102KA01D	K22178809		75-	A	A1
C 2038	CHIP CAP.	0.01uF	50V	B	GRM188B11H103KA01D	K22174823		1-	A	B1
C 2039	CHIP CAP.	0.01uF	50V	B	GRM188B11H103KA01D	K22174823		1-	A	B1
C 2041	CHIP CAP.	2pF	50V	CK	UMK105CK020CV-F	K22178250		1-	A	B1
C 2041	CHIP CAP.	1pF	50V	CK	UMK105CK010CV-F	K22178248		19-	A	B1
C 2041	CHIP CAP.	3pF	50V	CJ	UMK105CJ030CV-F	K22178251		75-	A	B1
C 2042	CHIP CAP.	3pF	50V	CJ	UMK105CJ030CV-F	K22178251		1-	A	B1
C 2042	CHIP CAP.	1pF	50V	CK	UMK105CK010CV-F	K22178248		19-	A	B1
C 2043	CHIP CAP.	0.01uF	16V	B	GRM36B103K16PT	K22128804		1-	A	A1
C 2043	CHIP CAP.	0.01uF	25V	B	GRM155B11E103KA01D	K22148834		90-	A	A1
C 2044	CHIP CAP.	33pF	50V	CH	UMK105CH330JV-F	K22178270		1-	A	A1
C 2044	CHIP CAP.	27pF	50V	CH	GRM1552C1H270JZ01D	K22178222		75-	A	A1
C 2045	CHIP CAP.	33pF	50V	CH	UMK105CH330JV-F	K22178270		1-	A	A1
C 2045	CHIP CAP.	27pF	50V	CH	GRM1552C1H270JZ01D	K22178222		75-	A	A1
C 2046	CHIP CAP.	7pF	50V	CH	UMK105CH070DV-F	K22178255		1-	A	B1
C 2047	CHIP CAP.	7pF	50V	CH	UMK105CH070DV-F	K22178255		1-	A	B1
C 2050	CHIP CAP.	0.001uF	50V	B	UMK105B102KW-F	K22178829		1-	A	B1
C 2050	CHIP CAP.	0.001uF	50V	B	GRM155B11H102KA01D	K22178809		75-	A	B1
C 2051	CHIP CAP.	0.001uF	50V	B	UMK105B102KW-F	K22178829		1-	A	B1
C 2051	CHIP CAP.	0.001uF	50V	B	GRM155B11H102KA01D	K22178809		75-	A	B1
C 2052	CHIP CAP.	0.001uF	50V	B	UMK105B102KW-F	K22178829		1-	A	A1
C 2052	CHIP CAP.	0.001uF	50V	B	GRM155B11H102KA01D	K22178809		75-	A	A1
C 2053	CHIP CAP.	5pF	50V	CH	UMK105CH050CV-F	K22178253		1-	A	A1
C 2053	CHIP CAP.	8pF	50V	CH	GRM1552C1H8R0DZ01D	K22178210		75-	A	A1
C 2054	CHIP CAP.	4pF	50V	CH	UMK105CH040CV-F	K22178252		1-	A	B1
C 2056	CHIP CAP.	0.5pF	50V	CK	UMK105CK0R5CV-F	K22178247		73-	A	B1
C 2056	CHIP CAP.	1pF	50V	CK	UMK105CK010CV-F	K22178248		75-	A	B1
C 2057	CHIP CAP.	0.001uF	50V	B	UMK105B102KW-F	K22178829		1-	A	A1
C 2057	CHIP CAP.	0.001uF	50V	B	GRM155B11H102KA01D	K22178809		75-	A	A1
C 2058	CHIP CAP.	10pF	50V	CH	UMK105CH100DV-F	K22178258		1-	A	B2
C 2059	CHIP CAP.	0.01uF	16V	B	GRM36B103K16PT	K22128804		1-	A	A1
C 2059	CHIP CAP.	0.01uF	25V	B	GRM155B11E103KA01D	K22148834		90-	A	A1
C 2060	CHIP CAP.	0.01uF	16V	B	GRM36B103K16PT	K22128804		1-	A	A1
C 2060	CHIP CAP.	0.01uF	25V	B	GRM155B11E103KA01D	K22148834		90-	A	A1
C 2061	CHIP CAP.	0.001uF	50V	B	UMK105B102KW-F	K22178829		1-	A	A2
C 2061	CHIP CAP.	0.001uF	50V	B	GRM155B11H102KA01D	K22178809		75-	A	A2
C 2062	CHIP CAP.	0.001uF	50V	B	UMK105B102KW-F	K22178829		1-	A	B2
C 2062	CHIP CAP.	0.001uF	50V	B	GRM155B11H102KA01D	K22178809		75-	A	B2
C 2063	CHIP CAP.	0.001uF	50V	B	UMK105B102KW-F	K22178829		1-	B	a1
C 2063	CHIP CAP.	0.001uF	50V	B	GRM155B11H102KA01D	K22178809		75-	B	a1
C 2064	CHIP CAP.	0.001uF	50V	B	UMK105B102KW-F	K22178829		1-	B	a1
C 2064	CHIP CAP.	0.001uF	50V	B	GRM155B11H102KA01D	K22178809		75-	B	a1
C 2065	CHIP CAP.	0.1uF	10V	B	GRM155B11A104KA01D	K22108802		1-	B	a1
C 2066	CHIP CAP.	0.001uF	50V	B	UMK105B102KW-F	K22178829		1-	A	A1
C 2066	CHIP CAP.	0.001uF	50V	B	GRM155B11H102KA01D	K22178809		75-	A	A1
C 2067	CHIP CAP.	270pF	50V	B	UMK105B271KW-F	K22178822		1-	B	a1
C 2067	CHIP CAP.	330pF	50V	B	UMK105B331KW-F	K22178823		14-	B	a1
C 2067	CHIP CAP.	390pF	50V	B	UMK105B391KW-F	K22178824		75-	B	a1
C 2068	CHIP CAP.	0.001uF	50V	B	UMK105B102KW-F	K22178829		1-	A	A1
C 2068	CHIP CAP.	0.001uF	50V	B	GRM155B11H102KA01D	K22178809		75-	A	A1
C 2069	CHIP CAP.	27pF	50V	CH	UMK105CH270JV-F	K22178268		1-	A	B1
C 2069	CHIP CAP.	27pF	50V	CH	GRM1552C1H270JZ01D	K22178222		75-	A	B1
C 2070	CHIP CAP.	22pF	50V	CH	GRM1882C1H220JA01D	K22174219		1-	B	a1
C 2070	CHIP CAP.	82pF	50V	CH	GRM1882C1H820JA01D	K22174233		14-	B	a1
C 2070	CHIP CAP.	39pF	50V	CH	GRM1882C1H390JA01D	K22174225		75-	B	a1
C 2071	CHIP CAP.	390pF	50V	B	UMK105B391KW-F	K22178824		1-	B	a1
C 2071	CHIP CAP.	680pF	50V	B	UMK105B681KW-F	K22178827		14-	B	a1
C 2072	CHIP CAP.	47pF	50V	CH	GRM1882C1H470JA01D	K22174227		1-	B	a1
C 2072	CHIP CAP.	68pF	50V	CH	GRM1882C1H680JA01D	K22174231		14-	B	a1
C 2072	CHIP CAP.	33pF	50V	CH	GRM1882C1H330JA01D	K22174223		19-	B	a1
C 2072	CHIP CAP.	120pF	50V	CH	GRM1882C1H121JA01D	K22174237		75-	B	a1
C 2073	CHIP CAP.	0.001uF	50V	B	UMK105B102KW-F	K22178829		1-	A	A1
C 2073	CHIP CAP.	0.001uF	50V	B	GRM155B11H102KA01D	K22178809		75-	A	A1
C 2074	CHIP CAP.	0.001uF	50V	B	UMK105B102KW-F	K22178829		1-	B	a1
C 2074	CHIP CAP.	0.001uF	50V	B	GRM155B11H102KA01D	K22178809		75-	B	a1
C 2075	CHIP CAP.	390pF	50V	B	UMK105B391KW-F	K22178824		1-	B	a1
C 2075	CHIP CAP.	680pF	50V	B	UMK105B681KW-F	K22178827		14-	B	a1
C 2075	CHIP CAP.	560pF	50V	B	UMK105B561KW-F	K22178826		75-	B	a1
C 2076	CHIP CAP.	0.001uF	50V	B	UMK105B102KW-F	K22178829		1-	A	A1
C 2076	CHIP CAP.	0.001uF	50V	B	GRM155B11H102KA01D	K22178809		75-	A	A1
C 2077	CHIP CAP.	68pF	50V	CH	UMK105CH680JV-F	K22178278		1-	B	a1

# PLL Unit

## Parts List

REF	DESCRIPTION	VALUE	V/W	TOL.	MFR'S DESIG	VXSTD P/N	VERS.	LOT	SIDE	LAYADR
C 2077	CHIP CAP.	22pF	50V	CH	UMK105CH220JV-F	K22178266		14-	B	a1
C 2077	CHIP CAP.	27pF	50V	CH	UMK105CH270JV-F	K22178268		19-	B	a1
C 2077	CHIP CAP.	220pF	50V	CH	GRM1882C1H221JA01D	K22174243		75-	B	a1
C 2078	CHIP TA.CAP.	4.7uF	16V		TEESVA1C475M8R	K78120031		1-	B	b1
C 2079	CHIP CAP.	0.01uF	16V	B	GRM36B103K16PT	K22128804		1-	B	b1
C 2079	CHIP CAP.	0.01uF	25V	B	GRM155B11E103KA01D	K22148834		90-	B	b1
C 2080	CHIP CAP.	0.01uF	16V	B	GRM36B103K16PT	K22128804		1-	B	b2
C 2080	CHIP CAP.	0.01uF	25V	B	GRM155B11E103KA01D	K22148834		90-	B	b2
C 2081	CHIP CAP.	390pF	50V	B	UMK105B391KW-F	K22178824		1-	B	a1
C 2081	CHIP CAP.	270pF	50V	B	UMK105B271KW-F	K22178822		75-	B	a1
C 2082	CHIP TA.CAP.	10uF	10V		TEESVA1A106M8R	K78100028		1-	B	b2
C 2083	CHIP CAP.	0.01uF	16V	B	GRM36B103K16PT	K22128804		75-	B	a1
C 2083	CHIP CAP.	0.01uF	25V	B	GRM155B11E103KA01D	K22148834		90-	B	a1
C 2084	CHIP CAP.	0.001uF	50V	B	UMK105B102KW-F	K22178829		1-	B	a1
C 2084	CHIP CAP.	0.001uF	50V	B	GRM155B11H102KA01D	K22178809		75-	B	a1
C 2085	CHIP CAP.	0.1uF	16V	B	GRM188B11C104KA01D	K22124805		1-	B	a1
C 2085	CHIP TA.CAP.	4.7uF	16V		TEESVA1C475M8R	K78120031		75-	B	a1
C 2086	CHIP TA.CAP.	4.7uF	16V		TEESVA1C475M8R	K78120031		1-	B	a1
C 2087	CHIP CAP.	0.01uF	16V	B	GRM36B103K16PT	K22128804		1-	B	b1
C 2087	CHIP CAP.	0.01uF	25V	B	GRM155B11E103KA01D	K22148834		90-	B	b1
C 2088	CHIP CAP.	0.01uF	16V	B	GRM36B103K16PT	K22128804		1-	B	b1
C 2088	CHIP CAP.	0.1uF	10V	B	GRM155B11A104KA01D	K22108802		14-	B	b1
C 2090	CHIP CAP.	22pF	50V	CH	GRM1882C1H220JA01D	K22174219		1-	B	a1
C 2090	CHIP CAP.	5pF	50V	CH	GRM1882C1H5R0CZ01D	K22174206		14-	B	a1
C 2090	CHIP CAP.	47pF	50V	CH	GRM1882C1H470JA01D	K22174227		19-	B	a1
C 2090	CHIP CAP.	47pF	50V	CH	GRM1552C1H470JZ01D	K22178228		75-	B	a1
C 2091	CHIP CAP.	0.01uF	50V	B	GRM188B11H103KA01D	K22174823		1-	B	a2
C 2092	CHIP CAP.	0.001uF	50V	B	UMK105B102KW-F	K22178829		1-	B	a1
C 2092	CHIP CAP.	100pF	50V	CH	GRM1552C1H101JD01D	K22178236		75-	B	a1
C 2093	CHIP CAP.	0.001uF	50V	B	UMK105B102KW-F	K22178829		1-	B	b1
C 2093	CHIP CAP.	0.001uF	50V	B	GRM155B11H102KA01D	K22178809		75-	B	b1
C 2094	CHIP CAP.	0.01uF	50V	B	GRM188B11H103KA01D	K22174823		1-	B	a1
C 2095	CHIP CAP.	120pF	50V	CH	UMK105CH121JV-F	K22178284		1-	B	b1
C 2096	CHIP TA.CAP.	1uF	16V		TMCSA1C105MTR	K78120023		1-	B	a1
C 2097	CHIP CAP.	180pF	25V	CH	GRM36CH181J25PT	K22148201		1-	B	b1
C 2097	CHIP CAP.	180pF	25V	CH	TMK105CH181JV-F	K22148244		75-	B	b1
C 2099	CHIP CAP.	0.1uF	16V	B	GRM188B11C104KA01D	K22124805		1-	B	a1
C 2099	CHIP CAP.	0.01uF	16V	B	GRM36B103K16PT	K22128804		75-	B	a1
C 2099	CHIP CAP.	0.01uF	25V	B	GRM155B11E103KA01D	K22148834		90-	B	a1
C 2100	CHIP CAP.	120pF	50V	CH	UMK105CH121JV-F	K22178284		1-	B	b1
C 2101	CHIP CAP.	0.01uF	50V	B	GRM188B11H103KA01D	K22174823		1-	B	a2
C 2101	CHIP CAP.	0.01uF	16V	B	GRM36B103K16PT	K22128804		75-	B	a2
C 2101	CHIP CAP.	0.01uF	25V	B	GRM155B11E103KA01D	K22148834		90-	B	a2
C 2102	CHIP TA.CAP.	10uF	10V		TEESVA1A106M8R	K78100028		1-	B	a2
C 2103	CHIP CAP.	0.01uF	16V	B	GRM36B103K16PT	K22128804		1-	A	A1
C 2103	CHIP CAP.	0.01uF	25V	B	GRM155B11E103KA01D	K22148834		90-	A	A1
C 2104	CHIP CAP.	22pF	50V	CH	UMK105CH220JV-F	K22178266		1-	B	b1
C 2105	CHIP CAP.	0.001uF	50V	B	UMK105B102KW-F	K22178829		1-	A	B1
C 2105	CHIP CAP.	0.001uF	50V	B	GRM155B11H102KA01D	K22178809		75-	A	B1
C 2106	CHIP CAP.	0.01uF	16V	B	GRM36B103K16PT	K22128804		1-	A	B1
C 2106	CHIP CAP.	0.01uF	25V	B	GRM155B11E103KA01D	K22148834		90-	A	B1
C 2107	CHIP CAP.	0.01uF	16V	B	GRM36B103K16PT	K22128804		1-	B	a1
C 2107	CHIP CAP.	0.01uF	25V	B	GRM155B11E103KA01D	K22148834		90-	B	a1
C 2108	CHIP CAP.	15pF	50V	CH	UMK105CH150JV-F	K22178262		1-	A	B1
C 2109	CHIP CAP.	47pF	50V	CH	UMK105CH470JV-F	K22178274		1-	A	B1
C 2109	CHIP CAP.	47pF	50V	CH	GRM1552C1H470JZ01D	K22178228		75-	A	B1
C 2110	CHIP CAP.	27pF	50V	CH	UMK105CH270JV-F	K22178268		1-	A	B1
C 2110	CHIP CAP.	27pF	50V	CH	GRM1552C1H270JZ01D	K22178222		75-	A	B1
C 2111	CHIP CAP.	27pF	50V	CH	UMK105CH270JV-F	K22178268		1-	A	B1
C 2111	CHIP CAP.	27pF	50V	CH	GRM1552C1H270JZ01D	K22178222		75-	A	B1
C 2112	CHIP CAP.	15pF	50V	CH	UMK105CH150JV-F	K22178262		1-	A	B1
C 2113	CHIP CAP.	0.001uF	50V	B	UMK105B102KW-F	K22178829		1-	A	A1
C 2113	CHIP CAP.	0.001uF	50V	B	GRM155B11H102KA01D	K22178809		75-	A	A1
C 2114	CHIP CAP.	4pF	50V	CH	UMK105CH040CV-F	K22178252		1-	A	B1
C 2115	CHIP CAP.	12pF	50V	CH	UMK105CH120JV-F	K22178260		1-	A	B1
C 2116	CHIP CAP.	4pF	50V	CH	UMK105CH040CV-F	K22178252		1-	A	B1
C 2128	CHIP CAP.	0.001uF	50V	B	UMK105B102KW-F	K22178829		1-	A	B1
C 2128	CHIP CAP.	0.001uF	50V	B	GRM155B11H102KA01D	K22178809		75-	A	B1
C 2129	CHIP CAP.	3pF	50V	CJ	UMK105CJ030CV-F	K22178251		1-	A	A1
C 2129	CHIP CAP.	2pF	50V	CK	UMK105CK020CV-F	K22178250		17-	A	A1
C 2129	CHIP CAP.	1pF	50V	CK	UMK105CK010CV-F	K22178248		75-	A	A1
C 2130	CHIP CAP.	1pF	50V	CK	UMK105CK010CV-F	K22178248		75-	A	A1
C 2131	CHIP CAP.	0.5pF	50V	CK	UMK105CK0R5CV-F	K22178247		75-	A	A2

# PLL Unit

## Parts List

REF	DESCRIPTION	VALUE	V/W	TOL.	MFR'S DESIG	VXSTD P/N	VERS.	LOT	SIDE	LAYADR
C 2132	CHIP CAP.	100pF	50V	CH	UMK105CH101JV-F	K22178282		1-13	B	a1
C 2133	CHIP CAP.	0.01uF	16V	B	GRM36B103K16PT	K22128804		1-	B	b1
C 2133	CHIP CAP.	0.01uF	25V	B	GRM155B11E103KA01D	K22148834		90-	B	b1
C 2134	CHIP CAP.	0.01uF	16V	B	GRM36B103K16PT	K22128804		1-	B	a1
C 2134	CHIP CAP.	0.01uF	25V	B	GRM155B11E103KA01D	K22148834		90-	B	a1
C 2136	CHIP CAP.	100pF	50V	CH	GRM1552C1H101JD01D	K22178236		75-	B	a1
C 2137	CHIP CAP.	820pF	50V	B	UMK105B821KW-F	K22178828		19-	B	a1
C 2137	CHIP CAP.	470pF	50V	B	GRM155B11H471KA01D	K22178805		75-	B	a1
C 2138	CHIP CAP.	820pF	50V	B	UMK105B821KW-F	K22178828		19-	B	a1
C 2138	CHIP CAP.	470pF	50V	B	GRM155B11H471KA01D	K22178805		75-	B	a1
C 2139	CHIP CAP.	0.0012uF	50V	B	UMK105B122KW-F	K22178830		19-74		
C 2140	CHIP CAP.	1pF	50V	CK	UMK105CK010CV-F	K22178248		61-63	B	a1
C 2140	CHIP CAP.	0.01uF	16V	B	GRM36B103K16PT	K22128804		75-	B	a1
C 2140	CHIP CAP.	0.01uF	25V	B	GRM155B11E103KA01D	K22148834		90-	B	a1
C 2141	CHIP TA.CAP.	4.7uF	16V		TEESVA1C475M8R	K78120031		75-	B	a2
D 2001	DIODE				HVC362TRF-E	G2070636		1-	A	A2
D 2001	DIODE				1SV282(TPH3.F)	G2070778		17-	A	A2
D 2001	DIODE				1SV325(TPH3.F)	G2070848		75-	A	A2
D 2002	DIODE				HVC362TRF-E	G2070636		1-	A	A1
D 2002	DIODE				1SV282(TPH3.F)	G2070778		17-	A	A1
D 2002	DIODE				1SV325(TPH3.F)	G2070848		75-	A	A1
D 2003	DIODE				HVC362TRF-E	G2070636		1-	A	A1
D 2003	DIODE				1SV282(TPH3.F)	G2070778		17-	A	A1
D 2003	DIODE				1SV325(TPH3.F)	G2070848		75-	A	A1
D 2004	DIODE				HVC362TRF-E	G2070636		1-	A	A2
D 2004	DIODE				1SV325(TPH3.F)	G2070848		75-	A	A2
D 2005	DIODE				HVC362TRF-E	G2070636		1-	A	A1
D 2005	DIODE				1SV325(TPH3.F)	G2070848		75-	A	A1
D 2006	DIODE				HVC362TRF-E	G2070636		1-	A	A1
D 2006	DIODE				1SV325(TPH3.F)	G2070848		75-	A	A1
D 2007	DIODE				1SV282(TPH3.F)	G2070778		1-	A	A2
D 2008	DIODE				1SV281(TPH3.F)	G2070620		1-	A	A2
D 2009	DIODE				1SV286(TPH3.F)	G2070610		1-	A	B2
D 2009	DIODE				1SV284(TPH3.F)	G2070622		75-	A	B2
D 2010	DIODE				DAP236U T106	G2070592		1-	A	A1
D 2011	DIODE				HSC277TRF-E	G2070584		1-	A	A1
D 2012	DIODE				DAP222-TL	G2070432		1-	A	B2
D 2013	DIODE				DAP236U T106	G2070592		1-	A	B1
D 2014	DIODE				HSC277TRF-E	G2070584		1-	A	B1
D 2015	DIODE				HSC277TRF-E	G2070584		1-	A	A1
D 2016	DIODE				HSC277TRF-E	G2070584		1-	A	A1
D 2017	DIODE				DAP222-TL	G2070432		1-	A	B1
D 2018	DIODE				DAN222 TL	G2070174		75-	B	a2
J 2001	CONNECTOR				9230B-1-12Z003-T	P0090896		1-	B	b1
J 2002	CONNECTOR				9230B-1-12Z003-T	P0090896		1-	B	a2
L 2001	M.RFC	4.7uH			LK1608 4R7K-T	L1690688		1-	A	A2
L 2002	M.RFC	4.7uH			LK1608 4R7K-T	L1690688		1-	A	A1
L 2003	M.RFC	4.7uH			LK1608 4R7K-T	L1690688		1-	A	A1
L 2004	M.RFC	4.7uH			LK1608 4R7K-T	L1690688		1-	A	A2
L 2005	M.RFC	4.7uH			LK1608 4R7K-T	L1690688		1-	A	A1
L 2006	M.RFC	4.7uH			LK1608 4R7K-T	L1690688		1-	A	A1
L 2007	M.RFC	1uH			LK1608 1R0K-T	L1690687		1-	A	B1
L 2008	M.RFC	1uH			LK1608 1R0K-T	L1690687		1-	A	B1
L 2009	M.RFC	0.01uH			HK1608 10NJ-T	L1690516		1-	A	B1
L 2009	M.RFC	0.015uH			HK1608 15NJ-T	L1690518		77-	A	B1
L 2010	COIL				E2 0.4-2.0-5.5T-L	L0022630		1-	A	A1
L 2010	COIL	0.038uH			AS050630-38N	L0022818		75-	A	A1
L 2011	COIL				E2 0.45-1.4-2.5T-L	L0022618		1-	A	B1
L 2011	COIL	0.009uH			AS050325-9R0NK	L0022612		73-	A	B1
L 2012	M.RFC	4.7uH			LK1608 4R7K-T	L1690688		1-	A	A2
L 2013	M.RFC	4.7uH			LK1608 4R7K-T	L1690688		1-	A	B2
L 2014	M.RFC	2.2uH			LK1608 2R2K-T	L1690634		1-	B	a1
L 2014	M.RFC	1.2uH			LK1608 1R2K-T	L1690845		14-	B	a1
L 2015	M.RFC	2.2uH			LK1608 2R2K-T	L1690634		1-	B	a1
L 2015	M.RFC	1.8uH			LK1608 1R8K-T	L1690847		14-	B	a1
L 2015	M.RFC	1uH			LK1608 1R0K-T	L1690687		75-	B	a1
L 2016	M.RFC	1.8uH			LK1608 1R8K-T	L1690847		1-	B	a1
L 2016	M.RFC	0.68uH			LK1608 R68K-T	L1690416		75-	B	a1
L 2017	M.RFC	0.082uH			HK1608 82NJ-T	L1690527		1-	A	B1
L 2018	M.RFC	10uH			LK1608 100K-T	L1690689		1-	B	a1
L 2019	M.RFC	10uH			LK1608 100K-T	L1690689		1-	B	b1
L 2020	M.RFC	0.47uH			LK1608 R47K-T	L1690414		1-	B	b1
L 2021	M.RFC	0.47uH			LK1608 R47K-T	L1690414		1-	B	b1

# PLL Unit

## Parts List

REF	DESCRIPTION	VALUE	V/W	TOL.	MFR'S DESIG	VXSTD P/N	VERS.	LOT	SIDE	LAYADR
L 2022	M.RFC	0.047uH			HK1608 47NJ-T	L1690524		1-	A	B1
L 2023	M.RFC	1.8uH			LK1608 1R8K-T	L1690847		1-	B	b1
L 2024	M.RFC	0.082uH			HK1608 82NJ-T	L1690527		1-	A	B1
L 2025	M.RFC	0.047uH			HK1608 47NJ-T	L1690524		1-	A	B1
L 2026	M.RFC	0.018uH			HK1608 18NJ-T	L1690519		1-	A	B1
L 2027	M.RFC	0.018uH			HK1608 18NJ-T	L1690519		1-	A	B1
L 2028	M.RFC	0.33uH			LK1608 R33K-T	L1690412		19-	A	A1
L 2029	M.RFC	2.2uH			LK1608 2R2K-T	L1690634		19-	B	a1
L 2029	M.RFC	1uH			LK1608 1R0K-T	L1690687		75-	B	a1
L 2030	M.RFC	10uH			LK1608 100K-T	L1690689		75-	B	a1
L 2031	M.RFC	10uH			LK1608 100K-T	L1690689		75-	B	a2
L 2032	M.RFC	0.01uH			HK1608 10NJ-T	L1690516		104-		
Q 2001	TRANSISTOR				DTC124EU T106	G3070045		1-	A	A2
Q 2002	TRANSISTOR				DTC124EU T106	G3070045		1-	A	A2
Q 2003	TRANSISTOR				DTC124EU T106	G3070045		1-	A	A1
Q 2004	FET				2SK210-GR(TE85R.F)	G3802107G		1-	A	A2
Q 2005	FET				2SK210-GR(TE85R.F)	G3802107G		1-	A	A1
Q 2006	FET				2SK210-GR(TE85R.F)	G3802107G		1-	A	A1
Q 2007	TRANSISTOR				2SC4154-T111-1E	G3341548E		1-	A	A1
Q 2007	TRANSISTOR				2SC4081 T106	G3340818		98-	A	A1
Q 2009	TRANSISTOR				2SC5374-TL	G3353748		1-	A	A1
Q 2010	TRANSISTOR				2SC5374-TL	G3353748		1-	A	B1
Q 2011	TRANSISTOR				2SC5374-TL	G3353748		1-	A	B1
Q 2012	TRANSISTOR				DTC124EU T106	G3070045		1-	A	A1
Q 2013	TRANSISTOR				DTC124EU T106	G3070045		1-	A	B1
Q 2016	IC				AD9850BRSZ-REEL	G1092567		1-	B	b1
Q 2018	IC				BU4094BCFV-E2	G1093527		1-	B	b2
Q 2019	TRANSISTOR				2SC4400-4-TL	G3344008D		75-	B	a1
Q 2020	TRANSISTOR				2SC4400-4-TL	G3344008D		1-	B	b1
Q 2021	IC				FQ7925	G1091710		1-	B	a1
Q 2021	IC				ADF4116BRU(TAPE)	G1093581		75-	B	a1
Q 2022	IC				UPC2713T-E3	G1092862		1-	A	A1
Q 2022	IC				UPC2710TB-E3	G1093932		19-	A	A1
Q 2023	IC				UPC1688G-T1-A	G1092286		1-	B	a1
Q 2023	IC				TA4002F(TE85L.F)	G1092813		19-	B	a1
Q 2024	TRANSISTOR				DTC124EU T106	G3070045		75-	B	a1
Q 2025	TRANSISTOR				DTC124EU T106	G3070045		75-	B	a1
Q 2026	TRANSISTOR				DTC124EU T106	G3070045		75-	B	a1
Q 2027	TRANSISTOR				DTC124EU T106	G3070045		75-	B	a2
R 2001	CHIPRES.	47	1/16W	5%	RMC1/16S 470JTH	J24189009		1-	A	A2
R 2002	CHIPRES.	47	1/16W	5%	RMC1/16S 470JTH	J24189009		1-	A	A2
R 2003	CHIPRES.	47	1/16W	5%	RMC1/16S 470JTH	J24189009		1-	A	A1
R 2004	CHIPRES.	470k	1/16W	5%	RMC1/16S 474JTH	J24189057		1-	A	A2
R 2004	CHIPRES.	100k	1/16W	5%	RMC1/16S 104JTH	J24189049		75-	A	A2
R 2005	CHIPRES.	470k	1/16W	5%	RMC1/16S 474JTH	J24189057		1-	A	A1
R 2005	CHIPRES.	100k	1/16W	5%	RMC1/16S 104JTH	J24189049		75-	A	A1
R 2006	CHIPRES.	470k	1/16W	5%	RMC1/16S 474JTH	J24189057		1-	A	A1
R 2006	CHIPRES.	100k	1/16W	5%	RMC1/16S 104JTH	J24189049		75-	A	A1
R 2007	CHIPRES.	68	1/16W	5%	RMC1/16S 680JTH	J24189011		1-	A	A2
R 2007	CHIPRES.	150	1/16W	5%	RMC1/16S 151JTH	J24189015		75-	A	A2
R 2008	CHIPRES.	68	1/16W	5%	RMC1/16S 680JTH	J24189011		1-	A	A2
R 2008	CHIPRES.	150	1/16W	5%	RMC1/16S 151JTH	J24189015		75-	A	A2
R 2009	CHIPRES.	68	1/16W	5%	RMC1/16S 680JTH	J24189011		1-	A	A1
R 2009	CHIPRES.	150	1/16W	5%	RMC1/16S 151JTH	J24189015		75-	A	A1
R 2010	CHIPRES.	47	1/16W	5%	RMC1/16S 470JTH	J24189009		1-	A	A1
R 2010	CHIPRES.	100	1/16W	5%	RMC1/16S 101JTH	J24189013		19-	A	A1
R 2011	CHIPRES.	1k	1/16W	5%	RMC1/16S 102JTH	J24189025		1-	A	A1
R 2011	CHIPRES.	470	1/16W	5%	RMC1/16S 471JTH	J24189021		19-	A	A1
R 2011	CHIPRES.	1k	1/16W	5%	RMC1/16S 102JTH	J24189025		75-	A	A1
R 2012	CHIPRES.	2.2k	1/16W	5%	RMC1/16S 222JTH	J24189029		1-	B	a1
R 2013	CHIPRES.	100	1/16W	5%	RMC1/16S 101JTH	J24189013		1-	A	A1
R 2014	CHIPRES.	470	1/16W	5%	RMC1/16S 471JTH	J24189021		1-	A	B1
R 2014	CHIPRES.	680	1/16W	5%	RMC1/16S 681JTH	J24189023		75-	A	B1
R 2015	CHIPRES.	100	1/16W	5%	RMC1/16S 101JTH	J24189013		1-	A	B1
R 2016	CHIPRES.	470	1/16W	5%	RMC1/16S 471JTH	J24189021		1-	A	B1
R 2017	CHIPRES.	2.2k	1/16W	5%	RMC1/16S 222JTH	J24189029		1-	A	A1
R 2018	CHIPRES.	68k	1/16W	5%	RMC1/16S 683JTH	J24189047		1-	A	B1
R 2018	CHIPRES.	47k	1/16W	5%	RMC1/16S 473JTH	J24189045		19-	A	B1
R 2019	CHIPRES.	4.7k	1/16W	5%	RMC1/16S 472JTH	J24189033		1-	A	A1
R 2020	CHIPRES.	4.7k	1/16W	5%	RMC1/16S 472JTH	J24189033		1-	A	B1
R 2021	CHIPRES.	10k	1/16W	5%	RMC1/16S 103JTH	J24189037		1-	A	A1
R 2021	CHIPRES.	6.8k	1/16W	5%	RMC1/16S 682JTH	J24189035		19-	A	A1
R 2022	CHIPRES.	10k	1/16W	5%	RMC1/16S 103JTH	J24189037		1-	A	B1

# PLL Unit

## Parts List

REF	DESCRIPTION	VALUE	V/W	TOL.	MFR'S DESIG	VXSTD P/N	VERS.	LOT	SIDE	LAYADR
R 2022	CHIPRES.	6.8k	1/16W	5%	RMC1/16S 682JTH	J24189035		19-	A	B1
R 2023	CHIPRES.	560	1/16W	5%	RMC1/16S 561JTH	J24189022		1-	A	B1
R 2024	CHIPRES.	100	1/16W	5%	RMC1/16S 101JTH	J24189013		1-	A	B1
R 2025	CHIPRES.	1.5k	1/16W	5%	RMC1/16S 152JTH	J24189027		1-	A	B1
R 2026	CHIPRES.	1.5k	1/16W	5%	RMC1/16S 152JTH	J24189027		1-	A	B1
R 2027	CHIPRES.	1.5k	1/16W	5%	RMC1/16S 152JTH	J24189027		1-	A	B1
R 2028	CHIPRES.	2.2k	1/16W	5%	RMC1/16S 222JTH	J24189029		1-	B	b1
R 2029	CHIPRES.	47	1/16W	5%	RMC1/16S 470JTH	J24189009		1-	A	A2
R 2030	CHIPRES.	47	1/16W	5%	RMC1/16S 470JTH	J24189009		1-	A	B2
R 2031	CHIPRES.	6.8k	1/16W	5%	RMC1/16S 682JTH	J24189035		75-	A	A1
R 2032	CHIPRES.	100	1/16W	5%	RMC1/16S 101JTH	J24189013		1-	B	a1
R 2032	CHIPRES.	47	1/16W	5%	RMC1/16S 470JTH	J24189009		14-	B	a1
R 2032	CHIPRES.	100	1/16W	5%	RMC1/16S 101JTH	J24189013		19-	B	a1
R 2041	CHIPRES.	470	1/16W	5%	RMC1/16S 471JTH	J24189021		1-	B	b1
R 2041	CHIPRES.	100	1/16W	5%	RMC1/16S 101JTH	J24189013		75-	B	b1
R 2043	CHIPRES.	470	1/16W	5%	RMC1/16S 471JTH	J24189021		1-	B	b1
R 2043	CHIPRES.	100	1/16W	5%	RMC1/16S 101JTH	J24189013		75-	B	b1
R 2044	CHIPRES.	470	1/16W	5%	RMC1/16S 471JTH	J24189021		1-	B	b1
R 2044	CHIPRES.	100	1/16W	5%	RMC1/16S 101JTH	J24189013		75-	B	b1
R 2045	CHIPRES.	470	1/16W	5%	RMC1/16S 471JTH	J24189021		1-	B	b2
R 2045	CHIPRES.	100	1/16W	5%	RMC1/16S 101JTH	J24189013		75-	B	b2
R 2047	CHIPRES.	470	1/16W	5%	RMC1/16S 471JTH	J24189021		1-	B	b1
R 2047	CHIPRES.	100	1/16W	5%	RMC1/16S 101JTH	J24189013		75-	B	b1
R 2049	CHIPRES.	470	1/16W	5%	RMC1/16S 471JTH	J24189021		1-	B	b1
R 2049	CHIPRES.	100	1/16W	5%	RMC1/16S 101JTH	J24189013		75-	B	b1
R 2052	CHIPRES.	27	1/16W	5%	RMC1/16S 270JTH	J24189006		1-	B	a1
R 2053	CHIPRES.	2.2k	1/16W	5%	RMC1/16S 222JTH	J24189029		1-	B	b1
R 2054	CHIPRES.	6.8k	1/16W	5%	RMC1/16S 682JTH	J24189035		1-	B	b1
R 2055	CHIPRES.	220k	1/16W	5%	RMC1/16S 224JTH	J24189053		1-	B	b1
R 2056	CHIPRES.	1k	1/16W	5%	RMC1/16S 102JTH	J24189025		1-	A	A1
R 2056	CHIPRES.	47	1/16W	5%	RMC1/16S 470JTH	J24189009		75-	A	A1
R 2056	CHIPRES.	220	1/16W	5%	RMC1/16S 221JTH	J24189017		77-	A	A1
R 2057	CHIPRES.	1k	1/16W	5%	RMC1/16S 102JTH	J24189025		1-	B	a2
R 2058	CHIPRES.	1M	1/16W	5%	RMC1/16S 105JTH	J24189061		1-74	B	a2
R 2059	CHIPRES.	1k	1/16W	5%	RMC1/16S 102JTH	J24189025		1-	B	a1
R 2060	CHIPRES.	470	1/16W	5%	RMC1/16S 471JTH	J24189021		1-	B	a1
R 2060	CHIPRES.	33k	1/16W	5%	RMC1/16S 333JTH	J24189043		75-	B	a1
R 2061	CHIPRES.	470	1/16W	5%	RMC1/16S 471JTH	J24189021		1-	B	a1
R 2062	CHIPRES.	470	1/16W	5%	RMC1/16S 471JTH	J24189021		1-	B	a1
R 2062	CHIPRES.	270	1/16W	5%	RMC1/16S 271JTH	J24189018		14-	B	a1
R 2063	CHIPRES.	470	1/16W	5%	RMC1/16S 471JTH	J24189021		1-74	B	a1
R 2064	CHIPRES.	3.3k	1/16W	5%	RMC1/16S 332JTH	J24189031		1-	B	a1
R 2065	CHIPRES.	0	1/16W	5%	RMC1/16S JPTH	J24189070		1-74	B	a1
R 2067	CHIPRES.	10	1/16W	5%	RMC1/16S 100JTH	J24189001		1-	A	A1
R 2067	CHIPRES.	100	1/16W	5%	RMC1/16S 101JTH	J24189013		19-	A	A1
R 2067	CHIPRES.	10	1/16W	5%	RMC1/16S 100JTH	J24189001		77-	A	A1
R 2068	CHIPRES.	1k	1/16W	5%	RMC1/16S 102JTH	J24189025		1-	B	a1
R 2069	CHIPRES.	1k	1/16W	5%	RMC1/16S 102JTH	J24189025		1-	B	a1
R 2070	CHIPRES.	2.2k	1/16W	5%	RMC1/16S 222JTH	J24189029		1-	A	B1
R 2071	CHIPRES.	470	1/16W	5%	RMC1/16S 471JTH	J24189021		1-	B	a1
R 2071	CHIPRES.	47	1/16W	5%	RMC1/16S 470JTH	J24189009		19-	B	a1
R 2073	CHIPRES.	47	1/16W	5%	RMC1/16S 470JTH	J24189009		1-	B	a2
R 2074	CHIPRES.	3.3k	1/16W	5%	RMC1/16S 332JTH	J24189031		1-	A	A1
R 2075	CHIPRES.	47k	1/16W	5%	RMC1/16S 473JTH	J24189045		1-	A	B1
R 2076	CHIPRES.	47k	1/16W	5%	RMC1/16S 473JTH	J24189045		1-	A	B1
R 2077	CHIPRES.	47k	1/16W	5%	RMC1/16S 473JTH	J24189045		1-	A	B1
R 2078	CHIPRES.	47	1/16W	5%	RMC1/16S 470JTH	J24189009		1-	A	A1
R 2079	CHIPRES.	10	1/16W	5%	RMC1/16S 100JTH	J24189001		1-	B	a1
R 2080	CHIPRES.	3.3k	1/16W	5%	RMC1/16S 332JTH	J24189031		1-	A	B1
R 2081	CHIPRES.	10	1/16W	5%	RMC1/16S 100JTH	J24189001		1-	B	a2
R 2081	CHIPRES.	100	1/16W	5%	RMC1/16S 101JTH	J24189013		75-	B	a2
R 2082	CHIPRES.	100	1/16W	5%	RMC1/16S 101JTH	J24189013		1-	A	B1
R 2083	CHIPRES.	100	1/16W	5%	RMC1/16S 101JTH	J24189013		1-	A	B2
R 2083	CHIPRES.	100k	1/16W	5%	RMC1/16S 104JTH	J24189049		75-	A	B2
R 2084	CHIPRES.	100	1/16W	5%	RMC1/16S 101JTH	J24189013		1-	B	a2
R 2085	CHIPRES.	100	1/16W	5%	RMC1/16S 101JTH	J24189013		1-	B	a2
R 2086	CHIPRES.	100	1/16W	5%	RMC1/16S 101JTH	J24189013		1-	B	a2
R 2087	CHIPRES.	100	1/16W	5%	RMC1/16S 101JTH	J24189013		1-74		
R 2088	CHIPRES.	47	1/16W	5%	RMC1/16S 470JTH	J24189009		19-74		
R 2089	CHIPRES.	100	1/16W	5%	RMC1/16S 101JTH	J24189013		19-74		
T 2001	COIL 05RF				CS-4N 5203-JPS-076	L0022507		1-	A	A2
T 2001	COIL 05RF				CS-4N 5203-G001	L0023019		93-	A	A2
T 2002	COIL 05RF				CS-4N 5203-JPS-077	L0022508		1-	A	A1

# PLL Unit

## Parts List

REF	DESCRIPTION	VALUE	V/W	TOL.	MFR'S DESIG	VXSTD P/N	VERS.	LOT	SIDE	LAYADR
T 2002	COIL 05RF				CS-4N 5203-G002	L0023020		93-	A	A1
T 2003	COIL 05RF				CS-4N 5203-JPS-078	L0022509		1-	A	A1
T 2003	COIL 05RF				CS-4N 5203-G003	L0023021		93-	A	A1
	SHIELD CASE PLL					RA0271100		1-		
	SHIELD CASE COVER					RA02712A0		1-		

# *PLL Unit*

*Note:*



Circuit Diagram

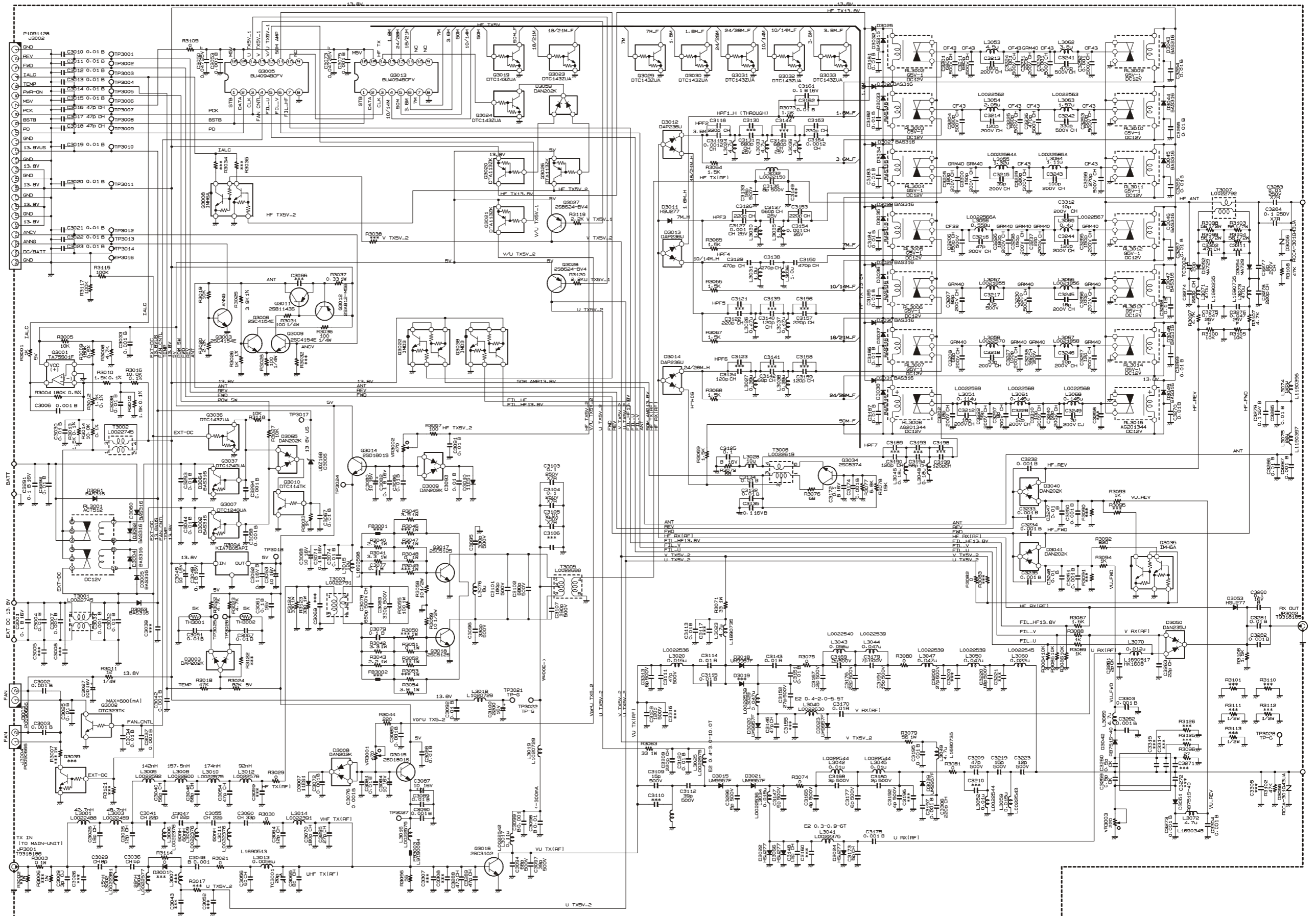

*PA Unit (Lot. 1 ~ 3)*

*Note:*

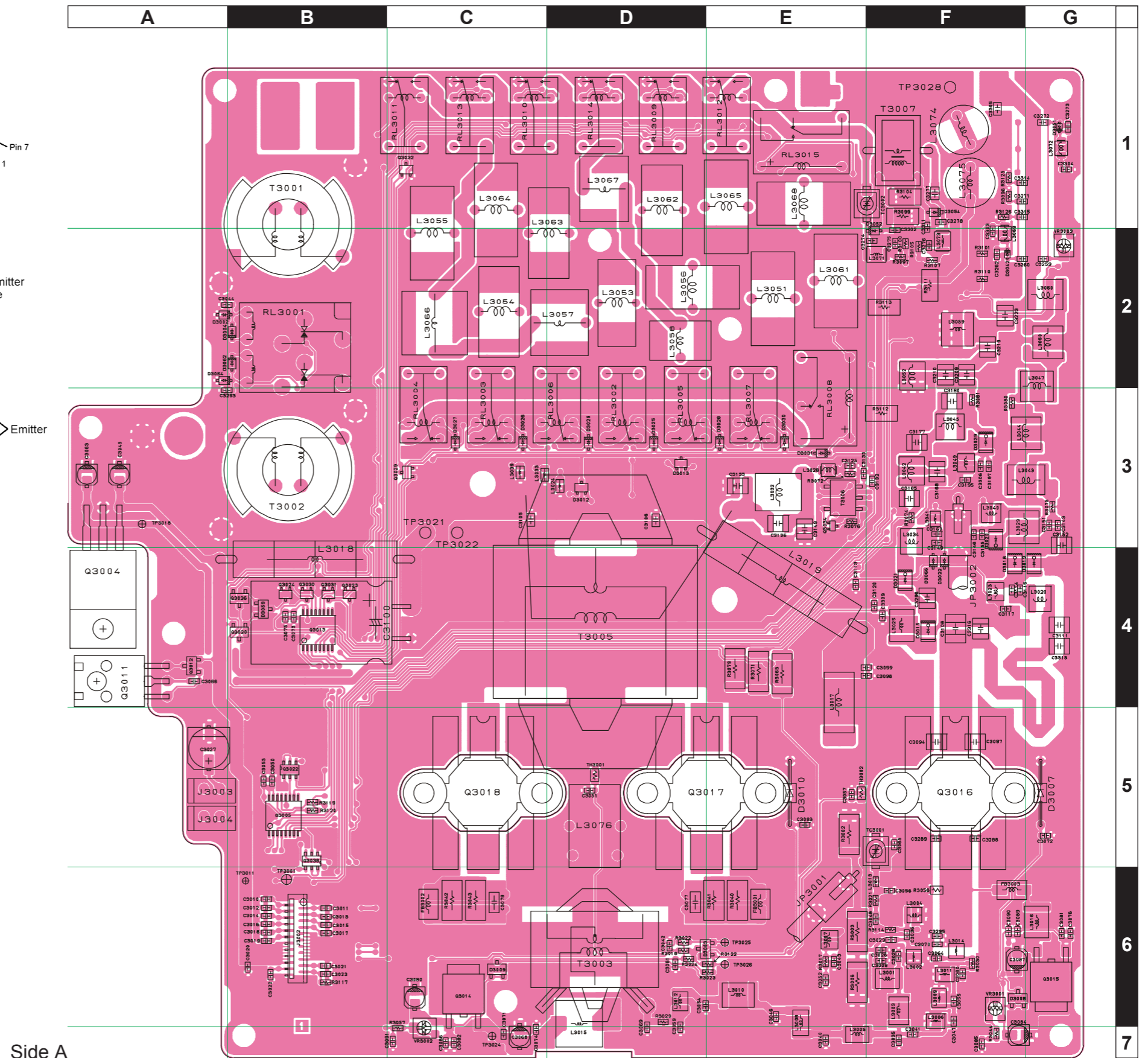
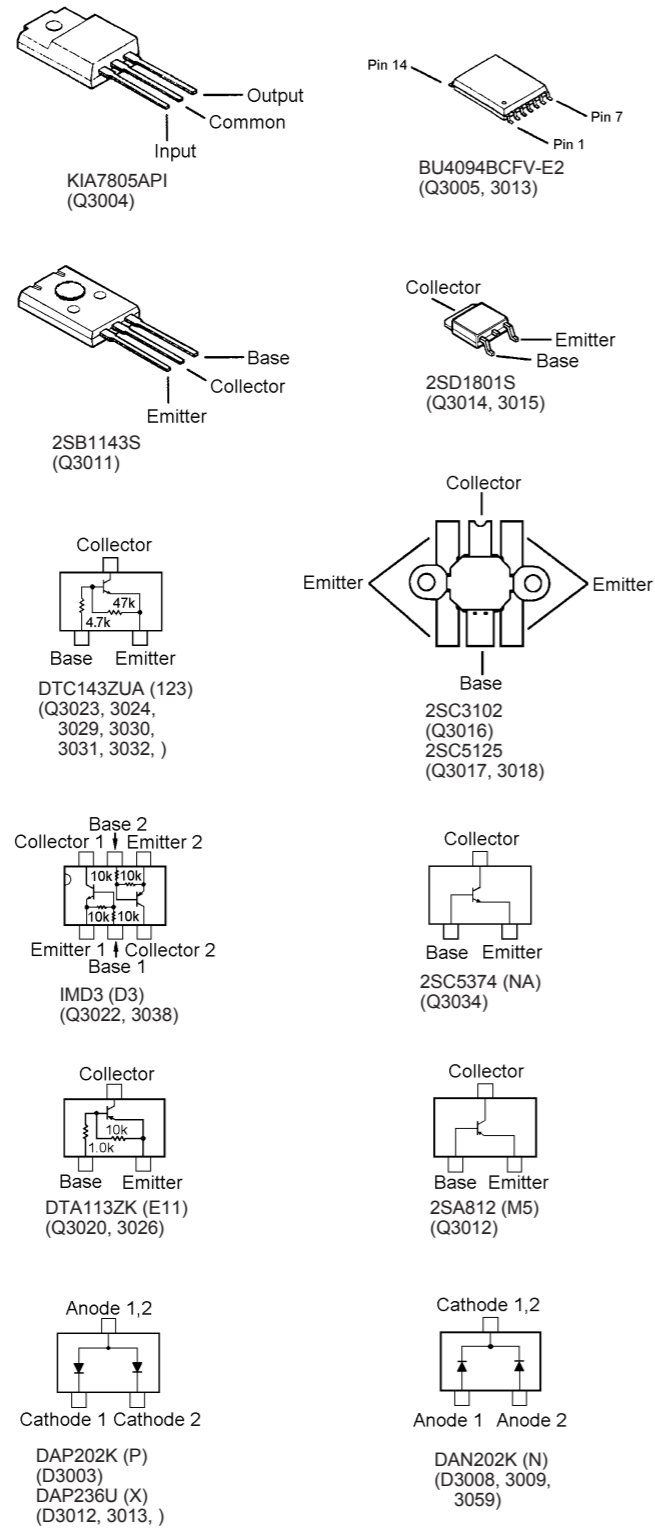

Side A

# PA Unit (Lot. 1 ~ 3)

## Parts Layout

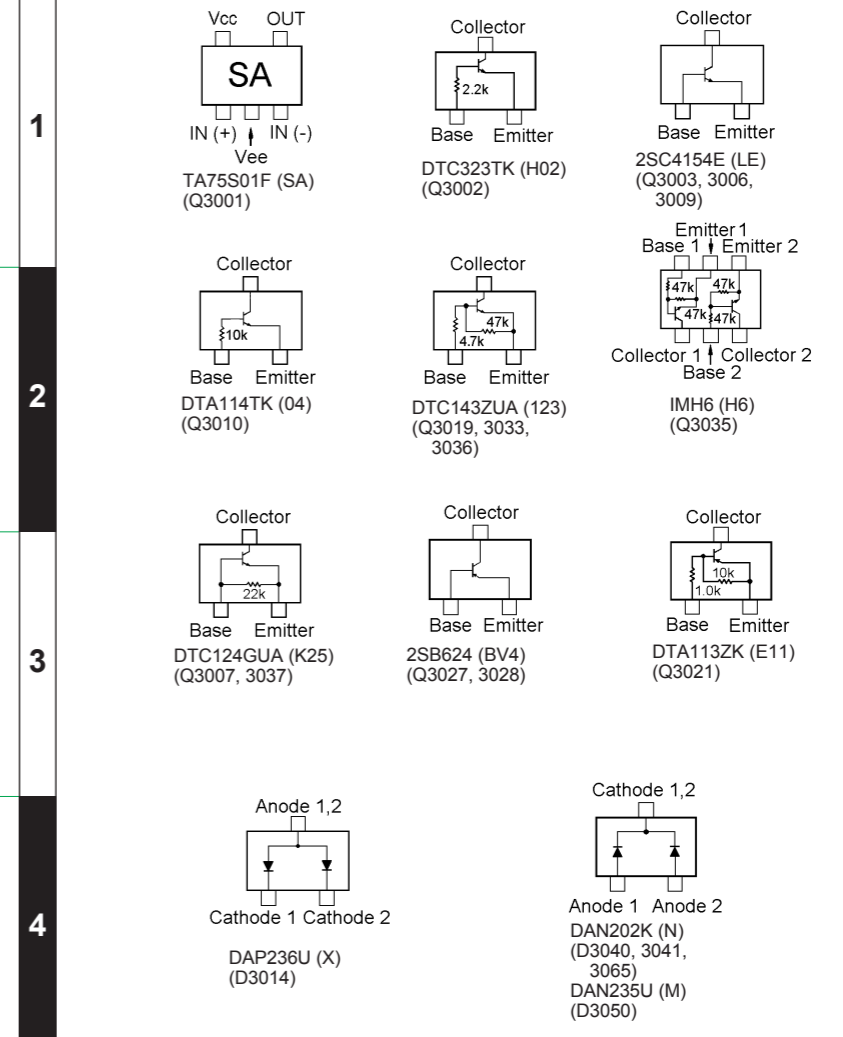
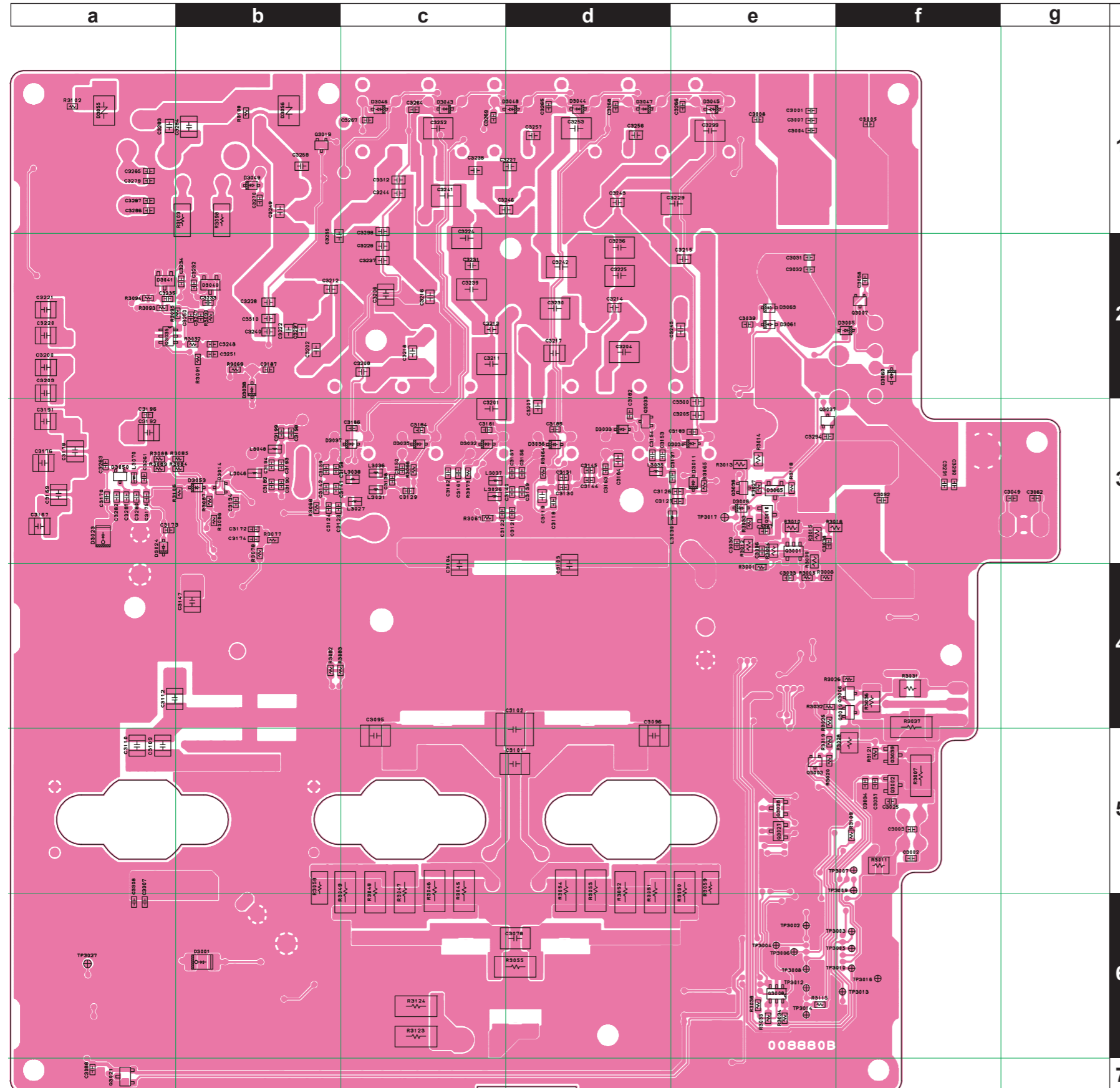

Side B

Circuit Diagram

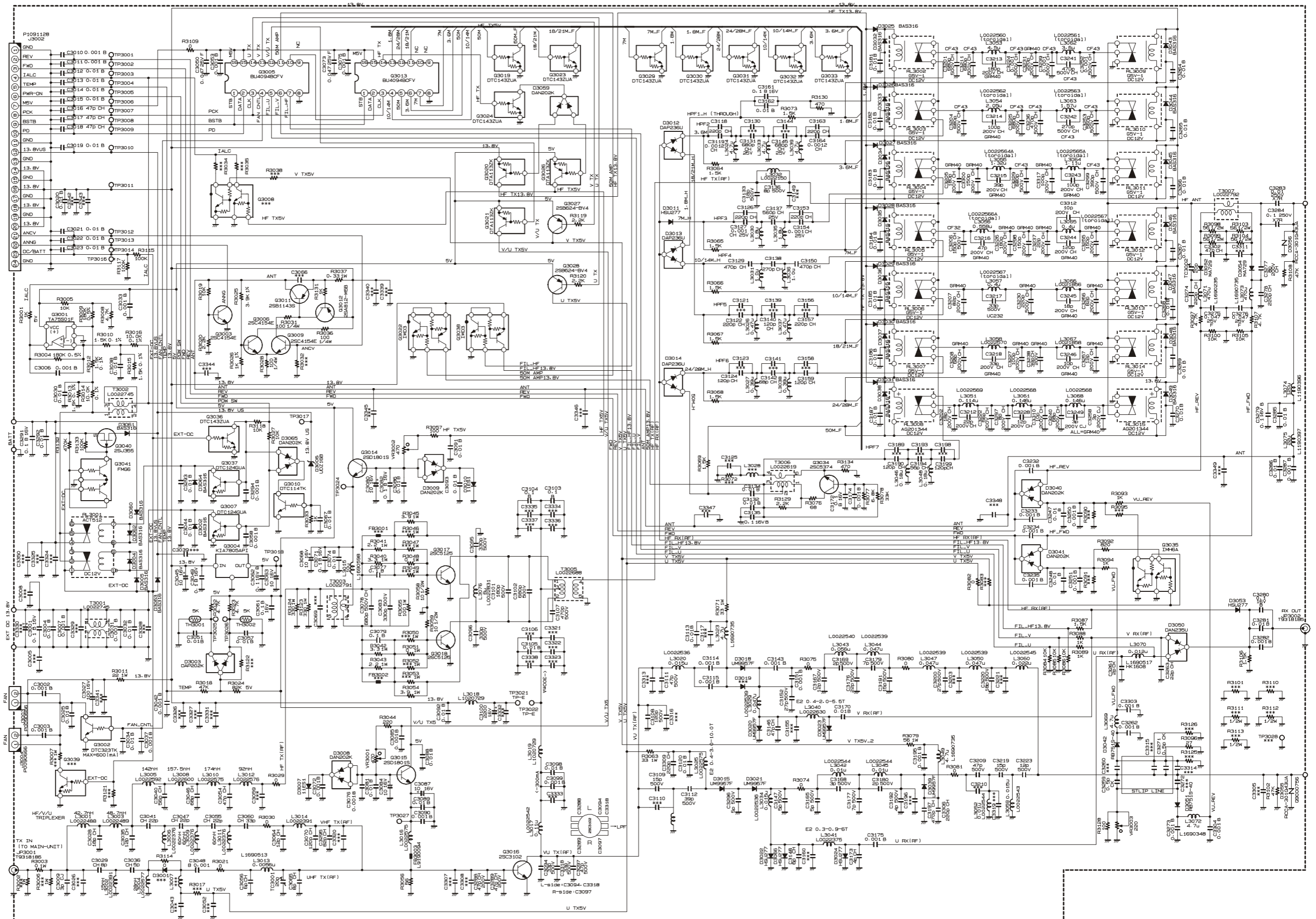

*PA Unit (Lot. 4 ~ 68)*

*Note:*

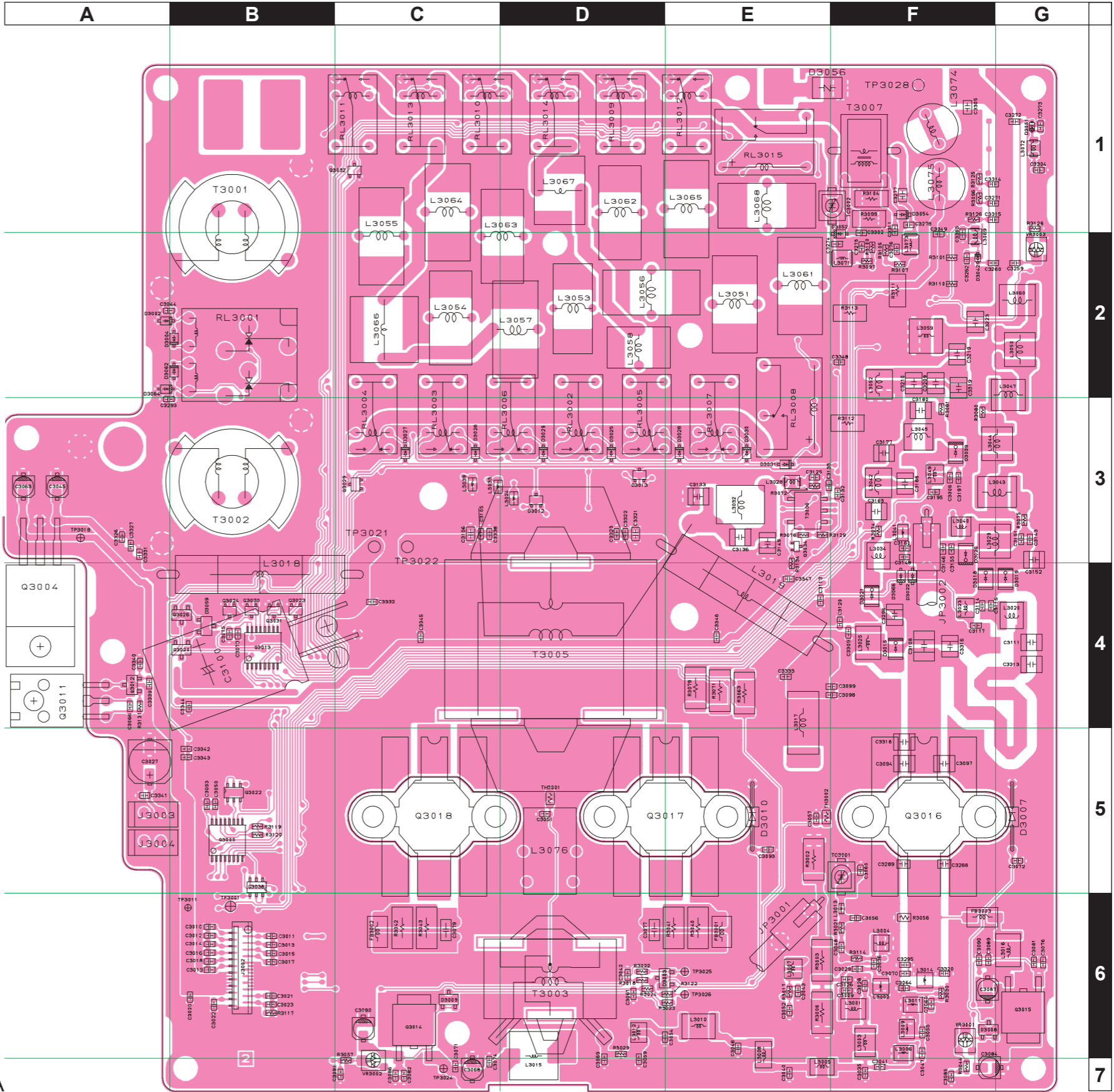
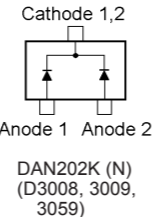
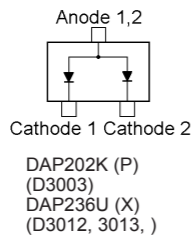
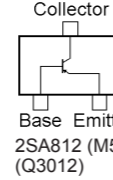
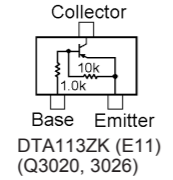
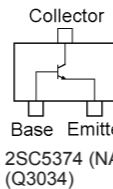
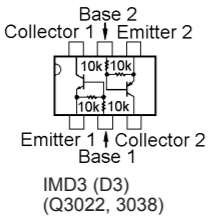
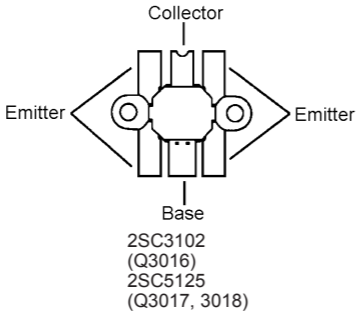
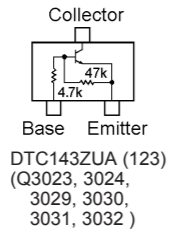
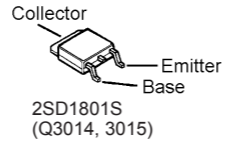
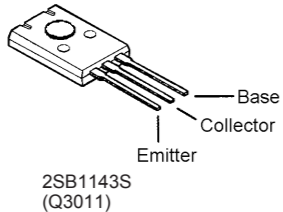
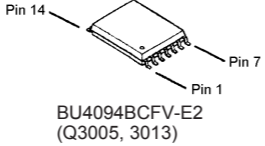
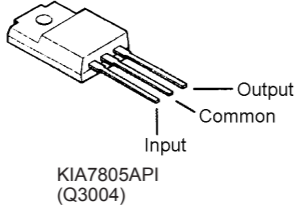

Side A

# PA Unit (Lot. 4 ~ 68)

## Parts Layout

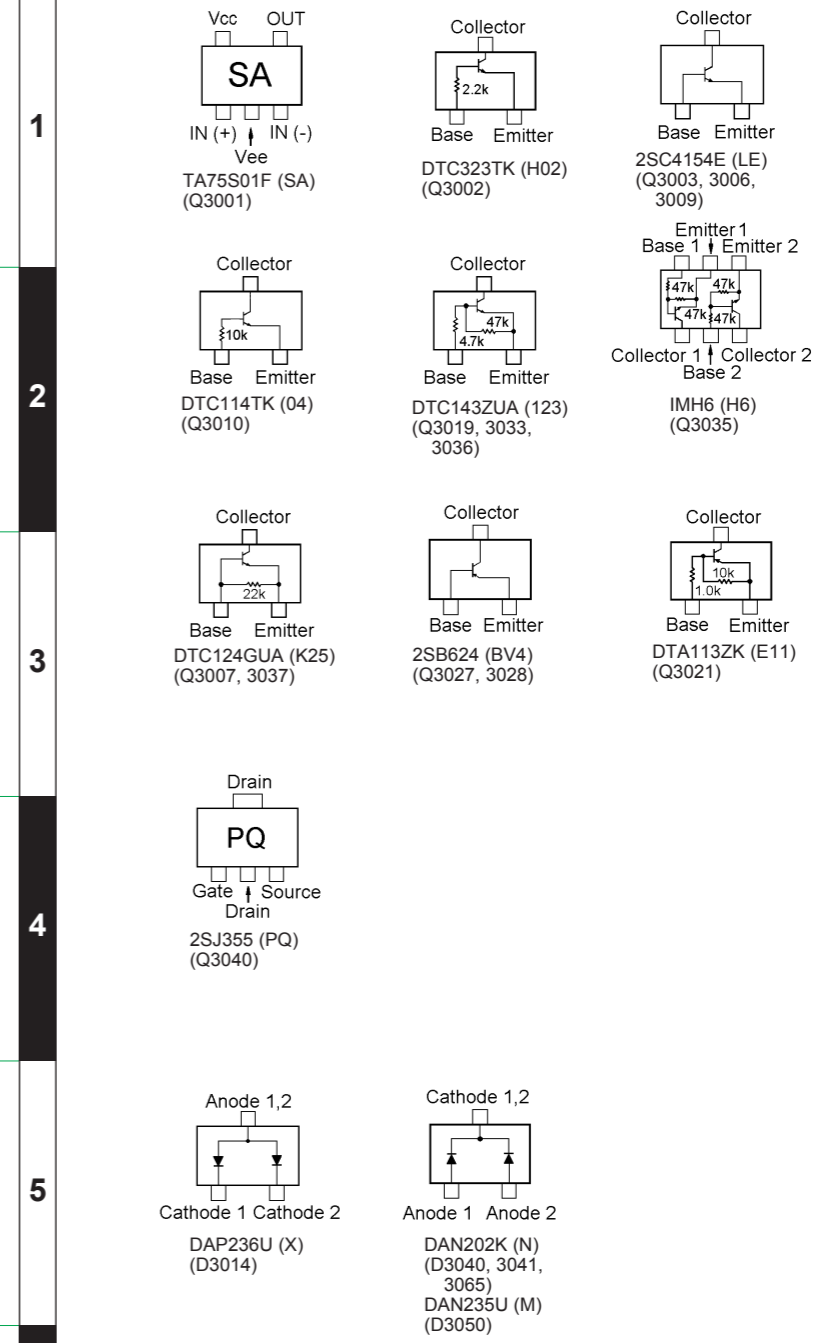
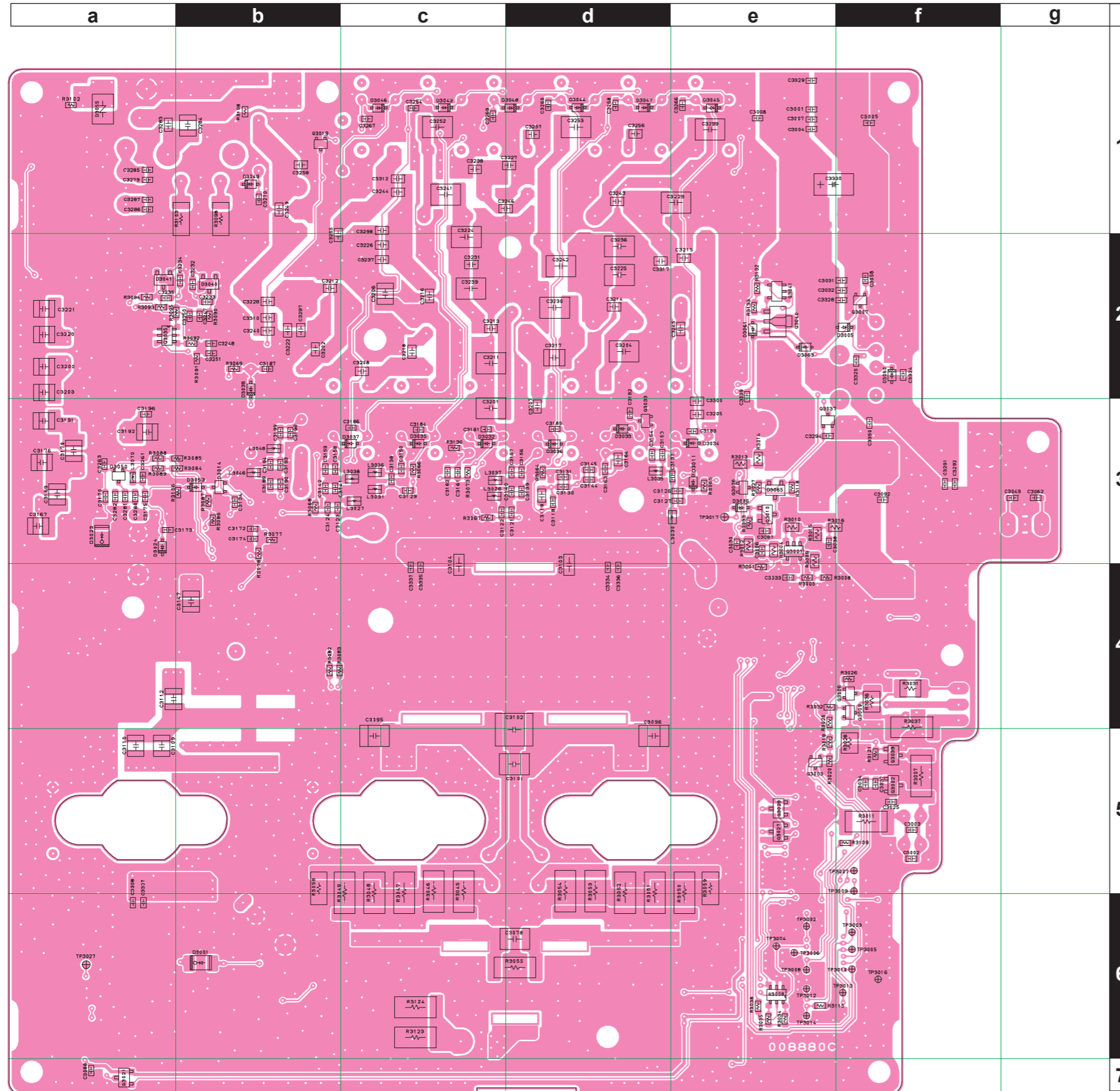

Side B



Circuit Diagram

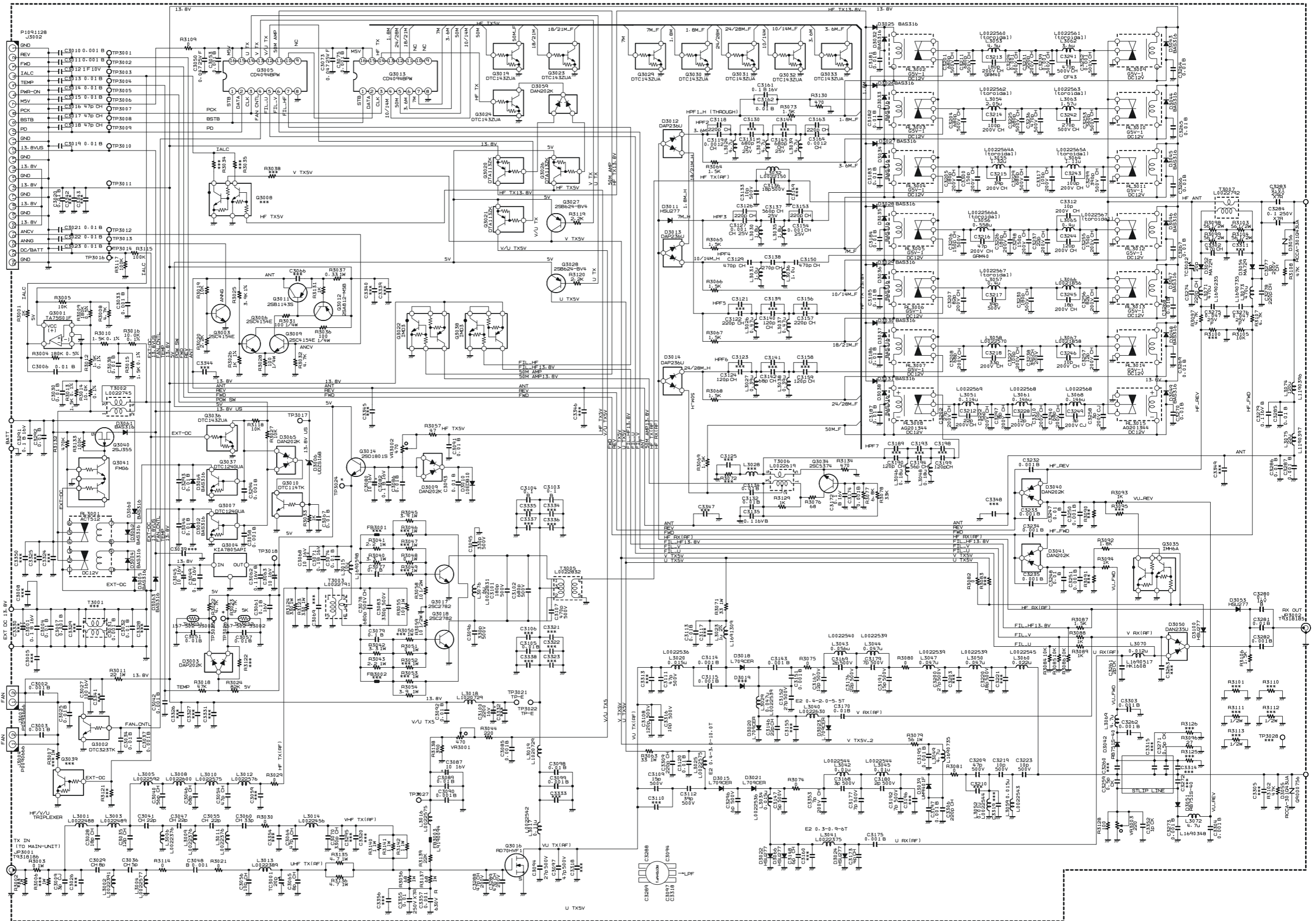

*PA Unit (Lot. 69 ~ 85)*

*Note:*

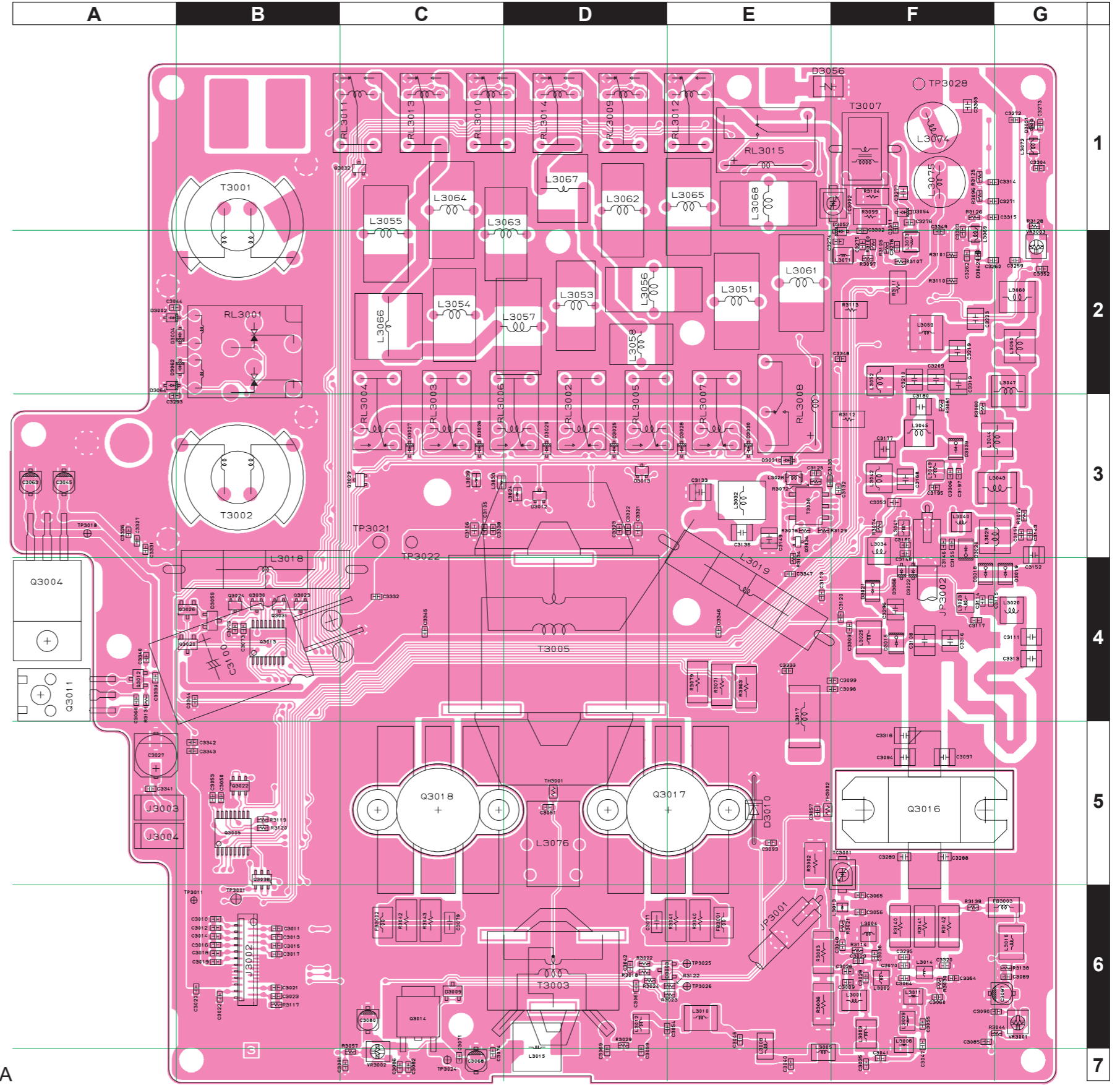
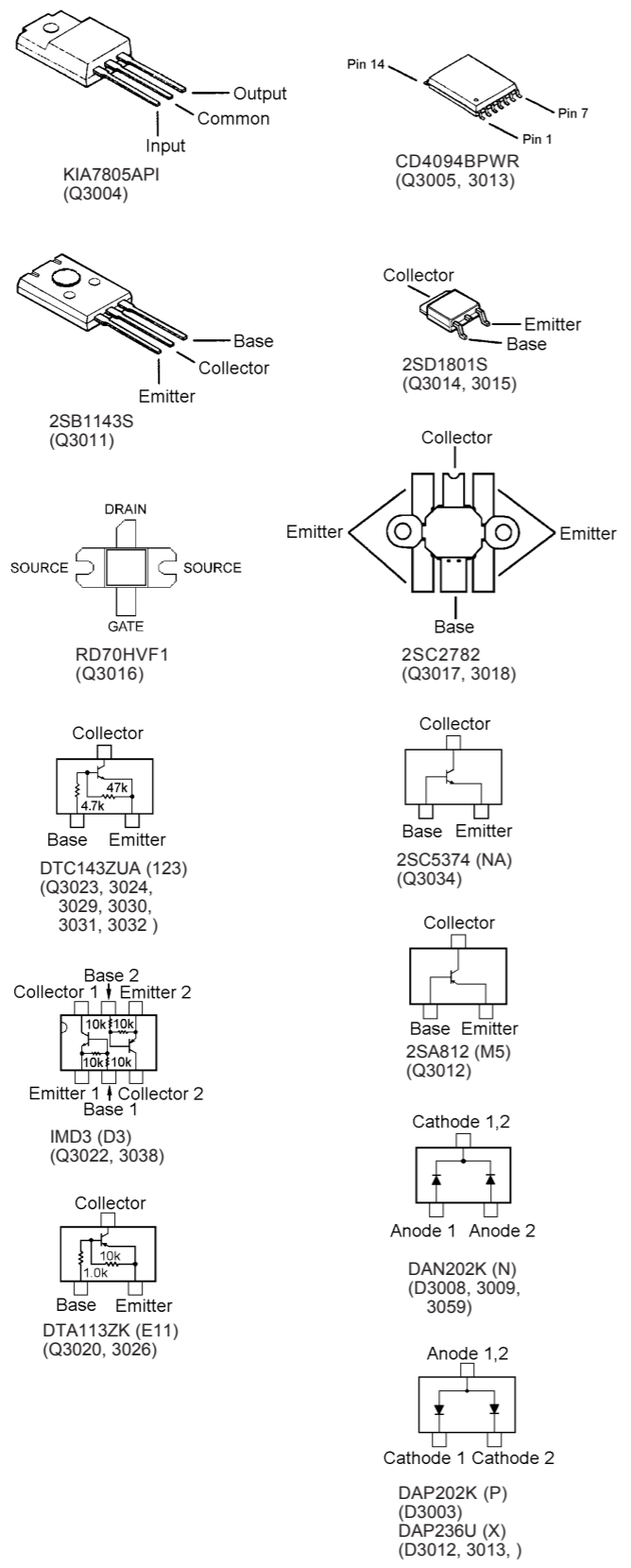

# PA Unit (Lot. 69 ~ 85)

## Parts Layout

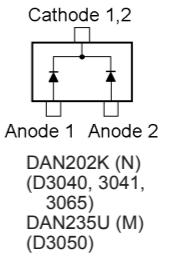
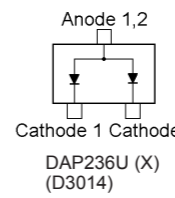
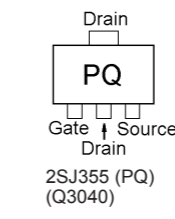
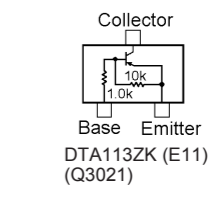
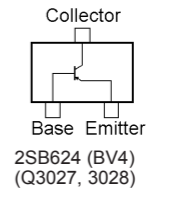
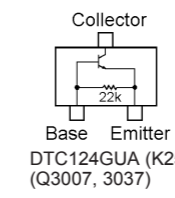
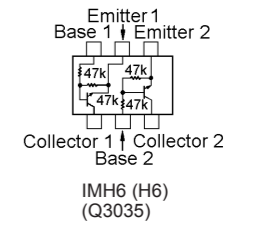
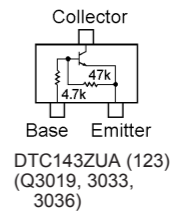
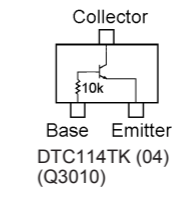
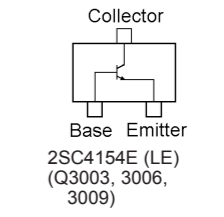
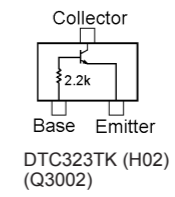
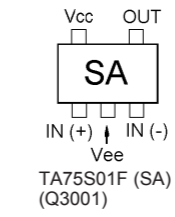
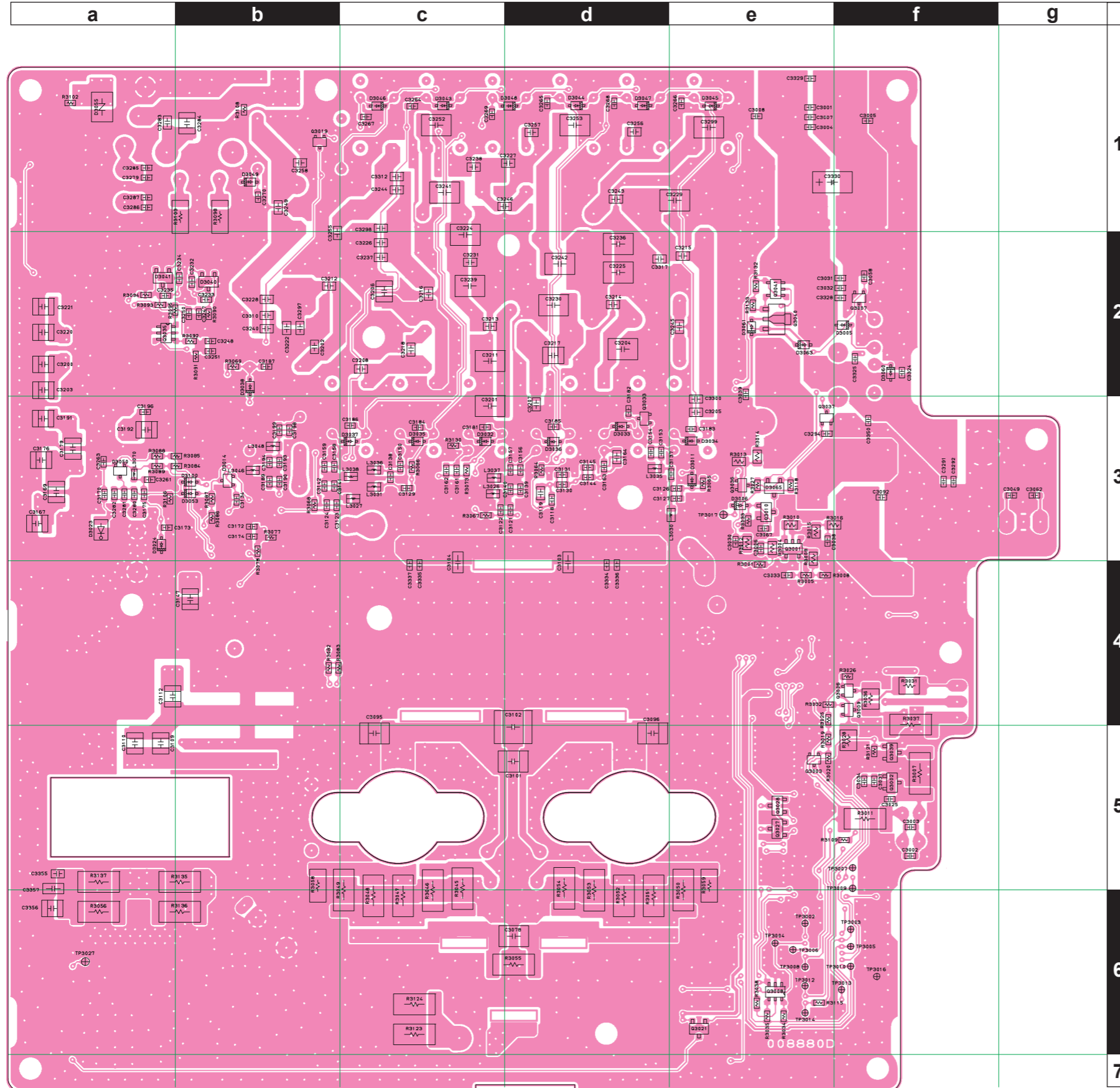

Side B

Circuit Diagram

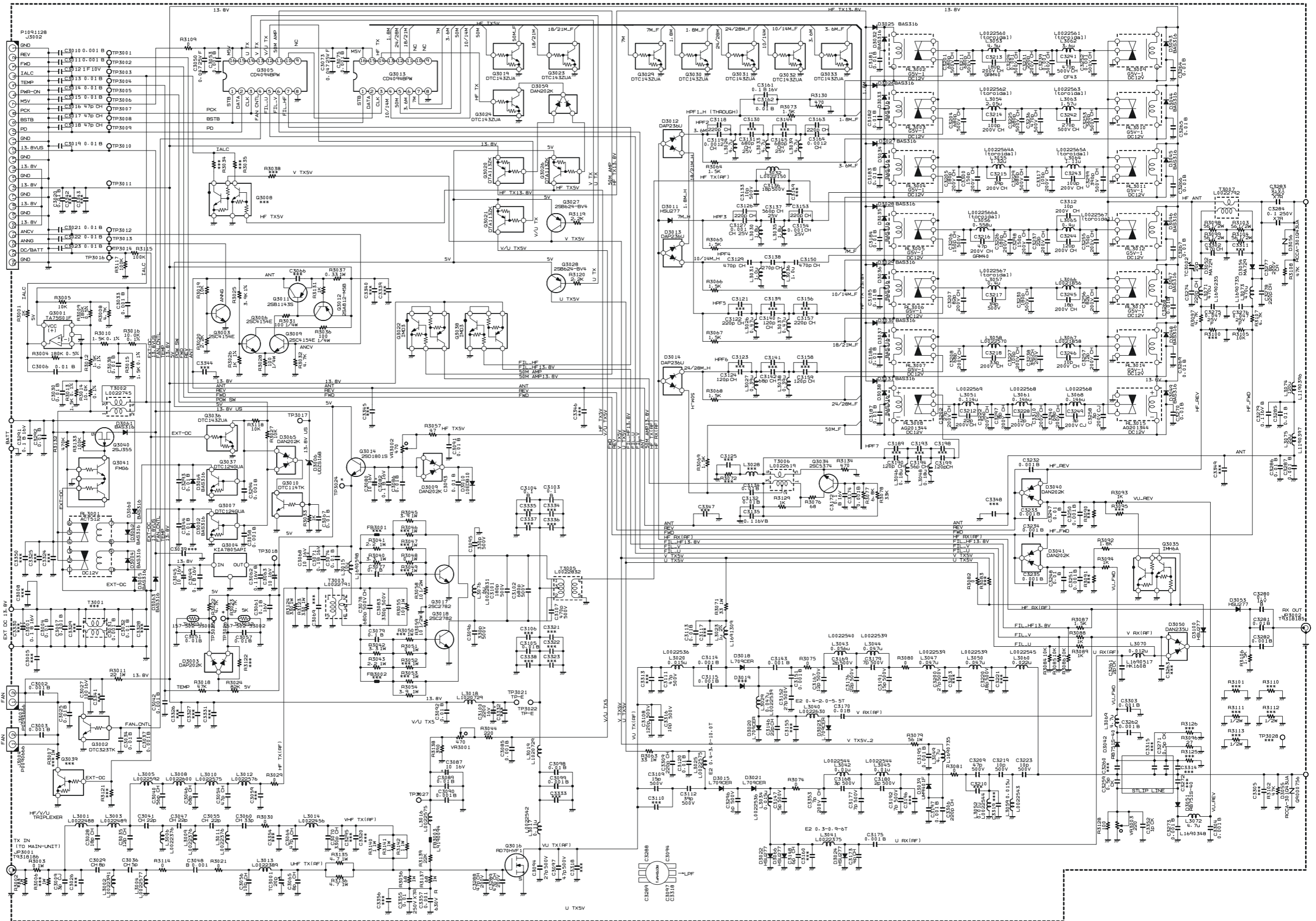

*PA Unit (Lot. 86 ~)*

*Note:*

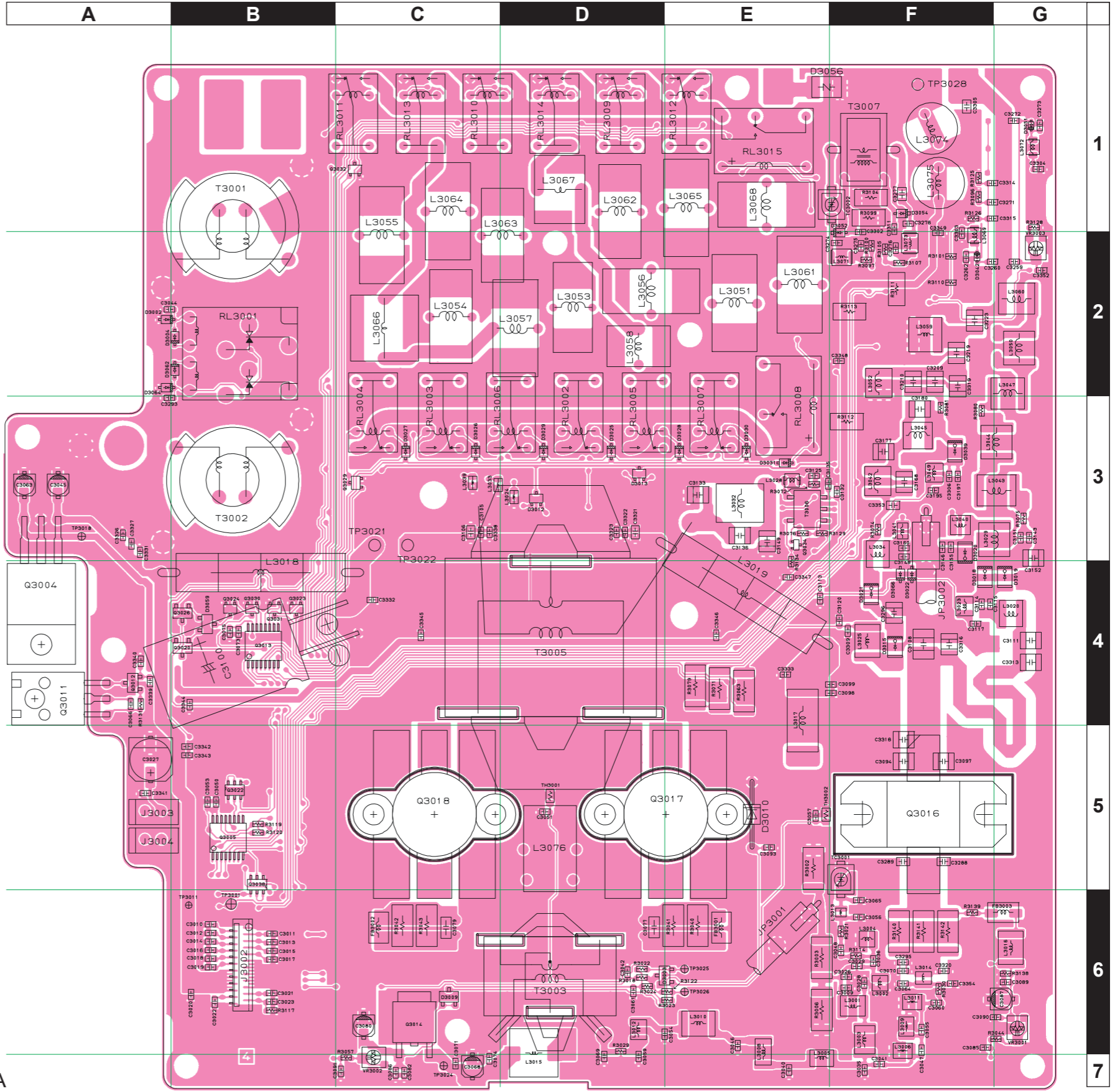
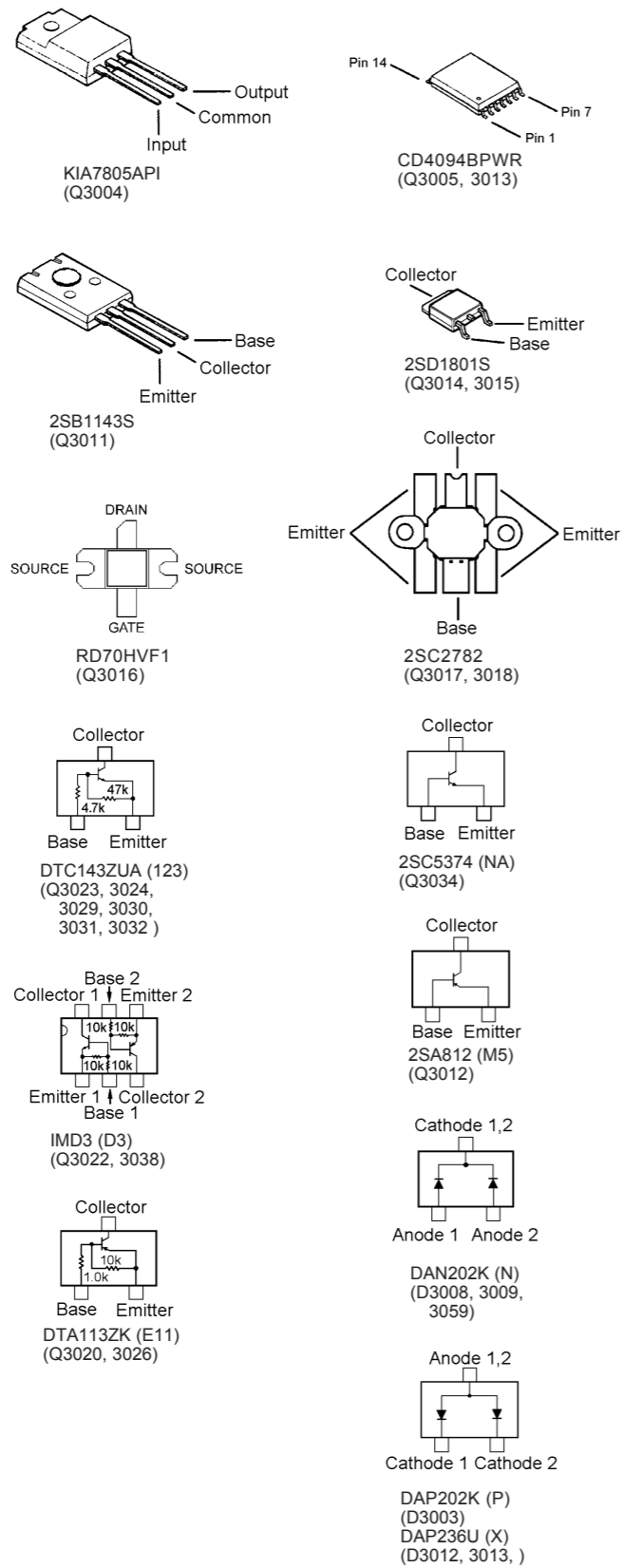

Side A

# PA Unit (Lot. 86 ~)

## Parts Layout

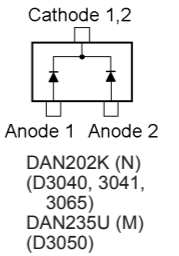
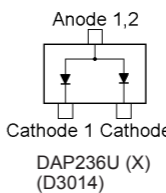
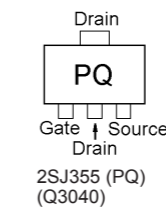
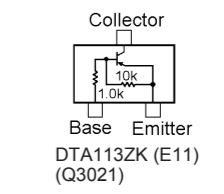
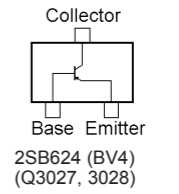
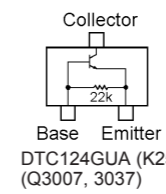
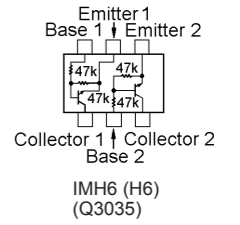
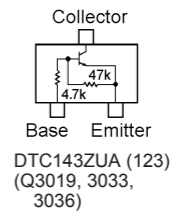
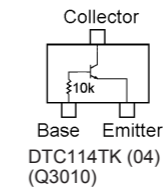
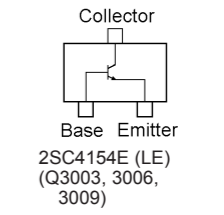
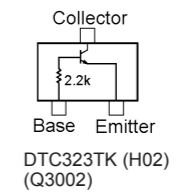
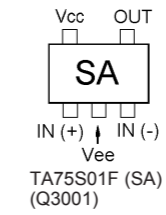
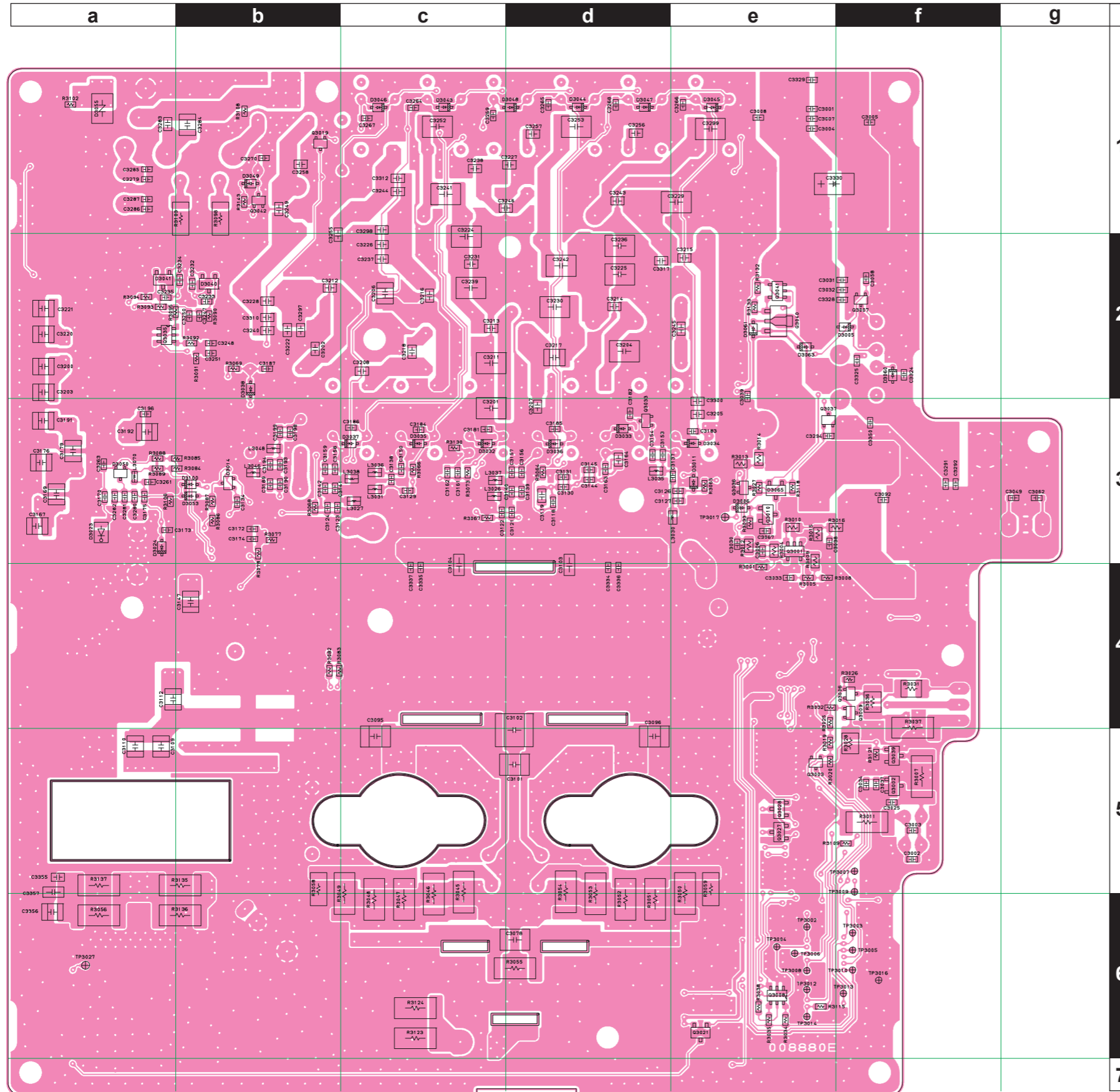

Side B



REF	DESCRIPTION	VALUE	V/W	TOL.	MFR'S DESIG	VXSTD P/N	VERS.	LOT	SIDE	LAYADR
PCB with Components						CS1852004*	USA	1-68		
						CS1852005*	EXP	1-68		
						CS1852006*	AUS	1-68		
						CS1852007*	FRA	1-68		
						CS1852008*	CE:ON EXP	1-68		
						CS1852009*	CE:ON FRA	1-68		
						CS1877004	USA	69-		
						CS1877005	EXP	69-		
						CS1877006	AUS	69-		
						CS1877007	FRA	69-		
						CS1877008	CE:ON EXP	69-		
						CS1877009	CE:ON FRA	69-		
						*: W/O Q3016/3017/3018				
Printed Circuit Board						FR008880B		1-3		
						FR008880C		4-68		
						FR008880D		69-85		
						FR008880E		86-		
C 3001	CHIP CAP.	0.1uF	16V	B	GRM188B11C104KA01D	K22124805		1-	B	e1
C 3002	CHIP CAP.	0.001uF	50V	B	GRM188B11H102KA01D	K22174821		1-	B	f5
C 3003	CHIP CAP.	0.001uF	50V	B	GRM188B11H102KA01D	K22174821		1-	B	f5
C 3004	CHIP CAP.	0.01uF	50V	B	GRM188B11H103KA01D	K22174823		1-	B	e1
C 3006	CHIP CAP.	0.001uF	50V	B	GRM188B11H102KA01D	K22174821		1-	B	e3
C 3006	CHIP CAP.	0.01uF	50V	B	GRM188B11H103KA01D	K22174823		10-	B	e3
C 3007	CHIP CAP.	0.001uF	50V	B	GRM188B11H102KA01D	K22174821		1-	B	e1
C 3009	CHIP CAP.	3pF	50V	CJ	GRM188C1H3R0CZ01D	K22174204		1-	A	F6
C 3010	CHIP CAP.	0.001uF	50V	B	GRM188B11H102KA01D	K22174821		1-	A	B6
C 3011	CHIP CAP.	0.001uF	50V	B	GRM188B11H102KA01D	K22174821		1-	A	B6
C 3012	CHIP CAP.	0.01uF	50V	B	GRM188B11H103KA01D	K22174823		1-	A	B6
C 3012	CHIP CAP.	1uF	10V	F	GRM188F11A105ZA01D	K22105001		10-	A	B6
C 3013	CHIP CAP.	0.01uF	50V	B	GRM188B11H103KA01D	K22174823		1-	A	B6
C 3014	CHIP CAP.	0.01uF	50V	B	GRM188B11H103KA01D	K22174823		1-	A	B6
C 3015	CHIP CAP.	0.01uF	50V	B	GRM188B11H103KA01D	K22174823		1-	A	B6
C 3016	CHIP CAP.	47pF	50V	CH	GRM188C1H470JA01D	K22174227		1-	A	B6
C 3017	CHIP CAP.	47pF	50V	CH	GRM188C1H470JA01D	K22174227		1-	A	B6
C 3018	CHIP CAP.	47pF	50V	CH	GRM188C1H470JA01D	K22174227		1-	A	B6
C 3019	CHIP CAP.	0.01uF	50V	B	GRM188B11H103KA01D	K22174823		1-	A	B6
C 3020	CHIP CAP.	0.01uF	50V	B	GRM188B11H103KA01D	K22174823		1-	A	B6
C 3021	CHIP CAP.	0.01uF	50V	B	GRM188B11H103KA01D	K22174823		1-	A	B6
C 3022	CHIP CAP.	0.01uF	50V	B	GRM188B11H103KA01D	K22174823		1-	A	B6
C 3023	CHIP CAP.	0.01uF	50V	B	GRM188B11H103KA01D	K22174823		1-	A	B6
C 3025	CHIP CAP.	0.01uF	50V	B	GRM188B11H103KA01D	K22174823		1-	B	f5
C 3027	AL.ELECTRO.CAP.	100uF	16V		EEE1CA101WP	K48120012		1-	A	A5
C 3028	CHIP CAP.	18pF	50V	CH	GRM188C1H180JA01D	K22174217		1-	A	F6
C 3029	CHIP CAP.	8pF	50V	CH	GRM188C1H8R0DZ01D	K22174209		1-	A	F6
C 3030	CHIP CAP.	0.01uF	50V	B	GRM188B11H103KA01D	K22174823		1-	B	e3
C 3031	CHIP CAP.	0.001uF	50V	B	GRM188B11H102KA01D	K22174821		1-	B	f2
C 3032	CHIP CAP.	0.01uF	50V	B	GRM188B11H103KA01D	K22174823		1-	B	f2
C 3033	CHIP CAP.	0.001uF	50V	B	GRM188B11H102KA01D	K22174821		1-	B	e4
C 3034	CHIP CAP.	0.01uF	50V	B	GRM188B11H103KA01D	K22174823		1-	B	f5
C 3035	CHIP CAP.	12pF	50V	CH	GRM188C1H120JA01D	K22174213		1-	A	F7
C 3036	CHIP CAP.	5pF	50V	CH	GRM188C1H5R0CZ01D	K22174206		1-	A	F6
C 3037	CHIP CAP.	0.001uF	50V	B	GRM188B11H102KA01D	K22174821		1-	B	f5
C 3038	CHIP CAP.	0.01uF	50V	B	GRM188B11H103KA01D	K22174823		1-	B	e3
C 3040	CHIP CAP.	56pF	50V	CH	GRM188C1H560JA01D	K22174229		1-	A	E7
C 3041	CHIP CAP.	22pF	50V	CH	GRM188C1H220JA01D	K22174219		1-	A	F7
C 3042	CHIP CAP.	0.001uF	50V	B	GRM188B11H102KA01D	K22174821		1-	A	D6
C 3044	CHIP CAP.	0.01uF	50V	B	GRM188B11H103KA01D	K22174823		1-	A	A2
C 3045	AL.ELECTRO.CAP.	10uF	16V		RV2-16V100MB55U-R	K48120014		1-	A	A3
C 3046	CHIP CAP.	68pF	50V	CH	GRM188C1H680JA01D	K22174231		1-	A	E6
C 3047	CHIP CAP.	22pF	50V	CH	GRM188C1H220JA01D	K22174219		1-	A	F6
C 3048	CHIP CAP.	0.001uF	50V	B	GRM188B11H102KA01D	K22174821		1-	A	F6
C 3049	CHIP CAP.	0.1uF	16V	B	GRM188B11C104KA01D	K22124805		1-	B	g3
C 3050	CHIP CAP.	0.047uF	25V	F	GRM39F473Z25PT	K22145002		1-	A	B5
C 3050	CHIP CAP.	0.047uF	50V	F	GRM188F11H473ZA01D	K22175001		90-	A	B5
C 3051	CHIP CAP.	0.01uF	50V	B	GRM188B11H103KA01D	K22174823		1-	A	D5
C 3053	CHIP CAP.	0.001uF	50V	B	GRM188B11H102KA01D	K22174821		1-	A	B5
C 3054	CHIP CAP.	47pF	50V	CH	GRM188C1H470JA01D	K22174227		1-	A	D6
C 3055	CHIP CAP.	22pF	50V	CH	GRM188C1H220JA01D	K22174219		1-	A	F6
C 3056	CHIP CAP.	6pF	50V	CH	GRM188C1H6R0DZ01D	K22174207		1-	A	F6
C 3056	CHIP CAP.	10pF	50V	CH	GRM188C1H100JA01D	K22174211		69-	A	F6
C 3057	CHIP CAP.	0.01uF	50V	B	GRM188B11H103KA01D	K22174823		1-	A	E5
C 3058	CHIP CAP.	0.001uF	50V	B	GRM188B11H102KA01D	K22174821		1-	B	f2
C 3060	CHIP CAP.	33pF	50V	CH	GRM188C1H330JA01D	K22174223		1-	A	F6

# PA Unit

## Parts List

REF	DESCRIPTION	VALUE	V/W	TOL.	MFR'S DESIG	VXSTD P/N	VERS.	LOT	SIDE	LAYADR
C 3061	CHIP CAP.	0.1uF	16V	B	GRM188B11C104KA01D	K22124805		1-	A	D6
C 3062	CHIP CAP.	0.1uF	16V	B	GRM188B11C104KA01D	K22124805		1-	B	g3
C 3063	AL.ELECTRO.CAP.	10uF	16V		RV2-16V100MB55U-R	K48120014		1-	A	A3
C 3064	CHIP CAP.	12pF	50V	CH	GRM1882C1H120JA01D	K22174213		1-	A	F6
C 3064	CHIP CAP.	47pF	50V	CH	GRM1882C1H470JA01D	K22174227		69-	A	F6
C 3065	CHIP CAP.	8pF	50V	CH	GRM1882C1H8R0DZ01D	K22174209		1-	A	F6
C 3067	CHIP CAP.	0.01uF	50V	B	GRM188B11H103KA01D	K22174823		1-	B	e3
C 3068	AL.ELECTRO.CAP.	10uF	16V		RV2-16V100MB55U-R	K48120014		1-	A	C7
C 3070	CHIP CAP.	180pF	50V	CH	GRM1882C1H181JA01D	K22174241		1-	A	F6
C 3070	CHIP CAP.	330pF	50V	CH	GRM1882C1H331JA01D	K22174253		69-	A	F6
C 3071	CHIP CAP.	0.1uF	16V	B	GRM188B11C104KA01D	K22124805		1-	A	C7
C 3072	CHIP CAP.	0.001uF	50V	B	GRM188B11H102KA01D	K22174821		1-68		
C 3073	CHIP CAP.	0.047uF	25V	F	GRM39F473Z25PT	K22145002		1-	A	B4
C 3073	CHIP CAP.	0.047uF	50V	F	GRM188F11H473ZA01D	K22175001		90-	A	B4
C 3074	CHIP CAP.	0.01uF	50V	B	GRM188B11H103KA01D	K22174823		1-	A	C7
C 3075	CHIP CAP.	0.001uF	50V	B	GRM188B11H102KA01D	K22174821		1-	A	B4
C 3076	CHIP CAP.	0.001uF	50V	B	GRM188B11H102KA01D	K22174821		1-68		
C 3077	CHIP CAP.	0.1uF	50V	B	GRM42-6B104K50PT	K22171820		1-	A	D6
C 3078	CHIP CAP.	680pF	500V	CH	CF43CH681J500AT	K22277218		1-	B	d6
C 3079	CHIP CAP.	0.1uF	50V	B	GRM42-6B104K50PT	K22171820		1-	A	C6
C 3080	AL.ELECTRO.CAP.	10uF	16V		RV2-16V100MB55U-R	K48120014		1-	A	C6
C 3081	CHIP CAP.	0.01uF	50V	B	GRM188B11H103KA01D	K22174823		1-68		
C 3082	CHIP CAP.	0.1uF	16V	B	GRM188B11C104KA01D	K22124805		1-	A	C7
C 3083	FILM CAP.	330pF	500V		UC342H3300J-T	K33279014		1-		
C 3084	AL.ELECTRO.CAP.	10uF	16V		RV2-16V100MB55U-R	K48120014		1-68		
C 3085	CHIP CAP.	0.001uF	50V	B	GRM188B11H102KA01D	K22174821		1-	A	F6
C 3086	CHIP CAP.	0.01uF	50V	B	GRM188B11H103KA01D	K22174823		1-	A	C7
C 3087	AL.ELECTRO.CAP.	10uF	16V		RV2-16V100MB55U-R	K48120014		1-	A	G6
C 3088	CHIP CAP.	0.01uF	50V	B	GRM188B11H103KA01D	K22174823		1-68		
C 3089	CHIP CAP.	0.01uF	50V	B	GRM188B11H103KA01D	K22174823		1-	A	G6
C 3090	CHIP CAP.	0.001uF	50V	B	GRM188B11H102KA01D	K22174821		1-	A	F6
C 3091	CHIP CAP.	0.01uF	50V	B	GRM188B11H103KA01D	K22174823		1-	A	C7
C 3092	CHIP CAP.	0.01uF	50V	B	GRM188B11H103KA01D	K22174823		1-	B	f3
C 3093	CHIP CAP.	0.01uF	50V	B	GRM188B11H103KA01D	K22174823		1-	A	E5
C 3094	FILM CAP.	33pF	500V		UC232H0330J-T	K33279024		1	A	F5
C 3094	FILM CAP.	56pF	500V		UC232H0560J-T	K33279035		2-	A	F5
C 3094	FILM CAP.	27pF	500V		UC232H0270J-T	K33279023		69-	A	F5
C 3095	FILM CAP.	330pF	500V		UC342H3300J-T	K33279014		1-	B	c5
C 3096	FILM CAP.	330pF	500V		UC342H3300J-T	K33279014		1-	B	d5
C 3097	FILM CAP.	47pF	500V		UC232H0470J-T	K33279034		1-	A	F5
C 3098	CHIP CAP.	0.01uF	50V	B	GRM188B11H103KA01D	K22174823		1-	A	F4
C 3099	CHIP CAP.	0.001uF	50V	B	GRM188B11H102KA01D	K22174821		1-	A	F4
C 3100	AL.ELECTRO.CAP.	2200uF	16V		RE3-16V222M15#	K40129064		1-	A	C4
C 3101	FILM CAP.	180pF	500V		UC342H1800J-T	K33279039		1-	B	d5
C 3102	FILM CAP.	680pF	500V		UC552H6800J-T	K33279042		1-	B	d4
C 3103	CHIP CAP.	0.1uF	250V	X7R	GRM32DR72E104KW01L	K22245801		1-	B	d3
C 3103	CHIP CAP.	0.1uF	50V	B	GRM42-6B104K50PT	K22171820		4-	B	d3
C 3104	CHIP CAP.	0.1uF	250V	X7R	GRM32DR72E104KW01L	K22245801		1-	B	c3
C 3104	CHIP CAP.	0.1uF	50V	B	GRM42-6B104K50PT	K22171820		4-	B	c3
C 3105	CHIP CAP.	0.01uF	250V	X7R	GRM21BR72E103KW03L	K22240801		1-	A	C3
C 3105	CHIP CAP.	0.01uF	50V	B	GRM188B11H103KA01D	K22174823		4-	A	C3
C 3106	CHIP CAP.	0.1uF	25V	B	GRM21BB11E104KA01L	K22140811	W/ CE LABEL	4-	A	C3
C 3107	FILM CAP.	470pF	500V		UC342H4700J-T	K33279015		1-		
C 3108	FILM CAP.	120pF	500V		UC342H1200J-T	K33279026		1-	A	F4
C 3109	FILM CAP.	15pF	500V		UC232H0150J-T	K33279028		1-	B	a5
C 3111	FILM CAP.	47pF	500V		UC232H0470J-T	K33279034		1-	A	G4
C 3112	FILM CAP.	39pF	500V		UC232H0390J-T	K33279038		1-	B	a4
C 3113	CHIP CAP.	0.01uF	50V	B	GRM188B11H103KA01D	K22174823		1-	A	E4
C 3114	CHIP CAP.	0.001uF	50V	B	GRM188B11H102KA01D	K22174821		1-	A	F4
C 3115	CHIP CAP.	0.001uF	50V	B	GRM188B11H102KA01D	K22174821		1-	A	F4
C 3118	CHIP CAP.	220pF	50V	CH	GRM1882C1H221JA01D	K22174243		1-	B	d3
C 3119	CHIP CAP.	0.0012uF	50V	CH	GRM40CH122J50PT	K22170290		1-	B	d3
C 3120	CHIP CAP.	0.01uF	50V	B	GRM188B11H103KA01D	K22174823		1-	A	F4
C 3122	CHIP CAP.	220pF	50V	CH	GRM1882C1H221JA01D	K22174243		1-	B	c3
C 3124	CHIP CAP.	120pF	50V	CH	GRM1882C1H121JA01D	K22174237		1-	B	b3
C 3126	CHIP CAP.	220pF	50V	CH	GRM1882C1H221JA01D	K22174243		1-	B	e3
C 3127	CHIP CAP.	0.001uF	25V	CH	GRM1882C1E102JA01D	K22144204		1-	B	e3
C 3129	CHIP CAP.	470pF	50V	CH	GRM1882C1H471JA01D	K22174249		1-	B	c3
C 3131	CHIP CAP.	680pF	25V	CH	GRM39CH681J25PT	K22144203		1-	B	d3
C 3131	CHIP CAP.	680pF	50V	CH	GRM1882C1H681JA01D	K22174274		90-	B	d3
C 3132	CHIP CAP.	0.01uF	50V	B	GRM188B11H103KA01D	K22174823		1-	A	F3
C 3133	FILM CAP.	18pF	500V		UC232H0180J-T	K33279029		1-	A	E3
C 3133	FILM CAP.	18pF	500V		UC232H0180J-T	K33279029		16-60	A	E3

# PA Unit

## Parts List

REF	DESCRIPTION	VALUE	V/W	TOL.	MFR'S DESIG	VXSTD P/N	VERS.	LOT	SIDE	LAYADR
C 3133	FILM CAP.	10pF	500V		UC232H0100D-T	K33279019		65-	A	E3
C 3134	CHIP CAP.	0.01uF	50V	B	GRM188B11H103KA01D	K22174823		1-	B	b3
C 3135	CHIP CAP.	0.1uF	16V	B	GRM188B11C104KA01D	K22124805		1-	A	E3
C 3136	FILM CAP.	8pF	500V		UC232H0080D-T	K33279005		1-	A	E3
C 3136	FILM CAP.	18pF	500V		UC232H0180J-T	K33279029		16-	A	E3
C 3137	CHIP CAP.	560pF	25V	CH	GRM39CH561J25PT	K22144201		1-	B	e3
C 3137	CHIP CAP.	560pF	50V	CH	GRM1882C1H561JA01D	K22174273		90-	B	e3
C 3138	CHIP CAP.	270pF	50V	CH	GRM1882C1H271JA01D	K22174251		1-	B	c3
C 3140	CHIP CAP.	120pF	50V	CH	GRM1882C1H121JA01D	K22174237		1-	B	d3
C 3142	CHIP CAP.	68pF	50V	CH	GRM1882C1H680JA01D	K22174231		1-	B	b3
C 3143	CHIP CAP.	0.001uF	50V	B	GRM188B11H102KA01D	K22174821		1-	A	G3
C 3145	CHIP CAP.	680pF	25V	CH	GRM39CH681J25PT	K22144203		1-	B	d3
C 3145	CHIP CAP.	680pF	50V	CH	GRM1882C1H681JA01D	K22174274		90-	B	d3
C 3146	CHIP CAP.	47pF	50V	CH	GRM1882C1H470JA01D	K22174227		1-	A	F3
C 3146	CHIP CAP.	22pF	50V	CH	GRM1882C1H220JA01D	K22174219		10-	A	F3
C 3147	FILM CAP.	5pF	500V		UC232H0050D-T	K33279010		1-	B	b4
C 3148	CHIP CAP.	6pF	50V	CH	GRM1882C1H6R0DZ01D	K22174207		1-	A	F3
C 3150	CHIP CAP.	470pF	50V	CH	GRM1882C1H471JA01D	K22174249		1-	B	c3
C 3151	CHIP CAP.	0.001uF	50V	B	GRM188B11H102KA01D	K22174821		1-	A	G3
C 3152	FILM CAP.	27pF	500V		UC232H0270J-T	K33279023		1-	A	G3
C 3153	CHIP CAP.	220pF	50V	CH	GRM1882C1H221JA01D	K22174243		1-	B	d3
C 3154	CHIP CAP.	0.001uF	25V	CH	GRM1882C1E102JA01D	K22144204		1-	B	d3
C 3157	CHIP CAP.	220pF	50V	CH	GRM1882C1H221JA01D	K22174243		1-	B	d3
C 3159	CHIP CAP.	120pF	50V	CH	GRM1882C1H121JA01D	K22174237		1-	B	b3
C 3161	CHIP CAP.	0.1uF	16V	B	GRM188B11C104KA01D	K22124805		1-	B	c3
C 3162	CHIP CAP.	0.01uF	50V	B	GRM188B11H103KA01D	K22174823		1-	B	c3
C 3163	CHIP CAP.	220pF	50V	CH	GRM1882C1H221JA01D	K22174243		1-	B	d3
C 3164	CHIP CAP.	0.0012uF	50V	CH	GRM40CH122J50PT	K22170290		1-	B	d3
C 3165	FILM CAP.	5pF	500V		UC232H0050D-T	K33279010		1-4		
C 3167	FILM CAP.	12pF	500V		UC232H0120J-T	K33279020		1-	B	a3
C 3168	FILM CAP.	3pF	500V		UC232H0030D-T	K33279027		1-	A	F3
C 3169	FILM CAP.	2pF	500V		UC232H0020D-T	K33279043		1-	B	a3
C 3170	CHIP CAP.	0.01uF	50V	B	GRM188B11H103KA01D	K22174823		1-	B	a3
C 3172	CHIP CAP.	0.1uF	16V	B	GRM188B11C104KA01D	K22124805		1-	B	b3
C 3173	CHIP CAP.	4pF	50V	CH	GRM1882C1H4R0CZ01D	K22174205		1-	B	a3
C 3173	CHIP CAP.	2pF	50V	CK	GRM1884C1H2R0CZ01D	K22174203		104-	B	a3
C 3174	CHIP CAP.	0.001uF	50V	B	GRM188B11H102KA01D	K22174821		1-	B	b3
C 3175	CHIP CAP.	0.001uF	50V	B	GRM188B11H102KA01D	K22174821		1-	B	a3
C 3176	FILM CAP.	22pF	500V		UC232H0220J-T	K33279021		1-	B	a3
C 3177	FILM CAP.	7pF	500V		UC232H0070D-T	K33279046		1-	A	F3
C 3179	FILM CAP.	7pF	500V		UC232H0070D-T	K33279046		1-	B	a3
C 3180	FILM CAP.	2pF	500V		UC232H0020D-T	K33279043		1-	A	F3
C 3181	CHIP CAP.	0.01uF	50V	B	GRM188B11H103KA01D	K22174823		1-	B	c3
C 3182	CHIP CAP.	0.01uF	50V	B	GRM188B11H103KA01D	K22174823		1-	B	d3
C 3183	CHIP CAP.	0.01uF	50V	B	GRM188B11H103KA01D	K22174823		1-	B	e3
C 3184	CHIP CAP.	0.01uF	50V	B	GRM188B11H103KA01D	K22174823		1-	B	c3
C 3185	CHIP CAP.	0.01uF	50V	B	GRM188B11H103KA01D	K22174823		1-	B	d3
C 3186	CHIP CAP.	0.01uF	50V	B	GRM188B11H103KA01D	K22174823		1-	B	c3
C 3187	CHIP CAP.	0.01uF	50V	B	GRM188B11H103KA01D	K22174823		1-	B	b2
C 3190	CHIP CAP.	120pF	50V	CH	GRM1882C1H121JA01D	K22174237		1-	B	b3
C 3191	FILM CAP.	15pF	500V		UC232H0150J-T	K33279028		1-	B	a3
C 3192	FILM CAP.	4pF	500V		UC232H0040D-T	K33279044		1-	B	a3
C 3192	FILM CAP.	7pF	500V		UC232H0070D-T	K33279046		9-	B	a3
C 3192	FILM CAP.	10pF	500V		UC232H0100D-T	K33279019		14-	B	a3
C 3192	FILM CAP.	7pF	500V		UC232H0070D-T	K33279046		17-	B	a3
C 3192	FILM CAP.	10pF	500V		UC232H0100D-T	K33279019		25-	B	a3
C 3192	FILM CAP.	7pF	500V		UC232H0070D-T	K33279046		33-	B	a3
C 3194	CHIP CAP.	56pF	50V	CH	GRM1882C1H560JA01D	K22174229		1-	B	b3
C 3195	CHIP CAP.	0.001uF	50V	B	GRM188B11H102KA01D	K22174821		1-	A	F3
C 3197	CHIP CAP.	0.001uF	50V	B	GRM188B11H102KA01D	K22174821		73-	A	F3
C 3199	CHIP CAP.	120pF	50V	CH	GRM1882C1H121JA01D	K22174237		1-	B	b3
C 3200	FILM CAP.	27pF	500V		UC232H0270J-T	K33279023		1-	B	a2
C 3201	CHIP CAP.	680pF	500V	CH	CF43CH681J500AT	K22277218		1-	B	c3
C 3202	CHIP CAP.	18pF	200V	CH	GRM2192C2D180JV01D	K22230219		1	B	b2
C 3202	CHIP CAP.	27pF	200V	CH	GRM2192C2D270JV01D	K22230221		2-	B	b2
C 3202	CHIP CAP.	27pF	200V	CH	GRM2192C2D270JV01D	K22230221		4-	B	b2
C 3204	CHIP CAP.	680pF	500V	CH	CF43CH681J500AT	K22277218		1-	B	d2
C 3205	CHIP CAP.	180pF	200V	CH	GRM21B2C2D181JY21L	K22230231		1-	B	e3
C 3206	CHIP CAP.	150pF	500V	CH	CF32CH151J500AT	K22275249		1-	B	c2
C 3207	CHIP CAP.	82pF	200V	CH	GRM21B2C2D820JV01L	K22230227		1-	B	d3
C 3208	CHIP CAP.	68pF	200V	CH	GRM21B2C2D680JV01L	K22230226		1-	B	c2
C 3209	FILM CAP.	47pF	500V		UC232H0470J-T	K33279034		1-	A	F2
C 3211	CHIP CAP.	680pF	500V	CH	CF43CH681J500AT	K22277218		1-	B	c2

# PA Unit

## Parts List

REF	DESCRIPTION	VALUE	V/W	TOL.	MFR'S DESIG	VXSTD P/N	VERS.	LOT	SIDE	LAYADR
C 3212	CHIP CAP.	22pF	200V	CH	GRM2192C2D220JV01D	K22230220		1-	B	b2
C 3213	CHIP CAP.	180pF	200V	CH	GRM21B2C2D181JY21L	K22230231		1-	B	c2
C 3214	CHIP CAP.	100pF	200V	CH	GRM21B2C2D101JV01L	K22230228		1-	B	d2
C 3215	CHIP CAP.	39pF	200V	CH	GRM2192C2D390JV01D	K22230223		1-	B	e2
C 3216	CHIP CAP.	47pF	200V	CH	GRM2192C2D470JV01D	K22230224		1-	B	c2
C 3217	FILM CAP.	33pF	500V		UC232H0330J-T	K33279024		1-	B	d2
C 3217	FILM CAP.	39pF	500V		UC232H0390J-T	K33279038		10-	B	d2
C 3218	CHIP CAP.	33pF	200V	CH	GRM2192C2D330JV01D	K22230222		1-	B	c2
C 3219	FILM CAP.	15pF	500V		UC232H0150J-T	K33279028		1-	A	F2
C 3219	FILM CAP.	10pF	500V		UC232H0100D-T	K33279019		5-	A	F2
C 3220	FILM CAP.	18pF	500V		UC232H0180J-T	K33279029		1-	B	a2
C 3222	CHIP CAP.	56pF	200V	CH	GRM2192C2D560JV01D	K22230225		1-	B	b2
C 3223	FILM CAP.	12pF	500V		UC232H0120J-T	K33279020		1-	A	F2
C 3223	FILM CAP.	10pF	500V		UC232H0100D-T	K33279019		5-	A	F2
C 3224	CHIP CAP.	0.001uF	500V	CH	CF43CH102J500AT	K22277222		1-	B	c2
C 3225	CHIP CAP.	680pF	500V	CH	CF43CH681J500AT	K22277218		1-	B	d2
C 3226	CHIP CAP.	180pF	200V	CH	GRM21B2C2D181JY21L	K22230231		1-	B	c2
C 3227	CHIP CAP.	100pF	200V	CH	GRM21B2C2D101JV01L	K22230228		1-	B	d1
C 3228	CHIP CAP.	12pF	200V	CH	GRM2192C2D120JV01D	K22230217		1-	B	b2
C 3229	CHIP CAP.	680pF	500V	CH	CF43CH681J500AT	K22277218		1-	B	e1
C 3230	CHIP CAP.	220pF	500V	CH	CF43CH221J500AT	K22277206		1-	B	d2
C 3230	CHIP CAP.	180pF	500V	CH	CF43CH181J500AT	K22277204		21-	B	d2
C 3231	CHIP CAP.	220pF	200V	CH	GRM21B2C2D221JY21L	K22230232		1-	B	c2
C 3232	CHIP CAP.	0.001uF	50V	B	GRM188B11H102KA01D	K22174821		1-	B	b2
C 3233	CHIP CAP.	0.001uF	50V	B	GRM188B11H102KA01D	K22174821		1-	B	b2
C 3234	CHIP CAP.	0.001uF	50V	B	GRM188B11H102KA01D	K22174821		1-	B	b2
C 3235	CHIP CAP.	0.001uF	50V	B	GRM188B11H102KA01D	K22174821		1-	B	a2
C 3236	CHIP CAP.	470pF	500V	CH	CF43CH471J500AT	K22277214		1-	B	d2
C 3237	CHIP CAP.	22pF	200V	CH	GRM2192C2D220JV01D	K22230220		1-	B	c2
C 3238	CHIP CAP.	39pF	200V	CH	GRM2192C2D390JV01D	K22230223		1-	B	c1
C 3239	CHIP CAP.	0.001uF	500V	CH	CF43CH102J500AT	K22277222		1-	B	c2
C 3240	CHIP CAP.	68pF	200V	CH	GRM21B2C2D680JV01L	K22230226		1-	B	b2
C 3241	CHIP CAP.	470pF	500V	CH	CF43CH471J500AT	K22277214		1-	B	c1
C 3242	CHIP CAP.	270pF	500V	CH	CF43CH271J500AT	K22277208		1-	B	d2
C 3243	CHIP CAP.	100pF	200V	CH	GRM21B2C2D101JV01L	K22230228		1-	B	d1
C 3244	CHIP CAP.	120pF	200V	CH	GRM21B2C2D121JV01L	K22230229		1-	B	c1
C 3245	CHIP CAP.	18pF	200V	CH	GRM2192C2D180JV01D	K22230219		1-	B	e2
C 3245	CHIP CAP.	27pF	200V	CH	GRM2192C2D270JV01D	K22230221		4-6	B	e2
C 3245	CHIP CAP.	22pF	200V	CH	GRM2192C2D220JV01D	K22230220	W/ CE LABEL	7-	B	e2
C 3245	CHIP CAP.	18pF	200V	CH	GRM2192C2D180JV01D	K22230219	W/O CE LABEL	7-	B	e2
C 3246	CHIP CAP.	10pF	200V	CH	GRM2192C2D100JV01D	K22230216		1-	B	d1
C 3247	CHIP CAP.	0.01uF	50V	B	GRM188B11H103KA01D	K22174823		1-	B	b2
C 3248	CHIP CAP.	0.01uF	50V	B	GRM188B11H103KA01D	K22174823		1-	B	b2
C 3249	CHIP CAP.	3pF	200V	CJ	GRM2193C2D3R0CY21D	K22230210		1-	B	b1
C 3250	CHIP CAP.	0.001uF	50V	B	GRM188B11H102KA01D	K22174821		1-	B	b2
C 3251	CHIP CAP.	0.001uF	50V	B	GRM188B11H102KA01D	K22174821		1-	B	b2
C 3252	CHIP CAP.	0.001uF	500V	CH	CF43CH102J500AT	K22277222		1-	B	c1
C 3253	CHIP CAP.	560pF	500V	CH	CF43CH561J500AT	K22277216		1-	B	d1
C 3255	CHIP CAP.	150pF	200V	CH	GRM21B2C2D151JV01L	K22230230		1-	B	b2
C 3256	CHIP CAP.	82pF	200V	CH	GRM21B2C2D820JV01L	K22230227		1-	B	d1
C 3257	CHIP CAP.	12pF	200V	CH	GRM2192C2D120JV01D	K22230217		1-	B	d1
C 3258	CHIP CAP.	3pF	200V	CJ	GRM2193C2D3R0CY21D	K22230210		1-82	B	b1
C 3258	CHIP CAP.	3pF	200V	CJ	GRM2193C2D3R0CY21D	K22230210	VER A2 DST:EXP	83-85	B	b1
C 3258	CHIP CAP.	3pF	200V	CJ	GRM2193C2D3R0CY21D	K22230210	VERSION A1	83-85	B	b1
C 3258	CHIP CAP.	3pF	200V	CJ	GRM2193C2D3R0CY21D	K22230210	VERSION A2	83-85	B	b1
C 3258	CHIP CAP.	3pF	200V	CJ	GRM2193C2D3R0CY21D	K22230210	VERSION A3	83-85	B	b1
C 3258	CHIP CAP.	3pF	200V	CJ	GRM2193C2D3R0CY21D	K22230210	VERSION B1	83-85	B	b1
C 3258	CHIP CAP.	3pF	200V	CJ	GRM2193C2D3R0CY21D	K22230210	VERSION B2	83-85	B	b1
C 3258	CHIP CAP.	3pF	200V	CJ	GRM2193C2D3R0CY21D	K22230210	VERSION B3	83-85	B	b1
C 3258	CHIP CAP.	3pF	200V	CJ	GRM2193C2D3R0CY21D	K22230210	VERSION C1	83-85	B	b1
C 3258	CHIP CAP.	3pF	200V	CJ	GRM2193C2D3R0CY21D	K22230210	VERSION C2	83-85	B	b1
C 3258	CHIP CAP.	3pF	200V	CJ	GRM2193C2D3R0CY21D	K22230210	VERSION C3	83-85	B	b1
C 3258	CHIP CAP.	3pF	200V	CJ	GRM2193C2D3R0CY21D	K22230210	VERSION D1	83-85	B	b1
C 3258	CHIP CAP.	3pF	200V	CJ	GRM2193C2D3R0CY21D	K22230210	VERSION D2	83-85	B	b1
C 3258	CHIP CAP.	3pF	200V	CJ	GRM2193C2D3R0CY21D	K22230210	VERSION E1	83-85	B	b1
C 3258	CHIP CAP.	3pF	200V	CJ	GRM2193C2D3R0CY21D	K22230210	VERSION E2	83-85	B	b1
C 3258	CHIP CAP.	3pF	200V	CJ	GRM2193C2D3R0CY21D	K22230210	VERSION E3	83-85	B	b1
C 3258	CHIP CAP.	3pF	200V	CJ	GRM2193C2D3R0CY21D	K22230210	VERSION H1	83-85	B	b1
C 3258	CHIP CAP.	3pF	200V	CJ	GRM2193C2D3R0CY21D	K22230210	VERSION H2	83-85	B	b1
C 3258	CHIP CAP.	27pF	200V	CH	GRM2192C2D270JV01D	K22230221		86-	B	b1
C 3259	CHIP CAP.	0.5pF	50V	CK	GRM1884C1HR50CZ01D	K22174201		1-	A	G2
C 3259	CHIP CAP.	0.5pF	50V	CK	GRM1884C1HR50BZ01D	K22174265		14-	A	G2
C 3261	CHIP CAP.	2pF	50V	CK	GRM1884C1H2R0CZ01D	K22174203		1-103	B	a3

# PA Unit

## Parts List

REF	DESCRIPTION	VALUE	V/W	TOL.	MFR'S DESIG	VXSTD P/N	VERS.	LOT	SIDE	LAYADR
C 3262	CHIP CAP.	0.001uF	50V	B	GRM188B11H102KA01D	K22174821		1-	A	F2
C 3263	CHIP CAP.	22pF	50V	CH	GRM1882C1H220JA01D	K22174219		1-9	B	a3
C 3264	CHIP CAP.	0.01uF	50V	B	GRM188B11H103KA01D	K22174823		1-	B	c1
C 3265	CHIP CAP.	0.01uF	50V	B	GRM188B11H103KA01D	K22174823		1-	B	d1
C 3266	CHIP CAP.	0.01uF	50V	B	GRM188B11H103KA01D	K22174823		1-	B	e1
C 3267	CHIP CAP.	0.01uF	50V	B	GRM188B11H103KA01D	K22174823		1-	B	c1
C 3268	CHIP CAP.	0.01uF	50V	B	GRM188B11H103KA01D	K22174823		1-	B	d1
C 3269	CHIP CAP.	0.01uF	50V	B	GRM188B11H103KA01D	K22174823		1-	B	c1
C 3270	CHIP CAP.	0.01uF	50V	B	GRM188B11H103KA01D	K22174823		1-	B	b1
C 3271	CHIP CAP.	0.5pF	50V	CK	GRM1884C1HR50CZ01D	K22174201		1-	A	F1
C 3271	CHIP CAP.	0.5pF	50V	CK	GRM1884C1HR50BZ01D	K22174265		14-	A	F1
C 3273	CHIP CAP.	0.001uF	50V	B	GRM188B11H102KA01D	K22174821		1-	A	G1
C 3274	CHIP CAP.	220pF	50V	CH	GRM1882C1H221JA01D	K22174243		1-	A	F2
C 3275	CHIP CAP.	0.047uF	25V	F	GRM39F473Z25PT	K22145002		1-	A	F2
C 3275	CHIP CAP.	0.047uF	50V	F	GRM188F11H473ZA01D	K22175001		90-	A	F2
C 3276	CHIP CAP.	0.047uF	25V	F	GRM39F473Z25PT	K22145002		1-	A	F2
C 3276	CHIP CAP.	0.047uF	50V	F	GRM188F11H473ZA01D	K22175001		90-	A	F2
C 3277	CHIP CAP.	8pF	200V	CH	GRM2192C2D8R0DY21D	K22230214		1-	A	F1
C 3278	CHIP CAP.	220pF	50V	CH	GRM1882C1H221JA01D	K22174243		1-	A	F1
C 3279	CHIP CAP.	0.1uF	16V	B	GRM188B11C104KA01D	K22124805		1-	B	a1
C 3280	CHIP CAP.	0.1uF	16V	B	GRM188B11C104KA01D	K22124805		1-	B	a3
C 3281	CHIP CAP.	0.01uF	50V	B	GRM188B11H103KA01D	K22174823		1-	B	a3
C 3282	CHIP CAP.	0.001uF	50V	B	GRM188B11H102KA01D	K22174821		1-	B	a3
C 3283	CHIP CAP.	0.01uF	250V	X7R	GRM21BR72E103KW03L	K22240801		1-	B	a1
C 3284	CHIP CAP.	0.1uF	250V	X7R	GRM32DR72E104KW01L	K22245801		1-	B	b1
C 3285	CHIP CAP.	0.01uF	50V	B	GRM188B11H103KA01D	K22174823		1-	B	a1
C 3286	CHIP CAP.	0.01uF	50V	B	GRM188B11H103KA01D	K22174823		1-	B	a1
C 3287	CHIP CAP.	0.001uF	50V	B	GRM188B11H102KA01D	K22174821		1-	B	a1
C 3288	CHIP CAP.	47pF	200V	CH	GRM2192C2D470JV01D	K22230224		1-	A	F5
C 3289	CHIP CAP.	47pF	200V	CH	GRM2192C2D470JV01D	K22230224		1-	A	F5
C 3291	CHIP CAP.	0.1uF	16V	B	GRM188B11C104KA01D	K22124805		1-	B	f3
C 3292	CHIP CAP.	0.01uF	50V	B	GRM188B11H103KA01D	K22174823		1-	B	f3
C 3293	CHIP CAP.	0.01uF	50V	B	GRM188B11H103KA01D	K22174823		1-	A	A3
C 3294	CHIP CAP.	0.001uF	50V	B	GRM188B11H102KA01D	K22174821		1-	B	e3
C 3295	CHIP CAP.	22pF	50V	CH	GRM1882C1H220JA01D	K22174219		1-68	A	F6
C 3296	FILM CAP.	5pF	500V		UC232H0050D-T	K33279010		1-	A	F4
C 3296	FILM CAP.	6pF	500V		UC232H0060D-T	K33279045		73-	A	F4
C 3297	CHIP CAP.	8pF	200V	CH	GRM2192C2D8R0DY21D	K22230214		1-	B	b2
C 3298	CHIP CAP.	150pF	200V	CH	GRM21B2C2D151JV01L	K22230230		1-	B	c1
C 3299	CHIP CAP.	390pF	500V	CH	CF43CH391J500AT	K22277212		1-	B	e1
C 3300	CHIP CAP.	150pF	200V	CH	GRM21B2C2D151JV01L	K22230230		1-	B	e3
C 3302	CHIP CAP.	47pF	50V	CH	GRM1882C1H470JA01D	K22174227		1-	A	F2
C 3303	CHIP CAP.	0.001uF	50V	B	GRM188B11H102KA01D	K22174821		1-	A	F2
C 3304	CHIP CAP.	0.001uF	50V	B	GRM188B11H102KA01D	K22174821		1-	A	G1
C 3305	CHIP CAP.	1pF	200V	CK	GRM2194C2D1R0CY21D	K22230208		86-	A	F1
C 3306	CHIP CAP.	220pF	50V	CH	GRM1882C1H221JA01D	K22174243		1-	A	F3
C 3309	CHIP CAP.	220pF	50V	CH	GRM1882C1H221JA01D	K22174243		1-	A	F4
C 3310	CHIP CAP.	10pF	200V	CH	GRM2192C2D100JV01D	K22230216		1-	B	b2
C 3312	CHIP CAP.	10pF	200V	CH	GRM2192C2D100JV01D	K22230216		1-	B	c1
C 3313	FILM CAP.	10pF	500V		UC232H0100D-T	K33279019		2-68	A	G4
C 3316	FILM CAP.	10pF	500V		UC232H0100D-T	K33279019		69-	A	F4
C 3317	CHIP CAP.	100pF	200V	CH	GRM21B2C2D101JV01L	K22230228		1-	B	d2
C 3318	FILM CAP.	33pF	500V		UC232H0330J-T	K33279024		1	A	F5
C 3318	FILM CAP.	12pF	500V		UC232H0120J-T	K33279020		2-68	A	F5
C 3321	CHIP CAP.	0.1uF	25V	B	GRM21BB11E104KA01L	K22140811	W/ CE LABEL	4-	A	D3
C 3322	CHIP CAP.	0.01uF	50V	B	GRM188B11H103KA01D	K22174823	W/ CE LABEL	4-	A	D3
C 3323	CHIP CAP.	0.001uF	50V	B	GRM188B11H102KA01D	K22174821	W/ CE LABEL	4-	A	D3
C 3326	CHIP CAP.	0.001uF	50V	B	GRM188B11H102KA01D	K22174821	W/ CE LABEL	4-	A	A3
C 3327	CHIP CAP.	0.01uF	50V	B	GRM188B11H103KA01D	K22174823	W/ CE LABEL	4-	A	A3
C 3331	CHIP CAP.	0.1uF	16V	B	GRM188B11C104KA01D	K22124805	W/ CE LABEL	4-	A	A3
C 3332	CHIP CAP.	0.001uF	50V	B	GRM188B11H102KA01D	K22174821	W/ CE LABEL	4-	A	C4
C 3334	CHIP CAP.	0.01uF	50V	B	GRM188B11H103KA01D	K22174823	W/ CE LABEL	4-	B	d4
C 3335	CHIP CAP.	0.01uF	50V	B	GRM188B11H103KA01D	K22174823	W/ CE LABEL	4-	B	c4
C 3336	CHIP CAP.	0.001uF	50V	B	GRM188B11H102KA01D	K22174821	W/ CE LABEL	4-	B	d4
C 3337	CHIP CAP.	0.001uF	50V	B	GRM188B11H102KA01D	K22174821	W/ CE LABEL	4-	B	c4
C 3338	CHIP CAP.	0.001uF	50V	B	GRM188B11H102KA01D	K22174821	W/ CE LABEL	4-	A	C3
C 3351	AL.ELECTRO.CAP.	10uF	16V		RB2-16V100ME1#-T2	K46120011	W/ CE LABEL	4-		
C 3352	CHIP CAP.	1pF	50V	CK	GRM1884C1H1R0CZ01D	K22174202	EXPORT	4-	A	G2
C 3352	CHIP CAP.	1pF	50V	CK	GRM1884C1H1R0CZ01D	K22174202	FRANCE	4-	A	G2
C 3353	CHIP CAP.	7pF	200V	CH	GRM2192C2D7R0DY21D	K22230213		5-	A	F3
C 3355	CHIP CAP.	0.01uF	250V	X7R	GRM21BR72E103KW03L	K22240801		69-	B	a5
C 3357	CHIP CAP.	0.001uF	500V	W5R	CF316W5R102K500AT	K22271802		69-	B	a5
C 3357	CHIP CAP.	0.001uF	630V	R	GRM31BR32J102KY01L	K22281801		69-	B	a5

# PA Unit

## Parts List

REF	DESCRIPTION	VALUE	V/W	TOL.	MFR'S DESIG	VXSTD P/N	VERS.	LOT	SIDE	LAYADR
C 3358	AL.ELECTRO.CAP.	10uF	35V		RC2-35V100ME1#-T58	K46160005		105		
C 3358	AL.ELECTRO.CAP.	10uF	35V		RC2-35V100MD1#-F1	K40169025		106-		
D 3002	DIODE				BAS316	G2070716		1-	A	A2
D 3003	DIODE				DAP202K T146	G2070180		1-	A	D6
D 3004	DIODE				BAS316	G2070716		1-	A	B2
D 3005	DIODE				BAS316	G2070716		1-	B	f2
D 3006	DIODE				UDZ TE-17 16B	G2070578		1-	B	e3
D 3006	DIODE				UDZS TE-17 16B	G2070914		10-	B	e3
D 3007	DIODE				11ES1	G2090499		1-		
D 3007	DIODE				10EDB10	G2090781		27-68		
D 3008	DIODE				DAN202K T146	G2070182		1-68		
D 3009	DIODE				DAN202K T146	G2070182		1-	A	C6
D 3010	DIODE				11ES1	G2090499		1-	A	E5
D 3010	DIODE				10EDB10	G2090781		27-	A	E5
D 3011	DIODE				HSU277TRF-E	G2070118		1-	B	e3
D 3012	DIODE				DAP236U T106	G2070592		1-	A	D3
D 3013	DIODE				DAP236U T106	G2070592		1-	A	D3
D 3014	DIODE				DAP236U T106	G2070592		1-	B	b3
D 3015	DIODE				UM9957F/TR	G2070562		1-	A	F4
D 3015	DIODE				XB15A709A0HR	G2070826		19-	A	F4
D 3015	DIODE				L709CER	G2071124		72-	A	F4
D 3018	DIODE				UM9957F/TR	G2070562		1-	A	F4
D 3018	DIODE				XB15A709A0HR	G2070826		19-	A	F4
D 3018	DIODE				L709CER	G2071124		72-	A	F4
D 3020	DIODE				UM9957F/TR	G2070562		1-	A	F3
D 3020	DIODE				XB15A709A0HR	G2070826		19-	A	F3
D 3020	DIODE				L709CER	G2071124		72-	A	F3
D 3021	DIODE				UM9957F/TR	G2070562		1-	A	F4
D 3021	DIODE				XB15A709A0HR	G2070826		19-	A	F4
D 3021	DIODE				L709CER	G2071124		72-	A	F4
D 3022	DIODE				HSU277TRF-E	G2070118		1-	A	F4
D 3023	DIODE				UM9957F/TR	G2070562		1-	B	a3
D 3023	DIODE				XB15A709A0HR	G2070826		19-	B	a3
D 3023	DIODE				L709CER	G2071124		72-	B	a3
D 3024	DIODE				HSU277TRF-E	G2070118		1-	B	a3
D 3025	DIODE				BAS316	G2070716		1-	A	D3
D 3026	DIODE				BAS316	G2070716		1-	A	C3
D 3027	DIODE				BAS316	G2070716		1-	A	C3
D 3028	DIODE				BAS316	G2070716		1-	A	E3
D 3029	DIODE				BAS316	G2070716		1-	A	D3
D 3030	DIODE				BAS316	G2070716		1-	A	E3
D 3031	DIODE				BAS316	G2070716		1-	A	E3
D 3032	DIODE				BAS316	G2070716		1-	B	c3
D 3033	DIODE				BAS316	G2070716		1-	B	d3
D 3034	DIODE				BAS316	G2070716		1-	B	e3
D 3035	DIODE				BAS316	G2070716		1-	B	c3
D 3036	DIODE				BAS316	G2070716		1-	B	d3
D 3037	DIODE				BAS316	G2070716		1-	B	c3
D 3038	DIODE				BAS316	G2070716		1-	B	b2
D 3039	DIODE				UM9957F/TR	G2070562		1-	A	F3
D 3039	DIODE				MA4P1250	G2070974		25-	A	F3
D 3039	DIODE				UM9401F/TR	G2070516		35-	A	F3
D 3039	DIODE				UMX9401F	G2071214		89-	A	F3
D 3039	DIODE				L7101N	G2071274		129-	A	F3
D 3040	DIODE				DAN202K T146	G2070182		1-	B	b2
D 3041	DIODE				DAN202K T146	G2070182		1-	B	a2
D 3042	DIODE				RB751S-40TE61	G2070850		1-	A	F2
D 3043	DIODE				BAS316	G2070716		1-	B	c1
D 3044	DIODE				BAS316	G2070716		1-	B	d1
D 3045	DIODE				BAS316	G2070716		1-	B	e1
D 3046	DIODE				BAS316	G2070716		1-	B	c1
D 3047	DIODE				BAS316	G2070716		1-	B	d1
D 3048	DIODE				BAS316	G2070716		1-	B	d1
D 3049	DIODE				BAS316	G2070716		1-	B	b1
D 3050	DIODE				DAN235U TL	G2070176		1-	B	a3
D 3051	DIODE				RB751S-40TE61	G2070850		1-	A	G1
D 3052	DIODE				MA729-(TX)	G2070320		1-	A	F2
D 3053	DIODE				HSU277TRF-E	G2070118		1-	B	b3
D 3054	DIODE				MA729-(TX)	G2070320		1-	A	F1
D 3055	SURGE ABSORBER				RCCA-301Q43UA	Q9000756		1-	B	a1
D 3056	SURGE ABSORBER				RCCA-301Q43UA	Q9000756		1-	A	E1
D 3059	DIODE				DAN202K T146	G2070182		1-	A	B4
D 3060	DIODE				BAS316	G2070716		1-	B	f2

# PA Unit

## Parts List

REF	DESCRIPTION	VALUE	V/W	TOL.	MFR'S DESIG	VXSTD P/N	VERS.	LOT	SIDE	LAYADR
D 3061	DIODE				BAS316	G2070716		1-	B	e2
D 3062	DIODE				BAS316	G2070716		1-	A	B2
D 3063	DIODE				BAS316	G2070716		1-	B	e2
D 3064	DIODE				BAS316	G2070716		1-	A	A2
D 3065	DIODE				DAN202K T146	G2070182		1-	B	e3
D 3066	DIODE				HSU277TRF-E	G2070118		1-	A	F4
D 3067	DIODE				10E1	G2090306		1-3		
D 3100	DIODE				HSU277TRF-E	G2070118	W/ CE LABEL	4-68	B	b3
D 3100	DIODE				HSU277TRF-E	G2070118		69-	B	b3
FB3003	FERRITE BEADS				SMB304729	L9190094		1-	A	G6
FB3004	FERRITE BEADS				FB-43-801	L9190025		1-		
J 3002	CONNECTOR				24FLT-SM2-TB(LF)(SN)(M)	P1091128		1-	A	B6
J 3003	CONNECTOR				B2B-EH(LF)(SN)	P0090666		1-	A	A5
J 3004	CONNECTOR				B2B-EH(LF)(SN)	P0090666		1-	A	A5
J 3005	CONNECTOR				TMP-J01X-A2	P1090255	W/ CE LABEL	4-		
J 3005	CONNECTOR				TMP-S01X-C1	P1091254	W/ CE LABEL	101-		
J 3005	CONNECTOR				TMP-S01X-C1	P1091254	W/ CE LABEL	104-		
JP3001	WIRE ASSY				RED 150 TMP/TMP(B1)	T9318186		1-3	A	E6
JP3001	WIRE ASSY				RED 110 TMP/TMP	T9318196	W/ CE LABEL	4-	A	E6
JP3001	WIRE ASSY				RED 120 TMP/TMP	T9318199	W/ CE LABEL	12-	A	E6
JP3001	WIRE ASSY				RED 150 TMP/TMP(B1)	T9318186	W/O CE LABEL	4-	A	E6
JP3001	WIRE ASSY				RED 150 TMP/TMP(B1)	T9318186A	W/O CE LABEL	124-	A	E6
JP3002	WIRE ASSY				GRN 240 TMP/TMP(B1)	T9318185		1-3	A	F3
JP3002	WIRE ASSY				GRN 330 TMP/TMP(B1)	T9318195	W/ CE LABEL	4-	A	F3
JP3002	WIRE ASSY				GRN 330 TMP/TMP(B1)	T9318195A	W/ CE LABEL	124-	A	F3
JP3002	WIRE ASSY				GRN 240 TMP/TMP(B1)	T9318185	W/O CE LABEL	4-	A	F3
JP3002	WIRE ASSY				GRN 330 TMP/TMP(B1)	T9318207	W/O CE LABEL	24-	A	F3
JP3002	WIRE ASSY				GRN 330 TMP/TMP(B1)	T9318195	W/O CE LABEL	76-	A	F3
JP3002	WIRE ASSY				GRN 330 TMP/TMP(B1)	T9318195A	W/O CE LABEL	124-	A	F3
JP3003	WIRE ASSY				AH012M #242281	T9207006		1-		
JP3003	WIRE ASSY				AH012M #242299	T9207018		3-		
JP3004	WIRE ASSY				AH012M #242284	T9207009		1-		
JP3004	WIRE ASSY				AH012M #242300	T9207019		3		
JP3004	WIRE ASSY				AH012M	T9207020	W/ CE LABEL	4-		
JP3004	WIRE ASSY				AH012M #242300	T9207019	W/O CE LABEL	4-		
JP3004	WIRE ASSY				AH012M	T9207043	W/O CE LABEL	19-		
JP3005	WIRE ASSY				GRN 40 (3)/(3)	T51504012	W/ CE LABEL	4-68		
L 3001	COIL				E2 0.5-2.0-6T-R	L0022488		1-	A	F6
L 3002	COIL				E2 0.45-1.4-4T-L	L0022391		1-	A	F6
L 3003	COIL				E2 0.5-2.0-7T-R	L0022489		1-	A	F6
L 3004	COIL				E2 0.35-1.6-4.5T-L	L0022577		1-	A	F6
L 3005	COIL				E2 0.25-1.9-12T-L	L0022592		1-	A	E7
L 3006	COIL				E2 0.3-1.7-8T-L	L0022376		1-	A	F6
L 3008	COIL				E2 0.25-1.9-12.5T-L	L0022600		1-	A	E6
L 3009	COIL				E2 0.3-1.7-8T-L	L0022376		1-	A	F6
L 3010	COIL				E2 0.4-3.0-9.5T-L	L0022575		1-	A	E6
L 3011	COIL				E2 0.3-1.7-8T-L	L0022376		1-	A	F6
L 3012	COIL				E2 0.25-1.85-8.5T-L	L0022576		1-	A	D6
L 3013	M.RFC	0.0056uH			HK1608 5N6S-T	L1690513		1-	A	F6
L 3013	COIL				E2 0.3-0.9-3T-R	L0022389		69-	A	F6
L 3014	COIL				E2 0.45-1.4-4T-L	L0022391		1-	A	F6
L 3014	COIL				E2 0.35-1.6-4T-L	L0022456		69-	A	F6
L 3015	M.RFC	10uH			CDRH73NP-100MC	L1690598		1-	A	D6
L 3016	COIL				E2 0.4-3.0-9.5T-L	L0022575		1-	A	G6
L 3017	COIL	0.11uH			AS0810-B0NK	L0022542		1-	A	E4
L 3018	RFC WITH BEADS				3A RI5.8X6.4-2	L1020729		1-	A	A4
L 3019	RFC WITH BEADS				3A RI5.8X6.4-2	L1020729		1-	A	E4
L 3020	COIL	0.015uH			AS0803-15NK	L0022536		1-	A	G4
L 3023	CHIP COIL	4.7uH			C2520C-4R7K-RK	L1690735		1-	A	F4
L 3023	CHIP COIL	1uH		10% 2%	C2520C-1R0G-RA	L1691309		71-	A	F4
L 3024	M.RFC	4.7uH			LK2125 4R7K-T	L1690327		1-	A	D3
L 3025	COIL				E2 0.4-3.0-9.5T-L	L0022575		1-	A	F4
L 3026	M.RFC	0.47uH			LK2125 R47K-T	L1690315		1-	B	c3
L 3027	M.RFC	0.39uH			LK2125 R39K-T	L1690314		1-	B	c3
L 3029	COIL	0.047uH			AS0805-47NK	L0022539		1-	A	F3
L 3030	M.RFC	1.8uH			LK2125 1R8K-T	L1690322		1-	B	e3
L 3031	M.RFC	1uH			LK2125 1R0K-T	L1690319		1-	B	c3
L 3032	COIL A1				4.5T6.0D1.2UEW R	L0022150		1-	A	E3
L 3033	M.RFC	4.7uH			LK2125 4R7K-T	L1690327		1-	A	C3
L 3034	COIL	0.015uH			AS0803-15NK	L0022536		1-	A	F3
L 3035	M.RFC	1.8uH			LK2125 1R8K-T	L1690322		1-	B	d3
L 3036	M.RFC	1uH			LK2125 1R0K-T	L1690319		1-	B	c3
L 3037	M.RFC	0.47uH			LK2125 R47K-T	L1690315		1-	B	c3

# PA Unit

## Parts List

REF	DESCRIPTION	VALUE	V/W	TOL.	MFR'S DESIG	VXSTD P/N	VERS.	LOT	SIDE	LAYADR
L 3038	M.RFC	0.39uH			LK2125 R39K-T	L1690314		1-	B	c3
L 3039	M.RFC	4.7uH			LK2125 4R7K-T	L1690327		1-	A	C3
L 3040	COIL				E2 0.4-2.0-5.5T-L	L0022630		1-	A	F3
L 3041	COIL				E2 0.3-0.9-6T-R	L0022375		1-	A	F3
L 3042	COIL	0.01uH			AS1003-10NK	L0022544		1-	A	F3
L 3043	COIL	0.056uH			AS0806-56NK	L0022540		1-	A	G3
L 3044	COIL	0.047uH			AS0805-47NK	L0022539		1-	A	G3
L 3045	COIL	0.01uH			AS1003-10NK	L0022544		1-	A	F3
L 3046	M.RFC	0.18uH			LK2125 R18K-T	L1690310		1-	B	b3
L 3047	COIL	0.047uH			AS0805-47NK	L0022539		1-	A	G2
L 3048	M.RFC	0.18uH			LK2125 R18K-T	L1690310		1-	B	b3
L 3049	CHIPCOIL	4.7uH		10%	C2520C-4R7K-RK	L1690735		1-	A	F3
L 3050	COIL	0.047uH			AS0805-47NK	L0022539		1-	A	G2
L 3051	TOROIDAL COIL	0.114uH			0.114U T44-10	L0022569		1-	A	E2
L 3052	COIL	0.01uH			AS1003-10NK	L0022544		1-	A	F2
L 3053	TOROIDAL COIL	4.5uH			4.50U T44-2	L0022560		1-	A	D2
L 3054	TOROIDAL COIL	2.05uH			2.05U T44-2	L0022562		1-	A	C2
L 3055	TOROIDAL COIL	1.32uH			1.32U T44-2	L0022564A		1-	A	C2
L 3056	TOROIDAL COIL	0.558uH			0.558U T44-10	L0022566A		1-	A	D2
L 3057	TOROIDAL COIL	0.4uH			0.400U T44-10	L0022567		1-	A	D2
L 3058	COIL B1				6.0T8.0D0.8UJEW L	L0022570		1-	A	D2
L 3059	COIL	0.015uH			AS1203-15NK	L0022543		1-	A	F2
L 3060	COIL	0.022uH			AS1004-22NK	L0022545		1-	A	G2
L 3061	TOROIDAL COIL	0.146uH			0.146U T44-10	L0022568		1-	A	E2
L 3062	TOROIDAL COIL	3.6uH			3.60U T44-2	L0022561		1-	A	D1
L 3063	TOROIDAL COIL	1.57uH			1.57U T44-2	L0022563		1-	A	C2
L 3064	TOROIDAL COIL	1.11uH			1.11U T44-2	L0022565A		1-	A	C1
L 3065	TOROIDAL COIL	0.4uH			0.400U T44-10	L0022567		1-	A	D1
L 3066	COIL B1				9.0T8.5D0.9UJEW R	L0021856		1-	A	C2
L 3067	COIL B1				7.0T8.5D0.9UJEW R	L0021858		1-	A	D1
L 3068	TOROIDAL COIL	0.146uH			0.146U T44-10	L0022568		1-	A	E1
L 3069	M.RFC	4.7uH			ELJ-FC4R7KF	L1690348		1-	A	F2
L 3070	M.RFC	0.012uH			HK1608 12NJ-T	L1690517		1-	B	a3
L 3070	M.RFC	0.022uH			HK1608 22NJ-T	L1690520		104-	B	a3
L 3071	M.RFC	470uH			FLC32T-471J	L1690235		1-	A	F2
L 3072	M.RFC	4.7uH			ELJ-FC4R7KF	L1690348		1-	A	G1
L 3073	M.RFC	470uH			FLC32T-471J	L1690235		1-	A	F2
L 3074	M.RFC	120uH			RCH-875 121K	L1190396		1-	A	F1
L 3075	M.RFC	22uH			RCR875DNP-220L	L1190397		1-	A	F1
L 3076	TOROIDAL COIL	6uH			U 6H3 10X5X5	L0022039		1-	A	D5
L 3076	TOROIDAL COIL	6uH			6H3 TR10X5X5	L0022831		5-	A	D5
Q 3001	IC				TA75S01F(TE85R.F)	G1091593		1-	B	e3
Q 3002	TRANSISTOR				DTC323TK T146	G3070042		1-	B	f5
Q 3003	TRANSISTOR				2SC4154-T111-1E	G3341548E		1-	B	e5
Q 3003	TRANSISTOR				2SC4081 T106	G3340818		98-	B	e5
Q 3004	IC				KIA7805API	G1093163		1-	A	A4
Q 3005	IC				BU4094BCFV-E2	G1093527		1-	A	B5
Q 3005	IC				CD4094BPWR	G1093866		23-	A	B5
Q 3006	TRANSISTOR				2SC4154-T111-1E	G3341548E		1-	B	f4
Q 3006	TRANSISTOR				2SC4081 T106	G3340818		98-	B	f4
Q 3007	TRANSISTOR				DTC124GUA T106	G3070184		1-	B	f2
Q 3009	TRANSISTOR				2SC4154-T111-1E	G3341548E		1-	B	f4
Q 3009	TRANSISTOR				2SC4081 T106	G3340818		98-	B	f4
Q 3010	TRANSISTOR				DTC114TK T146	G3070073		1-	B	e3
Q 3011	TRANSISTOR				2SB1143S	G3211430S		1-	A	A4
Q 3012	TRANSISTOR				2SA812-T2B M5B	G3108127E		1-	A	A4
Q 3013	IC				BU4094BCFV-E2	G1093527		1-	A	B4
Q 3013	IC				CD4094BPWR	G1093866		23-	A	B4
Q 3014	TRANSISTOR				2SD1801S-TL	G3418018S		1-	A	C6
Q 3015	TRANSISTOR				2SD1801S-TL	G3418018S		1-68		
Q 3016	TRANSISTOR				2SC3102	G3331020		1-	A	F5
Q 3016	FET				RD70HVF1-101	G3090140		69-	A	F5
Q 3017	TRANSISTOR				2SC5125-21	G3351250		1-	A	E5
Q 3017	TRANSISTOR				2SC2782	G3327820		61-	A	E5
Q 3018	TRANSISTOR				2SC5125-21	G3351250		1-	A	C5
Q 3018	TRANSISTOR				2SC2782	G3327820		61-	A	C5
Q 3019	TRANSISTOR				DTC143ZUA T106	G3070188		1-	B	b1
Q 3020	TRANSISTOR				DTA113ZKA T146	G3070129		1-	A	B4
Q 3021	TRANSISTOR				DTA113ZKA T146	G3070129		1-	B	e6
Q 3022	TRANSISTOR				IMD3 T108	G3070053		1-	A	B5
Q 3023	TRANSISTOR				DTC143ZUA T106	G3070188		1-	A	B4
Q 3024	TRANSISTOR				DTC143ZUA T106	G3070188		1-	A	B4
Q 3026	TRANSISTOR				DTA113ZKA T146	G3070129		1-	A	B4



# PA Unit

## Parts List

REF	DESCRIPTION	VALUE	V/W	TOL.	MFR'S DESIG	VXSTD P/N	VERS.	LOT	SIDE	LAYADR
Q 3027	TRANSISTOR				2SB624-T2B BV4	G3206247D		1-	B	e5
Q 3028	TRANSISTOR				2SB624-T2B BV4	G3206247D		1-	B	e5
Q 3029	TRANSISTOR				DTC143ZUA T106	G3070188		1-	A	C3
Q 3030	TRANSISTOR				DTC143ZUA T106	G3070188		1-	A	B4
Q 3031	TRANSISTOR				DTC143ZUA T106	G3070188		1-	A	B4
Q 3032	TRANSISTOR				DTC143ZUA T106	G3070188		1-	A	C1
Q 3033	TRANSISTOR				DTC143ZUA T106	G3070188		1-	B	d3
Q 3034	TRANSISTOR				2SC5374-TL	G3353748		1-	A	E3
Q 3035	TRANSISTOR				IMH6A T108	G3070066		1-	B	a2
Q 3036	TRANSISTOR				DTC143ZUA T106	G3070188		1-	B	e3
Q 3037	TRANSISTOR				DTC124GUA T106	G3070184		1-	B	e3
Q 3038	TRANSISTOR				IMD3 T108	G3070053		1-	A	B5
Q 3040	FET				2SJ355-T1	G3703558		4-	B	e2
Q 3041	TRANSISTOR				FMG6 T98	G3070040		4-	B	e2
Q 3042	TRANSISTOR				DTC143ZUA T106	G3070188		86-	B	b1
R 3001	CHIPRES.	1k	1/16W	5%	RMC1/16 102JATP	J24185102		1-	B	e4
R 3002	CHIPRES.	470	1W	5%	RMC1 471JTE	J24305471		86-	A	E5
R 3003	CHIPRES.	0	1W	5%	RMC1 JPATE	J24305000		1-	A	E6
R 3003	CHIPRES.	10	1W	5%	RMC1 100JTE	J24305100		86-	A	E6
R 3004	CHIPRES.	180k	1/10W	0.5%	RR1220R-184-D-T5	J24209225		1-	B	e3
R 3005	CHIPRES.	10k	1/16W	5%	RMC1/16 103JATP	J24185103		1-	B	e4
R 3006	CHIPRES.	470	1W	5%	RMC1 471JTE	J24305471		86-	A	E6
R 3008	CHIPRES.	4.7k	1/16W	5%	RMC1/16 472JATP	J24185472		1-	B	e4
R 3009	CHIPRES.	180k	1/10W	0.5%	RR1220R-184-D-T5	J24209225		1-	B	e3
R 3010	CHIPRES.	1.5k	1/10W	0.1%	RR1220P-152-B	J24209078		1-	B	e3
R 3011	CHIPRES.	39	1/4W	5%	RMC1/4 390JATP	J24245390		1-	B	f5
R 3011	CHIPRES.	22	1W	5%	RMC1 220JTE	J24305220		4-	B	f5
R 3012	CHIPRES.	1.5k	1/10W	0.1%	RR1220P-152-B	J24209078		1-	B	e3
R 3013	CHIPRES.	1.5k	1/10W	0.1%	RR1220P-152-B	J24209078		1-	B	e3
R 3014	CHIPRES.	10k	1/10W	0.1%	RR1220P-103-B	J24209098		1-	B	e3
R 3015	CHIPRES.	1.5k	1/10W	0.1%	RR1220P-152-B	J24209078		1-	B	e3
R 3016	CHIPRES.	10k	1/10W	0.1%	RR1220P-103-B	J24209098		1-	B	e3
R 3018	CHIPRES.	47k	1/16W	5%	RMC1/16 473JATP	J24185473		1-	A	D6
R 3019	CHIPRES.	10k	1/16W	5%	RMC1/16 103JATP	J24185103		1-	B	e5
R 3020	CHIPRES.	2.2k	1/16W	5%	RMC1/16 222JATP	J24185222		1-	B	e5
R 3021	CHIPRES.	0	1/16W	5%	RMC1/16 000JATP	J24185000		1-	A	F6
R 3022	CHIPRES.	4.7k	1/16W	5%	RMC1/16 472JATP	J24185472		1-	A	D6
R 3023	CHIPRES.	4.7k	1/16W	5%	RMC1/16 472JATP	J24185472		1-	A	E6
R 3024	CHIPRES.	82k	1/16W	5%	RMC1/16 823JATP	J24185823		1-	A	D6
R 3025	CHIPRES.	3.9k	1/16W	1%	RMC1/16 392FTP	J24183392		1-	B	e4
R 3026	CHIPRES.	1k	1/16W	1%	RMC1/16 102FTP	J24183102		1-	B	f4
R 3027	CHIPRES.	10k	1/16W	5%	RMC1/16 103JATP	J24185103		1-	B	e3
R 3028	CHIPRES.	100	1/4W	5%	RMC1/4 101JATP	J24245101		1-	B	f5
R 3029	CHIPRES.	0	1/16W	5%	RMC1/16 000JATP	J24185000		1-	A	D6
R 3030	CHIPRES.	0	1/16W	5%	RMC1/16 000JATP	J24185000		1-	A	F6
R 3031	CHIPRES.	100	1/4W	5%	RMC1/4 101JATP	J24245101		1-	B	f4
R 3032	CHIPRES.	4.7k	1/16W	5%	RMC1/16 472JATP	J24185472		9-	B	e4
R 3033	CHIPRES.	1k	1/16W	5%	RMC1/16 102JATP	J24185102		1-	B	e3
R 3036	CHIPRES.	100	1/4W	5%	RMC1/4 101JATP	J24245101		1-	B	f4
R 3037	CHIPRES.	0.33	1W	10%	RMC1 R33KATE	J24309001		1-	B	f4
R 3040	CHIPRES.	3.3	1W	5%	RMC1 3R3JTE	J24305339		1-	A	E6
R 3041	CHIPRES.	2.2	1W	5%	RMC1 2R2JTE	J24305229		1-	A	E6
R 3042	CHIPRES.	3.3	1W	5%	RMC1 3R3JTE	J24305339		1-	A	C6
R 3043	CHIPRES.	2.2	1W	5%	RMC1 2R2JTE	J24305229		1-	A	C6
R 3044	CHIPRES.	220	1/16W	5%	RMC1/16 221JATP	J24185221		1-	A	F6
R 3045	CHIPRES.	3.9	1W	5%	RMC1 3R9JTE	J24305399		1-	B	c5
R 3048	CHIPRES.	0	1W	5%	RMC1 JPATE	J24305000		1-	B	c6
R 3051	CHIPRES.	0	1W	5%	RMC1 JPATE	J24305000		1-	B	d6
R 3054	CHIPRES.	3.9	1W	5%	RMC1 3R9JTE	J24305399		1-	B	d5
R 3055	CHIPRES.	100	1W	5%	RMC1 101JTE	J24305101		1-	B	d6
R 3056	CHIPRES.	56	1/10W	5%	RMC1/10T 560J	J24205560		1-	B	a6
R 3056	CHIPRES.	68	1W	5%	RMC1 680JTE	J24305680		69-	B	a6
R 3057	CHIPRES.	100	1/16W	5%	RMC1/16 101JATP	J24185101		1-	A	C7
R 3057	CHIPRES.	47	1/16W	5%	RMC1/16 470JATP	J24185470		61-	A	C7
R 3058	CHIPRES.	10	1/2W	5%	RMC1/2 100JCTP	J24275100		1-	B	b5
R 3059	CHIPRES.	10	1/2W	5%	RMC1/2 100JCTP	J24275100		1-	B	e5
R 3063	CHIPRES.	33	1W	5%	RMC1 330JTE	J24305330		1-	A	E4
R 3064	CHIPRES.	1.5k	1/16W	5%	RMC1/16 152JATP	J24185152		1-	B	d3
R 3065	CHIPRES.	1.5k	1/16W	5%	RMC1/16 152JATP	J24185152		1-	B	e3
R 3066	CHIPRES.	1.5k	1/16W	5%	RMC1/16 152JATP	J24185152		1-	B	c3
R 3067	CHIPRES.	1.5k	1/16W	5%	RMC1/16 152JATP	J24185152		1-	B	c3
R 3068	CHIPRES.	1.5k	1/16W	5%	RMC1/16 152JATP	J24185152		1-	B	b3
R 3069	CHIPRES.	1.5k	1/16W	5%	RMC1/16 152JATP	J24185152		1-	B	b2

# PA Unit

## Parts List

REF	DESCRIPTION	VALUE	V/W	TOL.	MFR'S DESIG	VXSTD P/N	VERS.	LOT	SIDE	LAYADR
R 3071	CHIPRES.	33	1W	5%	RMC1 330JTE	J24305330		1-	A	E4
R 3073	CHIPRES.	1.5k	1/16W	5%	RMC1/16 152JATP	J24185152		1-	B	c3
R 3074	CHIPRES.	0	1/16W	5%	RMC1/16 000JATP	J24185000		1-	A	F3
R 3075	CHIPRES.	0	1/16W	5%	RMC1/16 000JATP	J24185000		1-	A	G3
R 3076	CHIPRES.	68	1/16W	5%	RMC1/16 680JATP	J24185680		1-	A	E3
R 3077	CHIPRES.	6.8k	1/16W	5%	RMC1/16 682JATP	J24185682		1-	B	b3
R 3078	CHIPRES.	33k	1/16W	5%	RMC1/16 333JATP	J24185333		1-	B	b3
R 3079	CHIPRES.	56	1W	5%	RMC1 560JTE	J24305560		1-	A	E4
R 3080	CHIPRES.	0	1/16W	5%	RMC1/16 000JATP	J24185000		1-	A	F3
R 3081	CHIPRES.	0	1/16W	5%	RMC1/16 000JATP	J24185000		1-	A	F3
R 3082	CHIPRES.	0	1/16W	5%	RMC1/16 000JATP	J24185000		1-	B	b4
R 3084	CHIPRES.	10k	1/16W	5%	RMC1/16 103JATP	J24185103		1-	B	b3
R 3085	CHIPRES.	10k	1/16W	5%	RMC1/16 103JATP	J24185103		1-	B	b3
R 3086	CHIPRES.	10k	1/16W	5%	RMC1/16 103JATP	J24185103		1-	B	b3
R 3087	CHIPRES.	1.5k	1/16W	5%	RMC1/16 152JATP	J24185152		1-	B	b3
R 3088	CHIPRES.	1k	1/16W	5%	RMC1/16 102JATP	J24185102		1-	B	a3
R 3089	CHIPRES.	1k	1/16W	5%	RMC1/16 102JATP	J24185102		1-	B	a3
R 3092	CHIPRES.	1.8k	1/16W	5%	RMC1/16 182JATP	J24185182		1-	B	b2
R 3092	CHIPRES.	1.8k	1/16W	5%	RMC1/16 182JATP	J24185182		4-	B	b2
R 3093	CHIPRES.	1k	1/16W	5%	RMC1/16 102JATP	J24185102		1-	B	a2
R 3094	CHIPRES.	1k	1/16W	5%	RMC1/16 102JATP	J24185102		1-	B	a2
R 3096	CHIPRES.	27	1/16W	5%	RMC1/16 270JATP	J24185270		1-	A	F1
R 3097	CHIPRES.	4.7k	1/16W	5%	RMC1/16 472JATP	J24185472		1-	A	F2
R 3098	CHIPRES.	56	1/2W	5%	RMC1/2 560JTE	J24275560		1-	B	b1
R 3099	CHIPRES.	56	1/2W	5%	RMC1/2 560JTE	J24275560		1-	A	F1
R 3102	CHIPRES.	47k	1/16W	5%	RMC1/16 473JATP	J24185473		1-	B	a1
R 3103	CHIPRES.	56	1/2W	5%	RMC1/2 560JTE	J24275560		1-	B	b1
R 3104	CHIPRES.	56	1/2W	5%	RMC1/2 560JTE	J24275560		1-	A	F1
R 3105	CHIPRES.	10k	1/16W	5%	RMC1/16 103JATP	J24185103		1-	A	F2
R 3106	CHIPRES.	1.5k	1/16W	5%	RMC1/16 152JATP	J24185152		1-	B	a3
R 3107	CHIPRES.	4.7k	1/16W	5%	RMC1/16 472JATP	J24185472		1-	A	F2
R 3108	CHIPRES.	47k	1/16W	5%	RMC1/16 473JATP	J24185473		1-	B	b1
R 3109	CHIPRES.	0	1/16W	5%	RMC1/16 000JATP	J24185000		1-	B	f5
R 3114	CHIPRES.	0	1/16W	5%	RMC1/16 000JATP	J24185000		1-	A	F6
R 3115	CHIPRES.	100k	1/16W	5%	RMC1/16 104JATP	J24185104		1-	B	e6
R 3117	CHIPRES.	100k	1/16W	5%	RMC1/16 104JATP	J24185104		1-	A	B6
R 3118	CHIPRES.	10k	1/16W	5%	RMC1/16 103JATP	J24185103		1-	B	e3
R 3119	CHIPRES.	2.2k	1/16W	5%	RMC1/16 222JATP	J24185222		1-	A	B5
R 3120	CHIPRES.	2.2k	1/16W	5%	RMC1/16 222JATP	J24185222		1-	A	B5
R 3123	CHIPRES.	330	1W	5%	RMC1 331JTE	J24305331		1-	B	c6
R 3124	CHIPRES.	330	1W	5%	RMC1 331JTE	J24305331		1-	B	c6
R 3127	CHIPRES.	39	1/4W	5%	RMC1/4 390JATP	J24245390		1-3		
R 3128	CHIPRES.	100	1/16W	5%	RMC1/16 101JATP	J24185101		1-	A	G1
R 3129	CARBON FILM RES.	2.2k	1/6W	5%	RD16PJ222 2.2K	J01225222		1-	A	E3
R 3129	CHIPRES.	2.2k	1/16W	5%	RMC1/16 222JATP	J24185222		4	A	E3
R 3129	CHIPRES.	1k	1/16W	5%	RMC1/16 102JATP	J24185102		5-	A	E3
R 3130	CARBON FILM RES.	470	1/6W	5%	RD16PJ471 470	J01225471		1-	B	c3
R 3130	CHIPRES.	470	1/16W	5%	RMC1/16 471JATP	J24185471		4-	B	c3
R 3131	CARBON FILM RES.	470	1/6W	5%	RD16PJ471 470	J01225471		1-	A	A4
R 3131	CHIPRES.	1k	1/16W	5%	RMC1/16 102JATP	J24185102		4-	A	A4
R 3132	CHIPRES.	470k	1/16W	5%	RMC1/16 474JATP	J24185474		4-	B	e2
R 3133	CHIPRES.	100k	1/16W	5%	RMC1/16 104JATP	J24185104		4-	B	e2
R 3134	CHIPRES.	470	1/16W	5%	RMC1/16 471JATP	J24185471		4-	A	E4
R 3135	CHIPRES.	4.7	1W	5%	RMC1 4R7JTE	J24305479		69-	B	b5
R 3136	CHIPRES.	4.7	1W	5%	RMC1 4R7JTE	J24305479		69-	B	b6
R 3137	CHIPRES.	68	1W	5%	RMC1 680JTE	J24305680		69-	B	a5
R 3138	CHIPRES.	390	1/16W	5%	RMC1/16 391JATP	J24185391		69-	A	G6
R 3139	CHIPRES.	22k	1/16W	5%	RMC1/16 223JATP	J24185223		69-	A	F6
R 3140	CHIPRES.	1	1W	5%	RMC1 1R0JTE	J24305010		69-	A	F6
R 3141	CHIPRES.	1	1W	5%	RMC1 1R0JTE	J24305010		69-	A	F6
R 3142	CHIPRES.	1	1W	5%	RMC1 1R0JTE	J24305010		69-	A	F6
R 3143	CHIPRES.	10k	1/16W	5%	RMC1/16 103JATP	J24185103		86-	B	b1
RL3001	RELAY		DC12V		ACT512 DC12V	M1190176		1-	A	B2
RL3002	RELAY		DC12V		G5V-1 DC12V	M1190120		1-	A	D3
RL3003	RELAY		DC12V		G5V-1 DC12V	M1190120		1-	A	C3
RL3004	RELAY		DC12V		G5V-1 DC12V	M1190120		1-	A	C3
RL3005	RELAY		DC12V		G5V-1 DC12V	M1190120		1-	A	D3
RL3006	RELAY		DC12V		G5V-1 DC12V	M1190120		1-	A	D3
RL3007	RELAY		DC12V		G5V-1 DC12V	M1190120		1-	A	E3
RL3008	RELAY		DC12V		AG201344 DC12V	M1190124		1-	A	E3
RL3009	RELAY		DC12V		G5V-1 DC12V	M1190120		1-	A	D1
RL3010	RELAY		DC12V		G5V-1 DC12V	M1190120		1-	A	C1
RL3011	RELAY		DC12V		G5V-1 DC12V	M1190120		1-	A	C1

# PA Unit

## Parts List

REF	DESCRIPTION	VALUE	V/W	TOL.	MFR'S DESIG	VXSTD P/N	VERS.	LOT	SIDE	LAYADR
RL3012	RELAY		DC12V		G5V-1 DC12V	M1190120		1-	A	E1
RL3013	RELAY		DC12V		G5V-1 DC12V	M1190120		1-	A	C1
RL3014	RELAY		DC12V		G5V-1 DC12V	M1190120		1-	A	D1
RL3015	RELAY		DC12V		AG201344 DC12V	M1190124		1-	A	E1
T 3001	TOROIDAL COIL				D12A RI16X8X8(H007)	L0022745		1-3	A	B1
T 3002	TOROIDAL COIL				D12A RI16X8X8(H007)	L0022745		1-	A	B3
T 3003	COIL PWR-WIDE				3A5 RIB10	L0022791		1-	A	D6
T 3005	COIL PWR-WIDE				3A5 RIB16X32X22	L0022688		1-	A	D4
T 3005	COIL PWR-WIDE				D12A RIB16X32X22	L0022832		16-	A	D4
T 3006	COIL WIDE-TRANS.				3-318707	L0022619		1-	A	E3
T 3007	COIL WIDE-TRANS.				#223093	L0022792		1-	A	F1
TC3001	TRIMMERCAP.	20pF			ECR-JA020E11X	K91000228		1-	A	F5
TC3002	TRIMMERCAP.	20pF			ECR-JA020E11X	K91000228		1-	A	F1
TH3001	THERMISTOR				157-502-53002TP	G9090049		1-	A	D5
TH3002	THERMISTOR				157-502-53002TP	G9090049		1-	A	E5
TP3021	TERMINAL				TP-E/MS-60124	Q5000016		1-	A	C3
TP3022	TERMINAL				TP-E/MS-60124	Q5000016		1-	A	C3
VR3001	POT.	470			EVN-5ESX50BQ2	J51811471		1-	A	G6
VR3002	POT.	470			EVN-5ESX50BQ2	J51811471		1-	A	C7
VR3003	POT.	220			EVN-5ESX50BE2	J51811221		1-	A	G2
	PACKING PAD				(GAP P)	RA0398300		1-15		
	LEAF SPRING					RA0129800	W/ CE LABEL	4-		
	GROUND PLATE					RA0015200	W/ CE LABEL	4-68		
	GROUND PLATE					RA0015200	W/ CE LABEL	4-68		
	LEAF SPRING					RA0129800		19-		
	LEAF SPRING					R0140031		73-		
	GROUND PLATE					RA0415200		73-		
	GROUND PLATE					RA0415200		73-		

## *PA Unit*

*Note:*

Circuit Diagram

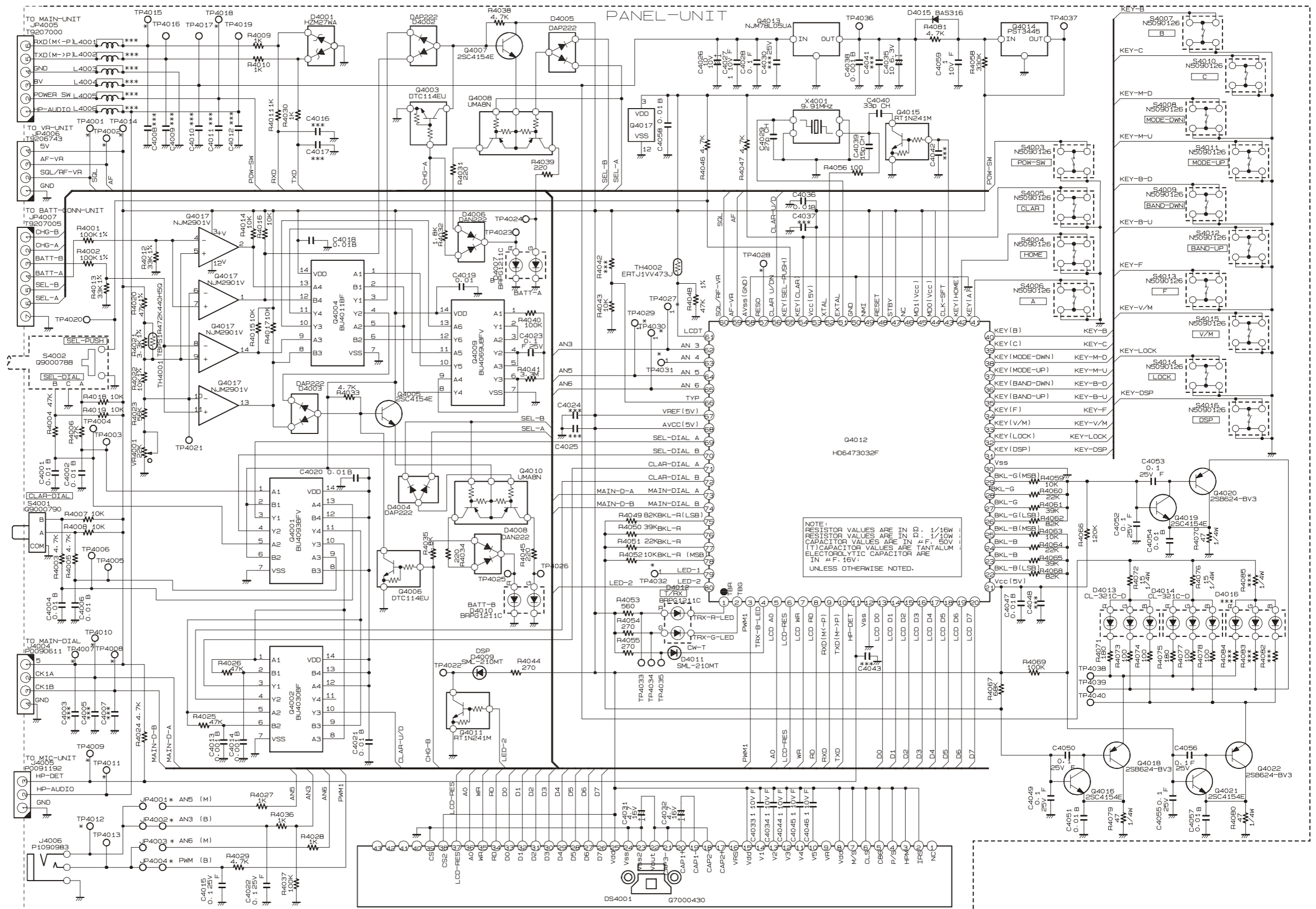

*PANEL Unit (Lot. 1 ~ 2)*

*Note:*

Parts Layout

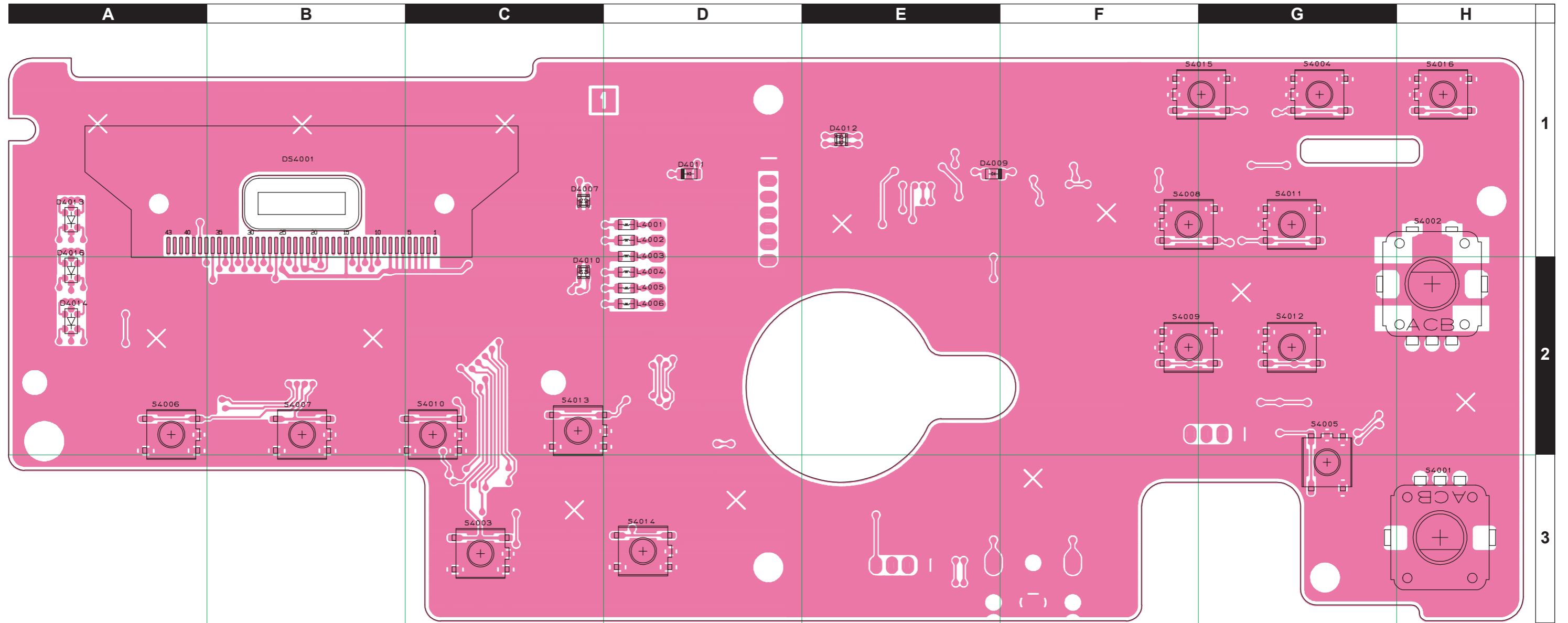

Side A

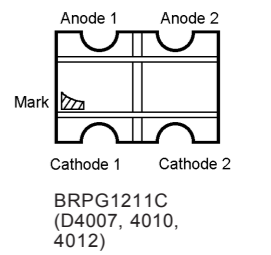

# PANEL Unit (Lot. 1 ~ 2)

## Parts Layout

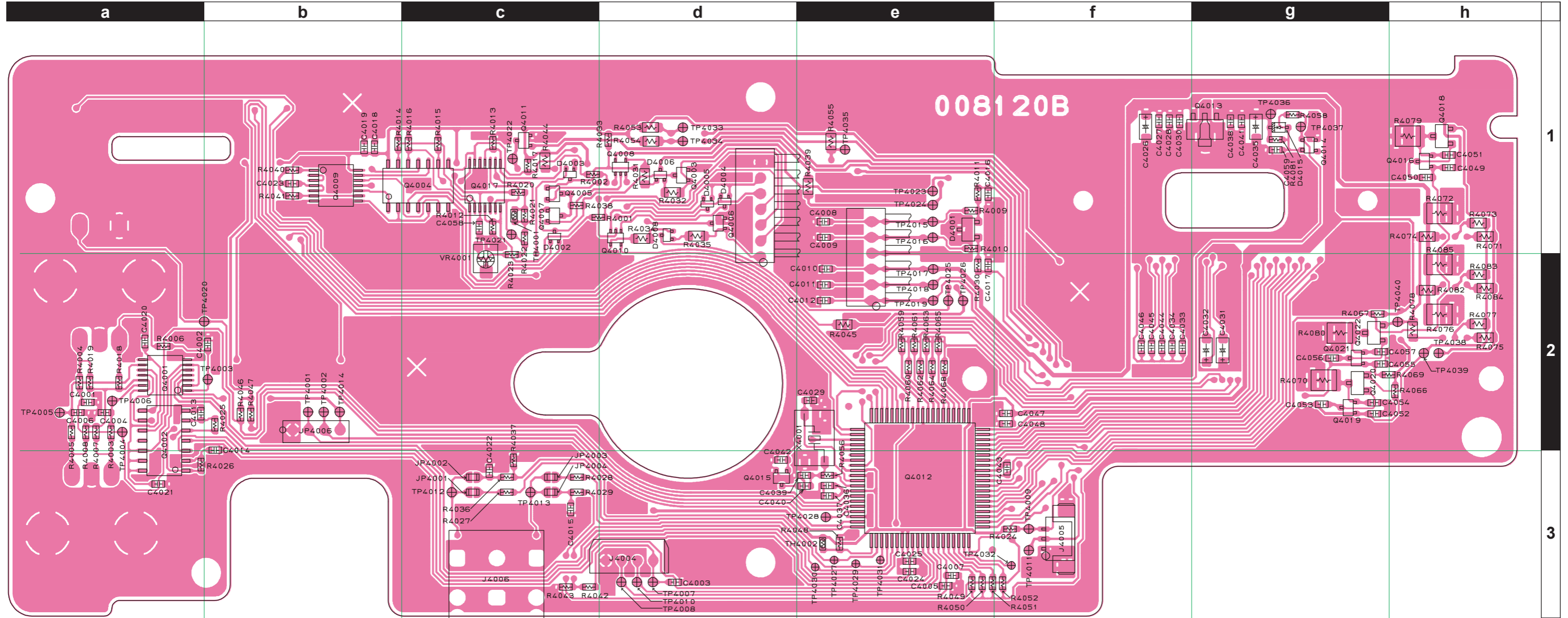

Side B

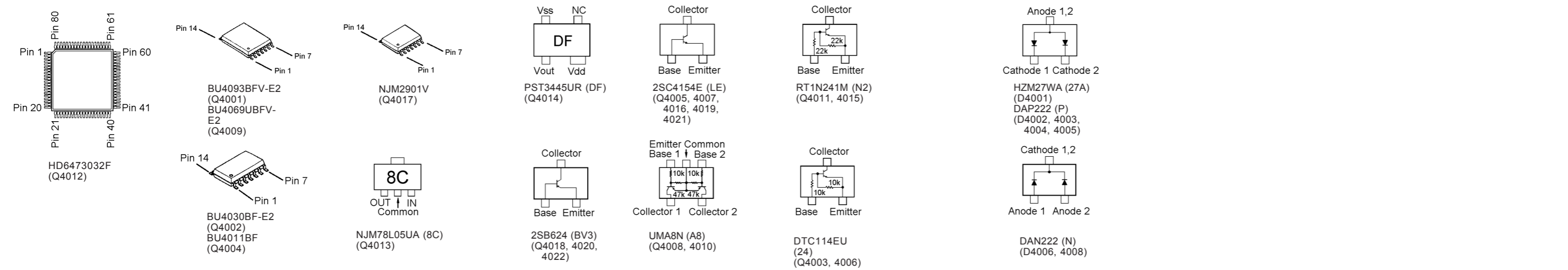



Circuit Diagram

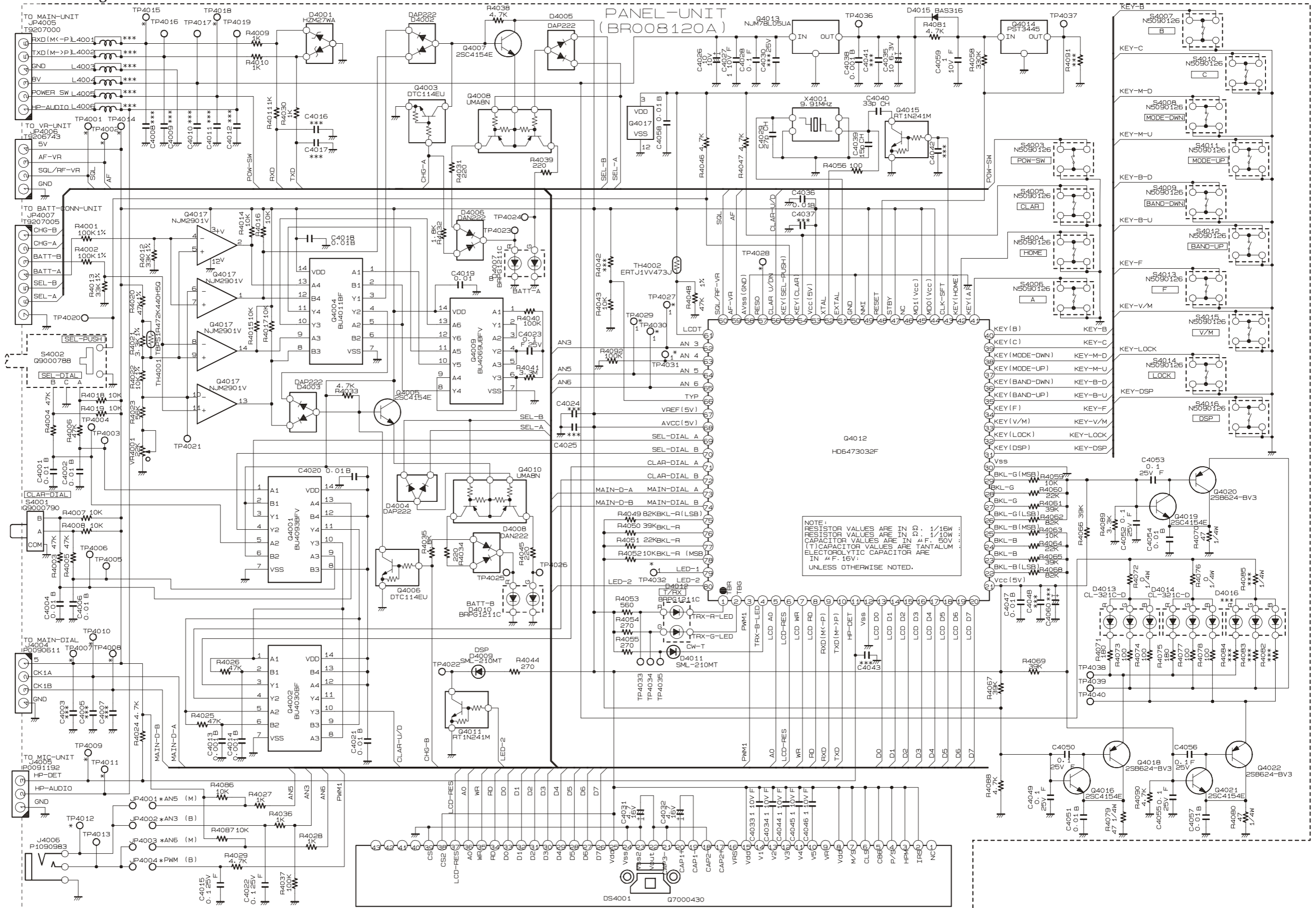

*PANEL Unit (Lot. 3 ~ 11)*

*Note:*

Parts Layout

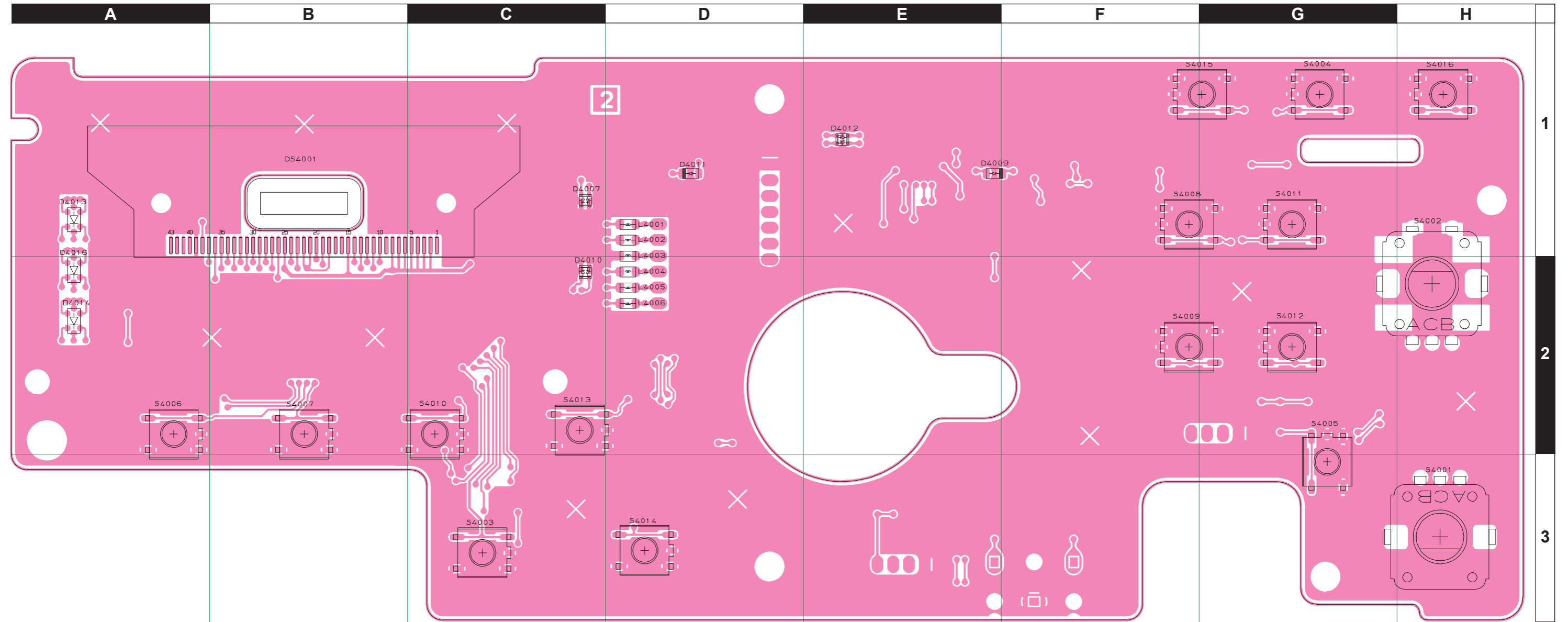

Side A

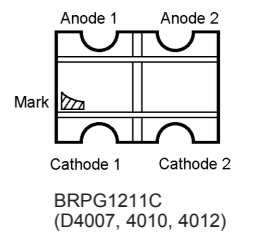

# PANEL Unit (Lot. 3 ~ 11)

## Parts Layout

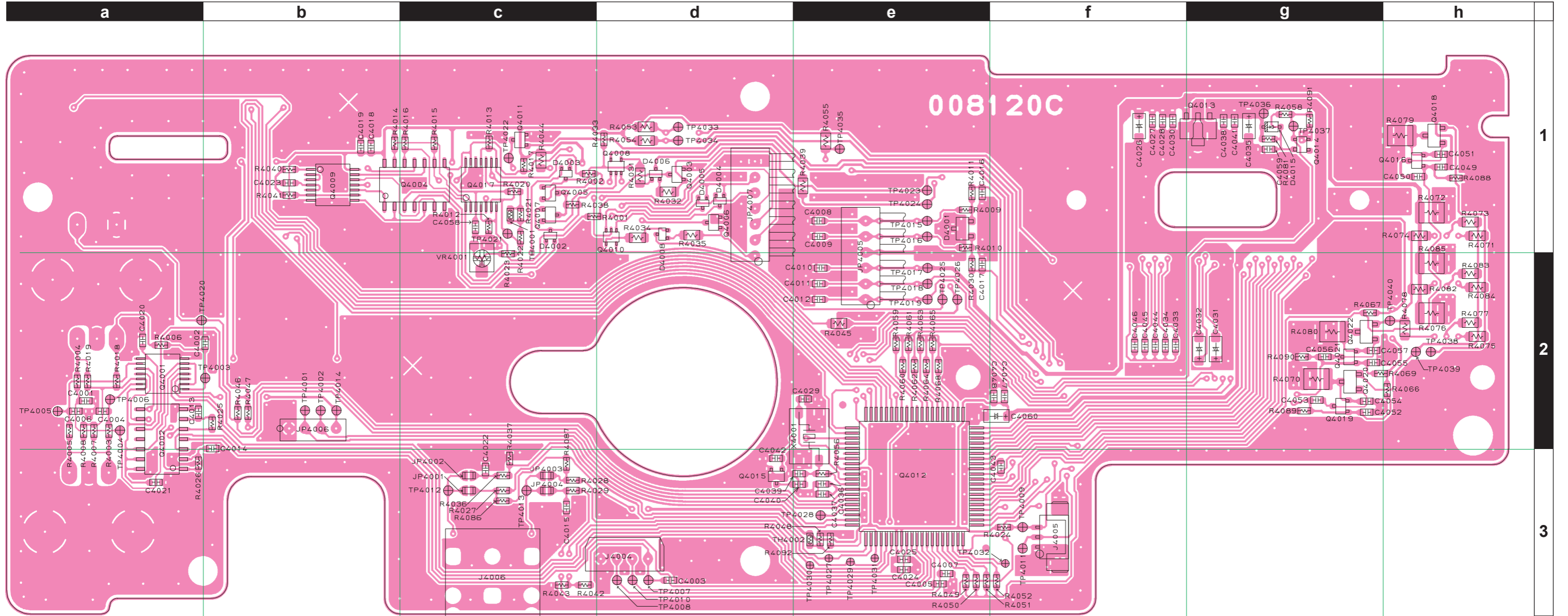

Side B

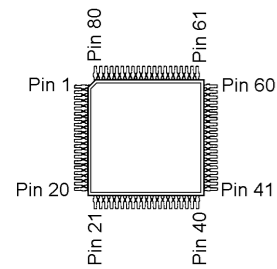

HD6473032F (Q4012)

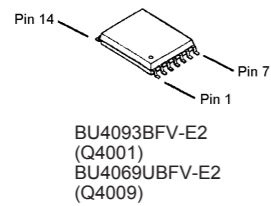

BU4093BFV-E2 (Q4001)  
BU4069UBFV-E2 (Q4009)

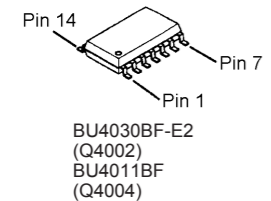

BU4030BF-E2 (Q4002)  
BU4011BF (Q4004)

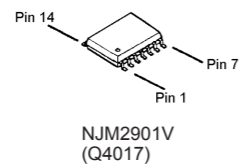

NJM2901V (Q4017)

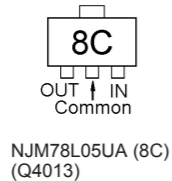

NJM78L05UA (8C) (Q4013)

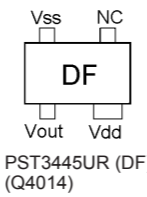

PST3445UR (DF) (Q4014)

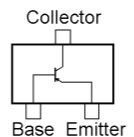

2SB624 (BV3) (Q4018, 4020, 4022)

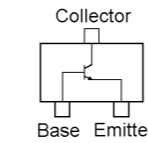

2SC4154E (LE) (Q4005, 4007, 4016, 4019, 4021)

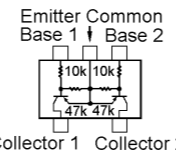

UMA8N (A8) (Q4008, 4010)

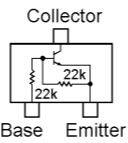

RT1N241M (N2) (Q4011, 4015)

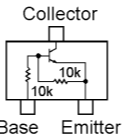

DTC114EU (24) (Q4003, 4006)

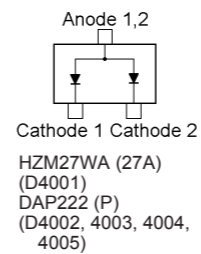

HZM27WA (27A) (D4001)  
DAP222 (P) (D4002, 4003, 4004, 4005)

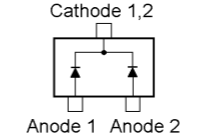

DAN222 (N) (D4006, 4008)

Circuit Diagram

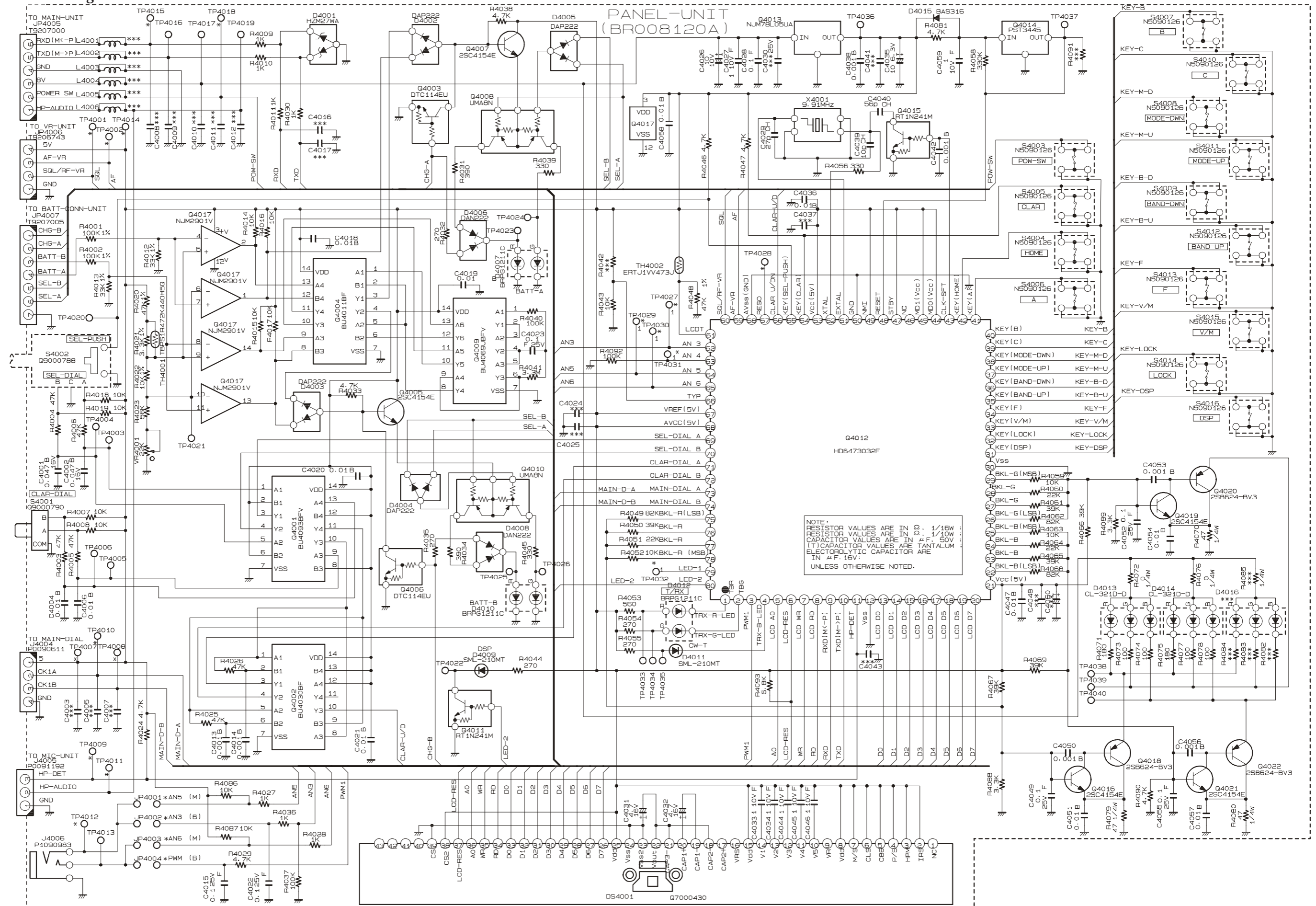

*PANEL Unit (Lot. 12)*

*Note:*

Parts Layout

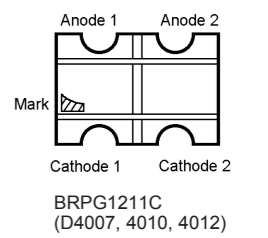
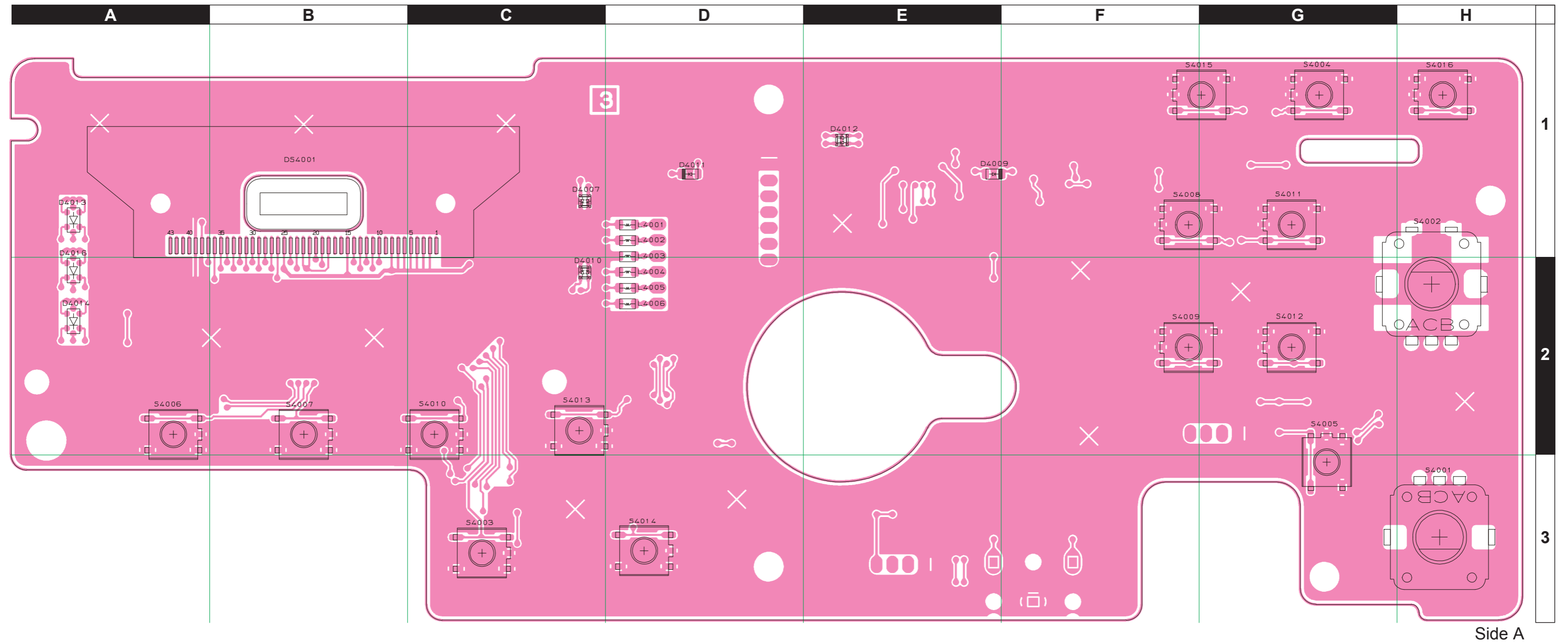

# PANEL Unit (Lot. 12)

## Parts Layout

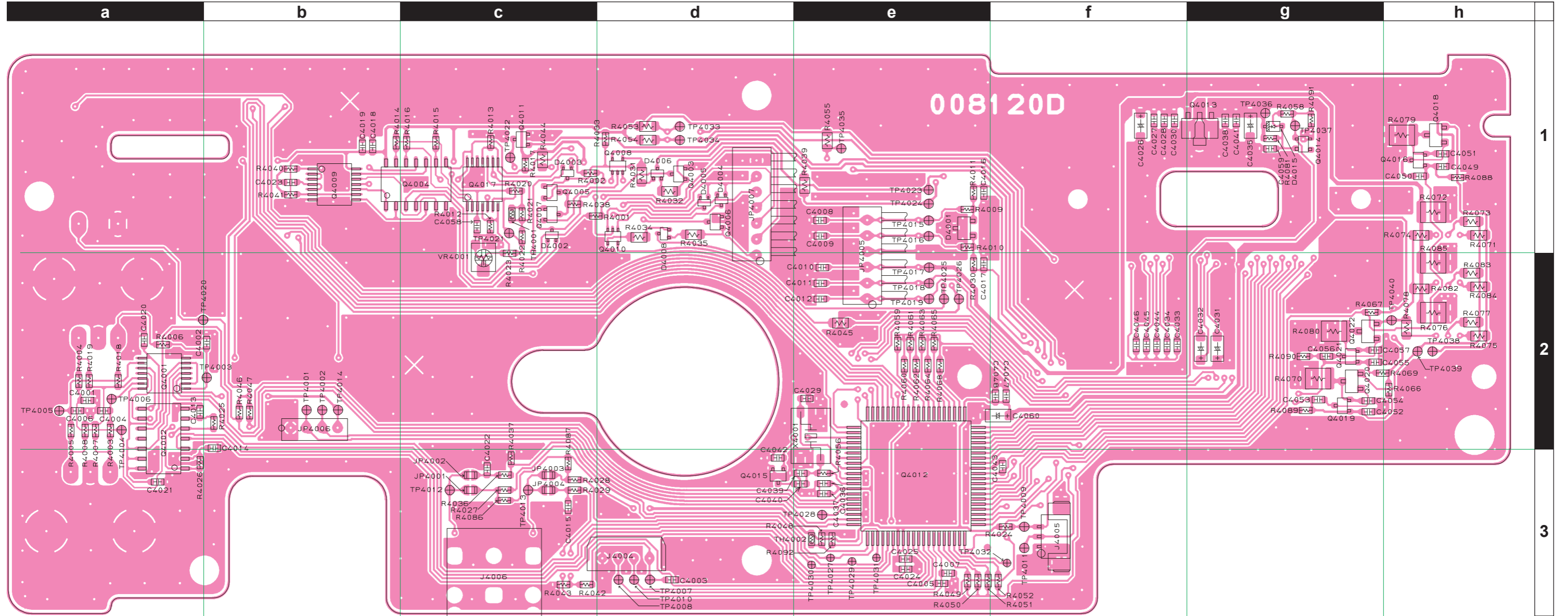

### Side B

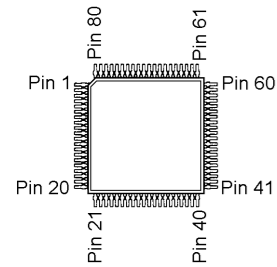

HD6473032F (Lot. 1~)  
HD6433032ST09F (Lot. 17~)  
(Q4012)

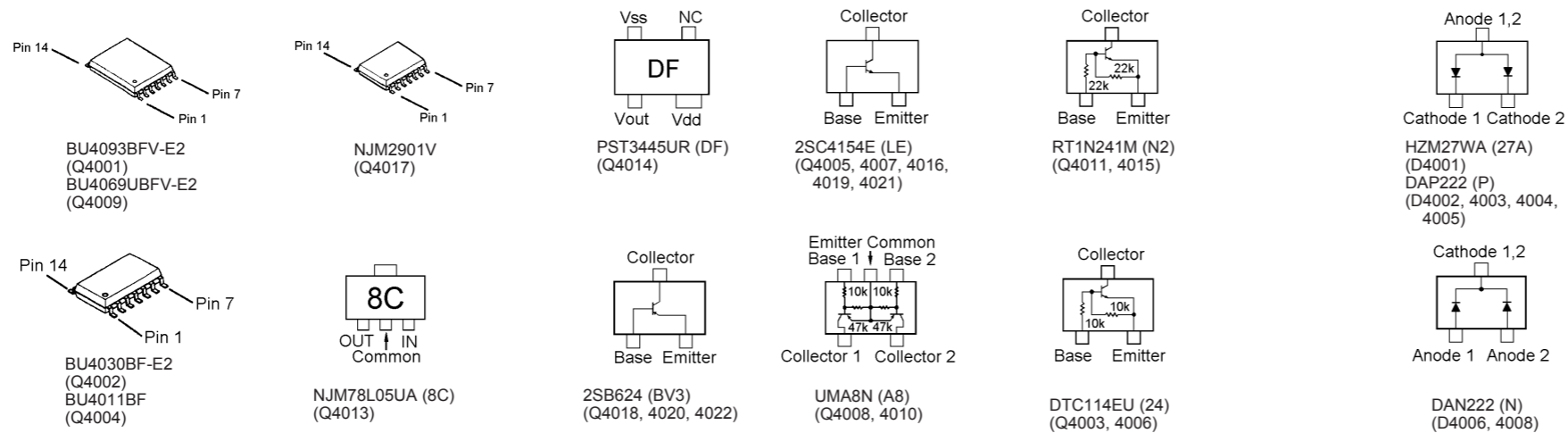





*PANEL Unit (Lot. 13 ~)*

*Note:*

Parts Layout

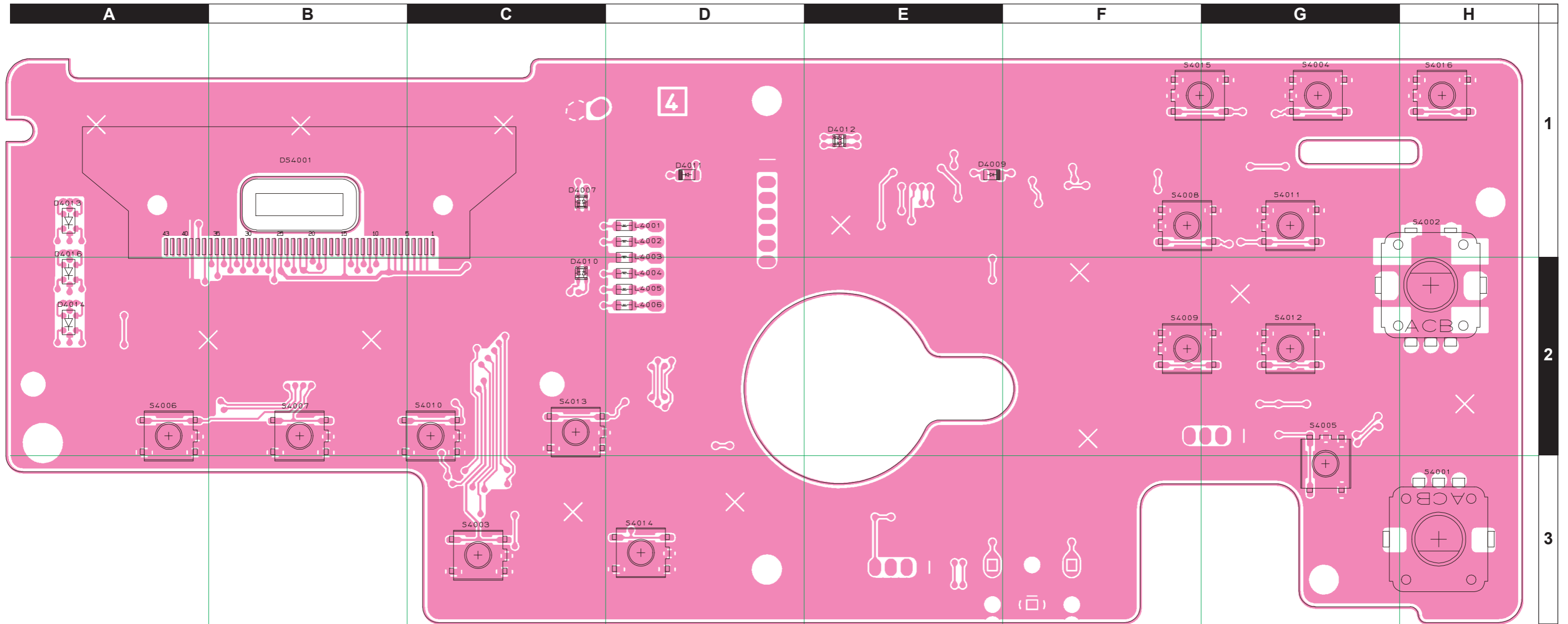

Side A

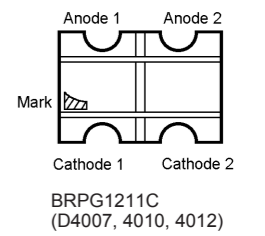

# PANEL Unit (Lot. 13~)

## Parts Layout

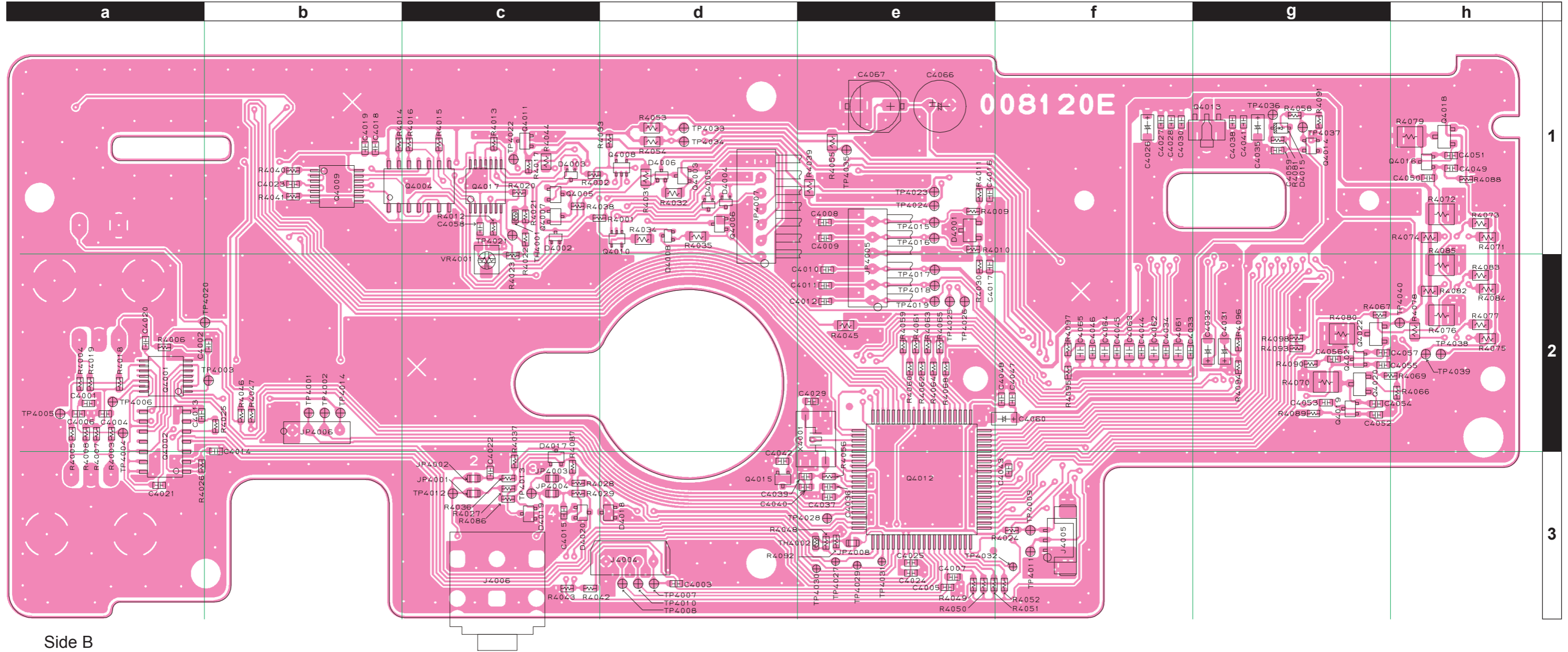

Side B

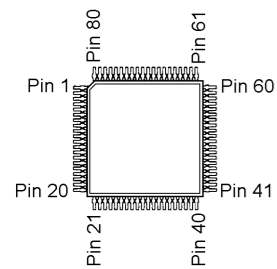

HD6473032F (Lot. 1~)  
HD6433032ST09F (Lot. 17~)  
(Q4012)

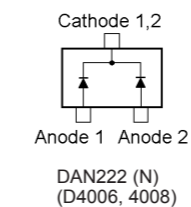
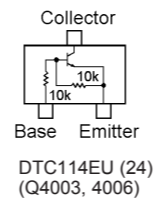
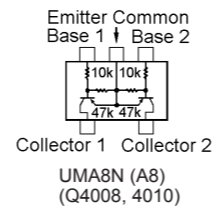
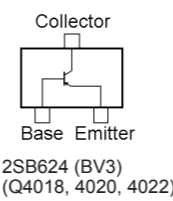
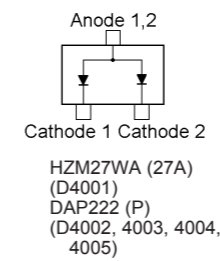
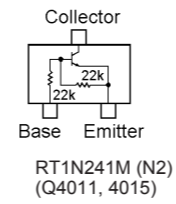
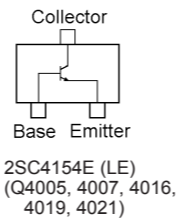
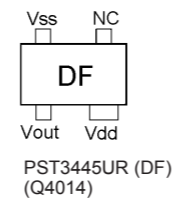
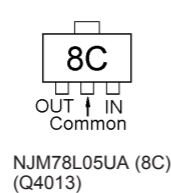
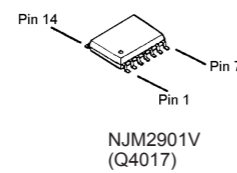
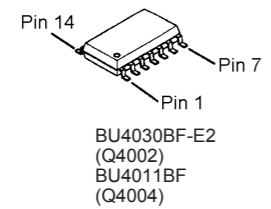
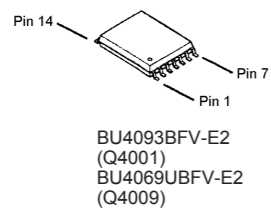

# PANEL Unit

## Parts List

REF	DESCRIPTION	VALUE	V/W	TOL.	MFR'S DESIG	VXSTD P/N	VERS.	LOT	SIDE	LAYADR
PCB with Components						CB1998001				
Printed Circuit Board						FR008120C		1-11		
						FR008120D		12		
						FR008120E		13-		
C 4001	CHIP CAP.	0.047uF	16V	B	GRM39B473K16PT	K22124804		1-	B	a2
C 4001	CHIP CAP.	0.047uF	25V	B	GRM188B11E473KA01D	K22144811		98-	B	a2
C 4002	CHIP CAP.	0.047uF	16V	B	GRM39B473K16PT	K22124804		1-	B	b2
C 4002	CHIP CAP.	0.047uF	25V	B	GRM188B11E473KA01D	K22144811		98-	B	b2
C 4004	CHIP CAP.	0.01uF	50V	B	GRM188B11H103KA01D	K22174823		1-	B	a2
C 4006	CHIP CAP.	0.01uF	50V	B	GRM188B11H103KA01D	K22174823		1-	B	a2
C 4013	CHIP CAP.	0.001uF	50V	B	GRM188B11H102KA01D	K22174821		1-	B	a2
C 4014	CHIP CAP.	0.001uF	50V	B	GRM188B11H102KA01D	K22174821		1-	B	b2
C 4015	CHIP CAP.	0.1uF	25V	F	GRM188F11E104ZA01D	K22145001		1-	B	c3
C 4018	CHIP CAP.	0.01uF	50V	B	GRM188B11H103KA01D	K22174823		1-	B	b1
C 4019	CHIP CAP.	0.01uF	50V	B	GRM188B11H103KA01D	K22174823		1-	B	b1
C 4020	CHIP CAP.	0.01uF	50V	B	GRM188B11H103KA01D	K22174823		1-	B	a2
C 4021	CHIP CAP.	0.01uF	50V	B	GRM188B11H103KA01D	K22174823		1-	B	a3
C 4022	CHIP CAP.	0.1uF	25V	F	GRM188F11E104ZA01D	K22145001		1-	B	c3
C 4023	CHIP CAP.	0.1uF	25V	F	GRM188F11E104ZA01D	K22145001		1-	B	b1
C 4026	CHIP TA.CAP.	10uF	10V		TEESVA1A106M8R	K78100028		1-	B	f1
C 4027	CHIP CAP.	1uF	10V	F	GRM188F11A105ZA01D	K22105001		1-	B	f1
C 4028	CHIP CAP.	0.1uF	25V	F	GRM188F11E104ZA01D	K22145001		1-	B	f1
C 4029	CHIP CAP.	27pF	50V	CH	GRM188C1H270JA01D	K22174221		1-	B	e2
C 4031	CHIP TA.CAP.	4.7uF	16V		TEESVA1C475M8R	K78120031		1-	B	g2
C 4032	CHIP TA.CAP.	4.7uF	16V		TEESVA1C475M8R	K78120031		1-	B	g2
C 4033	CHIP CAP.	1uF	10V	F	GRM188F11A105ZA01D	K22105001		1-	B	f2
C 4033	CHIP CAP.	1uF	10V	F	GRM188F11A105ZA01D	K22105001		5-	B	f2
C 4033	CHIP TA.CAP.	2.2uF	10V		F921A225MJA	K78100068		10-	B	f2
C 4033	CHIP CAP.	2.2uF	10V	B	GRM188B31A225KE18D	K22104805		13-	B	f2
C 4034	CHIP CAP.	1uF	10V	F	GRM188F11A105ZA01D	K22105001		1-	B	f2
C 4034	CHIP CAP.	1uF	10V	F	GRM188F11A105ZA01D	K22105001		5-	B	f2
C 4034	CHIP TA.CAP.	2.2uF	10V		F921A225MJA	K78100068		10-	B	f2
C 4034	CHIP CAP.	2.2uF	10V	B	GRM188B31A225KE18D	K22104805		13-	B	f2
C 4035	CHIP TA.CAP.	10uF	6.3V		TEESVA0J106M8R	K78080027		1-	B	g1
C 4036	CHIP CAP.	0.01uF	50V	B	GRM188B11H103KA01D	K22174823		1-	B	e3
C 4038	CHIP CAP.	0.001uF	50V	B	GRM188B11H102KA01D	K22174821		1-	B	g1
C 4039	CHIP CAP.	10pF	50V	CH	GRM188C1H100JA01D	K22174211		1-	B	e3
C 4040	CHIP CAP.	56pF	50V	CH	GRM188C1H560JA01D	K22174229		1-	B	e3
C 4042	CHIP CAP.	0.001uF	50V	B	GRM188B11H102KA01D	K22174821		1-	B	d3
C 4044	CHIP CAP.	1uF	10V	F	GRM188F11A105ZA01D	K22105001		1-	B	f2
C 4044	CHIP CAP.	1uF	10V	F	GRM188F11A105ZA01D	K22105001		5-	B	f2
C 4044	CHIP TA.CAP.	2.2uF	10V		F921A225MJA	K78100068		10-	B	f2
C 4044	CHIP CAP.	2.2uF	10V	B	GRM188B31A225KE18D	K22104805		13-	B	f2
C 4045	CHIP CAP.	1uF	10V	F	GRM188F11A105ZA01D	K22105001		1-	B	f2
C 4045	CHIP CAP.	1uF	10V	F	GRM188F11A105ZA01D	K22105001		5-	B	f2
C 4045	CHIP TA.CAP.	2.2uF	10V		F921A225MJA	K78100068		10-	B	f2
C 4045	CHIP CAP.	2.2uF	10V	B	GRM188B31A225KE18D	K22104805		13-	B	f2
C 4046	CHIP CAP.	1uF	10V	F	GRM188F11A105ZA01D	K22105001		1-	B	f2
C 4046	CHIP CAP.	1uF	10V	F	GRM188F11A105ZA01D	K22105001		5-	B	f2
C 4046	CHIP TA.CAP.	2.2uF	10V		F921A225MJA	K78100068		10-	B	f2
C 4046	CHIP CAP.	2.2uF	10V	B	GRM188B31A225KE18D	K22104805		13-	B	f2
C 4047	CHIP CAP.	0.01uF	50V	B	GRM188B11H103KA01D	K22174823		1-	B	f2
C 4049	CHIP CAP.	0.1uF	25V	F	GRM188F11E104ZA01D	K22145001		1-	B	h1
C 4050	CHIP CAP.	0.001uF	50V	B	GRM188B11H102KA01D	K22174821		1-	B	h1
C 4051	CHIP CAP.	0.01uF	50V	B	GRM188B11H103KA01D	K22174823		1-	B	h1
C 4052	CHIP CAP.	0.1uF	25V	F	GRM188F11E104ZA01D	K22145001		1-	B	g2
C 4053	CHIP CAP.	0.001uF	50V	B	GRM188B11H102KA01D	K22174821		1-	B	g2
C 4054	CHIP CAP.	0.01uF	50V	B	GRM188B11H103KA01D	K22174823		1-	B	g2
C 4055	CHIP CAP.	0.1uF	25V	F	GRM188F11E104ZA01D	K22145001		1-	B	g2
C 4056	CHIP CAP.	0.001uF	50V	B	GRM188B11H102KA01D	K22174821		1-	B	g2
C 4057	CHIP CAP.	0.01uF	50V	B	GRM188B11H103KA01D	K22174823		1-	B	g2
C 4058	CHIP CAP.	0.01uF	50V	B	GRM188B11H103KA01D	K22174823		1-	B	c1
C 4059	CHIP CAP.	1uF	10V	F	GRM188F11A105ZA01D	K22105001		1-	B	g1
D 4001	DIODE				HZM27WA TR-E	G2070530		1-	B	e1
D 4002	DIODE				DAP222-TL	G2070432		1-	B	c1
D 4003	DIODE				DAP222-TL	G2070432		1-	B	c1
D 4004	DIODE				DAP222-TL	G2070432		1-	B	d1
D 4005	DIODE				DAP222-TL	G2070432		1-	B	d1
D 4006	DIODE				DAN222 TL	G2070174		1-	B	d1
D 4007	LED				BRPG1211C-TR	G2070654		1-	A	C1
D 4008	DIODE				DAN222 TL	G2070174		1-	B	d1
D 4009	LED				SML-210MTT86	G2070524		1-	A	E1
D 4010	LED				BRPG1211C-TR	G2070654		1-	A	C2

# PANEL Unit

## Parts List

REF	DESCRIPTION	VALUE	V/W	TOL.	MFR'S DESIG	VXSTD P/N	VERS.	LOT	SIDE	LAYADR
D 4011	LED				SML-210MTT86	G2070524		1-	A	D1
D 4012	LED				BRPG1211C-TR	G2070654		1-	A	E1
D 4013	LED				CL-321D-D-T	G2070904		1-	A	A1
D 4013	LED				CL-321G-D-T	G2071008		31-	A	A1
D 4014	LED				CL-321D-D-T	G2070904		1-	A	A2
D 4014	LED				CL-321G-D-T	G2071008		31-	A	A2
D 4015	DIODE				BAS316	G2070716		1-	B	g1
DS4001	LCD MODULE				NCM1705A	Q7000430		1-	A	B1
J 4004	CONNECTOR				SB20-04WS	P0090611		1-	B	d3
J 4005	CONNECTOR				53398-0390	P0091192		1-	B	f3
J 4006	CONNECTOR				HSJ6062-01-440	P1090983		1-	B	c3
JP4002	CHIPRES.	0	1/16W	5%	RMC1/16 000JATP	J24185000		1-	B	c3
JP4004	CHIPRES.	0	1/16W	5%	RMC1/16 000JATP	J24185000		1-	B	c3
JP4005	WIRE ASSY				AH012M #242274	T9207000		1-	B	e2
JP4006	WIRE ASSY				A0898	T9206743		1-	B	b2
JP4007	WIRE ASSY				AH012M #242279	T9207005		1-	B	d2
JP4599	WIRE ASSY				GRN 40 (3)/(3)	T51504012		1-2		
Q 4001	IC				BU4093BFV-E2	G1093549		1-	B	a2
Q 4002	IC				BU4030BF-E2	G1093550		1-	B	a2
Q 4003	TRANSISTOR				DTC114EUA T106	G3070084		1-	B	d1
Q 4004	IC				BU4011BF-E2	G1092724		1-	B	c1
Q 4005	TRANSISTOR				2SC4154-T111-1E	G3341548E		1-	B	c1
Q 4005	TRANSISTOR				2SC4081 T106	G3340818		98-	B	c1
Q 4006	TRANSISTOR				DTC114EUA T106	G3070084		1-	B	d1
Q 4007	TRANSISTOR				2SC4154-T111-1E	G3341548E		1-	B	c1
Q 4007	TRANSISTOR				2SC4081 T106	G3340818		98-	B	c1
Q 4008	TRANSISTOR				UMA8N TR	G3070270		1-	B	d1
Q 4009	IC				BU4069UBFV-E2	G1093601		1-	B	b1
Q 4010	TRANSISTOR				UMA8N TR	G3070270		1-	B	d1
Q 4011	TRANSISTOR				RT1N241M-T11-1	G3070249		1-	B	c1
Q 4011	TRANSISTOR				DTC124EU T106	G3070045		98-	B	c1
Q 4012	IC				HD6473032F			1-	B	e3
Q 4012	IC				HD6473032F R0717			8-	B	e3
Q 4012	IC				HD6433032ST09F			17-	B	e3
Q 4013	IC				NJM78L05UA-TE1	G1091325		1-	B	g1
Q 4014	IC				PST3445UR	G1093232		1-	B	g1
Q 4015	TRANSISTOR				RT1N241M-T11-1	G3070249		1-	B	d3
Q 4015	TRANSISTOR				DTC124EU T106	G3070045		98-	B	d3
Q 4016	TRANSISTOR				2SC4154-T111-1E	G3341548E		1-	B	h1
Q 4016	TRANSISTOR				2SC4081 T106	G3340818		98-	B	h1
Q 4017	IC				NJM2901V-TE1	G1092779		1-	B	c1
Q 4018	TRANSISTOR				2SB624-T2B BV3	G3206247C		1-	B	h1
Q 4019	TRANSISTOR				2SC4154-T111-1E	G3341548E		1-	B	g2
Q 4019	TRANSISTOR				2SC4081 T106	G3340818		98-	B	g2
Q 4020	TRANSISTOR				2SB624-T2B BV3	G3206247C		1-	B	g2
Q 4021	TRANSISTOR				2SC4154-T111-1E	G3341548E		1-	B	g2
Q 4021	TRANSISTOR				2SC4081 T106	G3340818		98-	B	g2
Q 4022	TRANSISTOR				2SB624-T2B BV3	G3206247C		1-	B	g2
R 4001	CHIPRES.	100k	1/16W	1%	RMC1/16 104FTP	J24183104		1-	B	c1
R 4002	CHIPRES.	100k	1/16W	1%	RMC1/16 104FTP	J24183104		1-	B	c1
R 4003	CHIPRES.	47k	1/16W	5%	RMC1/16 473JATP	J24185473		1-	B	a2
R 4004	CHIPRES.	47k	1/16W	5%	RMC1/16 473JATP	J24185473		1-	B	a2
R 4005	CHIPRES.	47k	1/16W	5%	RMC1/16 473JATP	J24185473		1-	B	a2
R 4006	CHIPRES.	47k	1/16W	5%	RMC1/16 473JATP	J24185473		1-	B	a2
R 4007	CHIPRES.	10k	1/16W	5%	RMC1/16 103JATP	J24185103		1-	B	a2
R 4008	CHIPRES.	10k	1/16W	5%	RMC1/16 103JATP	J24185103		1-	B	a2
R 4009	CHIPRES.	1k	1/16W	5%	RMC1/16 102JATP	J24185102		1-	B	e1
R 4010	CHIPRES.	1k	1/16W	5%	RMC1/16 102JATP	J24185102		1-	B	e1
R 4011	CHIPRES.	1k	1/16W	5%	RMC1/16 102JATP	J24185102		1-	B	e1
R 4012	CHIPRES.	33k	1/16W	1%	RMC1/16 333FTP	J24183333		1-	B	c1
R 4013	CHIPRES.	33k	1/16W	1%	RMC1/16 333FTP	J24183333		1-	B	c1
R 4014	CHIPRES.	10k	1/16W	5%	RMC1/16 103JATP	J24185103		1-	B	b1
R 4015	CHIPRES.	10k	1/16W	5%	RMC1/16 103JATP	J24185103		1-	B	c1
R 4016	CHIPRES.	10k	1/16W	5%	RMC1/16 103JATP	J24185103		1-	B	c1
R 4017	CHIPRES.	10k	1/16W	5%	RMC1/16 103JATP	J24185103		1-	B	c1
R 4018	CHIPRES.	10k	1/16W	5%	RMC1/16 103JATP	J24185103		1-	B	a2
R 4019	CHIPRES.	10k	1/16W	5%	RMC1/16 103JATP	J24185103		1-	B	a2
R 4020	CHIPRES.	47k	1/16W	1%	RMC1/16 473FTP	J24183473		1-	B	c1
R 4021	CHIPRES.	3.3k	1/16W	1%	RMC1/16 332FTP	J24183332		1-	B	c1
R 4022	CHIPRES.	10k	1/16W	1%	RMC1/16 103FTP	J24183103		1-	B	c1
R 4023	CHIPRES.	56k	1/16W	5%	RMC1/16 563JATP	J24185563		1-	B	c2
R 4023	CHIPRES.	47k	1/16W	5%	RMC1/16 473JATP	J24185473		9-	B	c2
R 4024	CHIPRES.	4.7k	1/16W	5%	RMC1/16 472JATP	J24185472		1-	B	f3

# PANEL Unit

## Parts List

REF	DESCRIPTION	VALUE	V/W	TOL.	MFR'S DESIG	VXSTD P/N	VERS.	LOT	SIDE	LAYADR
R 4025	CHIPRES.	47k	1/16W	5%	RMC1/16 473JATP	J24185473		1-	B	b2
R 4026	CHIPRES.	47k	1/16W	5%	RMC1/16 473JATP	J24185473		1-	B	a3
R 4027	CHIPRES.	1k	1/16W	5%	RMC1/16 102JATP	J24185102		1-	B	c3
R 4028	CHIPRES.	1k	1/16W	5%	RMC1/16 102JATP	J24185102		1-	B	c3
R 4029	CHIPRES.	4.7k	1/16W	5%	RMC1/16 472JATP	J24185472		1-	B	c3
R 4030	CHIPRES.	1k	1/16W	5%	RMC1/16 102JATP	J24185102		1-	B	e2
R 4031	CHIPRES.	390	1/10W	5%	RMC1/10T 391J	J24205391		1-	B	d1
R 4032	CHIPRES.	270	1/10W	5%	RMC1/10T 271J	J24205271		1-	B	d1
R 4033	CHIPRES.	4.7k	1/16W	5%	RMC1/16 472JATP	J24185472		1-	B	d1
R 4034	CHIPRES.	390	1/10W	5%	RMC1/10T 391J	J24205391		1-	B	d1
R 4035	CHIPRES.	270	1/10W	5%	RMC1/10T 271J	J24205271		1-	B	d1
R 4036	CHIPRES.	1k	1/16W	5%	RMC1/16 102JATP	J24185102		1-	B	c3
R 4037	CHIPRES.	100k	1/16W	5%	RMC1/16 104JATP	J24185104		1-	B	c3
R 4038	CHIPRES.	4.7k	1/16W	5%	RMC1/16 472JATP	J24185472		1-	B	c1
R 4039	CHIPRES.	330	1/10W	5%	RMC1/10T 331J	J24205331		1-	B	e1
R 4040	CHIPRES.	100k	1/16W	5%	RMC1/16 104JATP	J24185104		1-	B	b1
R 4041	CHIPRES.	3.3M	1/16W	5%	RMC1/16 335JATP	J24185335		1-	B	b1
R 4043	CHIPRES.	10k	1/16W	5%	RMC1/16 103JATP	J24185103		1-	B	c3
R 4044	CHIPRES.	270	1/10W	5%	RMC1/10T 271J	J24205271		1-	B	c1
R 4045	CHIPRES.	330	1/10W	5%	RMC1/10T 331J	J24205331		1-	B	e2
R 4046	CHIPRES.	4.7k	1/16W	5%	RMC1/16 472JATP	J24185472		1-	B	b2
R 4047	CHIPRES.	4.7k	1/16W	5%	RMC1/16 472JATP	J24185472		1-	B	b2
R 4048	CHIPRES.	47k	1/16W	1%	RMC1/16 473FTP	J24183473		1-	B	e3
R 4049	CHIPRES.	82k	1/16W	5%	RMC1/16 823JATP	J24185823		1-	B	e3
R 4050	CHIPRES.	39k	1/16W	5%	RMC1/16 393JATP	J24185393		1-	B	e3
R 4051	CHIPRES.	22k	1/16W	5%	RMC1/16 223JATP	J24185223		1-	B	e3
R 4052	CHIPRES.	10k	1/16W	5%	RMC1/16 103JATP	J24185103		1-	B	f3
R 4053	CHIPRES.	560	1/10W	5%	RMC1/10T 561J	J24205561		1-	B	d1
R 4054	CHIPRES.	270	1/10W	5%	RMC1/10T 271J	J24205271		1-	B	d1
R 4055	CHIPRES.	270	1/10W	5%	RMC1/10T 271J	J24205271		1-	B	e1
R 4056	CHIPRES.	330	1/16W	5%	RMC1/16 331JATP	J24185331		1-	B	e3
R 4058	CHIPRES.	330k	1/16W	5%	RMC1/16 334JATP	J24185334		1-	B	g1
R 4059	CHIPRES.	10k	1/16W	5%	RMC1/16 103JATP	J24185103		1-	B	e2
R 4060	CHIPRES.	22k	1/16W	5%	RMC1/16 223JATP	J24185223		1-	B	e2
R 4061	CHIPRES.	39k	1/16W	5%	RMC1/16 393JATP	J24185393		1-	B	e2
R 4062	CHIPRES.	82k	1/16W	5%	RMC1/16 823JATP	J24185823		1-	B	e2
R 4063	CHIPRES.	10k	1/16W	5%	RMC1/16 103JATP	J24185103		1-	B	e2
R 4064	CHIPRES.	22k	1/16W	5%	RMC1/16 223JATP	J24185223		1-	B	e2
R 4065	CHIPRES.	39k	1/16W	5%	RMC1/16 393JATP	J24185393		1-	B	e2
R 4066	CHIPRES.	39k	1/16W	5%	RMC1/16 393JATP	J24185393		1-	B	h2
R 4067	CHIPRES.	39k	1/16W	5%	RMC1/16 393JATP	J24185393		1-	B	g2
R 4068	CHIPRES.	82k	1/16W	5%	RMC1/16 823JATP	J24185823		1-	B	e2
R 4069	CHIPRES.	39k	1/16W	5%	RMC1/16 393JATP	J24185393		1-	B	g2
R 4070	CHIPRES.	47	1/4W	5%	RMC1/4 470JATP	J24245470		1-	B	g2
R 4071	CHIPRES.	180	1/10W	5%	RMC1/10T 181J	J24205181		1-	B	h1
R 4072	CHIPRES.	0	1/4W	5%	RMC1/4 000JATP	J24245000		1-	B	h1
R 4073	CHIPRES.	100	1/10W	5%	RMC1/10T 101J	J24205101		1-	B	h1
R 4074	CHIPRES.	100	1/10W	5%	RMC1/10T 101J	J24205101		1-	B	h1
R 4075	CHIPRES.	180	1/10W	5%	RMC1/10T 181J	J24205181		1-	B	h2
R 4076	CHIPRES.	0	1/4W	5%	RMC1/4 000JATP	J24245000		1-	B	h2
R 4077	CHIPRES.	100	1/10W	5%	RMC1/10T 101J	J24205101		1-	B	h2
R 4078	CHIPRES.	100	1/10W	5%	RMC1/10T 101J	J24205101		1-	B	h2
R 4079	CHIPRES.	47	1/4W	5%	RMC1/4 470JATP	J24245470		1-	B	h1
R 4080	CHIPRES.	47	1/4W	5%	RMC1/4 470JATP	J24245470		1-	B	g2
R 4081	CHIPRES.	4.7k	1/16W	5%	RMC1/16 472JATP	J24185472		1-	B	g1
R 4086	CHIPRES.	10k	1/16W	5%	RMC1/16 103JATP	J24185103		3-	B	c3
R 4087	CHIPRES.	10k	1/16W	5%	RMC1/16 103JATP	J24185103		3-	B	c3
R 4088	CHIPRES.	4.7k	1/16W	5%	RMC1/16 472JATP	J24185472		1	B	h1
R 4088	CHIPRES.	3.3k	1/16W	5%	RMC1/16 332JATP	J24185332		2-	B	h1
R 4089	CHIPRES.	3.3k	1/16W	5%	RMC1/16 332JATP	J24185332		1-	B	g2
R 4089	CHIPRES.	5.6k	1/16W	5%	RMC1/16 562JATP	J24185562		17-	B	g2
R 4090	CHIPRES.	4.7k	1/16W	5%	RMC1/16 472JATP	J24185472		1-	B	g2
R 4092	CHIPRES.	100k	1/16W	5%	RMC1/16 104JATP	J24185104		3-	B	e3
R 4093	CHIPRES.	6.8k	1/16W	5%	RMC1/16 682JATP	J24185682		13-	B	g2
R 4094	CHIPRES.	10k	1/16W	5%	RMC1/16 103JATP	J24185103		13-	B	g2
R 4199	CARBON FILM RES.	10k	1/6W	5%	RD16PJ103 10K	J01225103		9-12		
R 4201	CARBON FILM RES.	6.8k	1/6W	5%	RD16PJ682 6.8K	J01225682		3-7		
R 4598	CARBON FILM RES.	10k	1/6W	5%	RD16PJ103 10K	J01225103		1-2		
R 4599	CARBON FILM RES.	10k	1/6W	5%	RD16PJ103 10K	J01225103		1-2		
S 4001	ROTARY ENCODER				EC12E24104A5	Q9000790		1-	A	H3
S 4002	ROTARY ENCODER				EC12E2424404	Q9000788		1-	A	H2
S 4003	TACT SWITCH				SKHUPLE010	N5090126		1-	A	C3
S 4004	TACT SWITCH				SKHUPLE010	N5090126		1-	A	G1

# PANEL Unit

## Parts List

REF	DESCRIPTION	VALUE	V/W	TOL.	MFR'S DESIG	VXSTD P/N	VERS.	LOT	SIDE	LAYADR
S 4005	TACT SWITCH				SKHUPLE010	N5090126		1-	A	G3
S 4006	TACT SWITCH				SKHUPLE010	N5090126		1-	A	A2
S 4007	TACT SWITCH				SKHUPLE010	N5090126		1-	A	B2
S 4008	TACT SWITCH				SKHUPLE010	N5090126		1-	A	F1
S 4009	TACT SWITCH				SKHUPLE010	N5090126		1-	A	F2
S 4010	TACT SWITCH				SKHUPLE010	N5090126		1-	A	C2
S 4011	TACT SWITCH				SKHUPLE010	N5090126		1-	A	G1
S 4012	TACT SWITCH				SKHUPLE010	N5090126		1-	A	G2
S 4013	TACT SWITCH				SKHUPLE010	N5090126		1-	A	C2
S 4014	TACT SWITCH				SKHUPLE010	N5090126		1-	A	D3
S 4015	TACT SWITCH				SKHUPLE010	N5090126		1-	A	G1
S 4016	TACT SWITCH				SKHUPLE010	N5090126		1-	A	H1
S 4017	ROTARY ENCODER				RES20D50-201-1G	Q9000709A		1-		
TH4001	THERMISTOR				TBPS1R472K440H5Q	G9090066		1-	B	c1
TH4002	THERMISTOR				ERTJ1V473J	G9090122		1-	B	e3
VR4001	POT.	22k			EVN-5ESX50BE4	J51811223		1-	B	c2
VR4001	POT.	50k			EVN-5ESX50B54	J51811503		9-	B	c2
X 4001	XTAL TSS-7050A	9.91MHz			9.91MHZ	H0103276		1-	B	e2



# MIC Unit (Lot. 1 ~ 3)

## Circuit Diagram

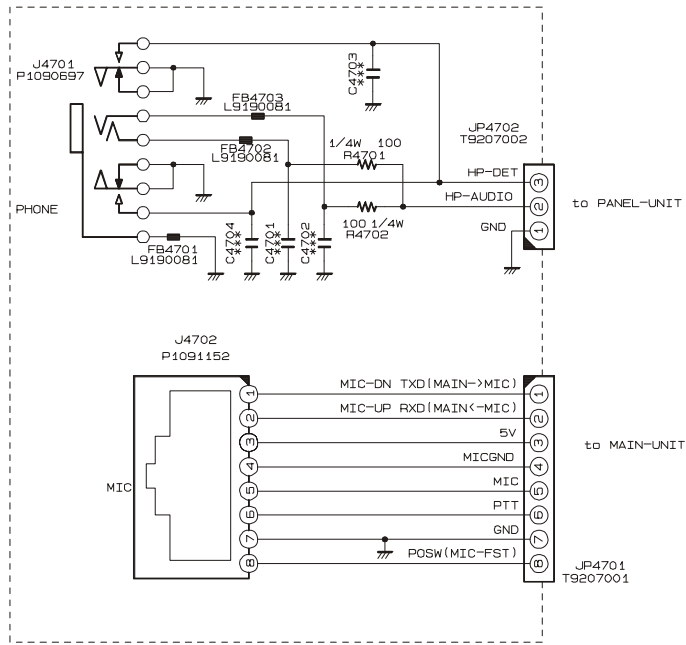

## Parts Layout

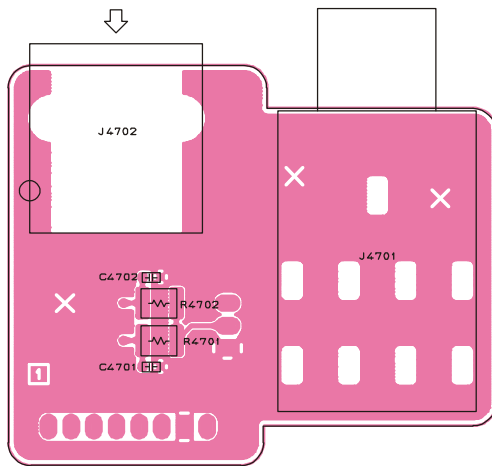

Side A

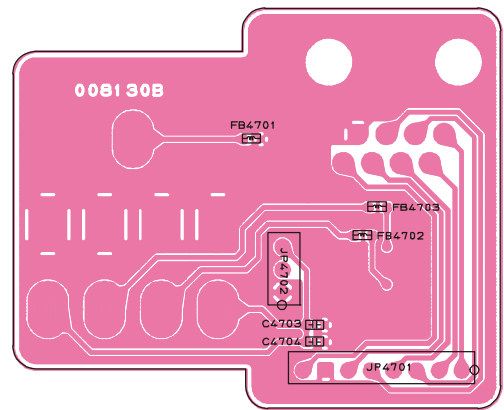

Side B

# MIC Unit (Lot. 4 ~ 13)

## Circuit Diagram

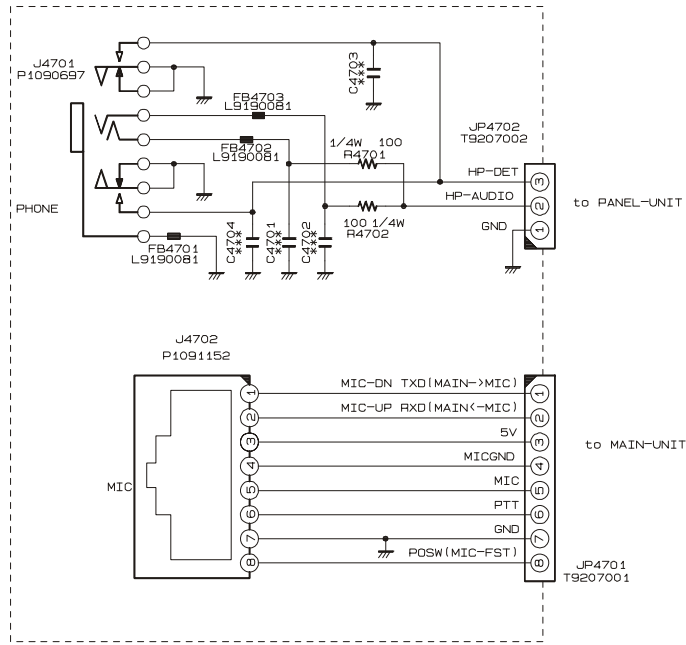

## Parts Layout

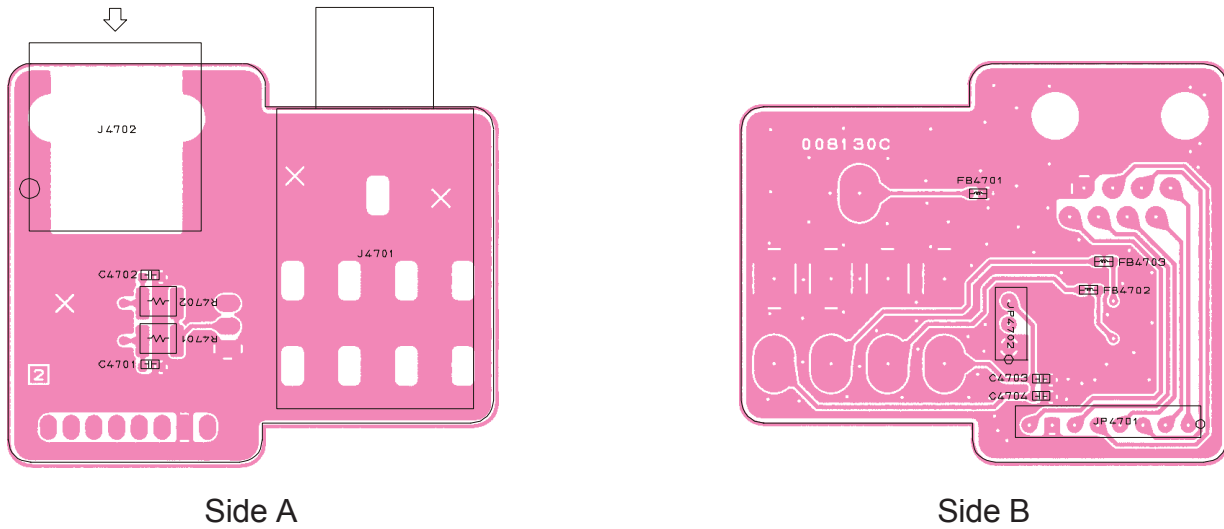

# MIC Unit (Lot. 13 ~)

## Circuit Diagram

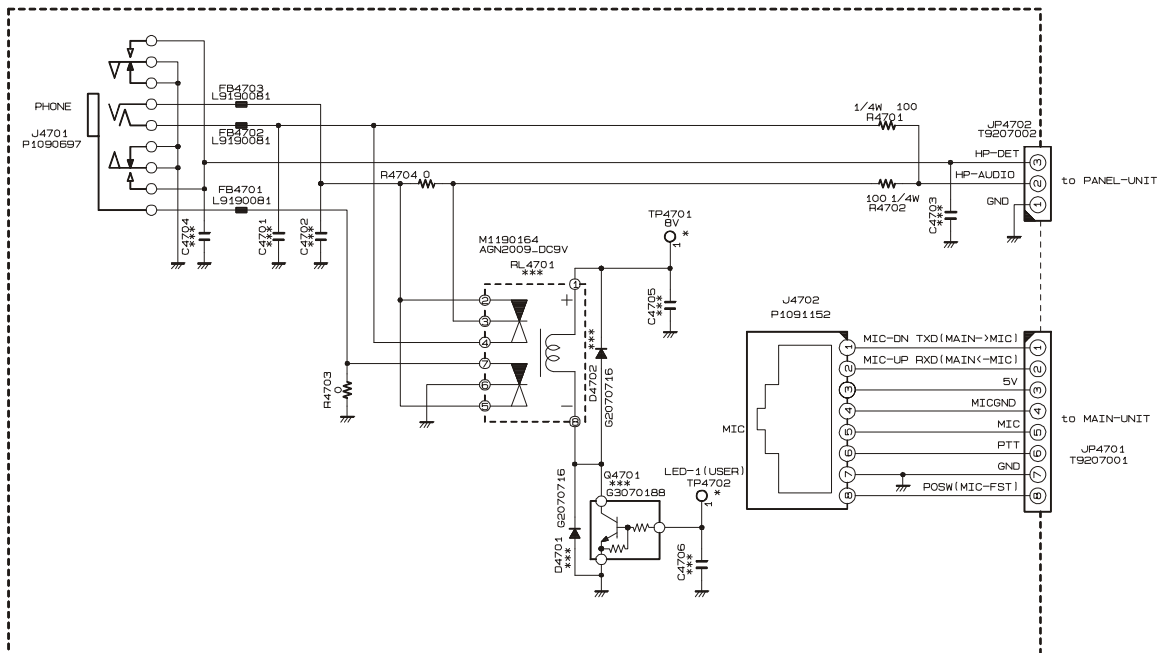

## Parts Layout

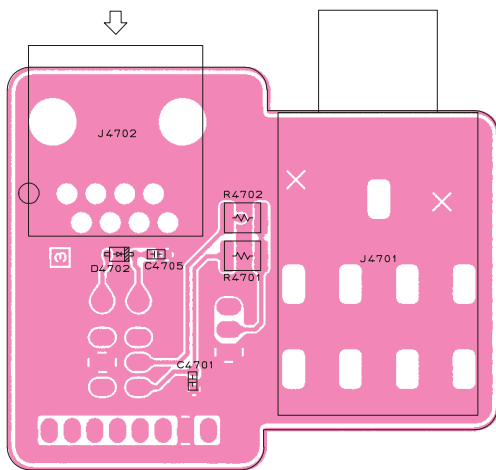

Side A

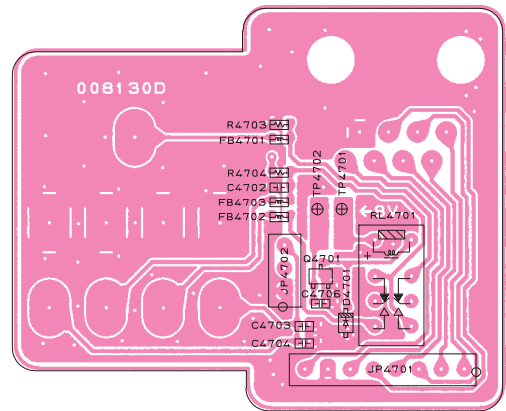

Side B

## Parts List

REF	DESCRIPTION	VALUE	V/W	TOL.	MFR'S DESIG	VXSTD P/N	VERS.	LOT	SIDE	LAY ADR
PCB with Components						CB1999001				
Printed Circuit Board						FR008130B		1-3		
						FR008130C		4-12		
						FR008130D		13-		
FB4701	FERRITE BEADS				BK1608HS121-T	L9190081		1-	B	a1
FB4702	FERRITE BEADS				BK1608HS121-T	L9190081		1-	B	a2
FB4703	FERRITE BEADS				BK1608HS121-T	L9190081		1-	B	a1
FB4790	CORE				RI-12-16-8.5	L9190092	W/ CE	4-		
J 4701	CONNECTOR				S-G4617#02	P1090697		1-	A	B1
J 4701	CONNECTOR				HLJ2305-0130609	P1090823		111-	A	B1
J 4702	CONNECTOR				HJC0282-010022	P1091152		1-	A	A1
JP4701	WIRE ASSY				AH012M #242275	T9207001		1-	B	b2
JP4702	WIRE ASSY				AH012M	T9207002A		1-	B	a2
R 4701	CHIP RES.	100	1/4W	5%	RMC1/4 101JATP	J24245101		1-	A	A1
R 4702	CHIP RES.	100	1/4W	5%	RMC1/4 101JATP	J24245101		1-	A	A1
R 4703	CHIP RES.	0	1/16W	5%	RMC1/16 000JATP	J24185000		13-	B	a1
R 4704	CHIP RES.	0	1/16W	5%	RMC1/16 000JATP	J24185000		13-	B	a1
	NYLON CLAMP				PLT-1M BK-1	S3000022	W/ CE	4-		
	SPONGE RUBBER				(C)	RA0471000	W/ CE	4-		

# VR Unit

## Circuit Diagram

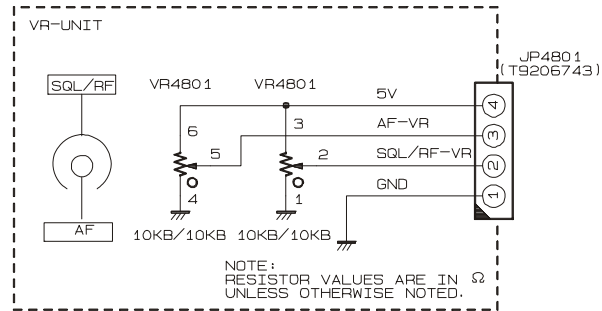

## Parts Layout

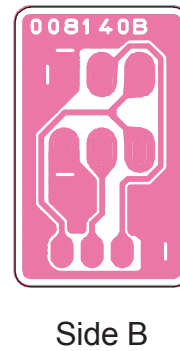
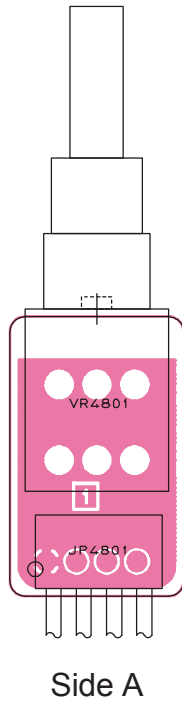

## Parts List

REF	DESCRIPTION	VALUE	V/W	TOL.	MFR'S DESIG	VXSTD P/N	VERS.	LOT	SIDE	LAY ADR
PCB with Components						CB2000001				
Printed Circuit Board						FR008140B		1-		
VR4801	POT.				RK0972210 10KB/10KB	J62800137		1-	A	

# BATT-CONN Unit

## Circuit Diagram

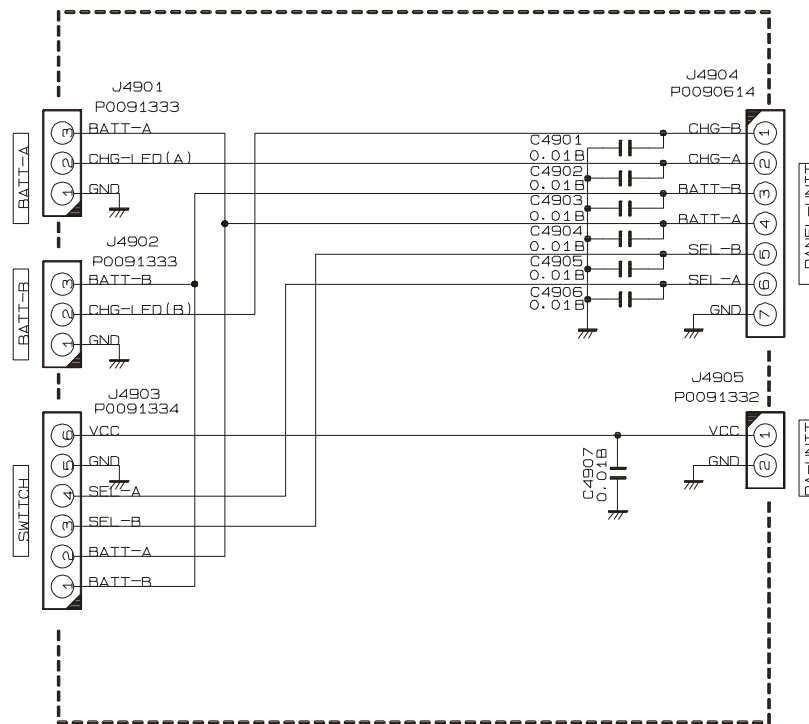

## Parts Layout

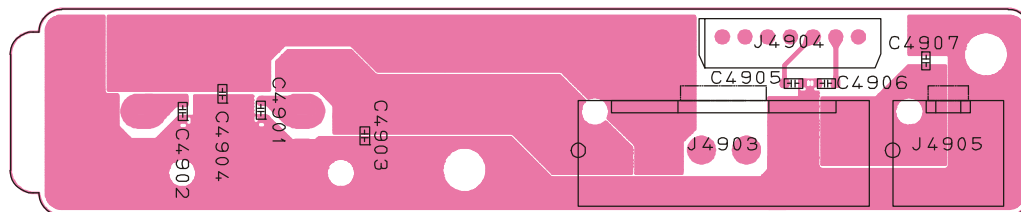

Side A

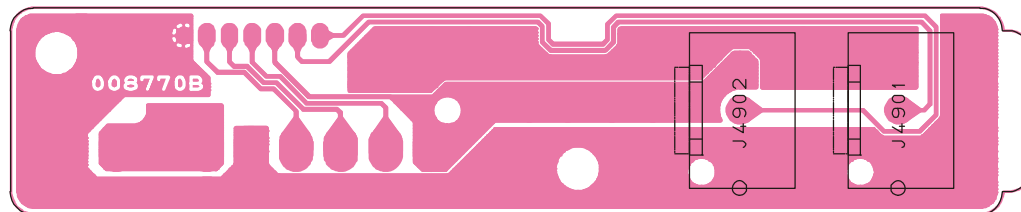

Side B

## Parts List

REF	DESCRIPTION	VALUE	V/W	TOL.	MFR'S DESIG	VXSTD P/N	VERS.	LOT	SIDE	LAY ADR
PCB with Components						CB2144001				
Printed Circuit Board						FR008770B		1-		
J4901	CONNECTOR				BH3P-VH-1	P0091333		1-	B	
J4902	CONNECTOR				BH3P-VH-1	P0091333		1-	B	
J4903	CONNECTOR				BH6P-VH-1	P0091334		1-	A	
J4904	CONNECTOR				SB20-07WS	P0090614		1-	A	
J4905	CONNECTOR				BH2P-VH-1	P0091332		1-	A	

# REF Unit (Lot.1 ~ 28)

## Circuit Diagram

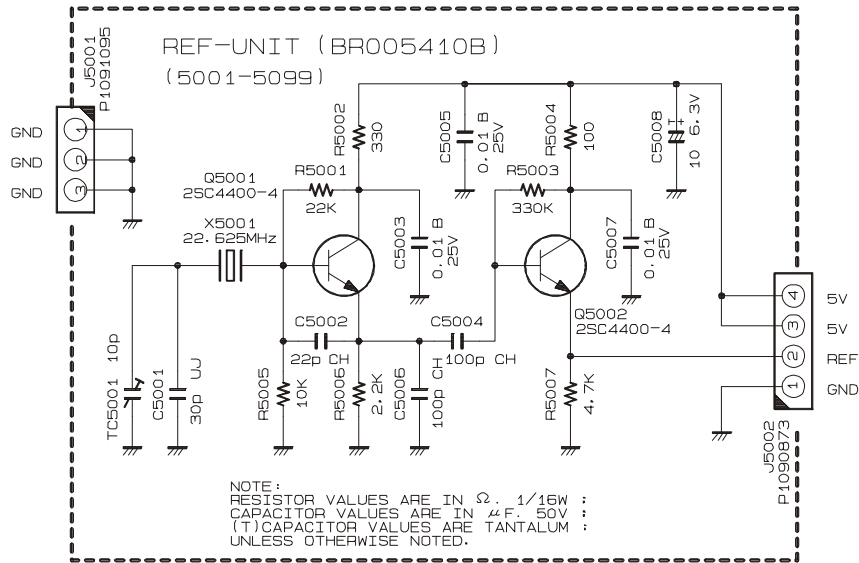

## Parts Layout

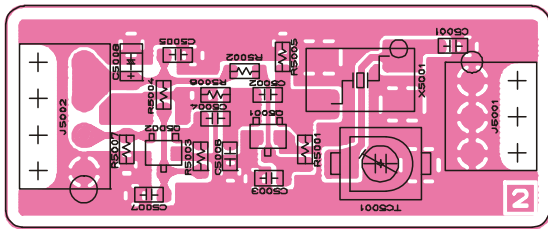

Side A

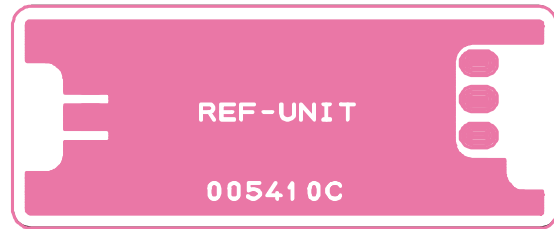
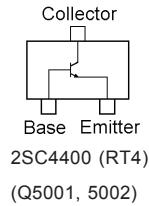

Side B

## Parts List

REF	DESCRIPTION	VALUE	V/W	TOL.	MFR'S DESIG	VXSTD P/N	VERS.	LOT	SIDE	LAY ADR
PCB with Components						CB1997001				
Printed Circuit Board						FR005410C		1-		
C 5001	CHIP CAP.	30pF	50V	UJ	GRM1883U1H300JZ01D	K22174319		1-		
C 5001	CHIP CAP.	27pF	50V	CH	GRM1882C1H270JA01D	K22174221		5-		
C 5002	CHIP CAP.	22pF	50V	CH	GRM1882C1H220JA01D	K22174219		1-		
C 5003	CHIP CAP.	0.01uF	50V	B	GRM188B11H103KA01D	K22174823		1-		
C 5004	CHIP CAP.	100pF	50V	CH	GRM1882C1H101JA01D	K22174235		1-		
C 5005	CHIP CAP.	0.01uF	50V	B	GRM188B11H103KA01D	K22174823		1-		
C 5006	CHIP CAP.	100pF	50V	CH	GRM1882C1H101JA01D	K22174235		1-		
C 5007	CHIP CAP.	0.01uF	50V	B	GRM188B11H103KA01D	K22174823		1-		
C 5008	CHIP TA.CAP.	10uF	6.3V		TESVSP0J106M-8R	K78080055		1-		
J 5001	CONNECTOR				9117S-03D	P1091095		1-		
J 5002	CONNECTOR				9117S-04D	P1090873		1-		
Q 5001	TRANSISTOR				2SC4400-4-TL	G3344008D		1-		
Q 5002	TRANSISTOR				2SC4400-4-TL	G3344008D		1-		
R 5001	CHIP RES.	22k	1/16W	5%	RMC1/16 223JATP	J24185223		1-		
R 5002	CHIP RES.	330	1/16W	5%	RMC1/16 331JATP	J24185331		1-		
R 5003	CHIP RES.	330k	1/16W	5%	RMC1/16 334JATP	J24185334		1-		
R 5004	CHIP RES.	100	1/16W	5%	RMC1/16 101JATP	J24185101		1-		
R 5005	CHIP RES.	10k	1/16W	5%	RMC1/16 103JATP	J24185103		1-		
R 5006	CHIP RES.	2.2k	1/16W	5%	RMC1/16 222JATP	J24185222		1-		
R 5007	CHIP RES.	4.7k	1/16W	5%	RMC1/16 472JATP	J24185472		1-		
TC5001	TRIMMER CAP.	10pF			ECR-JA010A11X	K91000227		1-		
TC5001	TRIMMER CAP.	20pF			ECR-JA020E11X	K91000228		5-		
X 5001	XTAL TSS-6035B	22.625MHz			22.625MHZ	H0103273		1-		

# TCXO-9 Unit (FT-897: Lot. 1 ~ 28) TCXO-9 Unit (FT-897D: Lot. 29 ~ 72)

## Circuit Diagram

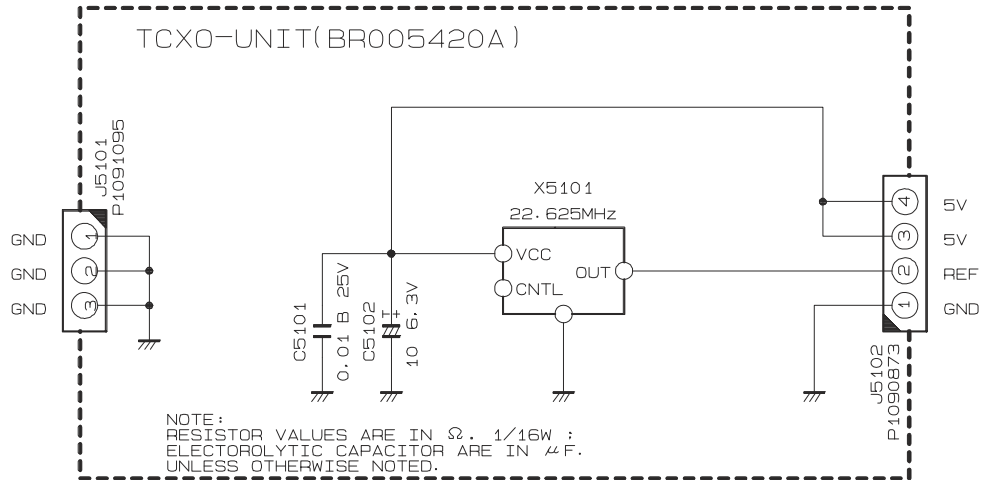

## Parts Layout

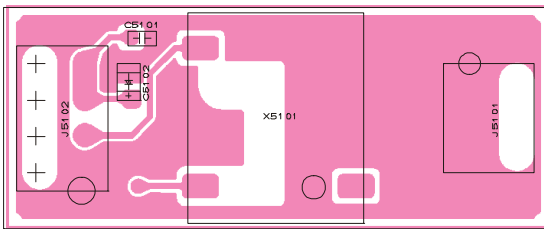

Side A

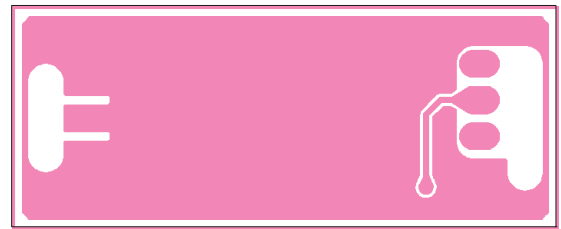

Side B

# TCXO Unit (FT-897D: Lot. 73 ~)

## Circuit Diagram

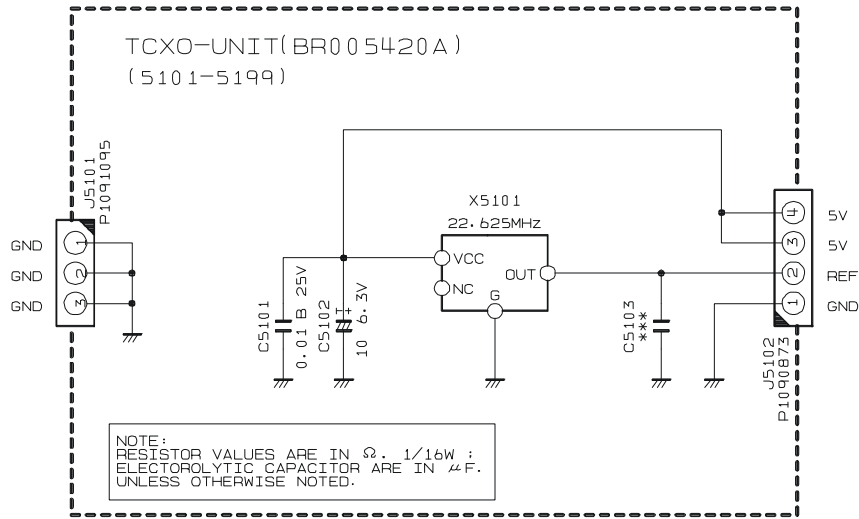

## Parts Layout

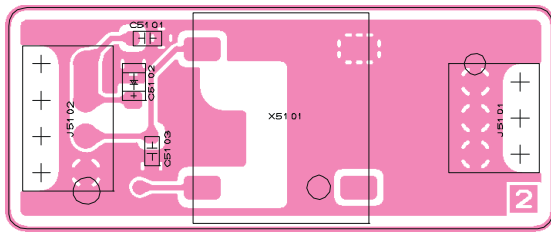

Side A



Side B

## Parts List

REF	DESCRIPTION	VALUE	V/W	TOL.	MFR'S DESIG	VXSTD P/N	VERS.	LOT	SIDE	LAY ADR
Printed Circuit Board						FR005420C		1-		
						FR005420D		73-		
C 5101	CHIP CAP.	0.01 $\mu$ F	25V	B	GRM39B103K25PT	K22144803		1-		
C 5102	CHIP TA.CAP.	10 $\mu$ F	6.3V		TESVSP0J106M-8R	K78080055		1-		
J 5101	CONNECTOR				9117S-03D	P1091095		1-		
J 5102	CONNECTOR				9117S-04D	P1090873		1-		
X 5101	TCXO	22.625MHz			NTO-801BS 22.625MHZ	H9500560		29-		
X 5101	TCXO	22.625MHz			TTS01NS-P1 22.625MHZ	H9500840		31-		







Copyright 2010  
VERTEX STANDARD CO., LTD.  
All rights reserved

No portion of this manual  
may be reproduced without  
the permission of  
VERTEX STANDARD CO., LTD.

Printed in Japan.