

YAESU

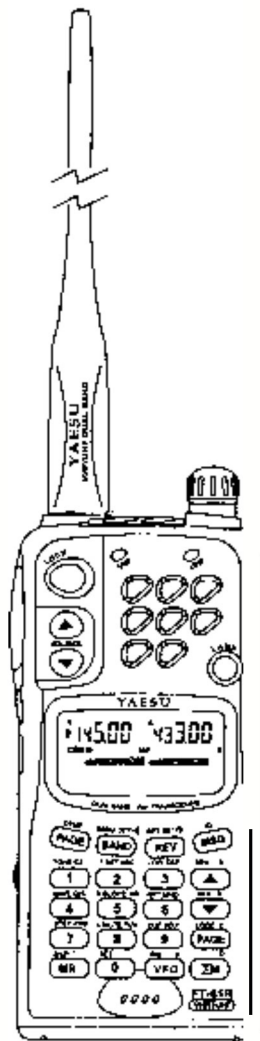

FT-51R

Dual Band FM Paging Transceiver

Contents

Specifications	3	ARS (Automatic Repeater Shift)	28
Accessories & Options List ,	4	Memory Storage	29
Controls & Connectors	5	Recalling Memories	30
Top & Front Panel	5	Call Channel Memory	31
Side Panel	7	Tuning & Masking Memories	32
LCD Indications	8	Naming Memories	33
Accessories	9	Scanning	34
Batteries & Chargers	9	Memory Skip Scanning & PMS Scanning	35
Battery Removal & Replacement	11	Priority Channel Monitoring	36-37
Key Functions	13-14	CTCSS Operation	39
Operation	15	ATS (Auto Tone Search) Operation	40
Preliminary Steps	15	CTCSS "Bell" Operation	42
Volume & Squelch Setting	17	DTMF Paging & Code Squelch	43
Frequency Selection Modes	18	Sending Messages	50
User Help Messages	19	Customizing Ringer Settings	56
Frequency & Step Selection	20	DTMF Autodial Memories	57
Tuning & Dual In-Band Receive	21	Naming Autodial Memories	58
Spectrum Scope Operation	22	Set Mode Customization Table	63
Transmitting	23	Appendix	65
Duplex Operation	24	Extending Battery Life	65
Sub-channel Receiver Mute	26	Cross-Band Repeater Settings	69
Repeater Splits	26	Transceiver Cloning	71
Setting Standard Repeater Offset	27	Packet Radio Connections	72
		In Case of Problems	73

FT-51R Dual-Band FM Hand-Held Paging Transceiver

Congratulations on the purchase of your Yaesu amateur transceiver! Whether this is your first rig, or if Yaesu equipment is already the backbone of your station, rest assured that your transceiver will provide many hours of operating pleasure for years to come. Along with the philosophy that each Yaesu transceiver should serve you well into the future, Yaesu stands behind our products with a worldwide network of dealers and service centers. Feel free to contact us if you ever need technical advice or assistance. The FT-51R is a deluxe compact FM hand-held transceiver for both 2-m and 70-cm amateur band operation. A few of the new features in this dual-band rig include the following:

- **Spectrum Scope** – allows viewing station activity above and below a selected channel: simply turn the dial to center a signal of interest on the scope and press the PTT to operate!
- **Pre-programmed User-Help messages** – guide you through most operational function selections and settings - even informing you which battery pack type is installed!

- **DTMF and Message Paging with Morse Code Annunciator** – decodes incoming DTMF Paging codes and messages with CW play-back!
- **Improved cross-band and full-duplex operation** with "Duplex" mode and auto sub-receiver muting. This along with cellular-style body design allows enhanced telephone-style cross-band full-duplex operation – great for use with personal telephone autopatch units.
- **Five selectable tx power levels**, with an *economy-low* level (20 mW) for maximum battery life during short range communications.

A single knob and push-buttons for volume and squelch control simplify handling and operation. The upper display shows operating frequency and most programmable functions. Relative signal strength, power output and preset volume & squelch level appear on the multi-function bargraph meters. The lower display scrolls User-Help and DTMF paging messages, and also double as a Spectrum Scope display for viewing channel activity. The display and translucent keypad have selectable lighting modes.

Twin VFOs and 40 programmable memories (including an instant-recall Call channel) are available on each band. Memories can be tagged with an 8-character alphanumeric name and this name can be displayed instead of the frequency (the naming feature can be turned off to expand memory capacity to 60 per band, if desired).

Searching for station activity has never been easier with VFO, memory and programmed-limit (sub-band) scanning and the new spectrum scope feature. Select all or only those memories you want to be scanned. When activity is found, scanning can be set to halt, resume after 5-seconds, or resume when the station stops transmitting. One memory on each band can also be enabled for priority monitoring. The built-in CTCSS (Continuous Tone-Coded Squelch System) provides 39 subaudible tones which can be stored in each memory independently. The CTCSS Bell feature can be set to ring when the tone squelch opens.

A wealth of selective DTMF calling and private paging features allows for quiet monitoring until calls directed to you (or only stations in groups you select) are received. In addition, DTMF messages up to twelve characters long can be sent to other stations. Received messages

are displayed and automatically stored for later retrieval. A tri-mode ringer alerts you to calls or messages by sounding a preset or user-programmed melody, or else have the built-in CW decoder announce the message in Morse code! The FT-51R can even respond to or relay (forward) paging calls when you are absent. For autopatch operation, a 10-memory, 15-digit DTMF autodialer stores frequently-called numbers for playback. The DTMF autodial memories can also be tagged with alpha-numeric names.

Full power output is available with only a 9.6-volt battery, and a wide range of features ensure maximum operating time: The ABS (Automatic Battery Saver) monitors operating history and optimizes save duration accordingly; Tx Save automatically reduces transmit power during periods of high receive signal strength; selectable-period APO (Automatic Power Off) timer turns off the radio after a period of inactivity; and selectable continuous or 5-second LCD and keypad illumination.

Although you are probably anxious to begin operating the FT-51R, please take some time to carefully review this manual thoroughly and familiarize yourself with the FT-51R.

Specifications

General

Frequency range: (Rx) 110–180 MHz 420–470 MHz
(Tx) 144–148 MHz 430–450 MHz

Channel steps: 5, 10, 12.5, 15, 20, 25 & 50 kHz

Repeater shift: ± 600 kHz, ± 5 MHz (programmable)

Emission type: F3, F2

Supply voltage: 4.0 – 12-VDC

Current Consumption:

	VHF	UHF
Auto Power Off:	200 μ A	200 μ A
Stby (Saver on):	16.9 mA	16.3 mA (17.3 mA dual-rx)
Stby (Saver off):	52 mA	49 mA (85 mA dual-rx)
Rx	195 mA	195 mA
Tx (5W@9.6VDC):	<1.6 A	<1.9 A

Antenna (BNC jack): YHA-55 rubber flexible

Case size (WHD): 57 x 123 x 26.5 mm w/FNB-31

Weight (approx.): 330 grams with FNB-31 & antenna

Receiver

Circuit type: Double-conversion superheterodyne

IFs: 45.05 MHz & 455 kHz (VHF)
58.525 MHz & 455 kHz (UHF)

12-dBSINAD Sensitivity: < 0.158 μ V (VHF)
< 0.180 μ V (UHF)

Adjacent channel selectivity: > 65 dB VHF
> 60 dB UHF

Intermodulation: > 65 dB (VHF), > 60 dB (UHF)

AF output: 0.2 W @ 8 Ω for 10% THD

Transmitter

RF output: See the chart below, and on page 24.

Battery Type	VHF Output	UHF Output
FBA-14 Dry Cell Case (4 x "AA cells)	2.0 W	1.5 W
FNB-31 (4.8V, 600 mAh)	2.0 W	1.5 W
FNB-33 (4.8V, 1200 mAh)	2.0 W	1.5 W
FNB-35 (7.2V, 900 mAh)	4.0 W	3.5 W
FNB-38 (9.6V, 600 mAh)	5.0 W	5.0 W

Frequency stability: Better than ± 5 ppm

Modulation system: Variable reactance

Maximum deviation: ± 5 kHz

FM Noise (@ 1 kHz): Better than 40 dB @ 1 kHz

Spurious emissions: > 60 dB below carrier

AF distortion (@ 1 kHz): < 5%, w/3.5 kHz deviation

Microphone type: 2-k Ω condenser

Specifications subject to change without notice or obligation.

Accessories & Options List

Rechargeable Ni-Cd Battery Packs

FNB-31	4.8 V, 600mAh
FNB-33	4.8 V, 1200mAh
FNB-35	7.2 V, 900mAh
FNB-38	9.6 V, 600mAh

Dual-Slot Rapid Charger

NC-50	for FNB-31, -33, -35 & -38
CA-10	Charger Sleeve (used w/NC-50)

Compact 15-Hour Chargers

NC-55B/C*	for FNB-31 (use w/CA-9)
NC-34B/C	for FNB-33/35 (use w/CA-9)
NC-38B/C	for FNB-38 (use w/CA-9)

* "B" suffix for use with 117VAC, or "C" for use with 220-234 VAC.

CA-9	Base Charging Stand (used w/NC-34B/C, -38B/C and -55B/C)
------	---

Other Accessories

FBA-14	Battery Case for 4 AA-size Dry-Cells
CSC-66	Soft Case for FBA-14, FNB-33, -35, -38
CSC-67	Soft Case for FNB-31
PA-10A	Mobile Power/Adapter (w/o fan)
CD-2	Mobile Rapid Charger
MH-12 _{A2B}	Hand Speaker/Microphone
MH-19 _{A2B}	Earpiece/In-Line Miniature Mic
MH-29 _{A2B}	Remote Control Microphone
MH-32 _{A2B}	Speaker/Microphone
MH-35 _{A2B}	Speaker/Microphone
vc-22	VOX Headset

Availability of accessories may vary: some accessories are supplied as standard per local requirements, others may be unavailable in some regions. Check with your Yaesu dealer for changes to the above list.

Controls & Connectors

Top & Front Panel

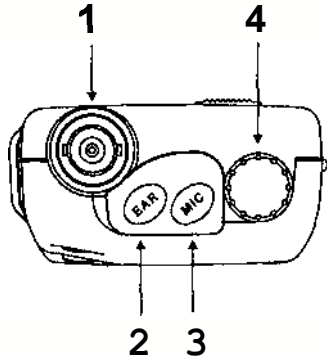

(1) Antenna Jack

This BNC jack accepts the supplied YHA-55 flexible antenna, or another antenna designed to provide 50- Ω impedance on 2-m & 70-cm.

(2) EAR Jack



This 2-conductor, 3.5-mm mini phone jack provides audio output for an optional ear-phone or speaker/mic (impedance is 8 Ω). The internal loudspeaker is disabled when this jack is used. Note: *the protective rubber cover over the jacks must be pulled up to access them. Press it back over the jacks when they are not in*

use, to protect the inside of the transceiver from dust and water.

(3) MIC Jack

This 2-conductor, 2.5-mm phone jack accepts an optional microphone or speaker/mic (impedance is 2 k Ω). The internal microphone is disabled while this jack is used.

(4) DIAL Rotary Selector

Rotate this to tune, or select memories and other settings, according to the function selected by the keys. This knob can be set to duplicate some functions of the / keys for convenience (page 60).

(5) LOCK button

This button locks the front-panel controls and buttons. Four locking modes are selectable: keypad, PTT, **DIAL** and volume level, in various combinations.

(6) / buttons

These adjust the volume of the receiver in 16 increments, indicated on the bargraph meter for each band. Also, the squelch is adjusted in the same manner after first pressing . This

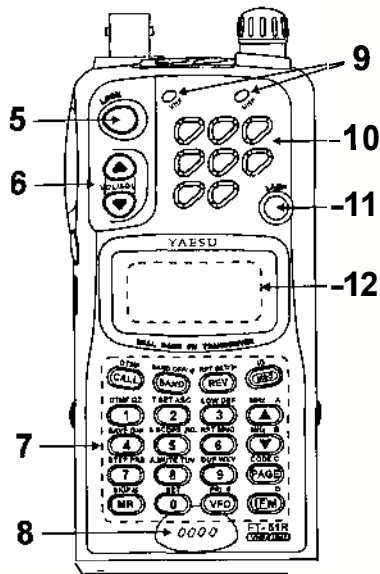

sets the threshold at which received signals (or noise) open the squelch. It should normally be set just to the point where noise is silenced (**VHF** or **UHF** lamp is off) when the channel is clear.

(7) Front Panel Keys

These keys generate DTMF tone pairs during transmission (except **CALL**), **BAND**, **REV** & **MSD**), and select operating features during reception. One or two beeps sound whenever a key is pressed (unless the keypad beeper is dis-

abled). The labels on the keyfaces indicate their primary functions, while labels on the panel indicate alternate functions, which are activated by momentarily pressing **GM** first, and then the desired key within five seconds.

There are also some "Setting Mode" functions, for customizing less-commonly used features. This mode is activated by pressing and holding **GM** → **SET** then using the **DIAL** and **MHz A** / **MHz B** keys to select and change function settings. See pages 13, 14 and also the *FT-51R Operator's Quick Code Sheet* for a list of key functions (these are described in detail later).

(8) Microphone

Speak across this opening in a normal tone of voice while pressing the PTT.

(9) VHF & UHF (Busy/Tx) Indicator Lamps

These LED indicators glow red when transmitting, and green when the noise squelch is open (the channel busy) during reception.

(10) Loudspeaker

Use the **VOL/SQ** buttons to adjust the speaker audio level on an active station or on channel noise (by first opening the squelch).

(11) LAMP Switch

Press to illuminate the display and keypad for 5 seconds when operating in the dark. Press **(EM)** first if you want the lamp to stay on (until you press the switch again).

(12) LCD (Liquid Crystal Display)

See the graphic on the next page for descriptions of the display icons and indications.

Side Panel

(13) PTT Switch

The two buttons under the rubber cover are activated by pressing the ridges at the center (PTT – Push-to-Talk) or bottom (Squelch override/Monitor or Burst) of the cover.

The rubber cover over the switches is intended to be permanent, and allows the switches underneath to be operated without removal.

Press and hold the **PTT** switch while speaking across the microphone opening to transmit (the microphone element is at the panel bottom). While transmitting, the VHF or **UHF** indicator glows red, and pressing the front panel keys transmits a DTMF tone or tone sequence.

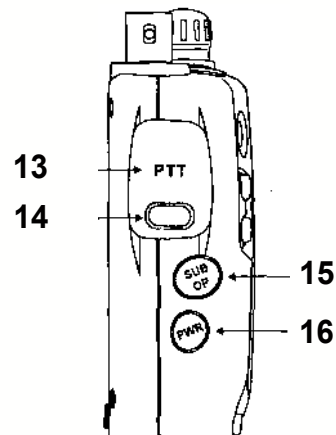

(14) Monitor Switch

This opens the squelch momentarily without disturbing the squelch settings. Pressing **(EM)** beforehand causes receiver audio to be muted (**MUTE** displayed) until the button is released. In European versions, this button transmits a 1750-Hz tone, for repeater access.

(15) Sub Operation Button

Press this to toggle operation from the main channel to the sub channel.

(16) POWER switch

To turn the transceiver on, gently press this orange switch momentarily. Press *and hold* for ½ sec. to turn the power off.

LCD Indications

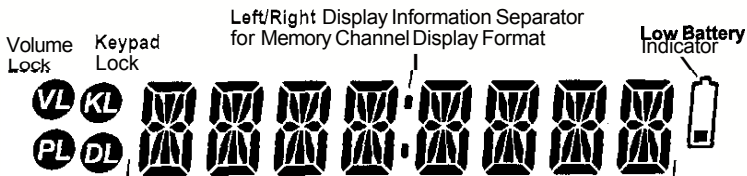
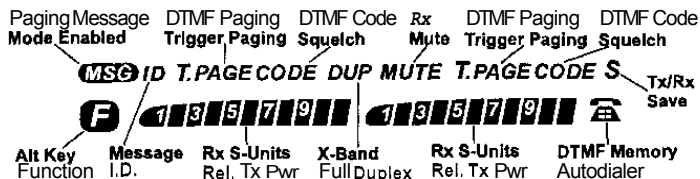
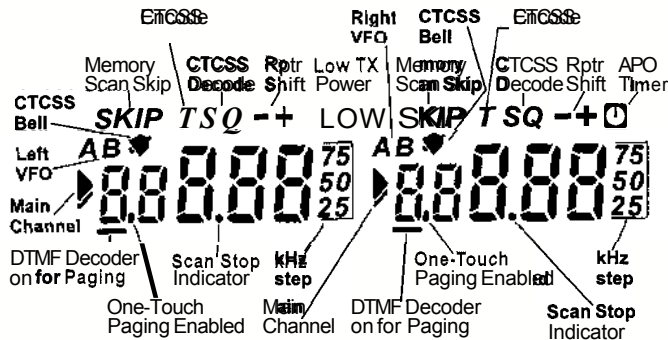

Spectrum Scope Mode: Center Channel and Adjacent Channel Signal Activity (single or "stacked" zeros indicate signal strength).

Message Paging Mode: Scrolls DTMF Alphanumeric Message from Paging Station.

User Help Function: Scrolls User Help Messages to aid in Programming and Operation.

Accessories

Batteries & Chargers

The FT-51R requires the FNB-38 9.6-volt rechargeable Ni-Cd battery pack for the full 5-watt transmitter power output. However, where slightly lower maximum power output is practical, the 7.2-volt FNB-35 (providing 4 watts) and the 4.8-volt FNB-31 and FNB-33 Ni-Cd packs (1.5 watts) offer smaller size, lighter weight or extended battery charge life.

Also, when using the PA-10A Mobile Power Adapter, the Ni-Cd packs may be recharged whenever the radio is inserted into the adapter. Any Ni-Cd pack should be fully charged before it is used with the transceiver for the first time.

Three types of battery chargers are available: 15-hour CA-9 Charging Stands, the NC-50 Dual-Slot Rapid Charger (used with CA-10 Charger Sleeves) and the internal charging circuit provided by the PA-10A Mobile Power Adapter and an external DC voltage source.

Different 15-hour compact chargers are required for different packs (see table):

Ni-Cd Pack	Voltage (DC)	Capacity (mAh)	Compact Charger
FNB-31/33	4.8	600/1200	NC-55B/C
FNB-35	7.2	900	NC-34B/C
FNB-38	9.6	600	NC-38B/C

Ensure you use the correct charger for each pack. Each compact charger is available with a "B" suffix for operation from 117-V AC, or with a "C" suffix for operation from 220 - 234-V AC.

NC-50 Dual-Slot Rapid Charger

The NC-50 is a universal AC mains battery charger with rapid and trickle charging modes, and comes wired for the mains voltage in the area sold. Up to two CA-10 Charger Sleeve units fit into the base of the NC-50, allowing different Yaesu Ni-Cd pack series to be charged.

The rapid mode initially brings the battery pack to full charge as fast as safely possible using a A-V sensor. A red LED lights during quick charging, and when the pack approaches full charge, the charger reverts to trickle mode (green LED), to prevent self-discharge. The rapid mode recharges a battery in about 1 hour.

PA-10A Mobile Power Adapter

The PA-10A charger/power adapter provides operating and battery charging voltage from an automobile electrical system or other DC source. Designed for the car door or dashboard, it allows convenient and safe mobile operation. Dual flexible latching arms facilitate easy insertion and removal of the FT-51R, while providing a secure transceiver mount for battery charging and operation in a mobile environment. *Use only with 12-volt negative-ground electrical systems.*

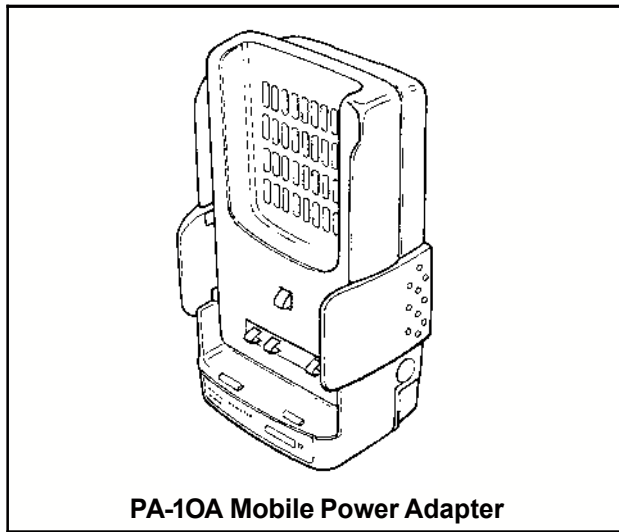

PA-10A Mobile Power Adapter

The PA-10A provides regulated 11-VDC output for operating the transceiver and for trickle-charging NiCd batteries when the transceiver is not in use. When the transceiver is inserted into the hanger, an LED turns on to indicate charging is taking place, and the transceiver display automatically illuminates for easy night-time viewing (unless the feature is disabled).

FBA-14 Dry-Cell Battery Case

The FBA-14 dry-cell battery case may be used with four "AA"-size (UM-3) batteries. Maximum power output is about 1.5 watts. Use alkaline cells for best performance.

Caution! *The FBA-14 must not be used with rechargeable cells.* It lacks the necessary thermal and over-current protection circuits provided in the FNB series Ni-Cd Packs.

One or more of the above battery packs/cases may be supplied with the transceiver. If you need a battery, contact your Yaesu dealer. We do not recommend the use of any other type of battery with the FT-51R, and using another type may affect your warranty.

Battery Removal & Replacement

- ❑ Make sure the power is switched off, and remove the protective soft case, if used. Grasp the transceiver horizontally with your left hand, so your thumb is on the Battery Release slide button.
- ❑ Move the button in the direction shown by the arrow, while using your right hand to slide the battery case up slightly and outward away from the transceiver battery well. The battery should slide smoothly out of its track.

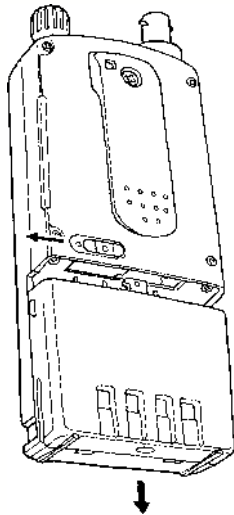

To open the FBA-14 battery case, place your thumbs on the lugs on top of the case and gently pry the case apart. Replace all four batteries, noting the polarity indicated inside the case.

✘ *Do not attempt to open any of the rechargeable Ni-Cd packs, and do not install rechargeable cells in the FBA-14, as they could explode if accidentally short-circuited.*

To replace the battery case or Ni-Cd pack, repeat the steps above, inserting the battery case in the other direction after aligning the four locking lugs of the battery case with the guide channels in the transceiver battery-well sides.

Notice

When battery voltage approaches the level where recharging or pack changeout is necessary, the  icon blinks. We recommend replacing the battery or inserting the transceiver into its charger at this time.

If the battery voltage drops further, the display blinks and the transceiver PWR switch no longer functions (transceiver cannot be switched off). Recharge or replace the pack immediately.

MH-12A2B MH-32A2B & MH-35A2B Speaker/Microphones

A Speaker/Mic can increase operating convenience and extend communications range. Each is equipped with a dual plug connector which mates with the **EAR** and **MIC** jacks on the top panel of the transceiver, disabling the internal speaker and microphone. The cable lets you clip the transceiver to your belt, or hold it above obstructions for better performance. Also, using a Speaker/Mic for mobile operation allows the transceiver to be left in the PA-10A Mobile Power Adapter/Mount.

Hold the Speaker/Mic near your ear during reception; or connect an earphone to the plug on the Speaker/Mic, attenuating the audio from its loudspeaker. To transmit just hold the Speaker/Mic near your mouth and close the PTT switch on the microphone.

MH-29A2B Remote Control Micro- phone

The MH-29A2B is a scanning hand loudspeaker/microphone with programmable function key and its own display. A lamp switch

turns on backlight illumination for easy viewing in the dark. Transceiver volume level can also be adjusted by holding the **CALL** key on the MH-29A2B then pressing the **UP/DWN** buttons.





















VC-22 VOX Headset with Boom Microphone

The VC-22 connects to the **EAR** and **MIC** jacks in the same manner as the speaker/mics. It consists of a headband-supported earphone and attached boom microphone, allowing hands-free VOX operation with the transceiver.











Antenna Considerations

While the supplied rubber flex antenna is convenient for short-range operation, the standard BNC jack allows use of a higher gain antenna to extend range in base or mobile operation. Any antenna used with the FT-51R should have an impedance close to 50 ohms on the 2-m & 70-cm amateur bands. If a feedline is used, it should be good quality 50-Ω coax. Obtaining a proper fit with some BNC plugs may require removing the rubber gasket around the antenna jack on the transceiver.

FT-51R Key Functions

Key	Normal Function	Alt Function (after pressing ) –  icon displayed for 5 secs.
	Enter digit 1	Toggles CTCSS Encode/Decode Mode: T / TSQ / off.
	Enter digit 2	Toggle display of CTCSS tone frequency (use the DIAL knob or the  /  keys to select a desired tone).
	Enter digit 3	Toggle High or 4-step selectable low Tx power. Select the Low Tx power level setting using the DIAL knob or  /  keys (L1 , L2 or L3).
	Enter digit 4	Display and select the power saver interval (sleep ratio): use the DIAL knob or  /  keys to select the desired ratio, automatic or off.
	Enter digit 5	Enable/disable receiver spectrum display scope.
	Enter digit 6	Toggles repeater shift direction: - / + / off (simplex).
	Enter digit 7	Display/select tuning steps size (use DIAL to select default steps of 5, 10, 12.5, 15, 20, 25 & 50 kHz).
	Enter digit 8	Toggle the sub-receiver audio mute feature on or off.
	Enter digit 9	Selects the Duplex mode (for normal or reduced audio on transmit).
	Enter digit 0	Activate "set-function" mode:  displayed for 5 secs., rotate the DIAL knob to select any of 26 functions, and use the  /  keys to change default settings.

Key Functions (continued)

Key	Normal Function	Alternate Function (after pressing (OM)) – Q icon displayed for 5 secs.
	From VFO: recall last-used memory channel. From Memory: enable memory tuning – M appears at display bottom.	From memory mode only: toggle scan skip of currently selected memory channel.
	Enable alternate function of following key pressed within 5 seconds (" Q " displayed).	Cancel alternate function (while " Q " is still displayed.).
	From VFO: select VFO "A" or "B". From Memory: select last-used VFO.	Activate Priority monitoring, PRI appears at display bottom.
	Jump to CALL channel, CALL appears at display bottom.	Toggle DTMF autodial memory mode (" Q " displayed).
	Toggle Main Channel display (left/right).	Turn off the Sub Channel display.
	Toggle repeater shift (reverse input/output frequencies).	Display/change default repeater shift (offset). Change with DIAL or  buttons.
	Enables DTMF Message programming.	Activates the Message receive system.
	Tune up/down a step or memory, press and hold to start scanning (band or channel).	Tune up/down in 1 MHz steps.
	Display/select preset volume level.	Display/select preset squelch level.
	Toggle Paging/Trigger Paging/Code Squelch and CTCSS Bell Functions.	Display/select DTMF Code memories.

Note: a description of Set-Mode Functions and their customization is provided on page 63,

Operation

This chapter describes the various transceiver functions tutorially. After studying these descriptions, keep the *FT-51R Operator's Quick Code Sheet* handy to refresh your memory.

Preliminary Steps

Before operating the FT-51R the first time:

- Charge the battery pack completely (if using Ni-Cd batteries) as described on page 11. If using an FBA-14 dry-cell battery case, install the batteries (also described on page 11).
- Connect the supplied antenna to the antenna jack on the top of the transceiver. *Never operate the transceiver without an antenna connected.*
- If you have a Speaker/Mic, we suggest you not connect it until you are familiar with basic operation.
- Before proceeding, please read the *Controls & Connectors* chapter, if you have not already, to familiarize yourself with the functions of the controls. Note especially the display on page 8, and key information on pages 13, 14 & 63.

When you press the front panel keys during reception, one or two beeps sound to indicate key contact. Don't hold the  key down unless you are storing a memory, and try to avoid pressing two keys at the same time. While transmitting, the keys generate DTMF tones according to their numeric label or the blue **A**, **B**, **C**, **D**, *****, **#** label (near the non-numeric keys).

You need not be too concerned about the following descriptions of timers - they are much easier to understand (by doing, which we will get to shortly) than to describe.

Low Battery-Power Indicator

When the battery voltage is low, the indicator appears, indicating the battery pack should be recharged or batteries replaced. If the battery voltage drops further,  blinks; if you continue operating, the transceiver eventually turns itself off.

We recommend immediately replacing the pack at first indication of low voltage.

Keypad Beeper

You can turn the keypad beeper on and off press **GM** → **SET** (0), then rotate the DIAL until **SET 3KEY BEEP** appears. Use **MHz A** (▲) or **MHz B** (▼) to toggle the beeper on/off. If you lock the keypad (as described on page 37) with the beeper enabled, each key sounds a different tone for as long as it is held. Press the PTT or **SET** (0) to return to the display to normal.

A several-second timer starts when you press **GM**, and automatically restarts when you turn the DIAL knob or press **MHz A** (▲) or **MHz B** (▼). Pressing other keys may shut off the timer as the resulting change in operation occurs, or restart the timer so you can select various functions.

The beeper provides useful audible feedback whenever a key is pressed. Each key has a different pitch, and many functions have unique beep combinations. For example, you will hear a low-pitched beep followed by a high-pitched beep when you press **MHz A** (▲), or a high-pitched beep followed by a low-pitched beep when you press **MHz B** (▼). You can disable the beeper as described in

the box, but we recommend keeping it enabled while getting to know the key functions.

With that said, if you experience any difficulties getting the transceiver to work as described in the manual, see the chapter *In Case of Problems*, starting on page 73.

Important Terms

If the transceiver has not been used before, the display will look something like this:

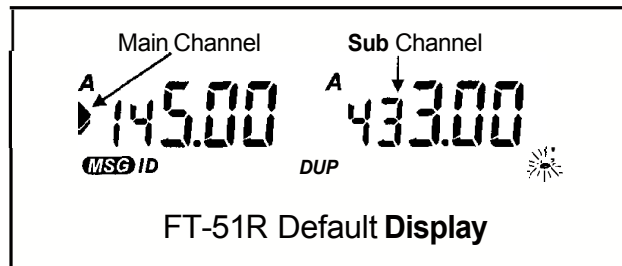

We call the frequency to the right of the **A** icon the *main* channel, and the other frequency (if displayed), the *sub* channel (these can be on either side of the display). You can select the desired main channel by pressing **BAND OFF** (BAND) to toggle **A** back and forth. You can also turn the sub channel frequency display on and off by pressing **GM** → **BAND OFF** (BAND).

Dual receive is active only when a sub channel is displayed; the **BAND OFF** button selects which band or bands appear in the main and sub channel displays. Transmission is only possible on the main channel, but both receivers can be set to frequencies in the same band in any combination (V&V, V&U, U&U, U&V). Along with separate preset volume and squelch levels and VHF & UHF tx/rx LEDs, each channel has its own memory display, and bargraph meter for signal strength and power output (S/PO) indication.

Normally, the **DIAL** selector knob and keypad functions only affect the main channel. However, by pressing **@** first so that **)** blinks next to the sub channel, the controls now acts on the sub channel instead. After making adjustments to the sub channel, press **SUP** again to return control to the main channel.

Volume Setting

Press **BAND OFF** to select the desired band, then press **VOL** or **VOL/SCL** to adjust receiver volume for that band. While setting the volume, **VOL** is displayed followed by a **Zone** segment on the LCD bargraph to provide a visual reference of the selected level.

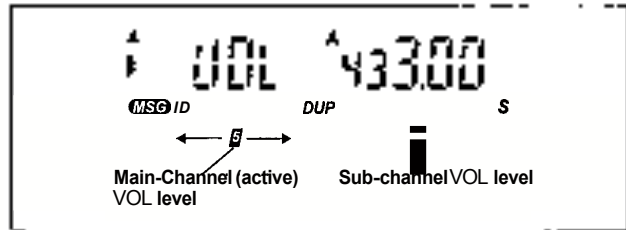



Each press of the button adjusts the volume level one increment, and two increments move the bargraph segment one place. If there is no signal, you can temporarily override the squelch by holding the center **MONI** button (below the PTT switch, while adjusting the volume on background noise.

Squelch Setting

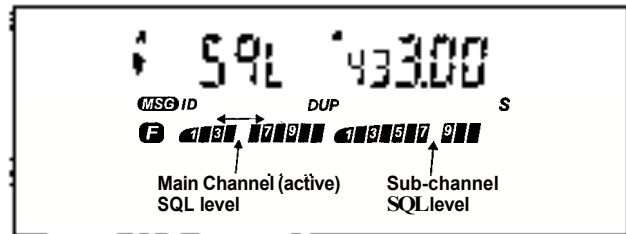
Squelch silences background noise when no signal is present on the channel. You adjust the receiver squelch for each band in a similar manner as the volume using the **@** & buttons, after first pressing **GM** (within 3 seconds).



While setting the squelch, **59L** appears followed by a *blanked* segment (inverse of the volume setting display) on the S/PO bargraph meter, indicating the present squelch level. Below the third segment (approx.), the VHF or UHF LED glows green, indicating the squelch is open. To set the squelch:

- After setting the volume to a comfortable level, if a signal is present, turn the DIAL to an empty channel (no signal, or **only** noise).
- Press **[GM]** and then  or  just to the point where background noise is silenced and the LED turns off. (If the squelch is set to a higher level, sensitivity to weak signals is reduced.)

Now, whenever a signal is received strong enough to open the squelch, the VHF or UHF indicator for the appropriate band glows green.

Note that while receiving, one or more bargraph segments may appear along the bottom of the display, indicating received signal strength. This is not affected by the squelch, so even squelched signals can give some indication. If several bargraph segments appear while the squelch is closed, try reducing the squelch setting (if you want to hear weak signals).

In non-European versions, the monitor switch (the button below the PTT) opens the squelch so you can check for weak signals, and adjust volume independently.



Frequency Selection Modes

VFO Mode



This mode is for tuning or scanning the band when looking for a channel on which to operate, when you don't have a specific frequency in mind. In this mode, the DIAL knob and arrow keys each tune the band in the selected step size, or in 1-MHz steps, and the scanning function tunes in the selected step size. The FT-51R has two independent VFOs, A and B, for the main channel, and two more for the sub channel. These are toggled by pressing  when receiving on either VFO. An **A** or **B** to the upper-left of the frequency shows which VFO is currently selected.



Memory Mode

This mode is mainly for operating on specific channels known in advance (and stored in the memories). For example, after storing the frequencies of your local repeaters, you can confine operation to those channels by selecting the

memory mode. In this mode, the **DIAL**,  /  keys and scanning function select stored memories. The FT-51R provides up to 70 memories with 2 call-channel memories (plus 8 special-purpose memories), each of which can store repeater shift direction, CTCSS settings, and separate receive and transmit frequencies.

Each memory has a *Memory Tune* mode which lets you tune just like the VFO mode, and store the resulting re-tuned memory into the same or another memory. This and other special memory mode functions are described later, but you will want to keep these terms in mind.

You can tell at a glance which frequency selection mode is active for each band by looking for either a small **"A"** or **"B"** appearing above and to the left of the first frequency digit. This indicates you are in the VFO mode. If you see a number or name in the bottom of the display (such as  or ) , you are in the memory mode.







The  key switches from the VFO mode to the last-used memory, and  switches from the memory mode to the last-used VFO. While in the memory mode, your previous VFO mode selections are preserved.

User Help Messages

The FT-51R incorporates a bank of pre-programmed user-help messages that scroll across the bottom portion of the display to assist in changing various transceiver settings. Most settings have help messages, but some more straight-forward functions (which have display icons indicating their state) do not.

The user help message display the setting name, followed by a brief description and instructions on how to exit. Some functions and settings are intuitive from the key labeling and choice selections, while others are not *so* straightforward. In cases where you are unsure, the user-help can get you quickly back on track.

Note!

To turn off the User-Help messages, press  →  then turn the DIAL until  appears. Next use the  /  buttons to toggle the User-Help message display on/off. Press  or the PTT to exit (display returns to normal).

Some user help messages appear as soon as a key is pressed (such as entering a frequency directly), while others only appear with 2nd-level functions ($\text{GM} \rightarrow$ selected key) or set-mode functions ($\text{GM} \rightarrow \text{O}$). These are covered in detail later, but you should be aware of them now.

Frequency & Step Selection

You can select a new frequency from a VFO, or by tuning a memory. For now, we suggest using the VFO mode. If you see a memory number displayed, press VFO to switch to VFO mode. You can enter a new frequency directly by the numeric keys, or by tuning with the DIAL knob or MHz A and MHz B . See *Locking the Controls* on page 37 if the keys or DIAL doesn't work.

Direct Numeric Keypad Entry

To enter a new frequency directly, just press the corresponding digits using the keypad. When you press the first key, the display clears and only the new digit appears. When you press the last key, the display reverts to normal, showing the new operating frequency to 5 digits (if it's valid), or the original frequency (if it was not: 2 beeps sound).

If user help is enabled, 31R SET appears followed by instructions whenever a keypad digit is pressed.

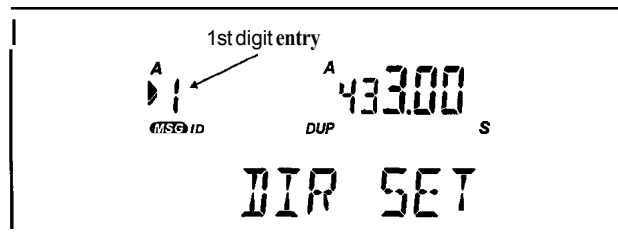

Example: To operate on 440.00 MHz:

Press SAVE GHI 4 \rightarrow SAVE GHI 4 \rightarrow SET O \rightarrow SET O \rightarrow SET O .

If your set covers the 440- to 450-MHz range, you should now see 440.00 displayed as your operating frequency. Otherwise, you should have heard 2 beeps, and the display should be as before (try an in-band frequency).

A shortcut to entering even whole frequencies (such as 440 MHz, 445 MHz) is to use the VFO key trailing the 10's or 1's of MHz digit entry. This truncates the remainder of the frequency to zeros. The 440.00 MHz example above could have also been entered this way:

Press SAVE GHI 4 \rightarrow SAVE GHI 4 \rightarrow PRI F VFO

Default Step (kHz)	Digits Place	Valid Entry
5/10115	1 kHz	SET 0 or 5 only. <small>SCOPE INL</small>
12.5125	10 kHz	<small>SAVE GHI</small> 4 & <small>DUP WXY</small> 9 invalid, others are rounded to nearest valid 12.5- or 25-kHz channel.
20	10 kHz	<small>SET</small> 0 ~ <small>DUP WXY</small> 9 valid, but 5, 12.5 or 25 kHz channels cannot be entered*.
50	10 kHz	<small>TSET ABC</small> 2 , <small>SCOPE INL</small> 5 , <small>STEP PRS</small> 7 , & <small>SET</small> 0 only.

Remember to match the 1-kHz and 10-kHz *digits place* entry of the frequency to the default channel (tuning) step size. While some entries are valid, others are rounded to the nearest 12.5-kHz or 25-kHz channel, or else rejected. The table above outlines which combinations (key entries) will work. To avoid this, *splinter tuning* can be enabled (see the box on page 27).

Tuning

You can turn the DIAL or press **MHz A** / **MHz B** to tune in the selected step size. If you press *and hold* a **MHz A** / **MHz B** key for continuous tuning, you need to release it and then press it again momentarily (to stop, and prevent scanning). One-MHz steps are also available: press **GM** before press-

ing either **MHz A** or **MHz B** (and hold for repeated stepping), or press **@@** and turn the DIAL.

Default channel (tuning) steps are 25 kHz for UHF and 5 kHz for VHF in U.S.A. versions. To select another step size, press **GM** → **STEP PRS** **7**, turn the DIAL for the desired steps, then press the **PTT** to return to normal operation.

Dual In-Band & Reverse Receive

You can simultaneously receive on two VHF or two UHF channels (*dual in-band*), or else receive UHF on the left and VHF on the right (*reverse receive*). Dual in-band receive may be useful, for example, to simultaneously monitor both the input and output frequency of a repeater.

Dual in-band and reverse receive are accomplished by first using direct keypad entry of the desired frequency on the alternate display. In other words, if there currently is a VHF frequency on the left display (the normal situation), just enter a UHF frequency after designating the left display as the "active" band. Afterwards, the DIAL or **MHz A** / **MHz B** can be used normally for tuning or scanning operation on either receiver.

Notice!

VHF channels are normally received on the left display, and UHF on the right. When UHF is received on the left, or VHF on the right, receiver input band-pass filtering is not optimum. This may result in reduced sensitivity and degraded intermodulation immunity in the receiver tuned to the "alternate" band, especially in areas with high RF energy environments. In this case, you may have to limit reception to the normal band until you move to a less RF-congested area.

Spectrum Scope Operation

The spectrum scope allows viewing operating activity on channels above or below the current operating channel in either the VFO or MR (Memory Recall) mode. In the VFO mode, the display indicates the relative signal strength on channels immediately adjacent to the current operating frequency. In the MR mode, the display indicates relative signal strength on the *next-to-be-selected* memory channels either side of the current channel number, irrespective of their actual frequencies.

By default, the spectrum scope is enabled by pressing $\text{[M]} \rightarrow \text{[5]}$. To have it automatically

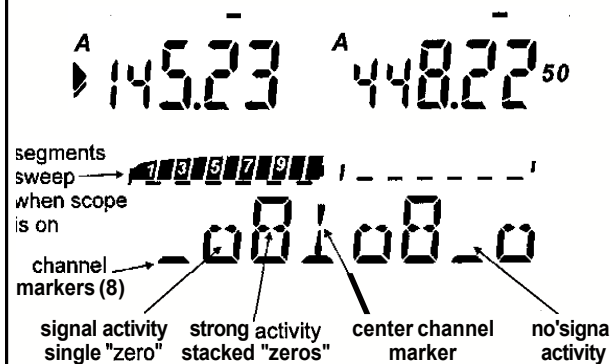
Spectrum Scope Display Indications

activate any time you rotate the **DIAL**; press $\text{[M]} \rightarrow \text{[O]}$ and turn the DIAL to select **5** [5] **SCOPE ON**. Press [MHz A] or [MHz B] to select **DIAL** (automatic) or **F-5** (manual).

When the scope is activated, either the left or right LCD bargraph segments roll from left to right, indicating the scope is "sweeping" for activity on that band. The colon near the middle of the lower display is the center-channel marker (the channel frequency displayed above the sweeping bargraph segments). The individual or stacked zeros that appear indicate the relative signal strength of stations.

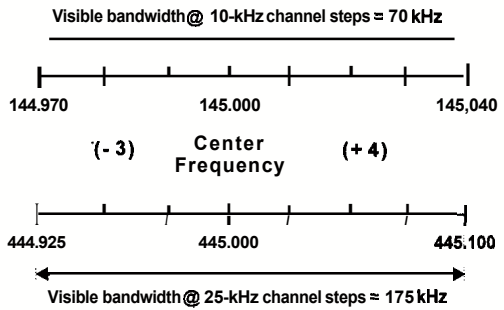

Comparison of Spectrum Scope Visible Bandwidth

When operating from a VFO, *eight* channels are viewed per sweep. The visible bandwidth, however, depends on the selected channel step size (see the comparison on the next page), so match the default channel steps with the amateur band you are using. During memory operation, the scope shows activity of the four memory channels above and *three* below the displayed memory.

The Spectrum Scope starts sweeping on the Main Channel, so press BAND OFF (BAND) first if you want to select the other band to view and operate on. You can press BAND OFF (BAND) at any time to switch operation to the sub-channel, however, the spectrum view remains on the initial band (indicated by the rolling bargraph segments), until changed.

Start sweeping for activity by either pressing SCPE JKL (M) → 5 or turning the **DIAL**. Tune until you can *see* station activity, then slowly turn the **DIAL** until a station is centered in the center-channel marker (colon). To turn the scope off and operate on the centered (and displayed) channel, *simply press the PTT momentarily*. The spectrum scope remains off until manually or automatically activated again.

Transmitting

Follow the procedure described on the next page to select the desired transmitter power level. For all *low* power levels, "**LOW**" is displayed at the top center of the display.

To transmit, press and hold the PTT while speaking into the microphone (at the bottom of the front panel). During transmission either the VHF or UHF LED glows red, and the bargraph meter shows relative transmitter power output. Release the PTT to receive.

Note! Sub-channel receiver audio can inadvertently be re-transmitted along with your voice. To prevent this from occurring, turn off the sub-channel (press BAND OFF (M) → BAND OFF (BAND)). To operate cross-band full-duplex (for telephone-style con-

versations or with a personal autopatch), refer to the next section - *Duplex Operation*.

In European versions, press the oval just below the PTT switch to transmit a 1750-Hz Burst Tone to access repeaters that require it.

Transmitter Power Selection

To select high and low power settings, press (BM) → (3)^{LOW DEF}, then (3)^{LOW DEF} again. With L1 displayed, select one of four low power settings (L1, L2, L3) by rotating the DIAL (see the table below). The bargraph shows a reference of each

RF Output/Battery Comparison

Level	FBA-14 FNB-31, -33		FNB-35		FNB-38	
	watts*	A*	watts	A	watts	A
L1	20mW	0.20	20 mW	0.20	20 mW	0.20
L2	0.5	0.55 0.50	0.5	0.55 0.50	0.5	0.55 0.50
L3	1.5	0.90 1.05	1.5	0.90 0.80	1.5	0.90 0.80
H1	2.0	1.05	3.0	1.20	3.0	1.20
	1.5		2.5	1.10	2.5	1.05
H2	2.0	1.05	4.0	1.35	5	1.50
	1.5		3.5	1.50		1.65

* upper values are for VHF, lower are UHF
Note that all values listed are approximate.

power level during setting and when transmitting. Press the PTT or wait 3 seconds to save your selection and exit.

Cross-Band Full Duplex Operation

Cross-band full-duplex operation offer great versatility for users that want "telephone-style" conversation or when using personal duplex telephone autopatch units. Some inherent problems with this type of operation are:

- Audio from stations received on the sub receiver while transmitting can sometimes be heard over your voice audio.
- With cross-band full-duplex operation, speaker audio can sometimes be conducted to or picked up by the internal mic, resulting in audio feed-back (howling).

Note!

Full-duplex operation is not possible on dual in-band frequency pairs (V&V, U&U) or if the main and sub-channel receivers are reversed. You may still transmit, but the sub-channel receiver is disabled (DUP icon turns off) as long as the PTT is held.



Although you can turn down the sub-channel volume each time you transmit (inconvenient), or use a headset or external speaker-mic with earphone attached (cumbersome), an easy way to obtain hassle-free operation is to use the duplex function of the FT-51R.

The duplex function has three selectable modes:

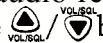
Off (*DUP* not displayed) – The sub-channel receiver is *disabled* during transmit (sub-channel display remains but reception is disabled).

Normal Audio (*DUP* displayed) – Sub-channel is enabled during Tx and audio remains at its normal level, as set with the  buttons.

Reduced Audio (*DUP* blinking) – Sub-channel audio level is *always reduced*. This mode is recommended for cross-band full-duplex operation to reduce audio feedback.

Select the desired mode by pressing  → , repeating as necessary for the corresponding display indication (*DUP*).

The microphone is located at the bottom of the transceiver front panel to provide maximum distance (audio isolation) from the internal loudspeaker. This physically reduces audio feedback and sound conduction from speaker to microphone via the transceiver case.

For full-duplex telephone-style operation, the radio can be held to your ear and operated "cellular-telephone" style, keeping the PTT depressed continuously. Since this can heat up the transceiver (and your hand!) considerably, we first recommend selecting a low power* setting if extended transmit periods are expected.

***Note** - Either the economy low (E L) or low (L) power output setting is ideal for this type of operation.



Caution!



Avoid transmitting at high power for a long time to prevent overheating the radio (especially during 9.6 volt operation). A thermal sensor in the FT-51R monitors internal temperature and automatically reduces transmit power to protect your radio if it gets too hot.

If this occurs, a blinking "LOW" indicator turns on, and the transceiver automatically switches to low power output. You should stop transmitting at this time and let the transceiver cool down. Continued transmission will cause the protective feature to inhibit transmitting completely until the transceiver has cooled down sufficiently.

Sub-channel Receiver Mute



With dual receive capability, there will be many instances when audio from both receivers will be heard simultaneously. Aside from be occasionally annoying, you might also miss important information such as a QTH or callsign from the desired station.

The FT-51R's mute feature enables the main-channel receiver to always have priority. Any station's audio received on the sub-channel receiver is automatically and instantly muted, only allowing main-channel audio to be heard. This saves the inconvenience of manually reducing the sub-channel audio using the  /  buttons.

To enable this feature, simply press  → , *MUTE* appears just below the right receiver frequency display. You still have S-meter and LED indications of activity on the sub-channel, but their audio will not be heard while the main-channel is busy. Repeat the key sequence shown above to disable the sub-channel receiver mute feature.

Repeater Splits

The FT-51R offers three methods to set up split transmit/receive operation for repeaters: manual, automatic and independently-stored Tx/Rx frequencies. Both manual and automatic methods shift the transmit frequency above or below the receive frequency by a programmable offset, preset at the factory to 600 kHz for VHF in all versions, and 5, 7.6 or 1.2 MHz for UHF, in versions A, B and C, respectively. Note that only one offset at a time can be used with the manual and automatic methods. Use the independent transmit frequency method when you want to store other offsets, such as frequencies of repeaters with non-standard splits. This is described later under *Storing Independent Transmit Frequencies*.

To activate the standard shift manually, Just press  →  for minus shift, and press  again for plus shift, and again to return to simplex. A small “-” or “+” sign appears above either display to indicate the current shift direction, when activated.

Example: To operate through a 447.50/442.50 MHz repeater (or substitute another pair if this is not used in your area):

Automatic Repeater Shift

The ARS (Automatic Repeater Shift) feature in the FT-51R activates repeater offset automatically whenever you tune to the standard repeater subband. With this feature enabled, a small “-” or “+” at the upper center of the display indicates that repeater shift is active (without your having to activate repeater shift manually), and closing the PTT changes to the (shifted) transmit frequency.

The subband range over which ARS feature operates is determined by the version of your transceiver, please refer to the chart shown below.

ARS - Repeater Subbands (version A)

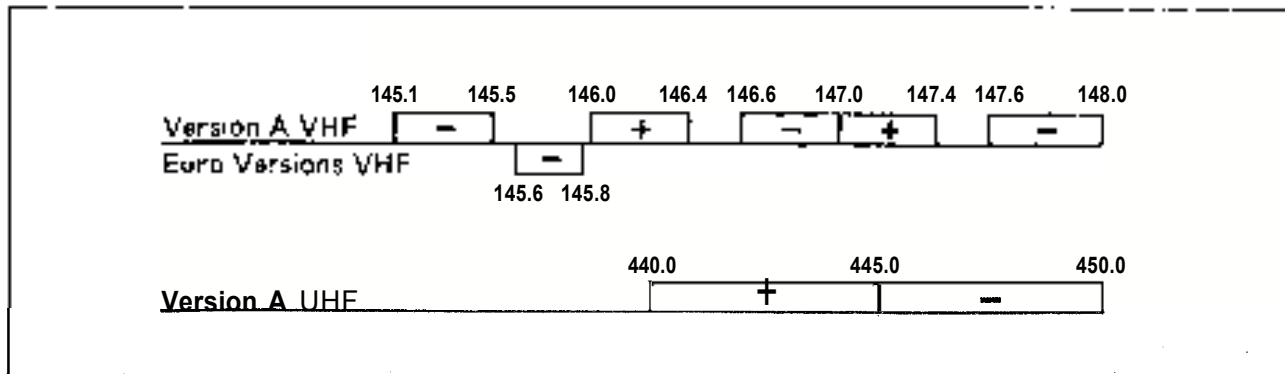

The ARS function is enabled at the factory. To disable it:

- Press **(GM)** → **(O)**^{SET}, then rotate the **DIAL** so that **SEE IS ARS SET** appears.
- Now you can press **(▲)**^{MHz A} or **(▼)**^{MHz B} to toggle the ARS function **ON** or **OFF** (as reflected to the right of the **▶** icon).
- Press the PTT switch or wait to the conclusion of the message scroll to exit.



You can use the manual shift method (**(GM)** → **(6)**^{RPT MNO}) at any time to select a new shift state, whether ARS is activated or not. However, if you change frequency with ARS activated, manual repeater shift selections are canceled.

Memory Storage

By default, the FT-51R offers 40 programmable memory channels for each band. These consist of 35 regular memories along with 5 special-purpose memories. Each memory is labeled CH1~35, L1, L2, U1, U2 and CALL. Alphanumeric names (up to eight characters in length) can be entered in place of the default labels if so desired (see *Naming Memories* on page 33). Regular memory capacity can be expanded from 35 to 55 channels, *but the alphanumeric naming capability must be disabled*. If you don't plan to use memory naming, and would rather have expanded memory capacity, read the procedure and notice in the box below.

Expanding Memory Capacity

To expand regular memory capacity to 55 channels, you must disable the naming feature. **Notice!** Previously-stored channel data and names will be lost when performing this procedure.

Turn off the radio, then press and hold both  &  while turning the power on again. Repeat the power-on procedure to restore naming capability (with the limit of 35 regular memories).

Memory Channel Organization

Ch.	Default Operation	Ch.	Expanded Memory Operation
1	These store frequency and operational settings - can also be masked from viewing & selection, and tagged to be skipped while scanning. Each memory can be given a 8-character name, which is displayed automatically.	1	Same as default operation, except that alphanumeric naming capability is lost and the regular memory capacity is expanded from 35 to 55 memory channels. Other operational settings remain the same.
2		2	
34	As above, but can be used in pairs to set upper & lower limits for PMS and Memory Tuning.	54	As above, but can be used in pairs to set upper & lower limits for PMS and Memory Tuning.
35		55	
L1	As above, but can be used in pairs to set upper & lower limits for PMS and Memory Tuning.	L1	As above, but can be used in pairs to set upper & lower limits for PMS and Memory Tuning.
U1		U1	
L2		L2	
U2		U2	
CALL	Instant-recall CALL ch.	CALL	Instant-recall CALL ch.

Each memory can store separate receive and transmit frequencies or repeater shift, and CTCSS tone data (also refer to the memory organization table above). Memory CALL (the Call channel memory) is recalled instantly by pressing , and the L1 & U1 and L2 & U2 memories can be used in pairs to store the programmable tuning and scanning limit as described later, in addition to general purpose operation.

To store a frequency in memory:

- Select the desired frequency (and repeater split manually, if desired) in the VFO mode as already described.
- Hold **(GM)** 1/2-second (until a second beep sounds). The **(F)** icon appears blinking.
- Within five seconds of pressing **(GM)**, turn the **DIAL** or press **(MHz A)** or **(MHz B)** to select the desired memory for storage. If you select one that is already being used (stored with data), it will be overwritten with new data in the next step.
- Press **(GM)** again momentarily to store the displayed data into the selected memory. The memory label stops blinking for a second, then disappears as operation continues in the VFO mode. If you timed out, nothing new was stored into the memory (simply start again).

Example: Store the 447.50/442.50 repeater data in memory 5.

- First set up the desired frequency and offset on the VFO (see page 18).
- Hold **(GM)** for 1/2-second (**(F)** blinks) so the memory channel number is displayed, then do the next step within 5 seconds.

Note!

If you attempt to store new channel data in a previously programmed memory, **USE** blinks next to the channel number to warn that you are about to overwrite a memory. Make sure you have the correct memory selected before overwriting.

- Turn the **DIAL** or press **(MHz A)** / **(MHz B)**, if necessary, so that **CH 5** (the memory number to store) blinks in the lower display.
- Press **(GM)** again, momentarily. That's it. The VFO data has been stored in memory 5, and you are left operating on the VFO.

Turn the **DIAL** to change the VFO frequency, then press **(MR)** to change from the VFO to the memory mode. You should see **CH 5** appear in the display bottom, and **447.50** (the receive frequency) should appear on the top right of the display. You can press **(REV)** to confirm the transmit frequency of 442.50 MHz. Any memory can be used with the same result except **EMLL**,

which requires a slightly different procedure. Notice that pressing **(MR)** from the VFO mode always recalls the *last stored or used* memory.

Recalling Memories

In confirming the results of the last example, we used $\overset{\text{SKIP}}{\text{MR}}$ to change from the VFO mode to the memories after they were stored. The channel number appears at the display bottom whenever operating on a memory.

After at least one memory has been stored, you can select memories for operation using the **DIAL**, $\overset{\text{MHZ}}{\text{▲}} / \overset{\text{MHZ}}{\text{▼}}$ or by direct keypad access. If you use the arrow keys, press and release the key for each memory: if you hold the key down for 1/2-second, memory scanning will start. In any case, only pre-stored memories are displayed: empty memories are skipped. For direct keypad access, simply enter the number of the memory channel you want, followed by the $\overset{\text{SKIP}}{\text{MR}}$ key.

Example: to access memory channel 5, simply press $\overset{\text{SET}}{\text{0}} \rightarrow \overset{\text{SCOPE}}{\text{5}} \rightarrow \overset{\text{SKIP}}{\text{MR}}$.

Note: Memories L1, U1, L2 & U2 can be accessed directly in a similar fashion, *without* entering the $\overset{\text{SET}}{\text{0}}$ preceding the channel number:

L1 - $\overset{\text{TONE QZ}}{\text{1}} \rightarrow \overset{\text{SKIP}}{\text{MR}}$	U1 - $\overset{\text{TSET ABC}}{\text{2}} \rightarrow \overset{\text{SKIP}}{\text{MR}}$
L2 - $\overset{\text{LOW DEF}}{\text{3}} \rightarrow \overset{\text{SKIP}}{\text{MR}}$	U2 - $\overset{\text{SAVE GHI}}{\text{4}} \rightarrow \overset{\text{SKIP}}{\text{MR}}$

To exit the memories and return to the last-used VFO, press $\overset{\text{PRI}}{\text{VFO}}$.

Call Channel Memory

The Call channel memory for each band can be instantly recalled by the $\overset{\text{DTMF}}{\text{CALL}}$ button. **CALL** appears below the frequency display for the respective band. The Call channel memory is set to bottom edge of the band, but you can reprogram it with any frequency and repeater state, or even a separate transmit frequency.

To store the current VFO data in the Call channel memory, hold $\overset{\text{M}}{\text{GM}}$ for 1/2-second, then press $\overset{\text{DTMF}}{\text{CALL}}$. To store a separate transmit frequency in the Call channel, after storing the receive frequency, tune the VFO to the transmit frequency and repeat the above, but this time *holding* the PTT switch *while* you press $\overset{\text{DTMF}}{\text{CALL}}$.

Storing Independent Transmit Frequencies

All memories can store an independent transmit frequency, for operation on repeaters with non-standard shift. To do this:

- Store the receive frequency using the method already described under *Memory Storage* (it doesn't matter if a repeater offset is active).
- Tune to the desired transmit frequency, then press and hold $\overset{\text{M}}{\text{GM}}$ for 1/2-second to display the memory label again.

- Press and *hold* the PTT switch while pressing @once more momentarily (this does not key the transmitter).

Whenever you recall a separate transmit frequency memory, “- +” appear together above the appropriate frequency display. Again, you can press (REV) to display the transmit frequency, and the shift symbols will blink. You can also press (GM) → (6) to cancel repeater shift (temporarily, until you change channels).

After storing a memory with a separate transmit frequency, rewriting the receive frequency *also* deletes the separate transmit frequency.

Tuning Memories

While receiving on a recalled memory, you can retune it and change other memorized settings (such as repeater shift) by first pressing (MR). *MT* now precedes the memory channel number, and you can tune in the same way as described before (including 1-MHz steps). To store a new frequency or setting in the current (or other), memory: press and hold (GM) for 1/2-second, select a new memory (if desired), and press (GM) again momentarily. Operation remains on the (new) memory as the old memory reverts to its original state.

Once you have retuned a memory, if you don't want to save your changes, just press (MR) to return to the original memory data.

Masking Memories

If you regularly move from one area to another, you may want to use certain memories at specific locations or times. You can temporarily mask undesired memories from operation (except memory channel 1), and re-enable them any time later when needed. To do this:

- Recall the memory to be masked, then press and hold (GM) for %-second (until **F** blinks).
- Press (MR): the display changes to the memory channel 1, and the previously selected memory is no longer selectable manually, or by scanning (described later).

To unmask a hidden memory for operation,

- Recall any memory, then press and hold (GM) for %-second (until **F** blinks).
- Use the **DIAL** or (MHz A) / (MHz B) to select the memory to be restored, then press (MR) to finish.

Note! Be careful not to overwrite hidden memories accidentally (you cannot recover the previous contents).

Naming Memories

You can assign alphanumeric (A/N) names up to 8 characters long to the memories, and have those memories displayed by name rather than frequency. Memories that have not been named are still displayed in the usual [H 1, [H 2 .. format, so you can mix and select the way memories are displayed.

A choice of 60 different characters is available, with 24 special-purpose symbols to customize your name tags (see the table on page 60). After programming frequency and operating settings into a memory, you can assign it a name (see the box below).

Important!



If you performed the memory expansion procedure on page 29, you must first disable it in order to name memories. Remember that regular memory capacity is again reduced to 35 memory channels. Notice! Previously stored channel data will be lost when performing this procedure.



To disable expanded memory operation (and permit naming memories), turn off the radio, then press and hold both **[M4]** & **[F5]** while turning the power on again.

- First recall the memory you wish to name. Press and hold **[M]** for 1/2 second, then release it and press **[MS9]**. At this point the lower display should clear, except for "u" blinking in the first character's place.
- Rotate the DIAL. A character immediately appears blinking in the left-most place of the display. Continue rotating the knob until the desired letter (number or symbol) for the first place appears.
- Next press **[REV]**, this enters your selection in the first character's place, and moves to the next place to the right (the place remains blank until you rotate the DIAL, as before). If you make a mistake when entering characters, you can press **[BAND]** to reverse (backstep) one character at a time and make corrections.
- Repeat the last two steps to enter characters into the desired places. When finished, press **[MS9]** to write the name and exit.



If you later want remove a name, you can do this with the following procedure. Remember that this procedure does not "mask" the name but *erases* it, so it must be entered again.





- Recall the memory, press **[M]** for 1/2 second or longer, then press the **[MS9]** button. Next, press

 on the left side panel of the radio to clear the name, then .

Note: Named memories are tuned like other memories (using  → **DIAL** or  / ). However, **M^T** appears in place of the name until memory tuning is canceled.

Scanning

Before scanning, make sure the squelch is set to silence background noise. You start scanning by holding  or  for 1/2 second. If the transceiver is in the VFO or memory tune mode, band scanning will result. Otherwise, in normal memory mode, only the memories are scanned.

Scanning pauses when a signal opens the squelch, and the decimal point in the display blinks. If you would like the LCD & keypad to illuminate at this time, the Scan Lamp can be enabled: press  → , select **SEE IS SCAN LMP** and use  /  to enable/disable it.



When band scanning, a double beep sounds each time the scanner reaches the band edge, unless the beeper is disabled (page 16). Scanning resumes according to how you set the scan resume mode, described in the box to the right.





Scan Resume Mode Selection



The FT-51R offers a choice of three selectable scan-resume modes:

Pause – Scanning pauses for as long as the carrier keeps the squelch open, then resumes when the carrier drops (squelch closes again).



5-second – Scanning pauses for five seconds, then resumes automatically, whether the signal still remains or not. This is the default scan resume mode.



Halt – Scanning halts on an active channel and stops (does not resume). Scanning must be restarted manually by holding either the  or  button. The Scan Lamp is disabled in this mode.

To choose the scan-resume mode, press  → , then rotate the **DIAL** to select **SEE 4 SCN MODE**. Press  or  to select **P** (pause), **5** (five-second) or **H** (halt) as displayed at the top right. Press  or the PTT to exit.

You can stop the scanner manually by pressing the PTT switch, or the  keys, which will leave operation on the current frequency. Scanning is also halted by  or , but operation shifts to the respective new frequency, in these cases.

Memory Skip Scanning

When you have some very active channels stored in memories, you may wish to skip them when scanning, but still have them available for manual selection. You can mark a memory to be skipped by pressing  →  while receiving on the memory. **SKIP** appears just above the 100's & 10's of MHz digits, indicating that this memory will be skipped during scanning (although you can still recall it manually).

To cancel scan-skip and allow the memory to be scanned, repeat the steps used to disable it; select the memory manually, and press  → .

Programmable Subband (PMS) Limits

Besides band and memory scanning, the FT-51R can also scan only between two frequencies of your choice (with the selected channel steps).

The limits are stored in two pairs of special memories labeled **L 1 & U 1** and **L 2 & U 2**:

- Store the lower edge of the desired scanning range in memory **L 1**, and the upper edge in memory **U 1** (or **L 2 & U 2**).
- With either of the memories recalled, press  to enable memory tuning. You should see **PMS 1** appear at the display bottom when using the **CHL 1/CHU 1** pair, or **PMS 2** for **CHL 2/CHU 2**.

Your tuning and scanning range is now limited to the resulting subband. If ARS or manual repeater shift is activated, the offset is applied automatically when you transmit (even if the resulting transmit frequency is outside the subband limits). Memories **L 2 & U 2** work together the same way.

Note: The frequency resolution of subband limits is 100 kHz, although the channel resolution of the **L & U** memories is the selected channel step size. Therefore, the actual limits are the frequencies stored in these memories *rounded down* to the nearest 100 kHz. Since the memories themselves are not limited to a specific frequency you can still use them for other purposes within the 100-kHz range above the intended limit.

Example: To limit reception to 445.0 – 446.9 MHz

- Tune a VFO to any channel between 445.000 and 445.095 MHz.
- Hold **(M)** for 1/2-second, tune the **DIAL** so that the desired PMS memory channel (let's use **L 1** in this example) appears in the lower display, and then press **(M)** again momentarily. The displayed frequency is now stored to provide a lower subband limit of 445.000 MHz.
- Re-tune the VFO to any channel between 446.900 and 446.995 MHz.
- Repeat the second step, this time selecting **U 1**. This stores the effective upper PMS limit of 446.900 MHz.
- Press **(MR)**^{SKIP *} once to change to memory operation, and then again to activate the 445.000 – 446.900 limits. Tuning and scanning are accomplished in the usual way.

Note that with PMS, as with regular band scanning, a double beep sounds each time the scanner reaches the sub-band edge, unless you have disabled the beeper (page 16).

To release subband limits press **(MR)**^{SKIP *} to return to memory operation, **(VFO)**^{PRI #} to return to a VFO, or **(CALL)**^{DTMP} to switch to the Call channel.

Once the **L** & **U** memory pairs are stored, you can reactivate PMS scanning and tuning just by recalling any PMS memory and pressing **(MR)**^{SKIP *} again. However, you cannot activate the sub-band if one memory of either PMS memory-pair is marked for skip-scanning, or masked (hidden).

Priority Channel Monitoring

The priority function automatically checks for activity on a memory every five seconds while operating on a VFO or other memories. When the receiver detects a signal on the priority memory, operation automatically shifts to that memory while the signal is present (plus a few seconds). If you transmit while paused on the priority memory, priority monitoring ceases and operation stays on the priority memory.

To set up priority monitoring:

- Pre-set the squelch, and store the frequency to be monitored in a memory (this must be memory 1 if you are operating on other memories during priority monitoring).
- Press **(VFO)**^{PRI #} to operate in the VFO mode or else select the memory you want to operate on, and then press **(M)** → **(VFO)**^{PRI #}. **PRI** appears in the lower display, and about every five sec-

onds the displayed frequency and channel number shift to the priority memory briefly while the receiver checks for a signal.

As long as no signal appears on the priority memory to open the squelch, you can tune, transmit and receive on the VFO, or select other memories (memory labels are displayed only while changing). If you hear a station you wish to talk with on the priority memory, press the PTT momentarily while receiving their signal, to stop priority checking. Otherwise, when a signal appears on the priority memory, priority checking pauses, the LCD and keypad illuminate, and the decimal on the display blinks. Priority monitoring will resume according to how you set the scan-resumemode (see page 34). To cancel priority monitoring manually, press VFO^{PRI} .

Note that you can use any memory (besides memory 1) as a priority channel in the above procedure when operating from a VFO. You cannot, however, switch VFOs, or between memory and VFO operation (because pressing MR^{SKIP} or VFO^{PRI} cancels priority monitoring).

Locking the Controls

The PTT, keypad buttons, **DIAL** and volume level can each be "locked" (disabled), to prevent inadvertent transmissions or adjustments. You will find PL , KL , DL or possibly VL displayed singly, or in combination at the bottom left when any of these are locked.

The locking button is located just above the VOLUME / VOLUME keys, and is labeled **LOCK**. Press once to lock and again to unlock.

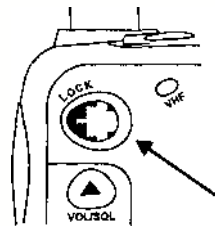

- To set the locking scheme, press EM^{SET} and rotate the **DIAL** to select PL KL DL VL or SEIL .
- To select which functions to lock, press MHz B repeatedly for PTT lock (PL), volume level (VL) or both; or press MHz A repeatedly for keypad lock (KL), **DIAL** lock (DL), or both.
- Finally, press SET or the PTT momentarily to save your new setting and return the display to normal.

Lamp Illumination Settings

Momentarily pressing the LAMP switch lights the LCD and keypad for 5 seconds. If you want to toggle the lamp on and off), press **(M)** before pressing the LAMP switch.

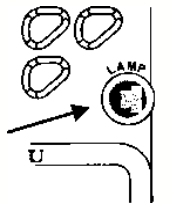

Scan Lamp

If you want the keypad & LCD to momentarily light after the receiver pauses on activity during scanning or priority channel monitoring;

- Press **(M)** → **(SET)**, rotate the DIAL to select **SET IS SCAN LMP** and press **(▲)** or **(▼)** to set the lamp function on or off. Press the PTT to save and exit.

Ringer Lamp

Similarly, you can have the lamp come on while the ringer sounds during CTCSS Bell and DTMF Paging (covered later);

- Press **(M)** → **(SET)**, rotate the DIAL for **SET IS RING LMP** and press **(▲)** or **(▼)** to turn the lamp function on/off. Press the PTT to save and exit.

DC Lamp

When inserting the FT-51R into the PA-10 Mobile Power Adapter, the lamp turns on automatically to illuminate the transceiver for easy viewing at night. This automatic setting can be changed to manual illumination:

- Press **(M)** → **(SET)**, rotate the DIAL for **SET IS DC LMP** then press **(▲)** or **(▼)** to toggle automatic illumination/off. Press the PTT to save and exit.

Power-on Functions

Some default and custom transceiver settings can be activated or changed by pressing certain button combinations while turning the radio on. Refer to the table shown on page 64 for a complete list including reference pages.

CTCSS Operation

The FT-51R can be used to access repeaters that require a CTCSS (continuous, subaudible) tone, and to silently monitor for calls on busy channels. The encode ("**T**") function superimposes a subaudible tone (at a frequency too low to be heard) on the transmitted carrier. The decode ("**TSQ**" — tone squelch) function monitors receiver audio through a narrow filter at the same subaudible frequency, keeping the squelch closed until you receive a matching tone.

To check or set the current CTCSS tone frequency, press → to see the tone frequency displayed in Hz. To change the selected tone, turn the **DIAL** or press or until the display shows the tone frequency you require (the display steps through the standard EIA tones, listed in the table at the right). Press again alone to return to the operating frequency display.

To activate CTCSS functions, press → when the operating frequency is displayed.





CTCSS Tone Frequencies (Hz)

67.0	94.8	131.8	186.2
69.3	97.4	136.5	192.8
71.9	100.0	141.3	203.5
74.4	103.5	146.2	210.7
77.0	107.2	151.4	218.1
79.7	110.9	156.7	225.7
82.5	114.8	162.2	233.6
85.4	118.8	167.9	241.8
88.5	123.0	173.8	250.3
91.5	127.3	179.9	—







With one press, **T** (encode) appears at the top of the display and the tone generator is activated for transmission. Press → again or just if the alternate key functions are still active (displayed) and both **T** and **SQ** (decode) will be displayed together as the tone squelch system is activated for both transmit and receive (only incoming signals "encoded" with the matching tone open the squelch). To turn off the tone squelch features, press → once more.

You can store CTCSS tones (and encode/decode states) in each memory in the same manner (and at the same time) as storing channel frequencies. To change the tone or state stored in a memory, just recall it, reset the tone frequency or function, and store the memory again (press and hold for 1/2-second, release it, and press it again momentarily). If you activate CTCSS on a subband limit memory, it will be active when *that* memory is used to start subband operation.

ATS (Auto Tone Search) Operation

If you hear signals which you suspect (or know) are using CTCSS, but are unsure which tone frequency is being used, you can activate Automatic Tone Search to determine the frequency of the tone(s). To enable ATS, press  →  and listen for the resulting beep(s). If you hear one low-pitched beep, CTCSS scanning is enabled. If you hear a high-low beep sequence, press  again while **F** is still displayed (or else press  →  if it is not). In either case, press the PTT when done.

Once Auto Tone Search is enabled, you can activate it on the current channel frequency:

- First activate CTCSS Tone Squench ( →  and  again, if necessary, until "TSQ" appears).
- Press  →  to display a CTCSS frequency.
- Hold  or  for 1/2 second to begin scanning.

The scanning speed is rapid when no signal is present, and slows to several tones/second when a signal appears, as the signal is checked for a CTCSS tone. When a matching tone is



found, scanning stops, the decimal point blinks, a high-low beep sounds and the display illuminates (if enabled). The CTCSS tone in use now appears on the display. Press the PTT to stop ATS at this point with the CTCSS tone selected. Otherwise, when the received carrier drops, ATS resumes until another signal is received, or until you press the PTT to exit (no transmission occurs).

"CTCSS Bell" Paging

CTCSS Bell operation is an extension of the CTCSS encode/decode function described above: incoming subaudible tones open the squelch. However, it adds two features to make this semi-private operation more convenient:

- (1) The CTCSS Bell mode displays "📞" above the respective band's frequency display. When you receive a matching CTCSS tone, the LCD and keypad illuminate and this bell blinks for a few moments to indicate you received a call. So, by looking at the display you can tell if a call came. You cannot tell, however, who called. That requires DTMF Paging, described later.
- (2) If you are waiting for a call, it is sometimes convenient to have the transceiver "ring" to get your attention. The alert ringer can be set to ring once, several times or can be disabled completely (see page 56).

To activate the CTCSS Bell:

- Tune to the desired frequency then select a CTCSS tone frequency ( → ) as described on the previous page. Note: **TSQ** does not have to be selected/appear in this case.

- Press  four times to select the CTCSS Bell mode. This cycles through the following paging mode/displays:
 - DTMF paging – **PAGE** is displayed below the center of the respective frequency display.
 - DTMF "Trigger" Pager – **T.PAGE** displayed, as above.
 - DTMF tone-coded squelch – **CODE** displayed.
 - CTCSS Bell Paging – 📞 displayed at the upper left, and;
 - No paging (none of the above symbols).

Now all incoming calls without a matching CTCSS tone will be ignored by your receiver. Any call received with the matching CTCSS tone will cause the LCD and keypad to illuminate (unless disabled), 📞 to blink and the transceiver to ring (if the ringer is enabled) as the squelch opens while the caller transmits. Note that other stations do not need to be using the CTCSS Bell function to call you: they can use normal CTCSS functions of their transceiver.

When you reply to a CTCSS Bell call, you may want to turn off the CTCSS Bell function, since otherwise the transceiver will ring every time your squelch opens (unless, of course, you have

disabled the ringer). Just press  once to turn it off. If you have set up normal tone squelch operation beforehand, you can continue your QSO.

You cannot store the CTCSS Bell mode selection in a memory, although you can store different CTCSS tones and encode/decode states.

DTMF Code Squelch & Paging

The FT-51R includes a DTMF (Dual-Tone, Multi-Frequency) tone encoder/decoder and a dedicated microprocessor providing paging and selective calling features. This allows you to place a call to a specific station or group, and to receive calls directed only to you or to groups of your choice.

The paging and code squelch systems use 3-digit numeric codes (000 - 999), transmitted as DTMF (dual, audible) tone pairs. There are eleven Code Memories numbered 1-9, C and P, which store 3-digit DTMF paging codes (these are independent and unrelated to the channel memories and the VFOs).

Your receiver remains silent until it receives three DTMF digits that match those stored in one of its code memories. The squelch then opens so

the caller is heard, and in the paging mode, the LCD and keypad light as the paging ringer immediately sounds (see page 56). When you press the PTT, the same three pre-stored DTMF code digits are transmitted automatically. In the paging mode, three more DTMF digits are sent, representing the 3-digit identification code of the transmitting station.

Like the CTCSS Bell system described previously, the DTMF paging and code squelch systems are selected by pressing . Either the **PAGE**, **T.PAGE** or **CODE** icon appear on the display when DTMF paging, trigger paging or code squelch is activated, respectively. The following descriptions begin with an overview of the various DTMF selective calling features, followed by details of actual operation.

DTMF Code Squelch

The code squelch mode is very simple: both you and the other station communicate using the same 3-digit DTMF sequence, sent automatically at the start of every transmission. Your receiver normally remains silent to all signals that are not prefixed by your selected 3-digit code. When you receive the matching tone se-

quence, your squelch opens and stays open until a few seconds after the end of their transmission.

In the code squelch mode, you must first store and then manually select the one Code Memory holding the 3-digit DTMF code required to open your squelch (as described on the following pages). Also, in the code squelch mode, Code Memories 1 - 9 always function the same — the distinctions and special settings described below for the paging mode do not apply.

DTMF Paging

Standard DTMF Paging uses a specially formatted string of 7 DTMF digits (see below). With DTMF paging, you can receive signals that are prefixed with your personal 3-digit code, or any of up to nine other 3-digit codes.

DTMF Paging Format

Code of Called Station			Flag	Code of Calling Station		
1	2	3	*	4	5	6
DTMF String (7 digits in length)						

When you receive a paging call, the selected Code Memory changes automatically, and the way the display responds depends on which

paging code was received. The key to using DTMF paging in the FT-51R is first understanding how the Code Memories are used.

Code Memory P (Personal Code Memory)

You must choose a 3-digit code to identify your station, and store it in this Code Memory. Usually, you share this code with your friends, club members or anyone you want to be able to reach you by paging.

When a station transmits your personal 3-digit code, the receiver squelch opens, the ringer responds (page 56), and the 3-digit code of the station calling is stored in Code Memory C. At the same time the frequency display changes to show the contents of Code Memory C - which always contains the identity of *the culling station*.

Code Memories 1 - 9

Codes of up to nine other stations can be stored in these memories. These are stations you expect to frequently contact, and whose page calls you also want to receive. Members of a common group or club usually share a common 3-digit paging code so that they can be paged simultaneously.

If the paging code received is *not your personal* code, but matches one of those stored in Code Memories 1–9, the transceiver still responds as before, but the display now shows the Code Memory of the *station that was paged* (rather than the calling station’s ID).

Code Memory C

This Code Memory is reserved for only one purpose - to store the calling station’s 3-digit ID code for later display. This Code Memory is *read-only* and cannot be used to manually store codes like memories 1–9 & P.

If a station pages your personal 3-digit code (stored in Code Memory P), the transceiver *automatically* reverts to Code Memory C and displays the caller’s ID. If the paging code matches one of the other codes stored in Code Memories 1–9, the calling station’s ID is *still* entered in Code Memory C, however, you have to *manually* recall it for viewing.

Note that Code Memories 1–9 can be used to store codes for calling purposes only, or for both calling and receiving, as you desire (see the table at the top of the next column).

DTMF Code Memories

Ch	3-digit DTMF Codes
1–9	Individual ID code of stations you wish to call or monitor stored here.
[*]	Automatically shows ID code of paging station — Rx-only, cannot be written to.
P*	Your personal ID code is stored here.

*memory cannot be selected for page-code inhibit

Remember, with Code Squelch operation (but not with DTMF Paging), you can only receive a call on the currently selected Code Memory, and the display does not change when a call is received. So for code squelch, as mentioned before, the Code Memory distinction does not apply (although you must still store the 3-digit Code Memories).

In either code squelch or paging modes, any DTMF-equipped station can call you. They can use a DTMF keypad to send the three digits if you are in code squelch mode, or seven digits (actually, three digits—”star”—three digits, e.g. 12 3 * 4 5 6) if you are in paging mode.

DTMF Code Monitoring

When a 3-digit DTMF code is received while either Code Squelch or DTMF Paging is active, it is automatically written into Code Memory C. By selecting this Code Memory as described below, you can view what DTMF code was last heard, whether or not it opened your squelch.

Storing Code Memories

The first thing to do before using DTMF Paging or Code Squelch is to store your personal 3-digit code in Code Memory P:

- Press **(GM)** → **(PAGE)** ^{CODE C} to enable the code setting mode (**CODE SET** appears at the display bottom). The frequency display is replaced by a *Code Memory* number at the left, and the corresponding 3-digit Code (**000**, if not used before) at the right.
- Turn the **DIAL** to select Code Memory **P**, which is for your personal DTMF paging ID code.
- Use the numeric keys to enter the three digits you want to use for your ID, then press **(PAGE)** or the PTT to return the display to the operating frequency. Your personal ID code is now stored in Code Memory **P**.

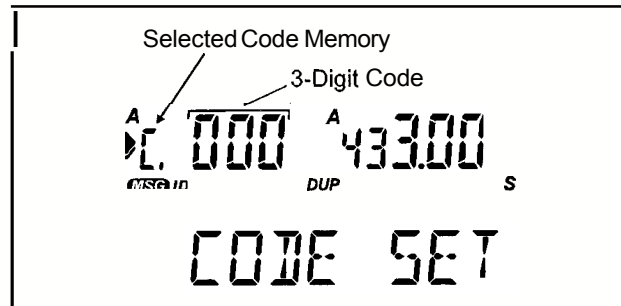

You can use the same procedure to store the Memory Codes of other individuals or groups in Code Memories 1 - 9.

Although up to nine Code Memories can be stored, you might only need a few of them to call your friends or a specific group. Likewise, you'll probably only want your radio to respond to pages directed to you (or maybe your group or club's code). The following explains how to temporarily inhibit unused Code Memories.

Page Code Inhibit

During the Code Memory storage procedure above, when storing Code Memories 1 - 9, you have an opportunity to decide whether your transceiver should respond to incoming paging calls on a particular Memory Code.

After pressing **GM** → **PAGE** to activate Code setting you can press **GM** to toggle DTMF squelch paging capability on and off. When on, that is, when the decoder is enabled to receive paging calls with this Code Memory, a *small underbar* appears beneath the Code Memory digit.

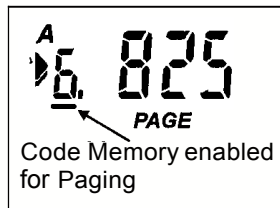

Only enable the underbar for those Code Memories you wish to monitor, it should not appear for others. As mentioned before, this distinction does not apply to Code Squelch (non-paging) operation – the underbar has no effect.

Note that the underbar is displayed permanently on Code Memory **F**, since this is your own ID (that you will always want to receive when paging is activated). Also, the underbar never appears on Code Memory **C**, since this is reserved for the display of incoming codes.

Once you have stored your own ID Code in Code Memory **F**, you can activate the paging or code squelch functions from the normal frequency display by pressing **PAGE**. As mentioned earlier in the CTCSS Bell procedure, repeatedly pressing this key cycles through DTMF paging

(**PAGE** displayed), trigger paging (**T.PAGE**), code squelch (**CODE**), CTCSS Bell paging (**▼**), and no paging (none of these symbols).

DTMF Code Squelch Operation

As described earlier, with DTMF code squelch activated (**CODE** displayed), your squelch will not open until you receive the proper 3-digit DTMF code according to the selected code memory. Likewise, each time you press the PTT, the same 3-digit code is automatically sent to open the other station's DTMF coded squelch.

Using DTMF Paging

Any DTMF-equipped station can call you by sending your 3-digit code, followed by their 3-digit ID Code. When a valid paging tone sequence is received, several things happen:

- The ringer sounds (unless you disabled it, as described on page 56).
- The **PAGE** icon blinks, and the LCD and keypad illuminate (if so enabled).
- The code of the calling station and any following messages (covered later) scroll across across the lower display. The code of the paging station is now stored in code memory **C**.

If you press your PTT switch after receiving a page, the transceiver sends the other station's ID code, a DTMF "star" (*) followed by your own 3-digit personal ID code (Code Memory P) all automatically, and then resets the radio to receive another call.

Unless you are using the Trigger Paging function (covered next), you may want to switch from paging to code squelch mode once contact is established. Just press CODE C PAGE once, so that "CODE" appears. Either you or the other station will also have to select Code Memory C , so that you will both be using the same DTMF code (either, but not both, must re-select their Code Memory).

With the Code Squelch activated in this manner, you will hear three DTMF code digits transmitted when you press your PTT switch. These are the digits stored in the Code Memory currently selected (and displayed in place of the 100's-of-MHz digit if the One Touch Paging option is enabled), and they will open the squelch of the other station.

Therefore, at the start of each transmission, you must wait a second or two after pressing the

Paging Tx Delay

When calling other stations using DTMF Paging or Code Squelch, particularly through repeaters, you may find that some stations are unable to receive your calls. This can be caused by their receiver squelch not opening fast enough (after receiving your transmitted carrier) to allow all of the DTMF digits to be received and decoded.

To correct this problem, you can set a longer delay (750 ms) between the time your transmitter is keyed and the time the first DTMF digit is sent.

Press GM \rightarrow SET O , then rotate the **DIAL** to select SET 6 PAGE DLY . Press MHz A \blacktriangle or MHz B \blacktriangledown to toggle from the default delay (450 ms) to long delay (750 ms).

PTT switch for the DTMF code to be sent (you will hear it in your speaker).



- When you finish your conversation, if you need to reactivate DTMF Code Paging, press CODE C PAGE until **PAGE** is again displayed.

Trigger Paging

This feature is designed to overcome the inconvenience of having to manually switch to and from Code Squelch mode when responding to a page. It can only be used between transceivers equipped with this feature: such as the Yaesu FT-11R/41R, FT-530 and FT-7200.

To activate Trigger Paging, press ^{CODE C}(PAGE) repeatedly until **T.PAGE** is displayed. When a call is received, **T.PAGE** blinks, and the alert ringer sounds. If the other station is also using Trigger Paging, communications can begin just by acknowledging the page: press the PTT and begin talking within three seconds after the DTMF code sequence is sent. The pager resets to receive a new call as soon as either station fails to respond to the other within three seconds.



One-Touch Paging

One-Touch Paging normally displays the Code Memory number in place of the 100's-of-MHz frequency digit whenever DTMF Code Squelch, DTMF Paging, or Trigger Paging is enabled (the rest of the frequency digits remain as before). The  and  keys rapidly select *Code Memories*, instead of tuning or scanning (DIAL operation remains unchanged).

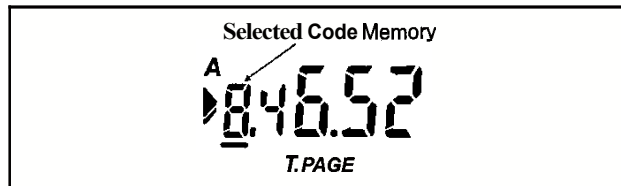
One-Touch Paging Display



To free up (display) the 100's-of-MHz frequency digit for tuning/scanning while in these modes, you may prefer to disable One-Touch Paging. DTMF Codes are now only displayed after pressing  → ^{CODE C}(PAGE), or receiving a page.



To toggle One-Touch Paging on/off, press  → ^{SET}(O) then rotate the DIAL knob for **SET 5** ITP. Use  or  to toggle the mode (ON or OFF). Press the PTT to exit.

Paging "AnswerBack"



When you press the PTT to respond to a page call, the caller's ID code, followed by a DTMF "*" and your personal ID code, are transmitted. This informs the calling station that their page was received. If you prefer, you can have the FT-51R respond to page calls *automatically* (respond).

There are two choices of automatic response - *Answer-Back* and *Page Forwarding*. As mentioned before, the answer-back mode acknowledges a received page by "paging back" the calling station (just as if you manually selected their 3-digit code and pressed the PTT). Page Forwarding takes a received DTMF paging string and re-transmits the *original* sequence (rather than reversing the ID code pair as in answer-back format), relaying the call to extend your paging range.

You can leave your FT-51R with this mode enabled, for instance in your vehicle, office or other vantage point when you are temporarily away, but will be using another transceiver and don't want to miss any paging calls.

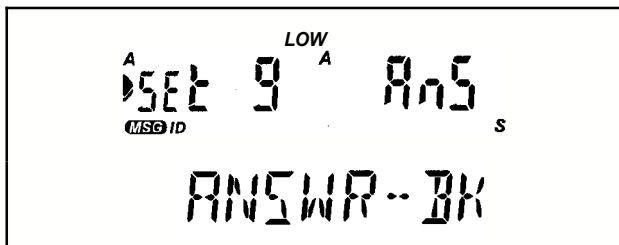
- To enable this feature, press  →  and rotate the **DIAL** until **SET 9 ANSWR BK** appears (as shown below).



- Toggle  or  to step through the response mode choices, shown at the upper right side of the display:

8n5 – Answer-Back

F0r – Page Forwarding

0FF – Automatic response disabled

- Press the PTT to save the entry and exit.

Sending Messages

This feature uses DTMF signaling to send messages to a friend or any group of stations that are set up for message reception. Yaesu FT-11R & FT-41R series transceivers can also be used with this feature. Remember that the message feature is *independent* of DTMF Paging described previously. That is, you aren't required to first page a station in order to send them a message.

Message Format

The FT-51R contains a bank of 10 *outgoing* message memory "slots", one of which is reserved for holding your personal "ID" (name, abbreviation, etc.). Any of the numbers, letters or symbols from the sixty alphanumeric-character set (shown on page 62) can be used in message and ID text. A separate 9-slot memory bank

is used for *incoming* (received) message storage. Once received, these messages are automatically stored to be recalled and viewed later.

Message are sent using a simple format: the message text is composed of up to twelve DTMF characters, always preceded by and ending with a DTMF "#" character, as shown below.

Outgoing Message & ID Format

Flag	Message text (up to 12 characters)	Flag
#	MEETING AT 7	#

Flag	Message ID text (up to 8 characters)	Flag
#	YOUR ID	#

The # flags used at the beginning and end are significant because they identify the DTMF string contained within as a message when decoded. The FT-51R automatically formats your message with # flags, so you only have to enter text as you would like it to appear.

The reserved ID slot uses the same format, and is basically just another message slot. However, when the receiving station is set up for

message and ID reception, it will be handled (and displayed) separately.

Your FT-51R contains ten factory-programmed outgoing messages (including the ID slot) for convenient recall, as shown below. These of course can be overwritten at any time with personalized messages (see next page).

YAESU	GO2RPT
Q5YK	IN CAR
E53U	ATHOME
Q5Y	CALLME
SIMPLX	EMERG

Note: Resetting Alternate Functions

All alternate-function settings (those selected after first pressing **(FM)**) can be cleared and reset to their factory defaults by pressing and holding **(VFO^{PRI}#)** while turning the radio on. All previous settings will be lost.

Selecting Message Operation

When sending messages, you can also have your ID included; "*MSG*" or else "*MSG ID*" appears at the left of the display indicating if one or both are to be sent (and displayed). Likewise, while receiving, this selection determines if the ID will be correctly formatted and displayed when a message is received. Message operation can also be disabled completely, if desired.

To choose the message mode you will use;

- Press **(GM)** → **(MSG^{ID})**, then repeatedly press **(MSG^{ID})** for the desired mode; message, message & ID or disabled (no icon displayed).

Storing Personal ID and Messages (outgoing)

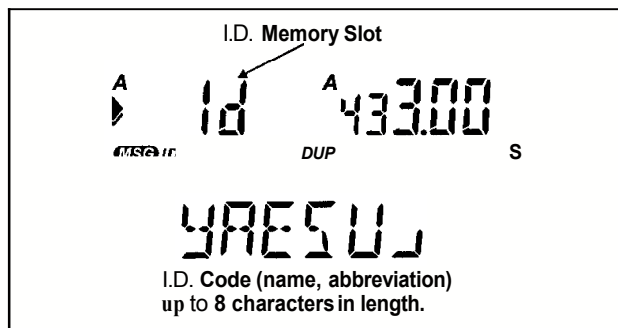

Before sending and receiving messages, you will want to store your personal ID in the special slot reserved for this purpose. Your ID could be your callsign, name or any other identifying characters. To do this:

- Press *and hold* the **(MSG^{ID})** button for longer than 1/2 second; one of the factory message shown at the left (or another previously stored message) will appear in the lower display.
- If not already displayed, press **(▲^{MHz A})** / **(▼^{MHz B})** until **id** appears in place of the main channel fre-









quency display. If the ID slot has not been previously overwritten, the factory programmed **YAESU** ID should appear in the lower display as shown above.

- Hold **(GM)** for 1/2 second so the first character of the ID name blinks.
- Rotate the **DIAL** to select the first character of the message and press **(REV^{RPT SET})** to save the entry and move to the next place.
- Repeat the above step to complete the message. If you make a mistake entering a character, press **(BAND^{BAND OFF})** to backstep to the incorrect character, enter the correction and continue.
- When the desired message is displayed, press **(MSG^{ID})** to save the entry and exit.

With your ID entered, you can repeat this procedure to reprogram the remaining memory slots (use  /  to select a message slot) with any messages you like. Note that **ID** is only displayed when the slot reserved for this purpose is selected.



Sending Messages



Before sending a message, you must first inform the other station to switch his or her transceiver into its message reception mode. With that done, any stored messages can be sent using the following procedure:

- Press  →  as before, until the desired mode (message or message & ID) is selected (indicated by **MSG** or **MSG ID** appearing at the left of the display).
- Press and hold the PTT while also pressing . While keeping the PTT depressed, use the  /  buttons to choose the slot containing the message you want to send, press  then release the PTT. You will hear the DTMF string of the message (and ID if selected) as it is being sent.

Sending Messages Manually

If you do not have a particular message in memory (or the time to store it), you can send it manually by using keypad button combinations. As explained before, message format consists of a DTMF # followed by up to twelve message characters, ending with an additional #. When sending a pre-stored message, the #'s are automatically inserted by the FT-51R's CPU. When sending messages manually, however, *remember to include these.*

Unlike DTMF numerals, which are entered with a single key, letters of the alphabet and other symbols each require a *two-button key sequence*. For example, generating the letter **F** requires manually entering  **7** → . So as you can see, sending messages manually takes a little practice and limber fingers. The table on page 60 shows the key sequences required to generate each of the available characters.

- Press and hold the PTT during the message string; press  **PRI #**, followed by your message, then  **PRI #** again before releasing the PTT.

Receiving Messages

To receive a message, ensure **MSG** or **MSG ID** is displayed in the left of the LCD, as explained before. If not, press **(M)** → **(MSG)** to activate the desired message function. After receiving a correctly formatted DTMF message string, several things happen:

- The message is automatically stored into an open slot in the *incoming* message bank (separate from the outgoing-message bank). Up to nine messages are stored in the order received, and can be recalled and viewed later.
- The ringer sounds and a display header appears, informing you which band the message was received on, and what slot it is now stored in (1–9).

Message Header Display Format

Message & ID Tx/Rx enabled Msg received on UHF band Message Slot Number (1-9)

- Next, the message text slowly scrolls across the lower display. If the Morse annunciator is enabled, the message is decoded and played back in Morse code over the speaker (see page 56).



- If Message & ID operation is enabled, a ID header will appear as below, then;





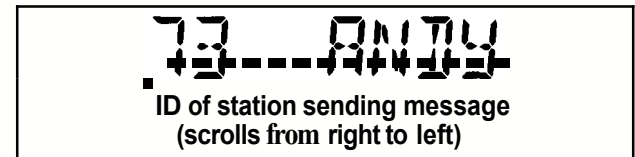

- The ID of the station sending the message slowly scrolls across the display.



- In either case, the message header appears again and the sequence starts over again and will continue until **(MSG)** is pressed.





Messages subsequently received continuously *overwrite* previously full slots on a *first-in, first-out* order, unless *Single* message storage is selected. In this case messages are not stored, and **MSG FULL** appears in the display, (explained later).

To view messages, press  momentarily, recall message slots using the  /  buttons, then rotate the **DIAL** to scroll the stored message across the lower display. Empty message slots are indicated by an asterisk.

To erase *all* stored messages, turn the transceiver off, then press and hold the  button while turning the power on. To erase stored outgoing messages, refer to the box below.

Erasing Outgoing Messages





Stored messages can be individually erased using the following procedure:

First recall the desired message by holding the  button for 1/2 second and using the  /  buttons. Hold  again for 1/2 second, then press  to clear the message.

Message Storage

After receiving ten incoming messages, any subsequent messages normally *overwrite* previously full slots on a *first-in, first-out* order. This is called *Continuous* message storage.

If you like, you can change to *Single* message storing mode, and any additional messages are not displayed or stored (**MSG FULL** appears in the display). This protects previous messages from being inadvertently overwritten:

- Press  → , then select **SET 14 MSG STORE** so that **INT** (the default continuous message storage mode) is displayed.
- Use  or  to toggle between continuous or single (**INT**) message storage.
- Press the PTT to save the change and finish.

Received messages are displayed as before, but only the first ten are displayed and automatically stored for later recall.

Customizing Ringer Settings

The way the transceiver's ringer responds when a CTCSS Bell, DTMF Paging or DTMF Message call is received depends on the ringer configuration you select. Three types of ringer melodies are available:

- Internal Melody (factory-programmed)
- User-programmed Melody
- Morse Code Annunciator (CW decoder)

The CTCSS Bell & DTMF Paging Ringer can be turned off, or else enabled to repeat the selected melody (or Morse announcement) 1, 3 or 5 times when a call is received.

Note: the Morse annunciator *decodes* incoming DTMF tones and replays them via the internal speaker to alert you to incoming calls and their message.

The DTMF Message ringer can be enabled or disabled. However, when enabled it only rings once when using the Morse annunciator. The User-Melody is stored in DTMF Auto-Dial Memory 0 (reserved for this purpose), and is explained in detail later in the chapter (pages 59 & 60). The chart shows possible ringer configurations.

Ringer Function	Repetition (on/off)	Melody Selection
CTCSS Bell	0 (off) 1 3 5	A1 (CW Decode) Internal User
Paging Ringer	0 (off) 1 3 5	A1 (CW Decode) Internal User
Message Ringer	Off On	A1 (CW Decode)

- ❑ To configure the CTCSS Bell ringer, press **BM** → **SET** → **0**. Select **SET 10 BELL RING** for ringer type and **SET 11 BELL REP** for ringer repetition (or off). Use **MHZ A** or **MHZ B** to toggle function selections.
- ❑ For the Paging ringer, use **SET 7 PAGE RING** and **SET 8 PAGE REP**.
- ❑ The Message Ringer only uses **SET 13 MSG RING** to enable or disable the Morse annunciator,

DTMF Auto-dial Memories

Ten memories, numbered 0 ~ 9, store DTMF tone sequences of up to 15 digits each. These can be used for remote DTMF control sequences or telephone numbers for auto-patching systems. Memories 0 & 9 are reserved for a special purpose, and are covered later.

A special mode must be activated to use the DTMF auto-dial memory features, and is toggled on and off by pressing (GM) → (CALL). The (S) icon is displayed at the far right when this mode is active.

To store a DTMF Auto-Dial Memory:

- Press (GM) → (CALL), if necessary, so that (S) appears in the right side of the display.
- Press and hold (GM) for 1/2-second (until the second beep sounds), then within 5 seconds, press a *numbered* key corresponding to the Auto-Dial memory number you want to store.
- Press and hold (GM) again for 1/2-second (() begins to blink), then key in the numbers of the DTMF sequence you wish to store. As you do so, the blinking serial digits place at the left side of the display increments automatically as the entered digits are displayed at bottom.

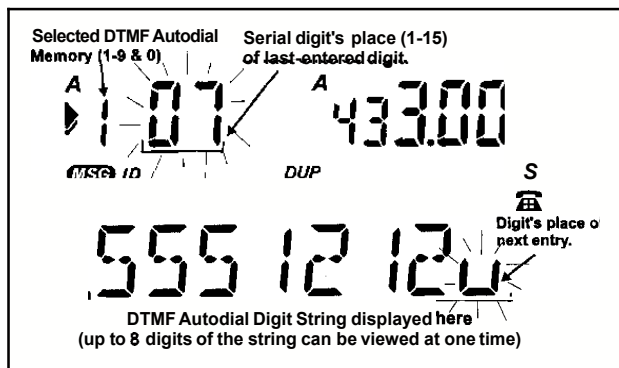

Entering Auto-Dialer digits (example)

Note: when entering new DTMF codes, the two-place serial digit number shows *the next digit to be stored* - indicated by the blinking ω .

If you make a mistake, press (BAND) to backstep and re-enter your digits. To erase an existing Auto-dial memory, enter the Auto-dial program mode () must be blinking), and press (SUP).

- If storing fewer than 15 digits, press (CALL) to finish (if you store the full 15 digits, entry terminates automatically after the last digit).

Press (MHz A) or (MHz B) to select another DTMF memory to store, if desired, and repeat the last two steps, or press (CALL) again to exit and return to the frequency display.

DTMF Auto-dial Memories

Ten memories, numbered 0 - 9, store DTMF tone sequences of up to 15 digits each. These can be used for remote DTMF control sequences or telephone numbers for auto-patching systems. Memories 0 & 9 are reserved for a special purpose, and are covered later.

A special mode must be activated to use the DTMF auto-dial memory features, and is toggled on and off by pressing (FM) → (CALL) ^{DTMF}. The  icon is displayed at the far right when this mode is active.

To store a DTMF Auto-Dial Memory:

- Press (FM) → (CALL) ^{DTMF}, if necessary, so that  appears in the right side of the display.
- Press and hold (FM) for ½-second (until the second beep sounds), then within 5 seconds, press a *numbered key* corresponding to the Auto-Dial memory number you want to store.
- Press and hold (FM) again for ¾-second (00 begins to blink), then key in the numbers of the DTMF sequence you wish to store. As you do so, the blinking serial digits place at the left side of the display increments automatically as the entered digits are displayed at bottom.

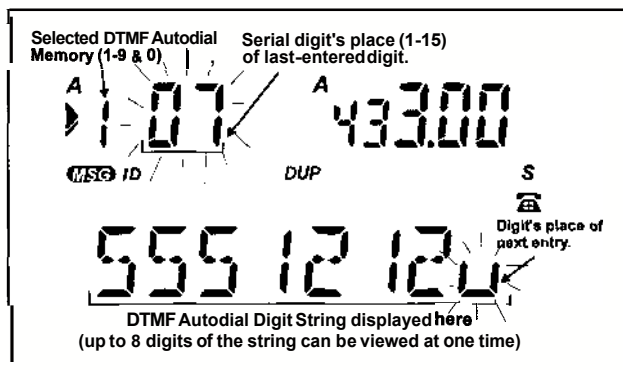



Entering Auto-Dialer digits (example)

Note: when entering new DTMF codes, the two-place serial digit number shows *the next digit to be stored* - indicated by the blinking .



If you make a mistake, press (BAND) ^{BAND OFF} to backstep and re-enter your digits. To erase an existing Auto-dial memory, enter the Auto-dial program mode (00 must be blinking), and press (SUP) ^{OP}.

- If storing fewer than 15 digits, press (CALL) ^{DTMF} to finish (if you store the full 15 digits, entry terminates automatically after the last digit).

Press  or  to select another DTMF memory to store, if desired, and repeat the last two steps, or press (CALL) again to exit and return to the frequency display.

Auto-Dial Memory Playback





You can manually check the contents of DTMF auto-dial memories while  is displayed:

- Hold  for 1/2 second, then press any numbered key (to change the display to auto-dial memories).
- Turn the  /  keys to select the desired auto-dial *memory number*, then use the **DIAL** to select individual digits and scroll the string across the display (from right to left). Note that the serial place of the digit changes accordingly at the top of the display.
- To replay the stored codes in the loudspeaker and on the display, simply press the numbered key corresponding to the DTMF auto-dial memory number stored.



To play back DTMF auto-dial memories on the air, first make sure the DTMF memory mode is activated ("" is displayed). Then close the PTT switch and simply press the number of the auto-dial memory to transmit. Once the DTMF sequence has begun, you may release the PTT (the transmitter stays keyed until the auto-dial string has been sent).

Naming DTMF Auto-Dialer Memories

You may assign a name (up to 8 characters) to each DTMF auto-dial memory, to be displayed when the memory is recalled. This can help you to identify whose numbers you have stored. The same character set and procedure used for naming regular memory channels (pages 33–34) is used for auto-dial memory naming.

- Activate the DTMF Auto-Dial mode by pressing  →  (if necessary, to display the "").
- Press and hold  for 1/2-second (until the second beep sounds). Then press the numbered key corresponding to the desired DTMF memory to be named.

Note!

With the DTMF Auto-Dialer active, the keypad cannot be used to transmit individual DTMF codes. If you do not have the required DTMF sequence stored in memory, turn the Auto-Dial mode off by pressing  →  ("" turns off), then manually enter the desired DTMF codes.

- Press and hold **[GM]** for 1/2-second, then press **[MSG]** to enter the A/N naming mode. Autodial memories are pre-named as **DTMF CH1, CH2..** etc. The first character's place of the name starts blinking, and you can enter the characters of a nametag (as shown below).



- Use the **DIAL** to select characters and the **(REV)** button to move places. When finished with the last character, press **[MSG]** to finish.
- When displaying DTMF auto-dial memories, the A/N name mode can be toggled on/off by pressing **[MSG]**.

Note

DTMF autodialer memory 9 stores the last-received DTMF string, and is read-only. You can select and view this memory at any time to see what numbers were most recently dialed.

Composing the Ringer User-Melody

The default ringer with CTCSS Bell or DTMF Paging operation is factory programmed. You may compose your own melody if desired, and store it in a special DTMF Autodial memory reserved for this purpose. When enabled, the user-melody plays instead of the factory melody.

To enter your own melody:

- Press **[GM]** → **[CALL]** so that **[A]** appears in the right side of the display.
- Press and hold **[GM]** for %second (until the second beep sounds), then within 5 seconds, press **[SET]**. The display appears as below.

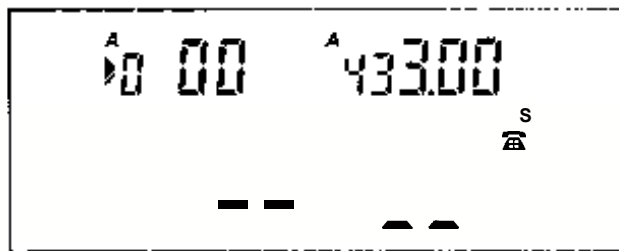

- Press and hold **0** again for 1/2-second (**00** begins to blink), then key in the numbers corresponding to the notes of the melody you wish to store. Refer to the musical scale shown on the next page.

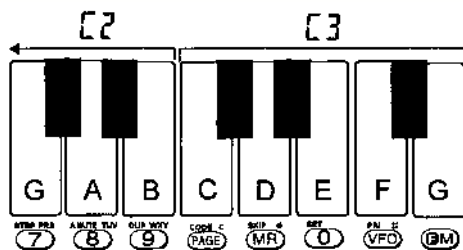
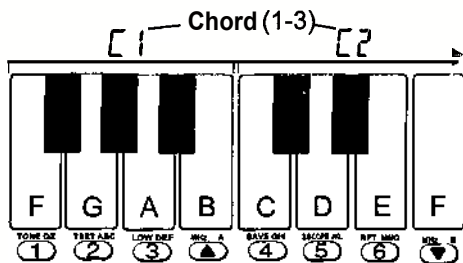

- As you enter the digits (notes), the blinking serial digits place at the left side of the display increments automatically as the entered notes are displayed at bottom.

You can enter pauses between notes by pressing (REV). If you make a mistake, press (BAND) as necessary to backstep to the incorrect entry and then re-enter your notes. Remember that must be blinking before you can enter notes.

- If you are storing fewer than 15 notes, press after the last note to finish, otherwise entry terminates automatically.
- You can press or to select another DTMF memory to store, and repeat the last two steps, or else press again to return to exit to the frequency display.

DIAL Knob Transfer

If you prefer to use the **DIAL** to control the volume and squelch settings, press → and rotate the **DIAL** to select **SET 1 DIAL XFER**, then use or to toggle the feature on/off. Press the PTT to *save* your *entry and exit*.

Now both the **DIAL** and buttons function the same, while VFO and memory tuning/scanning is accomplished using the / buttons. For squelch adjustment, remember to press first.

Other DTMF Settings

The following are additional setting functions of the DTMF keypad that you can customize to your own preference.

DTMF Paging Code Speed

You can toggle the DTMF paging code speed. The default tone duration (fast) is 50 ms (11 digits per second). This can be changed to 100msec. duration (slow – 5.5 digits per second):

Press → and rotate the **DIAL** to select **SET 11 PAGE SPD**.

Press or to toggle **100** or **50** millisecond per tone duration. Press the **PTT** to save your entry and exit.

Note: Do not confuse DTMF Paging Code Speed with DTMF Autodialer playback. Autodialer playback speed is fixed and not selectable.

DTMF Digit Entry - TX "Hold"

When entering a string of DTMF digits, this feature keeps the transmitter keyed for 2 seconds after each key entry without having to keep the **PTT** depressed. This is convenient for repeater or personal autopatch operation when

the number you are dialing isn't stored in a DTMF Auto-dialer memory.

To enable this feature, perform the following:

Press → and rotate the **DIAL** to select **SET 22 DTMF HL D**, then use or to toggle the feature on/off. Press the **PTT** to save your entry and exit.

Extended Rx Range & AM Reception

Receive range can be extended by a power-on sequence. Transmit range is limited to amateur bands only (read the warning on the last page of the manual). This feature may not be available on all versions, in accordance with regulations in the country the FT-51R is shipped to.

Turn the transceiver off, press and hold both the / buttons, then turn the power on again. To return to amateur band-only reception, repeat the power-on sequence.

To enable automatic **AM** reception below 137 MHz (aviation band), press → , rotate the **DIAL** to select **SET 26 AM SET**, then press or to select **A** (for AM) or **F** (for FM) reception (demodulation).

Alpha-Numeric & Special Character Key Code Table

0		A		N		space		?	
1		B		O		(Q/ %	
2		C		P)		&	
3		D	LOW DEF	Q		+		-	LOW DEF
4		E		R		.		\$	
5		F		S		=		¥	
6		G		T		*		\	
7		H		U	AMUTE TUV	/		:	
8		I		V		Δ		<	
9		J		W		μ		>	
		K		X		Σ		■	
		L		Y		:			
		M		Z		!			

To name Channel Memories:

1. Recall memory channel to be named.
2. Press for 112 sec, then press .
3. Use DIAL to choose characters, press to enter.
4. Repeat step 3 as needed to enter all characters.
5. Press to save and exit.

Note: Use to backstep and correct any errors.

To name DTMF (auto-dial) Memories:

1. Press → to display .
2. Press for 1/2 sec, then the number of the autodial memory to be named.
3. Press for 112 sec, then .
4. Use DIAL to choose characters, press to enter. Press to finish.











Set Mode Functions and Selections

Display	Function	pg	Display	Function	pg
SEt 1 DIAL -FR	Transfer VOUSQL control to top-panel rotary DIAL knob.	60	SEt 14 MSG STOR	Select single or continuous message storage.	55
SEt 2 LOCK SEL	Select front panel locking scheme.	37	SEt 15 SCAN LMP	Enable/disable Scan Lamp (while paused)	34 27
SEt 3 KEY BEEP	Enable/disable keypad beeper.	16	SEt 16 AUTO LMP	Enable/disable Auto-On Ringer Lamp.	27
SEt 4 SCAN MODE	Select scan resume (pause) mode	34	SEt 17 PA LMP	Enable/disable Auto Lamp-On (when PA-IO used).	27
SEt 5 1TP SET	Enable/disable one-touch paging	49	SEt 18 POW TIME	Select Auto-Power Off time	65
SEt 6 PRGE DLY	Select normal/long DTMF paging Tx delay (450/750 ms).	48	SEt 19 ARS SET	Enable/disable ARS (Auto-Repeater Shift)	28
SEt 7 PRGE RING	Select Paging ringer type: internal/ user / A1 (Morse).	56	SEt 20 TX SNI C	Enable/ disable Tx Power Saver	66
SEt 8 PRGE REP	Select 0 (off), 1, 3 or 5 DTMF Paging ringer repetitions.	56	SEt 21 PRGE SPD	Select fast/slow DTMF playback digit speed.	61
SEt 9 ANSWR BK	Select paging mode: answer-back, forwarding or off.	50	SEt 22 PTT HLD	Enable/disable PTT hold when entering DTMF tones.	51
SEt 10 BELL RING	Select CTCSS Bell ringer type: internal/ user / A1 (Morse)	56	SEt 23 USER HLP	Enable/disable automatic User-Help messages	19
SEt 11 BELL REP	Select CTCSS Bell ringer repetitions: 0 (off), 1, 3 or 5 times.	56	SEt 24 FREE ENT	Enable keypad entry of "splinter" channels (5-kHz step).	27

Power-On Settings

Some transceiver default operational settings can be enabled/disabled, changed or reset using a power-on procedure. This requires holding a particular key (or key combination) depressed while turning the transceiver on, as outline in the table below. For detailed explanations on how these affect transceiver operation refer to the page(s) listed in the far right column.

Power-On Settings and Functions





Press and hold the following key(s) while turning the transceiver on.	Operational Effect or Setting Enabled	Ref. Page
	Enables Cross-Band Repeat Mode (bi-directional repeat).	69-70
	Enables Cross-Band Repeat Mode (one-way repeat).	69-70
 & 	Enable Extended Receive (110–180 MHz & 420–470 MHz).	61
 & 	Reset CPU and all operational settings to factory-default.	74
	Clear all Alternate Function settings to factory-default.	51
	Test all LCD segments.	74
	Erase all stored incoming DTMF messages.	55
 & 		

Appendix

Extending Battery Life

How long NiCd batteries last between charges or replacement depends largely on your operating habits, and how you care for the battery pack. The FT-51R offers several ways to conserve battery power, and extend the life of each charge. Knowing how to use these features can be critical in emergencies.

APO (Automatic Power-Off)

Obviously, turning the set off when not in use saves battery life, and can also prevent damage that might result to the batteries if they are over-discharged. The FT-51R provides the APO system to turn the transceiver off after 10, 20 or 30 minutes of key inactivity. From the factory, APO is disabled, but you can easily activate it by pressing  → , then turning the DIAL to select **SET 18 APO TIME**. Use  or  to toggle the time-out timer between **10**, **20**, **30** (minutes) or **OFF**. Press the PTT to exit.

When the APO function is activated,  appears at the right side of the display, and a timer starts every time you press a key. If you don't

press any keys for the selected time-out period, and *as long as you are not scanning or priority monitoring*,  will begin blinking, and if you have the key beeper activated (page 16), you will hear a few short beeps about a minute before the transceiver turns itself off. If you don't press a key in that minute, the transceiver turns off. After that, you must switch the transceiver back on for use. If you need to monitor for a long period, or if using an external DC supply, you can deactivate the APO feature in the same manner as described before, so the display shows **OFF**

Receiver Battery Saver

The FT-51R uses an automated battery saver system to reduce current drain during squelched monitoring. With the Battery Saver activated the receiver monitors for 300 milliseconds, then powers down for a preset or variable "sleep" duration (which you select), then turns on and monitors again for 300 milliseconds. This cycle repeats continuously as the receiver checks for incoming signals when active (powered on). When the Battery Saver is enabled, a small **S** blinks near the right side of the display.

You can select from seven receiver *sleep* (power-down) durations, ranging from 300 ms to 1 second, or else enable the ABS (Automatic Battery Saver) mode, which senses channel activity and automatically adjusts the monitor/sleep time ratio according to recent operating history. Refer the table below for a comparison of selectable durations.

Battery Saver Settings

Display (ratio)	RX "On"-time	RX "Sleep"-time
3.30	300 ms	300 ms
0.30	300 ms	350 ms
0.43	300 ms	400 ms
0.50	300 ms	500 ms
0.70	300 ms	700 ms
1.00	300 ms	1000 ms
ABS	300 ms	variable*
OFF	always on	—

* see explanation in text

The battery saver is enabled as supplied from the factory, with ABS selected. You can check or change the sleep duration or disable the Power Saver by pressing **FM** → **4**^{SAVE GHI} and then rotating the **DIAL** to change the current (displayed) saver ratio. Possible selections are shown in the table.

Tx Save

A good operating habit is to use the lowest transmitter power necessary to maintain reliable communications. As described on the box on page 24, the FT-51R offers a choice of five levels of power output: one high and four low — **1** (economy low), **2**, **3** and **4**. Also, the FT-51R can reduce transmitter current drain further with its smart Tx Save feature. This conserves battery life by reducing power output when the microprocessor determines it is not needed. It monitors the signal strength of the last-received signal, then the microprocessor selects one of the four Tx output power levels, according to the received signal strength.

Note that the **1** power level cannot be selected with Tx Save enabled, and if you are using a 4.8-volt battery, Tx Save has no effect (in actual power output) when **4** power level is selected.

Refer to the table on page 24 for power levels with respect to battery voltage.

The Tx Save feature is not enabled from the factory but can be turned on as follows:

- Press **FM** → **SET** (0), then use the DIAL to select **SEE 20 TX SAVE**.
- Press **MHz A** (▲) or **MHz B** (▼) to toggle Tx Save **ON** or **OFF** (default).
- Press the PTT to return the display to normal.

Notice that **S** appears during transmission when the Tx Save function is on (however, if the ABS function is also enabled, it *blinks* during receive and stays solid during Tx—you will have to manually verify if Tx Save also enabled).

Another tip to consider is that if you live in a location where high power is almost always needed, consider using a higher gain antenna instead of opting for high power (the effect on transmissions is the same). Make sure any external antenna is designed for 50 ohms impedance at the operating frequencies of each band.

Beeper Disable

The keypad beeper draws several milliamperes, so you may want to disable it if you need to conserve power while using the keys a lot. Do this by pressing **FM** → **SET** (0) then using the DIAL to select **SEE 3 KEY BEEP**. Press **&** or **MHz B** (▼) to toggle the beeper **ON** (default) or **OFF**. Press the PTT to return to normal operation.

Selective Calling

Obviously, if the channel is quiet, the squelch does not open often, and power drain is minimized (particularly if the Battery Saver is active). Unfortunately, you probably cannot always confine your activity to quiet frequencies. The DTMF selective calling (code squelch, and DTMF paging) features in the FT-51R can be used to essentially make a quiet channel out of an otherwise busy one. When either of these features is active, the squelch only opens (and the VHF & UHF LEDs light) when a signal is prefixed by a 3-digit DTMF code that matches one you have stored in the DTMF Code Memories (see page 46). This can extend battery life considerably.

In cases where you may need to monitor many stations, or some that are not equipped

with DTMF encoders but do have CTCSS, Tone Squelch can be used to make a quiet channel on a crowded frequency.

Earphones & Speaker/Mics

Using the lowest possible volume setting minimizes current drain while receiving. You can hold the transceiver up to your ear and reduce the volume to minimum, but it may be more convenient to use an earphone, speaker/mic or the MH-19A2B Earpiece/Mic, and keep the transceiver clipped to your belt, particularly in noisy environments.



Battery Care

As the battery discharges, the voltage drop (when transmitting) increases. When battery voltage drops to around 4.0 volts,  flashes, indicating the batteries should be replaced or recharged. As battery voltage drops further, the transceiver shuts off.



If using rechargeable batteries, switch the transceiver off and recharge or replace the battery as soon as the indicator begins to blink. Try to avoid recharging Ni-Cd batteries often with little use between charges, as that can degrade the charge capacity and useful life of the cells.

Since it is hard to know exactly when the charge will run out, you may want to carry an extra, fully-charged pack with you to avoid having operation interrupted.

Checking the Battery Voltage

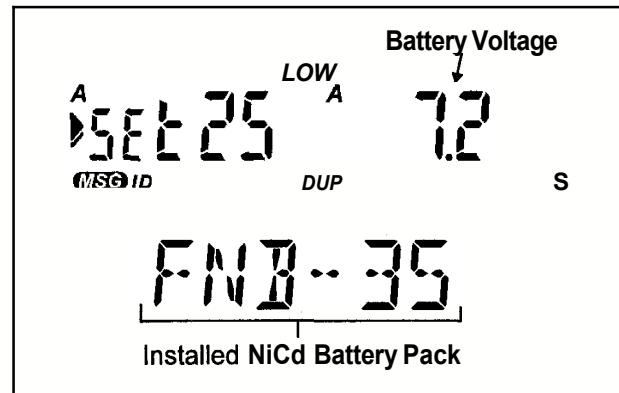
To check the battery voltage, press  →  and turn the **DIAL** to select **SET 25 BATT VOL**. The battery voltage appears at the top, while the lower display scrolls to inform you which Yaesu battery pack type is installed, as shown below. Press the PTT to exit.



Note: To monitor voltage level during receive and when transmitting, first press  before the procedure above. Press  (instead of the PTT) to exit.

Cross-Band Repeater Settings

The FT-51R can be set up to operate as a full-featured cross-band repeater with a simple power-on procedure. This feature is useful for field-day, club station or emergency operation in remote areas, and for cross-band linking. However, remember these few points before using the cross-band repeater function.

- Check with amateur rules and regulations to ensure this type of operation is permitted in your country.
- Pick your frequency pair carefully, so as to not interfere with existing repeaters in operation, cross linking two repeaters on two separate bands may cause a lot of havoc, and may be illegal! If you are not sure of active repeater frequencies, a safe rule is to stay off of the repeater sub-bands and use the simplex portion of each band. *Contact the frequency coordinator for your area for guidance.*
- Remember that the Tx duty cycle will probably be much greater than before, so use a low Tx power output setting for cooler operation.

There are two cross-band repeater selections: one-way repeat and bi-directional repeat. With one-way repeat, any signals received on the sub-

channel are transmitted on the main channel. Bi-directional repeat operates the same way, except, as its name implies, it can repeat signals from either channel (one at a time, of course). Transceiver CTCSS settings (encode/decode) can still be selected for each band, so you can make your repeater "closed" if desired. The one-way repeat mode also includes a 1-second carrier "hang-time" (Tx carrier delay), as found on commercial repeaters!

- To enable one-way cross band repeat, hold RPT SET/ (REV) while turning on the power.
- Press BAND OFF/ to place **BAND** on the band you want the repeater Tx output to be on. Any signals received on the sub-band are automatically re-transmitted on the main band.

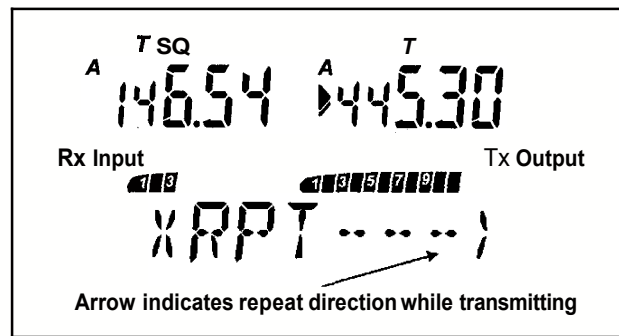

- ❑ For bi-directional cross band repeat, hold **RPT MNO** (6) while turning on the power.
- ❑ In this case you do not need to press **BAND OFF** (BAND) to select the main channel, as this changes depending on which channel the input signal is received on. The **▶** automatically switches to

show which channel the FT-51R is transmitting, or else you can glance at the **VHF/UHF** LEDs to see which is green/red, respectively.

- ❑ To exit the cross-band repeater mode, turn the transceiver off, repeat the appropriate power-on sequence.

One-way Repeat

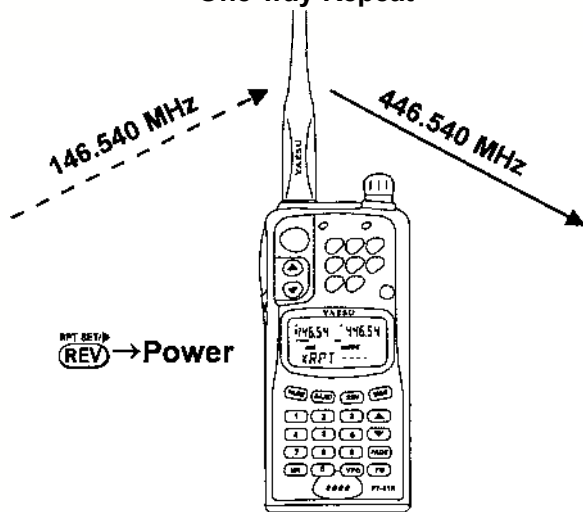

Main Channel: 446.540 MHz (Tx Output)
Sub Channel: 146.540 MHz (Rx Input)

Bi-Directional Repeat

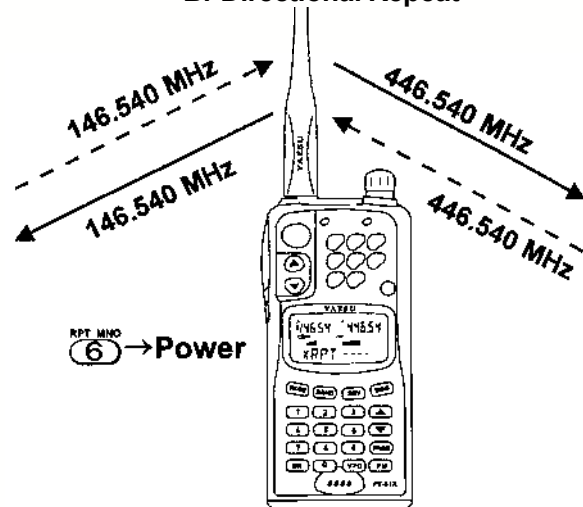

Main Channel: 446.540 MHz
Sub Channel: 146.540 MHz

Transceiver Cloning

You can transfer all data stored in one FT-51R to another set automatically by a cloning procedure. This requires a user-constructed cable to connect the **EAR** jacks on the two transceivers as shown below.

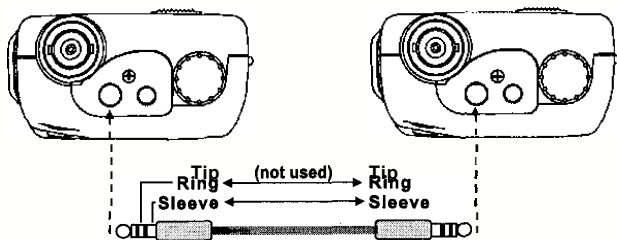

Construct a clone cable and insert into the **EAR** jacks as shown.

- Turn both units off, then press and hold the **GM** key of each radio while turning the power on again. The display appears as below.

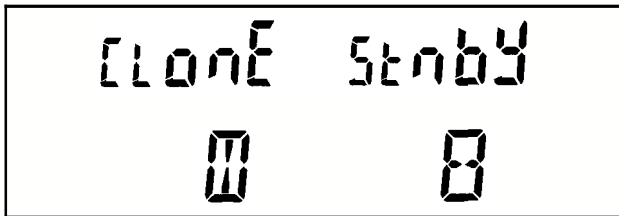

- Now insert the clone cable into the **EAR** jack of each transceiver, and press the **MHz B** key on the *destination* FT-51R.

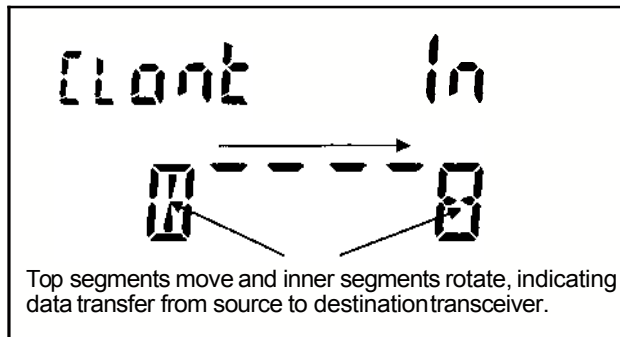

Top segments move and inner segments rotate, indicating data transfer from source to destination transceiver.

- Next press the **MHz A** key on the *source* FT-51R (the display shows **CLONE** **Init**).

After successful data transfer, the destination transceiver turns off automatically. If there was a problem, **CLONE Err** appears on the display, recheck your cable and then turn both transceivers off and try again.

- Remove the cloning cable. Channel and operating data for both transceivers are now identical.

Packet Radio Connections

To use the FT-51R for packet, the power saver should be disabled, since the sleep periods used in power saver operation can cause packets to be missed: press **(GM)** → **(4)** ^{SAVE GHI} and select **UFF**. *Note* – we do not recommend 9600 BPS data operation with the FT-51R and cannot guarantee through-put performance in this mode.

- Connect the **EAR** and **MIC** jacks to your TNC and FT-51R as shown below. MIC jack impedance is 2 k Ω , and maximum input is 300 mV_{rms}. **EAR** jack impedance is 8 ohms, and maximum output is 2 V_{RMS} (w/9.6-V supply).
- Refer to the documentation supplied with your TNC for final audio adjustments and operation.

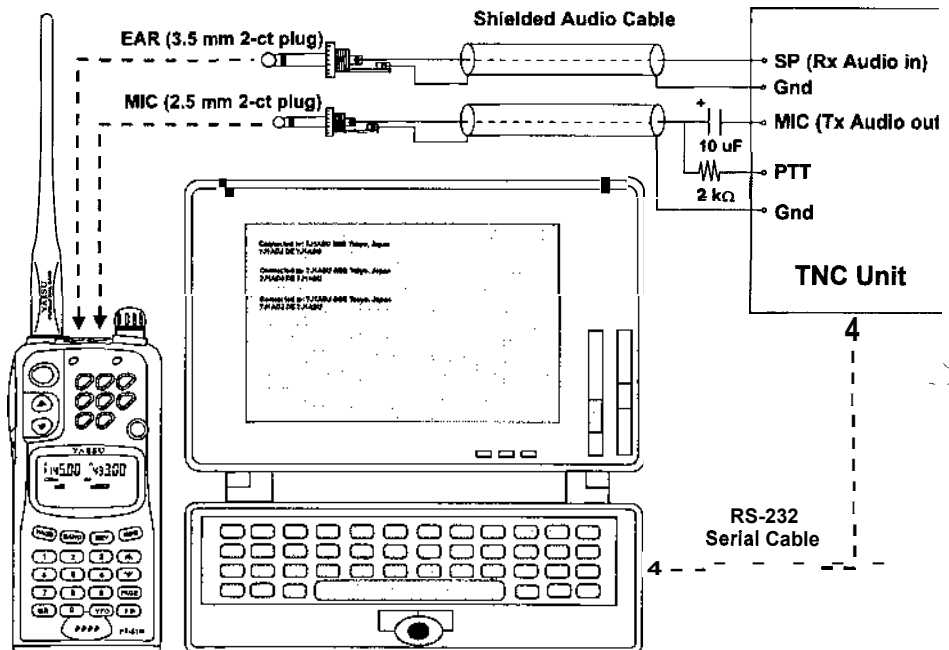

In Case of Problems

Don't worry if you find FT-51R operation somewhat complicated at first. You might find yourself temporarily lost, at least until you have had the chance to learn the various functions of the display and keys. This section provides some tips to help you navigate the various display and key modes if you get stuck.

If the display shows nothing at all, check the power switch, and if necessary, remove the battery pack and check that the contacts are clean. If all appears to be physically in order, recharge or replace the batteries.

The state of the display tells a lot about the current state of operation, and can take on many different states. Fortunately, the display includes many symbols and function indicators as well as the User Help prompts to let you know what is going on as long as power is applied, so it is well worthwhile to study the display diagram on page 8 carefully. For example, if two beeps sound unexpectedly when you transmit, check for a small "+" or "-" near the top center of the display, indicating that the operating frequency, with the selected repeater shift, is resulting in an out-of-band Tx frequency.

Invalid key entries usually do nothing, and no beep sounds. However, if the keys are locked, nothing happens when you press a key for even valid commands. Check for **KL** (key lock), **DL** (**DIAL** lock) or **PL** (**PTT** lock) in the display. If you see one of these, press the LOCK switch.

If you still cannot enter data, check to see if either of the VHF or UHF LEDs are red, indicating the transmitter is activated. Releasing the PTT switch should return the set to receive. If not, switch the transceiver off, and then back on.

If a **!** does not appear in the 100's-of-MHz digit place on the VHF band, or a **4** on the UHF band, or if the transceiver behaves strangely when you try to tune, check for either **PAGE**, **TPAGE** or **CODE** beneath the frequency display, indicating that DTMF Paging, Trigger Paging or Code Squelch is active with the code memory display option. If so, press **(PAGE)**^{CODE C}, several times if necessary, to clear these symbols and return the frequency display to normal.

To avoid confusion resulting from inadvertent button presses, set the keypad lock on as described on page 37 if you leave the transceiver unattended while it is on. Remember to set the lock back off when you wish to enter data.

Resetting the CPU

As a last resort, if you are unable to gain control of the transceiver, the FT-51R can be reset from the keypad to clear all settings, memories, channel step and repeater shifts to their factory defaults. Just press and hold the ^{SKIP}(MR), ^{PRI}(VFO) and ^{TSETABC}(2) together while turning the transceiver on.

Display Test

To check all LCD display indicators, segments and the VHF & UHF LEDs, turn the radio off, then hold the ^{SET}(O) key while turning the transceiver on. All display indicators, segments and LEDs remain on. Turn the radio off then on again to restore operation to as before.

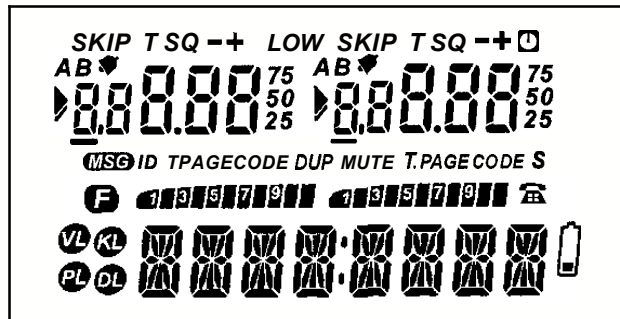

Display Test

FCC Warning (for USAusers)

This transceiver generates and utilizes radio frequency (RF) energy. Unapproved modifications performed on the circuitry of this equipment may cause harmful interference, and could result in damage to the transceiver.

With the exception of MARS (Military Affiliate Radio Service) and CAP (Civil Air Patrol) operators possessing valid authorization, transmit range modifications and the use of *amateur radio* (non-FCC type-accepted) equipment on frequencies outside of allocated amateur bands is *illegal!* This includes amateur operators who are members of public service (police, fire, rescue) agencies and also applies to marine band (VHF & HF) operation. Operators performing unauthorized modifications, possessing or operating modified equipment in this manner jeopardize losing privileges to operate this equipment and may be subject to fines and legal action in accordance with FCC rules and regulations.

In accordance with the Communications Privacy Act, intentional interception of Cellular Telephone frequencies (conversations) is prohibited.

YAESU

Performance without

YAESU MUSEN CO., LTD.

C.P.O. Box 1500, Tokyo, Japan

YAESU U.S.A.

17210 Edwards Rd., Cerritos, California 90703
U.S.A.

YAESU EUROPE B.V.

Snipweg 3. 1118DN Schiphol, The Netherlands

YAESU UK LTD.

Unit 2, Maple Grove Business Centre
Lawrence Rd., Hounslow, Middlesex TW4

UK

Copyright 1994
Yaesu Musen Co., Ltd.
All rights reserved.

No portion of this manual
may be reproduced without
the permission of
Yaesu Musen Co., Ltd.

E05117503(502c-DY)

