

YAESU
The radio

VHF/UHF
DUAL BAND FM TRANSCEIVER

FT-4XR
FT-4XE

Advance Manual



Clicking (tapping) at the  at the bottom left of the current browsing page, will return to the contents page at any time.

Contents

Communicating with specified other station	4
Selecting the Squelch Type	4
Tone squelch feature	5
Setting CTCSS Tone frequency	5
Digital Code Squelch (DCS) feature.....	6
Setting the DCS CODE.....	6
New Two CTCSS Tone Pager Function	7
Using the Pager Function	7
Setting the Code for Your Station.....	7
Calling a Specific Station	8
Receiving “pager code” calls from a Remote Station (Standby Operation).....	8
Using the Pager Answer Back	8
Notification of a Call from a Remote Station by the Bell Function ...	9
Convenient Functions.....	10
VOX Operation	10
VFO Split Mode	10
Split Memory.....	10
Using Memory Tag.....	11
Changing between name tag display and frequency display (Memory Tune).....	11
The Memory Channel Only Mode.....	12
Canceling Memory Only Mode.....	12
Using Memory Banks	13
Registering to Memory Banks.....	13
Memory Bank Recall.....	14
Returning To Memory mode from Memory Bank operation	14
Removing a Memory channel from a Memory Bank.....	14

Contents





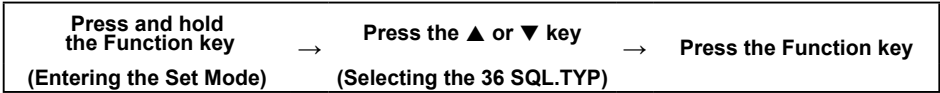

How to Skip (Omit) a Channel during Memory Scan Operation ...	14
Programmable Memory Channel Scan (PMS)	15
Registering to the Programmable Memory Channels	15
Performing Programmable Memory Channel Scan	15
Dual Receive (DW) Function	16
Activating the Dual Receive (DW) feature	16
Priority Revert Mode	17
ARTS (Automatic Range Transponder System).....	18
Basic ARTS Setup and Operation.....	18
ARTS Polling Time Options	19
ARTS Alert Beep Options	19
CW Identifier Setup.....	19
DTMF Operation.....	20
Setting the DTMF Memory.....	20
Transmitting the Registered DTMF Code	21
Manually Transmitting the DTMF Code	21
Customizing Menu Settings and User Preferences (Set Mode)...	22
Setting the Set Mode	22
Tables of Set Mode Operations	23
Cloning	33
Troubleshooting.....	34

Communicating with specified other station

Selecting the Squelch Type



1. Press the [▲] or [▼] key to select one of the modes described below.

Squelch type	Icon indication	Description
OFF (default)	-	Deactivates the tone squelch function and DCS function OFF, then returns to the normal squelch operation.
R-TONE	 (appears)	Enables receive only tone squelch function.
T-TONE	 (appears)	Enables transmit only tone squelch function.
TSQL	 (appears)	Enables the tone squelch receive function.
REV TN	 (blinks)	Enables the reverse tone squelch function. Use to monitor communications based on the squelch control system in which a received signal containing the selected tone will be muted, and signals not containing the selected tone will be heard.
DCS	 (appears)	Enables the digital code squelch function. The DCS code may be selected from 104 codes (from 023 to 754).
PAGER	 (appears)	Activates a new two-tone CTCSS pager function. When communicating via transceivers with your friends, specify personal codes (each code is composed of two tones) so that you can call only specific stations.

2. Press the PTT switch to save the new setting and return to normal operation.



- The squelch type may be set for each frequency band (BAND).
- The CTCSS and DCS squelch settings are also active during scanning. If scanning is performed with the CTCSS and DCS squelch function activated, scanning stops only when a signal containing the specified CTCSS tone or DCS code is received.
- Pressing the **MONI/T-CALL** switch allows signals that do not contain a tone or DCS code, and signals with different tones, DCS codes to all be heard.

Tone squelch feature

The tone squelch opens the speaker audio only when a signal containing the specified CTCSS tone is received. The receiver will be quiet while waiting for a call from a specific station.

Setting CTCSS Tone frequency

The tone frequency may be selected from 50 frequencies (from 67.0 Hz to 254.1 Hz).

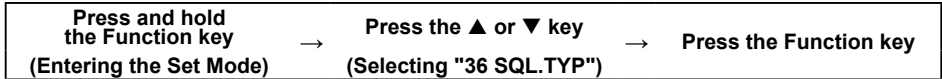

1. Press the [▲] or [▼] to select the "TSQL"
2. Press the Function key.

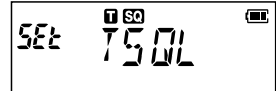

3. Press the [▲] or [▼] to select the "38 TN FRQ".
4. Press the Function key.
 - The receive (R) tone frequency setting screen will appear.
5. Press the [▲] or [▼] to select the receive (R) tone frequency.

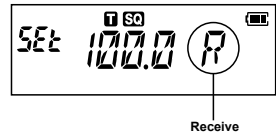

- Pressing the [*V/M] key to switch to the transmit (T) tone frequency, then press the [▲] or [▼] to select the transmit (T) tone frequency.
6. Press the PTT switch to save the settings and return to normal operation.



- The tone frequency setting is common with the squelch types as follows:
R-TONE, T-TONE, TSQL, RV TN
- The default setting is "100.0Hz".

Digital Code Squelch (DCS) feature

The Digital Code Squelch opens the speaker audio only when a signal containing the specified DCS code is received.

The DCS code may be selected from 104 types (from 023 to 754).

Setting the DCS CODE

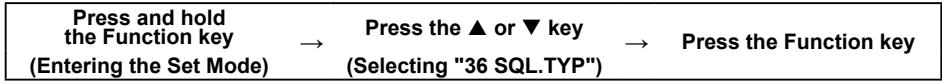

1. Press the [▲] or [▼] to select the "DCS"
2. Press the Function key.



3. Press the [▲] or [▼] to select the "10 DCS.COD".
4. Press the Function key.
 - The receive (R) DCS code setting screen will appear.
5. Press the [▲] or [▼] to select the receive (R) DCS code.
 - Pressing the [*V/M] key to switch to the transmit (T) DCS code, then press the [▲] or [▼] to select the transmit (T) DCS code.

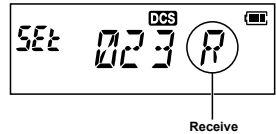

6. Press the **PTT** switch to save the settings and return to normal operation.



The default DCS code is "023".

New Two CTCSS Tone Pager Function

When using the FT-4XR/XE transceivers with a group of friends, setting the two CTCSS tone personal codes allows calling just the specific stations.

Using the Pager Function

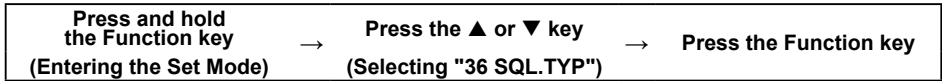

1. Press the [▲] or [▼] to select the "PAGER".



2. Press the PTT switch to save the setting and return to the normal operation.

- The new pager function is activated.

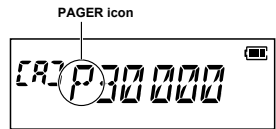

Setting the Code for Your Station

Set the "pager code" to be called by other stations.

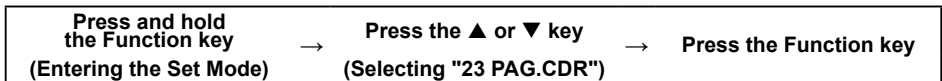

1. Press the numeric key to input the first element of the code from 01 to 50.

- The icon is moved to the second element of the code.

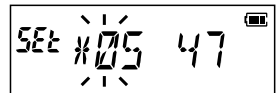

2. Press the numeric key to input the second element of the code from 01 to 50.

- The first and second element of the code may not be set to the same code.
- Press the [▲] or [▼] to switch the icon between first code and second code.

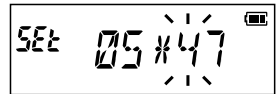

3. Press the PTT switch to save the setting and return to normal operation.

- The reverse combination works as the same code, that is "05 47" is the same as "47 05".
- If the same code is specified for all individuals, all the individuals can be called at the same time.
- The default code is "05 47".
- When receiving the signals, the intermittent sound of the tone signal may be heard slightly.



Calling a Specific Station

The “pager code” may be set to call to specific stations.

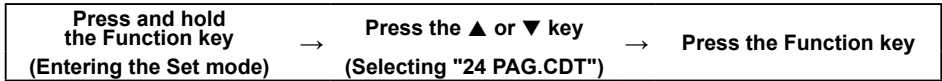

1. Press the numeric key to input the first element of the code from 01 to 50.
 - The icon is moved to the second element of the code.
2. Press the numeric key to input the second element of the code from 01 to 50.
 - The first and second element of the code may not be set to the same code.
 - Press the [▲] or [▼] to switch the icon between first code and second code.
3. Press the **PTT** switch to save the setting and return to normal operation.
4. Press the **PTT** switch to transmit a call to the specific station.

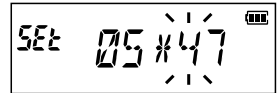
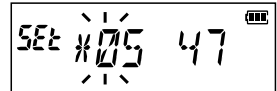

Receiving “pager code” calls from a Remote Station (Standby Operation)

When the Pager function is activated, and a call is received with a corresponding Code, “PAGING” blinks and the audio is heard.

Furthermore, when the Bell function (☐9) is activated, the bell rings and the 📞 icon blinks while calling from the other station.

Using the Pager Answer Back

If the Answer Back feature is ON, when called by another station with a corresponding pager code, the transceiver is automatically placed in the transmit mode (for about 2.5 seconds) to notify the other station that you are ready to communicate.

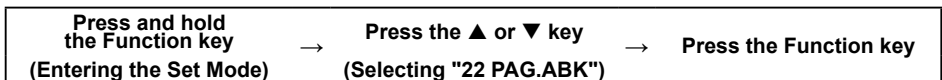

1. Press the [▲] or [▼] to select the “ABK.ON”.

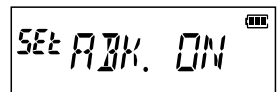

2. Press the **PTT** switch to save the setting and return to normal operation.

Notification of a Call from a Remote Station by the Bell Function

The Bell may be set to sound an Alert when a call from another station containing a corresponding tone, DCS or pager code is received. "🔔" icon on the LCD blinks while the sound alerts.

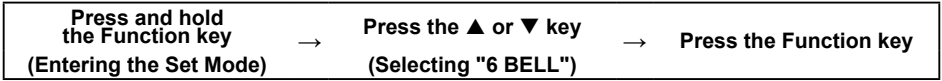

1. Press the [▲] or [▼] to select the desired number of times (1-8 times or continuous) the Bell rings.

••• ⇄ **OFF** ⇄ **1T** ⇄ **3T** ⇄

⇄ **5T** ⇄ **8T** ⇄ **CONT** (continuous) ⇄ •••

2. Press the **PTT** switch to save the setting and return to normal operation.

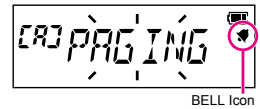

Example of New PAGER function



- The default setting is "OFF".
- If setting the "CONT" (continuous), the bell keeps sounding until operating something.
- If "OFF" is set in the Set Mode "5 BEEP", the bell does not sound.

Convenient Functions

VOX Operation

The VOX (Voice Over Transmit) system provides automatic transmit/receive switching based on voice input without pressing the PTT switch in order to transmit. The optional SSM-512B VOX Earpiece Microphone is supported.

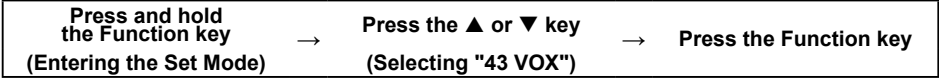

1. Press the [▲] key or [▼] key to select the "VOX ON".
2. Press the **PTT** switch to save the setting and return to normal operation.
 - When the VOX system is activated, the "V" icon will appear on the display.

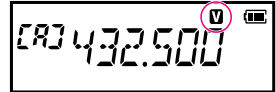

Connecting to the SSM-512B VOX Earpiece Microphone, refer to the supplied SSM-512B manual sheet.

VFO Split Mode

Two different frequencies, one for receive (VFO-A) and another for transmit (VFO-B), may be transmitted and received (or vice versa).

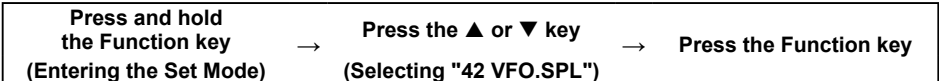

1. Press the [▲] or [▼] to select the "VSP. ON".
2. Press the **PTT** switch to save the setting and return to normal operation.
3. Set VFO-A for the desired receiving (downlink) frequency.
4. Press the [*V/M] key to set VFO-B for desired transmit (uplink) frequency.
5. Press the [*V/M] key twice to re-establish VFO-A as the "Main" (receive) VFO.
6. When the **PTT** switch is pressed to transmit, VFO-A and VFO-B will reverse positions. Releasing the **PTT** switch, the reverse position is canceled.

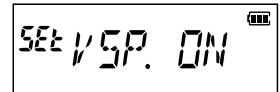

Split Memory

Two different frequencies, one for receive and another for transmit, may be registered to a memory channel.

1. Register the receive frequency to a memory channel first.
See "Registering to Memory Channels" (Operating Manual).
2. Set the transceiver to the desired transmit frequency.
3. Press and hold the [*V/M] key.
 - A blank memory channel will be displayed automatically.

4. Press the [▲] key or [▼] key to select the memory channel number registered in step 1.
5. Press the [P2] key.
 - The beep sounds, Split memory channel is registered.
 - While recalling the Split memory channel, “-” and “+” will appear.
6. Press the PTT switch to save the setting and return to normal operation.

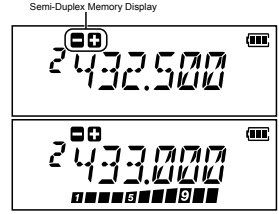

While operating the Split Memory, press the Function key, then press the [P2] key to reverse the transmit and receive frequencies temporarily. When reversing the frequencies, “-” and “+” blink.

Using Memory Tag

Memory name tags (up to 6 characters) may be assigned or changed on the memory channels or PMS memory channel.

1. Press the [*V/M] key to recall the memory channel to assign the name tag.
2. Press and hold the function key, then press the [▲] key or [▼] key to select the Set Mode “21 MEM.TAG”.
3. Press the Function key.
The character input screen is displayed.
4. Use the numeric key to input the characters.
 - Inputting characters
Example quickly Pressing the [2] key, each time switches the following characters:
2 → A → B → C → a → b → c → 2 → ...
 - Moving the cursor
[▲] key: Moves the cursor to the right
[▼] key: Moves the cursor to the left
5. Press and hold the Function key.
 - The memory tag is registered to the Memory Channel and return to upper Set Mode item.
6. Press the PTT switch to return to the Memory Channel mode.



The memory name tag registered to the channel is automatically displayed as the memory tag indication.

Changing between name tag display and frequency display (Memory Tune)

The memory tag display may change the frequency display temporarily and tune off temporarily (Memory Tune).

1. Recall the Memory channel to be changed.
2. Press the [#BAND] key.
“tun” will appear and the [#BAND] key will toggle between the Memory tag and the frequency display. During the frequency display, Press the [▲] key or [▼] key to tune to the desired frequency.

The Memory Channel Only Mode

The **FT-4XR/XE** may be set to operated only in the registered memory channels.

1. Press and hold the **MONI/T.CALL** key and the **PTT** switch simultaneously, while turning the transceiver **ON**.
2. Press the [**▲**] or [**▼**] key to select the “**F5 M-ONLY**”.
3. Press the Function key.
 - The memory channel only mode is ON, the previously selected memory channel is recalled.
 - Pressing the [**▲**] or [**▼**] key may be selected the memory channel.
 - Inputting the 3 digits of the memory channel using the numeric keys may be recalled the memory channel directly.



-
- In the memory only mode, the following functions will not operate:
 - Changing the VFO mode (Press the [***V/M**] key)
 - Memory Tune (Press the [**#BAND**] key)
 - Program Memory scan (Press the Function key, and then press the [**#BAND**] key)
 - Recalling the Home channel
 - Reverse function (Press the Function key, and then press [**P2**] key)
 - DTMF autodialer setting
 - In the memory only mode, press the Function key to change the squelch level.
 - In the memory only mode, press and hold the Function key to change the transmit output level.
-

Canceling Memory Only Mode

1. Turn the transceiver **OFF**, and then press and hold the **MONI/T.CALL** key and the **PTT** switch simultaneously to, while turning the transceiver **ON** again. The memory channel only mode **OFF**.

Using Memory Banks

The transceiver allows using up to 10 memory banks to be recalled with the sorted the memory channels. One memory channel may also be registered in two or more memory banks according to the intended use.

Example of registering memory channels to the memory banks:

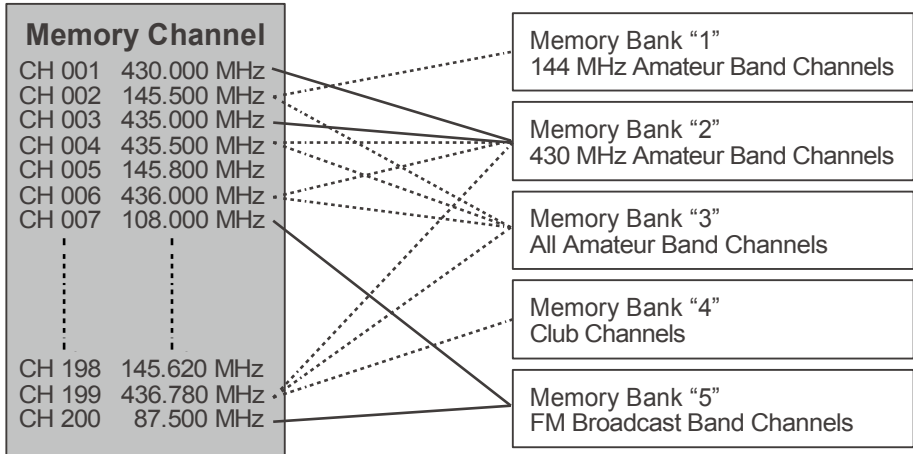

Registering to Memory Banks

1. Press the **[*V/M]** key to enter the memory mode.
2. Press the **[▲]** or **[▼]** key to recall the memory channel to register in the memory bank.

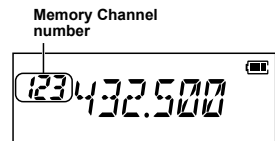

3. Press and hold the **[#BAND]** key.
"SEL" blinks.
4. Press the **[▲]** or **[▼]** key to select the the memory bank (BANK 1 to BANK 10) to register the memory channel.
 - Blinking Bank number is assignable.

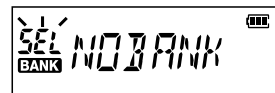

5. Press and hold the Function key.
The memory channel is registered to the Memory Bank and the blinking Bank Number stops blinking.

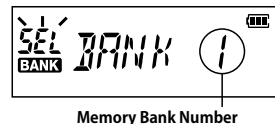

6. Press the **PTT** switch to return to the memory channel.

Memory Bank Recall

1. Press the [***V/M**] key to enter the Memory Mode.
2. Press and hold the [**#BAND**] key, then press the [**▲**] or [**▼**] key to select the desired Memory Bank (“BANK 1” through “BANK10”).
3. Press the [***V/M**] key.
 - Only memory channels assigned in the current memory Bank will be available.
 - When the multiple memory channels are assigned in one memory bank, press the [**▲**] or [**▼**] key to select the desired memory channel.
 - The “**BANK**” indication will appear at the left side of the frequency display while operating within a Memory Bank.
 - The memory channel number appears above the “**BANK**” icon.
 - To change to another Memory Bank, press and hold the [**#BAND**] key.



Returning To Memory mode from Memory Bank operation

1. While in the Memory Bank Mode, press and hold the [**#BAND**] key, and then press the [**▲**] or [**▼**] key to select “NO BANK”.
2. Press the [***V/M**] key to return to Memory Mode.

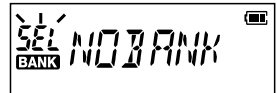

Removing a Memory channel from a Memory Bank

1. Recall the Memory Bank that contains the memory channel to delete.
2. Press the [**▲**] or [**▼**] key to select the Memory channel to delete, then press and hold the [**#BAND**] key.
3. Press and hold the Function key to remove the memory channel.
 - If assigned memory channels still remain in the Memory Bank, the display will return to a Memory Bank channel.
 - If there is no assigned memory channel in the Memory Bank, the display will return to the Memory mode.

How to Skip (Omit) a Channel during Memory Scan Operation

The “Skip Memory Channel” may be skipped during the memory scanning. When the “Skip Memory Channels” is set, the specified memory channels may be skipped during the memory scanning.

1. Recall the memory channel to specify.
2. Press and hold the Function key, then press the [**▲**] or [**▼**] key to select Set Mode “**35 SKIP**”.
3. Press the Function key.
4. Press the [**▲**] or [**▼**] to select the “**SKIP**”

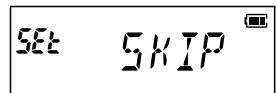

5. Press the **PTT** switch to return to normal operation.
 - The “▶” icon will appear above the memory channel number, indicating it is to be ignored during scanning.

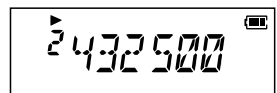

Programmable Memory Channel Scan (PMS)

Registering to the Programmable Memory Channels

10 sets of PMS memory channels (L01/U01 to L10/U10) are available.

Register the lower and upper frequencies of the frequency range in a pair of Programmable Memory Channels,

L□□: Lower limit memory channel

U□□: Upper limit memory channel

For more details on registering frequencies to the memory channel, see the operating manual.

- Make sure to use the corresponding numbers for the lower and upper limit memory channels.
- Set the PMS memory channel for performing the Programmable Memory scanning (PMS) as follows.



- The scan width of the upper and lower limit frequencies must be 100 kHz or more.
- The lower and upper limit memory channels must be within the same frequency band.
- The lower and upper limit memory channels must not register the lower and upper channels in reverse.

Performing Programmable Memory Channel Scan

The programmable memory channel scan allows scanning a specified frequency range within the same frequency band.

1. Press and hold the **[#BAND]** key.
2. Press the **[▲]** or **[▼]** key to select the “PMS-□”.
 - “PMS-□” will change depending on the currently-selected PMS frequency pair.
3. Press the **PTT** switch to return to normal operation.
4. Press the Function key, then press the **[#BAND]** key.

The scanning starts just within the programmed range.

 - During scanning, “P-□” appears on the upper left side of the LCD.
 - If the scanner halts on an incoming signal, the back light will turn ON and the decimal point between the “MHz” and “kHz” digits of the frequency display will blink.

Scanning will resume in about two seconds.
5. Press the **PTT** switch to cancel the scanning.

Dual Receive (DW) Function

The transceiver is equipped with the following 3 types of Dual Receive Functions:

- VFO Dual Receive
- Memory Channel Dual Receive
- Home Channel Dual Receive

The transceiver checks for signals on the frequency registered to the selected memory channel (Priority Memory Channel) once approximately every 5 seconds. When receiving a signal on the frequency registered to a priority memory channel, the Dual Receive function temporarily pauses, and allows reception of the signals.

Example: Checking the priority memory channel “1” (145.000 MHz), while receiving “432.500 MHz”.

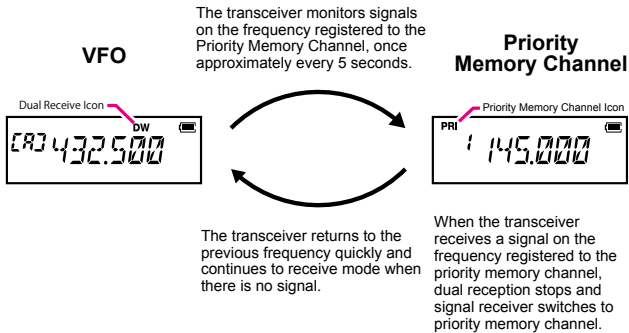

Activating the Dual Receive (DW) feature

1. Press the [***V/M**] key to set the memory channel “1” (the Priority Memory Channel) to receive.
2. Set the frequency and communication mode to monitor continually.
 - The monitor frequency may be set on the VFO mode, the memory channel mode or the HOME channel mode.

VFO Dual Receive

VFO ⇄ Priority Memory Channel

Memory Channel Dual Receive

Memory Channel ⇄ Priority Memory Channel

HOME Channel Dual Receive

HOME Channel ⇄ Priority Memory Channel



When using the Memory Channel Dual Receive, register the Priority memory channel to the Memory channel number “1”. the Memory Bank feature also checks the Memory channel number “1”.

3. Press the Function key, then press the [***V/M**] key.
 - “DW” icon appears and the Dual Receive function activates.
4. Press the [***V/M**] key to cancel the Dual Receive function.

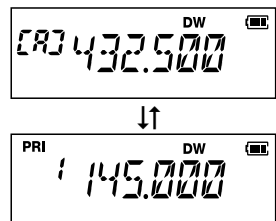

Priority Revert Mode

During the Memory Channel Dual Receive operation, press the PTT switch to transmit the specified priority memory channel.

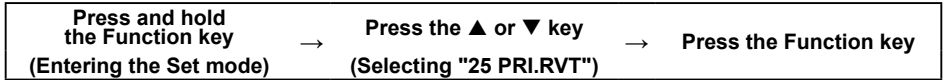

1. Press the [▲] or [▼] key to select "RVT ON".

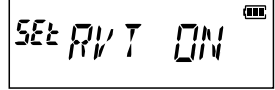

2. Press the **PTT** switch to save the setting and return to the normal operation.

ARTS (Automatic Range Transponder System)

The ARTS feature uses DCS signaling to inform both parties when another ARTS equipped station is within communications range. This may be particularly useful during Search and Rescue situations, where it is important to stay in contact with the other members of the group.

The stations must set up their DCS codes to the same code number, and then activate their ARTS feature using the command appropriate for their transceiver. Alert ringers may be activated, if desired.

Whenever the **PTT** switch is pressed, or every 15 or 25 seconds after ARTS is activated, the transceiver will transmit a signal which includes a (subaudible) DCS code for about one second. If another ARTS enabled transceiver is in range, the beeper will sound and the display will show **"IN.RNG"**. When the other transceiver is out of range, **"OUT.RNG"** is shown when the ARTS function is in operation.

Whether or not the **PTT** switch is pressed, the transceiver may be programmed to transmit a CW ID, every 10 minutes.

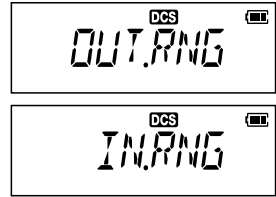

If you move out of range for more than one minute (four pollings), the transceiver will sense that no signal has been received, three beeps will sound, and the display will revert to **"OUT.RNG"**. If you move back into range, the transceiver will again beep, and the display will change back to the **"IN.RNG"** indication.

During ARTS operation, it is not possible to change the operating frequency or other settings. In order to resume normal operation, ARTS must be terminated. This is a safety feature designed to prevent accidental loss of contact due to channel change, etc.

Basic ARTS Setup and Operation

1. Set all the transceivers to the same DCS code number, per the instructions on page 6.
2. Press and hold the [2] key.
 - ARTS polling will start.
 - **"OUT.RNG"** will be displayed on the LCD.
3. Every 25 seconds, the transceiver will transmit a "polling" call to the other station.
 - When that station responds with its own ARTS polling signal, the display will change to **"IN.RNG"** to confirm that the other station's polling code response was received.

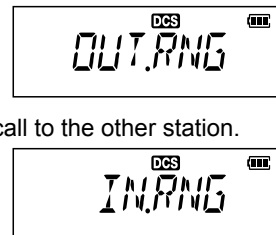

- Press the Function key (or press and hold the [2] key) to exit ARTS operation and resume normal transceiver operation.

ARTS Polling Time Options

The ARTS feature may be programmed to poll every 25 seconds (default setting) or 15 seconds. The default setting provides maximum battery conservation, because the polling signal is sent out less frequently.

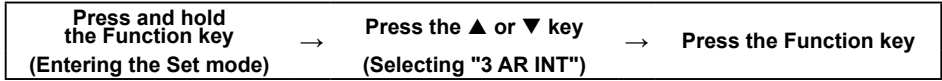

- Press the [▲] or [▼] key to select the desired polling interval (15 or 25 seconds).

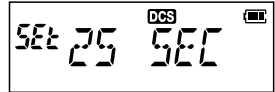

- Press the PTT switch to save the new setting and return to normal operation.

ARTS Alert Beep Options

The ARTS feature permits two types of alert beeps (or may be turned off).

Display	Description
OFF(Default setting)	No beeps.
INRANG	Beeps sound only when the transceiver first confirms a station is within range, but does not re-confirm with beeps thereafter. Display is the same function as "OFF".
ALWAYS	Each time a polling transmission is received from the other station, the alert beeps will sound. Display is same function as "OFF".

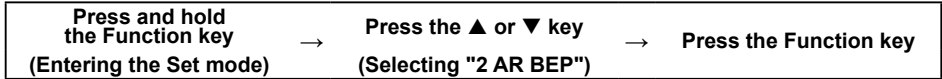

- Press the [▲] or [▼] key to select the above type.

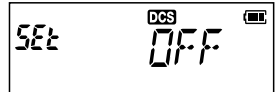

- Press the PTT switch to save the new setting and return to normal operation.

CW Identifier Setup

The transceiver may be programmed to send a CW identification (e.g. call sign) every ten minutes during ARTS operation. The call sign field may contain up to 6 characters.

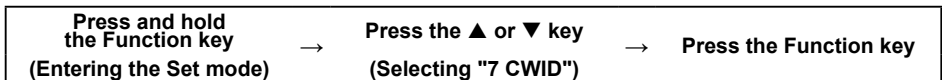

- Press the [▲] or [▼] key to select "TX ON".
- Press the Function key, then press the [▲] or [▼] key to select "8 CW WRT".

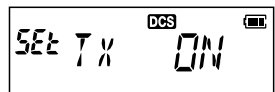

- Press the Function key twice, the cursor blinks to input the call sign.

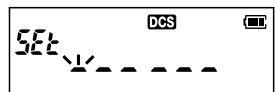

- Press the Alphabet/Numeric keys to input the call sign.

- After inputting a character of the call sign, press the [▲] key to move the cursor to the next character position.
- To correct a mistake, press the [▼] key repeatedly until the cursor returns to the character position.



To check the work by monitoring the call sign, press the **MONI/T.CALL** key.

5. When you have finished entering the entire call sign and it contains less than 6 characters, press and hold the Function key to save the call sign.
6. Press the **PTT** switch to save the new setting and return to normal operation.

DTMF Operation

DTMF (Dual Tone Multi Frequencies) are the tone signals sent to make telephone calls, or control repeaters. Up to 10 registers of 16-digit DTMF tone codes can be stored as telephone numbers to make calls through the public telephone network using a phone patch.

Setting the DTMF Memory

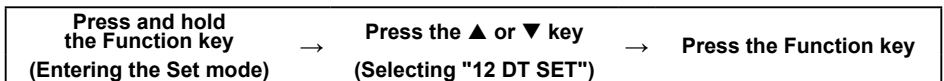

- The DTMF memory channel number blinks.



1. Press the [▲] or [▼] key to select DTMF memory channel number to register.
2. Press the Function key.
The DTMF memory channel input screen is displayed.

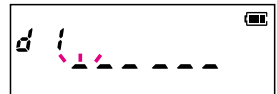

3. Use the numeric keypad or the [▲] or [▼] key to input the DTMF code maximum of 16 digits.
 - The numeric key:
The DTMF codes from 0 to 9 may be input directly.
 - The [▲] or [▼] key
The following DTMF codes may be selected.
... ↔ **0 to 9** ↔ **A to F** ↔ ...
"*" is displayed as "E", "#" is displayed as "F".
 - The Function key
The selected code is entered, the cursor moves to next code.
To correct a mistake, press the Function key repeatedly (or press and hold the Function key and then press the Function key again) until the cursor returns to the first code position and then begin the DTMF Memory entry again.
4. When finishing inputing, press and hold the Function key to save the DTMF code.
5. Press the **PTT** switch to save the new setting and return to normal operation.

Transmitting the Registered DTMF Code

1. Press the Function key, then press the [9] key to toggle between the "AUTO" and "MANUAL". Select the "AUTO".

AUTO

Display	Description
AUTO	The registered DTMF code is automatically transmitted.
MANUAL	The DTMF code may be transmitted manually by pressing each numeric key.

2. While pressing the PTT switch, press a numeric [1] to [9] key to DTMF memory number registered in "Setting the DTMF Memory".
 - The DTMF code registered in the DTMF memory channel is automatically transmitted.
 - Even after releasing the PTT switch, the transmission continues until the DTMF code is completed. The transceiver is automatically returned to receive mode.

Manually Transmitting the DTMF Code

1. Set "MANUAL" referring to the above "Transmitting the Registered DTMF Code".

MANUAL

2. While pressing and holding the PTT switch to transmit, press each corresponding key to send the DTMF code:

[0] to [9] key: 0 to 9

[▲] key: A

[▼] key: B

[P1] key: C

[P2] key: D

[*V/M] key: *

[#BAND] key: #

The transmission may continue for two seconds after releasing the PTT switch.

Customizing Menu Settings and User Preferences (Set Mode)

From the Setup menu, the various functions of the transceiver may be customized according to the user's personal preferences. Setting or inputting in each Set Mode item allows more easy to use.

Setting the Set Mode

1. Press and hold the Function key.
The previously selected Set Mode item is displayed.



2. Press the [▲] or [▼] key to select to the desired Set Mode item.
3. Press the Function key, then press the [▲] or [▼] key to change the setting.
4. Press the **PTT** switch to save the new setting and return to normal operation.
 - On some setting screens, pressing the **PTT** switch does not exit from Set mode. In this case, press and hold the Function key to return to the upper menu in the Set Mode, then press the **PTT** switch to return to normal operation.

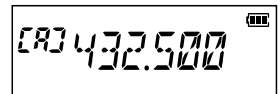
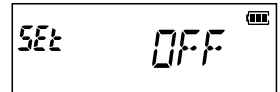
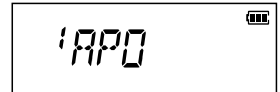

- In step 4 above, press the Function key to save the new setting and return to Set Mode item in step 2. This is convenient for setting another Set Mode item.
- On some setting screens, the key operation is different than described in the above steps (For example, inputting the characters, etc.). Refer to the “**Tables of Set Mode Operations**”.

Tables of Set Mode Operations

No.	Set Mode item	Description	Selectable options (Options in bold are the default settings)
1	APO	Sets the length of time until the transceiver turns off automatically.	OFF / 0.5 Hours – 12Hours
2	AR BEP	Sets the beep option during ARTS operation.	OFF / INRANG / ALWAYS
3	AR INT	Sets the polling interval during ARTS operation.	25 SEC / 15 SEC
4	BCLO	Turns the busy channel lockout function ON/OFF.	BCL.OFF / BCL.ON
5	BEEP	Sets the beep function on pressing the keypad, or stopping the receiver scanning.	KEY+SC / KEY / OFF
6	BELL	Selects the number of CTCSS/DCS/PAGER/ARTS Bell ringer repetitions.	OFF / 1 T / 3 T / 5 T / 8 T / CONT
7	CWID	Turns the CW Identifier ON/OFF during ARTS operation.	TX OFF / TX ON
8	CW WRT	Sets the CW ID during ARTS operation.	ID= - - - - - (6 characters) default: blank
9	DC VLT	Displays the voltage.	(Voltage)
10	DCS.COD	Sets the DCS CODE RX and TX.	104 DCS CODEs / OFF default: 023 R / 023 T
11	DT DLY	Sets the DTMF code transmission delay time.	50MS / 250MS / 450MS / 750MS / 1000MS
12	DT SET	Selects the DTMF auto dialer memory channel and edits the DTMF code (Maximum 16 digits)	d1 – d9
13	DT SPD	Sets the DTMF code transmission speed.	50MS / 100MS
14	EDG.BEP	Turns the the Band-edge beeper on/off while selecting the frequency via the [▲] or [▼] key.	BEP.OFF / BEP. ON
15	LAMP	Selects the LCD/Keypad Lamp mode.	5 SEC / 10 SEC / 30 SEC / CONT / OFF
16	LED.BSY	Turns the TX/BUSY lamp ON/OFF while receiving signals.	BSY ON / BSYOFF
17	LED.TX	Turns the TX/BUSY lamp ON/OFF while transmitting signals.	TX ON / TXOFF
18	LOCK	Configures the lock mode setting.	LK KEY / LK PTT / LK P+K
19	M/T-CL	Selects the function of the MONI/T-CALL switch.	MONI / TC1750* / TC2100 / TC1000 / TC1450 (*: European version)
20	MEM.DEL	Deletes the memory channel	-
21	MEM.TAG	Edits the memory channel tag.	-
22	PAG.ABK	Turns the pager answer back Function ON/OFF	ABK.OFF / ABK. ON
23	PAG.CDR	Specifies a personal code (receive).	01 – 05 – 50, 01 – 47 – 50
24	PAG.CDT	Specifies a personal code (transmit).	01 – 05 – 50, 01 – 47 – 50
25	PRI.RVT	Turns the Priority Revert feature ON/OFF.	RVTOFF / RVT ON
26	PSWD	Turns the Password feature ON/OFF.	PWD.OFF / PWD. ON

27	PSWDWT	Inputs the password.	(4 digits)
28	RF SQL	Adjusts the RF Squelch threshold level.	OFF / S-1 / S-2 / S-3 / S-4 / S-5 / S-6 / S-8 / S-FULL
29	RPT.ARS	Turns the ARS function on/off.	ARS.ON / ARS.OFF
30	RPT.FRQ	Sets the repeater shift width.	OFF / 0.025MHz – 99.975MHz
31	RPT.SFT	Sets the repeater shift direction.	SIMPLX / +RPT / -RPT
32	RXSAVE	Selects the Receivemode Battery Saver interval (“sleep” ratio)	200 MS - 2 SEC / OFF
33	SCN.LMP	Turns the scan lamp ON/OFF while paused.	ON / OFF
34	SCN.RSM	Configures the scan stop mode settings.	BUSY / HOLD / TIME
35	SKIP	Turns the Memory Scan “Skip” channel selection mode ON/OFF.	OFF / SKIP
36	SQL.TYP	Selects the Tone Encoder and/or Decoder mode.	OFF / R-TONE / T-TONE / TSQ L / REV TN / DCS / PAGER
37	STEP	Sets the frequency steps.	AUTO / 5.0 / 6.25* / 10.0 / 12.5 / 15.0 / 20.0 / 25.0 / 50.0 / 100.0 k (*: European version only)
38	TN FRQ	Sets the TONE frequency.	OFF / 67.0 R – 100.0 R – 254.1 R OFF / 67.0 T – 100.0 T – 254.1 T
39	TOT	Sets the timeout timer.	OFF / 1MIN – 3MIN – 30MIN
40	TX PWR	Selects Transmitter Power	HIGH (5W) / MID (2.5W) / LOW (0.5W)
41	TX SAVE	Turns the Transmitter Battery Saver ON/OFF.	SAVOFF / SAV ON
42	VFO.SPL	Turns the “VFO Split” operation ON/OFF.	VSP.OFF / VSP. ON
43	VOX	Turns the VOX function ON/OFF.	VOXOFF / VOX ON
44	WFM.RCV	Broadband FM Transceiver(WFM) function Enables/Disables.	WFM.ON / WFM.OFF
45	W/N.DEV	Sets the Transmit Modulation Level in the FM mode.	WIDE / NARROW
46	WX ALT	Turns the Weather Alert Scan ON/OFF.	ALT.OFF / ALT. ON

1 APO

Set the length of time until the transceiver turns off automatically.

OFF	Automatic Power OFF (APO)
0.5 H – 12 H (Hours)	“ O ” icon appears on the LCD; the transceiver is turned OFF automatically when no operation is performed for a specified period of time. Beep sounds about 60 seconds before turn OFF.

2 AR BEP

Selects the beep option during ARTS operation.

OFF	No alert beeps sound.
INRANG	Beeps sound only when the transceiver first detects that you are within range.
ALWAYS	Beeps sound every time a polling transmission is received from the other station (every 15 or 25 seconds when in range).

For more details, see “ARTS Alert Beep Options”

3 AR INT

Selects the Polling Interval during ARTS operation.

25 SEC	25 seconds Polling interval
15 SEC	15 seconds Polling interval

For more details, see “ARTS Polling Time Options”

4 BCLO

Enables/Disables the Busy Channel Lock-Out feature.

Preventing transmissions when the receive channel is busy.

BCL.OFF	Permits starting a transmission while receiving a signal.
BCL.ON	Disables transmissions while receiving a signal.

5 BEEP

Sets the beep function on pressing the keypad, or stopping the receiver scanning.

KEY+SC	The beeper sounds when you press any key, or when the scanner stops.
KEY	The beeper sounds when you press any key.
OFF	Beeper is disabled.

6 BELL

Selects the number of CTCSS/DCS/PAGER/ARTS Bell ringer repetitions.

OFF	The beeper does not sound.
1 T – 8 T	The number of times the bell rings may be set from among 1 to 8 times.
CONT	The bell continues to sound until performing key.

7 CWID

Turns the CW Identifier ON/OFF during ARTS operation.

TX OFF	The CW ID does not transmit.
TX ON	The CW ID transmits.

8 CW WRT

Programs and activates the CW Identifier (used during ARTS operation).

See “CW Identifier Setup” for details.

9 DC VLT

Displays battery DC voltage.

10 DCS.COD

Sets the DCS CODE RX and TX.

104 standard DCS codes are available. Default setting is 023 R (receive) / 023 T (Transmit).

See “Setting the DCS CODE” for details.

11 DT DLY

Sets the DTMF code transmission delay time.

Set the transmission delay time of the registered DTMF code when set “AUTO”.

50MS / 250MS / 450MS / 750MS / 1000MS (msec)	While pressing and holding the PTT switch, press the numeric key, set the registered DTMF code delay time.
-----------------------------------------------------------	------------------------------------------------------------------------------------------------------------

12 DT SET

Select and edit the DTMF auto dialer memory channel.

Up to 9 registers of 16-digit DTMF tone codes may be stored.

For more details, see “DTMF Operation”.

13 DT SPD

Set the DTMF Autodialer Sending Speed.

50MS	High speed
100MS	Low speed

14 EDG.BEP

Turns the the Band-edge beeper on/off. while selecting the frequency via the [▲] or [▼] key.

BEP.OFF	Band-edge beeper OFF
BEP. ON	Band-edge beeper ON

15 LAMP

Selects the LCD/Keypad Lamp mode.

OFF	The LCD and keypad do not light up.
5 SEC - 10 SEC - 30 SEC	When the key is pressed, the LCD and key lights remain illuminated for the set time.
CONT	The LED Lights continuously

16 LED.BSY

Turns the TX/BUSY Indicator lamp ON/OFF while receiving signals.

BSY ON	Turns the TX/BUSY lamp ON.
BSYOFF	Turns the TX/BUSY lamp OFF.

17 LED.TX

Turns the TX/BUSY lamp ON/OFF while transmitting signals.

TX ON	Turns the TX/BUSY lamp ON.
TX OFF	Turns the TX/BUSY lamp OFF.

18 LOCK

Configures the lock mode setting.

LK KEY	Locks the front panel keys.
LK PTT	Locks the front panel keys and PTT switch.
LK P+K	Locks the front panel keys, PTT switch and DIAL knob.

19 M/T-CL

Selects the function of the MONI/T-CALL switch

MONI	Pressing this switch opens the squelch.
TC1750* / TC2100 / TC1000 / TC1450	Pressing this switch activates the T-CALL (1750 Hz/2100 Hz/1000 Hz/1450 Hz) for Repeater access.

(*: European version)

20 MEM.DEL

Deletes the memory channel.

See the Operating Manual for details.

21 MEM.TAG

Edits the memory channel tag.

See “Using Memory Tag” for details.

22 PAG.ABK

Turns the pager answer back Function ON/OFF

When called by another station corresponding to the pager code, the transceiver is automatically placed in the transmit mode (for about 2.5 seconds) to notified the other station that you are ready to communicate.

ABK.OFF	Does not transmit automatically.
ABK.ON	Transmits automatically.

See “Using the Pager Answer Back” for details.

23 PAG.CDR

Specify the receive personal Enhanced CTCSS Paging code.

Set the pager code for receive to be called by other stations.

01 – 05 – 50, 01 – 47 – 50	Set the receive “pager code” to be called by other stations.
---------------------------------------------	--------------------------------------------------------------

See “Setting the Code for Your Station” for details.

24 PAG.CDT

Specify the transmit personal Enhanced CTCSS Paging code.

Set the pager code (transmit) to call to other stations.

01 – 05 – 50, 01 – 47 – 50	Set the pager code to transmit calls to other stations.
---------------------------------------------	---------------------------------------------------------

See “Calling a Specific Station” for details.

25 PRI.RVT

Turns the Priority Revert feature ON/OFF.

RVTOFF	The Priority Revert feature OFF.
RVT ON	The Priority Revert feature ON.

See “Priority Revert Mode” for details.

26 PSWD

Turn the password function **ON** or **OFF**.

A 4-digit password may be set to prevent unauthorized operation of the transceiver without permission.

PWD.OFF	Disables the PASSWORD function.
PWD. ON	Enables the PASSWORD function.



- Set Mode “26 PSWD” cannot be set to “PWD. ON”, until the 4-digit password has been set in the Set Mode “27 PSWDWT”.
 - If the password is forgotten, the password cannot be deactivated without the all reset. If performing the all reset, all the transceiver settings are initialized. Do not forget the passwords.
-

27 PSWDWT

Input the 4-digits password (4-digits only).

1. Press the Function key to enable the cursor.
2. Press the numeric key to input the 4-digits password.
 - [▲] key: Moves the cursor to the right.
 - [▼] key: Moves the cursor to the left.
3. Press the **PTT** switch to save the setting and return to normal operation.

28 RF SQL

A special RF Squelch feature may be set so that only signals exceeding a certain S-meter level will open the squelch.

OFF	Normal squelch operation. RF Squelch is OFF.
S-1 – S-FULL	Only signals exceeding the set S-meter level will open the squelch.

29 RPT.ARS

Set the **ARS (Automatic Repeater Shift)**.

Enable or disable the automatic Repeater Shift operation **ARS (Repeater operation is initiated by tuning to the repeater frequency)**.

ARS.ON	Set the repeater shift offset frequency.
ARS.OFF	Disables the ARS function.

See the Operating Manual for details.

30 RPT.FRQ

Set the Repeater Shift offset frequency.

0.025M – 99.975M	Set the repeater shift offset frequency.
-------------------------	------------------------------------------

31 RPT.SFT

Sets the repeater shift direction.

SIMPLX	No TX frequency offset.
-RPT	Shifts TX to a lower frequency.
+RPT	Shifts TX to a higher frequency.

See the Operating Manual for details.

32 RXSAVE

Selects the Receivemode Battery Saver interval (“sleep” ratio)

200 MS - 2 SEC	Enables the battery save function. Receiving is automatically OFF during the set time, no signal is heard.
OFF	Disables the Battery save function.

33 SCN.LMP

Turns the scan lamp ON/OFF while paused.

ON	When stops scanning temporarily, the back light turns ON.
OFF	The back light does not illuminate when scan stops.

34 SCN.RSM

Configures the scan stop mode settings.

BUSY	The scanner will halt on a signal it encounters. Scanning will resume one second after the other station signal ceases transmitting. In the case of constant-carrier signals like Weather Station broadcasts, the scanner will likely remain on this frequency indefinitely.
HOLD	The scanner will halt on a signal it encounters. Scanning will only resume when it is manually re-initiated.
TIME	The scanner will halt on a signal it encounters, scanning will resume after five seconds even if a signal is still on the frequency. To cancel scanning, press the the PTT switch, [▲] or [▼] key.

See the Operating Manual for details.

35 SKIP

Selects the Memory Scan “Skip” channel-selection mode.

OFF	All memory channels will be scanned (the “flag” will be ignored).
SKIP	The scanner will “skip” the flagged channels during scanning.

36 SQL.TYP

Selects the Tone Encoder and/or Decoder mode

See “Selecting the Squelch Type” for details.

37 STEP

Sets the frequency steps.

AUTO	Step automatically changes according to operating frequency.)
5.0 / 6.25* / 10.0 / 12.5 / 15.0 / 20.0 / 25.0 / 50.0 / 100.0 k	Step according to set steps.

(*: European version only)

38 TN FRQ

Sets the TONE frequency.

OFF / 67.0 R - 100.0 R - 254.1 R	Sets the TONE frequency for receive.
OFF / 67.0 T - 100.0 T - 254.1 T	Sets the TONE frequency for transmit.

See “Setting CTCSS Tone frequency” for details.

39 TOT

Set the transceiver to automatically return to receive mode after transmitting continuously for a certain period of time. The TOT function limits inadvertent transmission of unnecessary signals, and unwanted battery power consumption (time-out timer function).

1MIN - 3MIN - 30MIN	Set the transceiver to automatically return to receive mode after transmitting continuously for the set period of time.
OFF	The TOT time is deactivated

The beep sounds at about 10 seconds before returning to return to receive mode automatically.

40 TX PWR

Selects Transmitter Power

HIGH	5 W power output level
MID	2.5 W power output level
LOW	0.5 W power output level

See the Operating Manual for details.

41 TX SAVE

Turns the Transmitter Battery Saver ON/OFF.

SAVOFF	The Transmitter Battery Saver ON
SAV ON	The Transmitter Battery Saver OFF

42 VFO.SPL

When working on repeaters with odd splits, or communicating with astronauts on orbiting space vehicles, it may be necessary to use nonstandard splits between the receive and transmit frequencies. If the application is infrequent enough not to warrant the dedication of a memory channel for this purpose, the “VFO Split” mode may be used.

VSP.OFF	Turns the “VFO Split” operation OFF.
VSP. ON	Turns the “VFO Split” operation ON.

43 VOX

The VOX system provides automatic transmit/receive switching based on voice input to a VOX compatible headset or internal/external microphone. With the VOX system enabled, you do not need to press the PTT switch in order to transmit.

VOXOFF	Turns the VOX function OFF.
VOX ON	Turns the VOX function ON.

44 WFM.RCV

Broadband FM Transceiver (WFM) function Enables/Disables.

WFM. ON	Turns the Wide FM function ON.
WFM.OFF	Turns the Wide FM function OFF.

45 W/N.DEV

Set the transmit modulation level. Select “WIDE” for normal operation.

WIDE	Normal transmission modulation level (± 5 kHz).
NARROW	The level is half of the normal transmit modulation level (± 2.5 kHz).

46 WX ALT

Set the weather Alert scan Feature, used for notifying storms and hurricanes, ON or OFF.

ALT.OFF	Disables the Weather Alert Scan Feature.
ALT. ON	Enables the Weather Alert Scan Feature.

Cloning

The **FT-4XR/XE** includes a convenient “Clone” feature, which allows the memory and configuration data from one transceiver to be transferred to another **FT-4XR/XE**. This can be particularly useful when configuring a number of transceivers for a public service operation. Here is the procedure for cloning data from one transceiver to another:

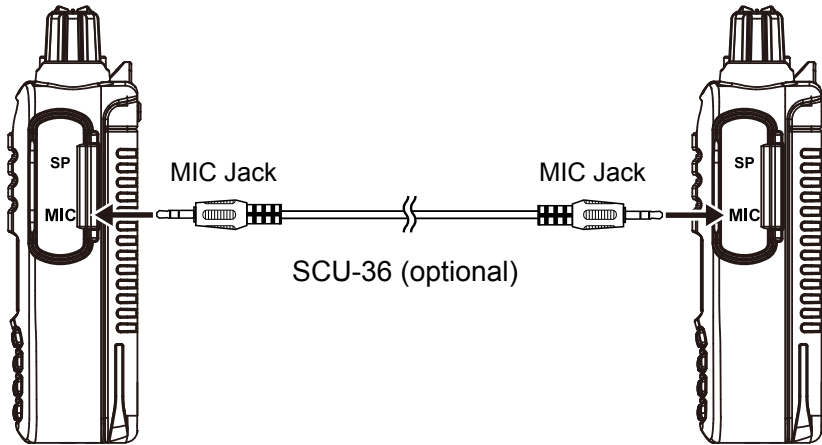

1. Turn both transceivers **OFF**.
2. Connect the optional SCU-36 Cloning Cable between the MIC jacks of the two transceivers.
3. Press and hold the **MONI/T.CALL** switch and the PTT switch simultaneously, while turning the transceiver ON.
 - Do this for both transceivers (the order of switch-on does not matter).
4. Press the [▲] or [▼] key on each transceiver to select “F6 : CLONE”, then press the Function key momentarily.
 - When the Clone mode is successfully activated in this step, “CLONE” message will appear on the displays of both transceivers.
5. Press the **PTT** switch on the source transceiver.
 - “- - TX - -” will appear on the source transceiver, and the data from this transceiver will be transferred to the destination transceiver.
 - “- - RX - -” will appear on the destination transceiver.
 - When data transmission begins, the transmission data amount bar graph appears on the LCD.
6. If the data transfer is successful, “CLONE” will appear on both displays.
7. Turn both transceivers off and disconnect the cloning cable.



When the “ERROR” appears on the LCD during data transfer, copying cannot be completed. Check the clone cable connection, and redo the operation from the beginning.

Troubleshooting

If you suspect a malfunction, check the following items before requesting a repair.

● The transceiver does not turn on.

- Is the battery depleted?
- Charge the battery pack after purchase, and when the transceiver has not been used for a long time.
- Is the battery pack properly attached?

Refer to "Installing the Battery Pack" on the Operating Manual and securely install the battery pack.

● There is no sound.

- Is the squelch level (or S meter squelch) set too high?
Press the MONI/T.CALL key and verify that you can hear white noise.
Adjust the squelch level (or S meter squelch) when receiving a weak signal.
- Is the volume low?
Rotate the PWR/VOL knob clockwise to increase the volume.
- Is the tone squelch or DCS on?
When the tone squelch or DCS is on, the sound is not output until the transceiver receives a signal containing the same tone frequency or DCS code set.

● There is no transmission of radio waves.

- Are you pressing the PTT switch properly?
- Is the PTT lock on?
- Is the Busy TX Block (Busy Channel Lockout function) on?
When the Busy TX Block (Busy Channel Lockout function) is on, transmission is inhibited when receiving a signal, even if the PTT switch is pressed. Wait until the signal being received stops and then press the PTT switch.
- Is the transmission frequency on a ham radio band?
- Is the voltage of the battery pack correct?
Check the remaining charge on the battery pack.

● The keys or PTT do not respond.

- Is the Keypad Lock or PTT Lock on?

● The battery pack cannot be charged or battery power depletes immediately after charging.

- Is the battery pack being charged with a charger specified by Yaesu?
Charge the battery pack using the accessory Battery Adapter (SAD-20B/C/U/G) or the Rapid Charger (SBH-22).
- Is the battery pack in use exhausted?
If the red blinking ("Charging Error") appears on the rapid charger cradle indicator when charging, there is a chance the battery pack is over discharged. If the error is repeatedly displayed after charging the battery pack several times, the battery pack may have reached its service life or be defective. Batterypacks are consumables. Please replace an exhausted battery pack with a new one immediately. Battery packs can be charged and reused up to approximately 300 times.
- Charge the battery pack within the temperature range from +5 °C to +35 °C (+41 °F to +95 °F).

Some specific combinations of signals may cause internal beats ("birdies") from high frequencies, caused by the internal oscillator. This is not a malfunction.

(See the calculation formula below: "n" is for the arbitrary integer). Also, depending on the combination of simultaneously received signals, there may be fluctuations in receive sensitivity.

- Receive Frequency = 13 MHz × n multiplicative
- Receive Frequency = 19.2 MHz × n multiplicative



Copyright 2018
YAESU MUSEN CO., LTD.
All rights reserved.

No portion of this manual may be
reproduced without the permission of
YAESU MUSEN CO., LTD.

YAESU MUSEN CO., LTD.

Tennozu Parkside Building
2-5-8 Higashi-Shinagawa, Shinagawa-ku, Tokyo 140-0002 Japan

YAESU USA

6125 Phyllis Drive, Cypress, CA 90630, U.S.A.

YAESU UK

Unit 12, Sun Valley Business Park, Winnall Close
Winchester, Hampshire, SO23 0LB, U.K.