

XIEGU COMMUNICATION



X5105

HF+50MHz Portable HF Transceiver

Instruction Manual

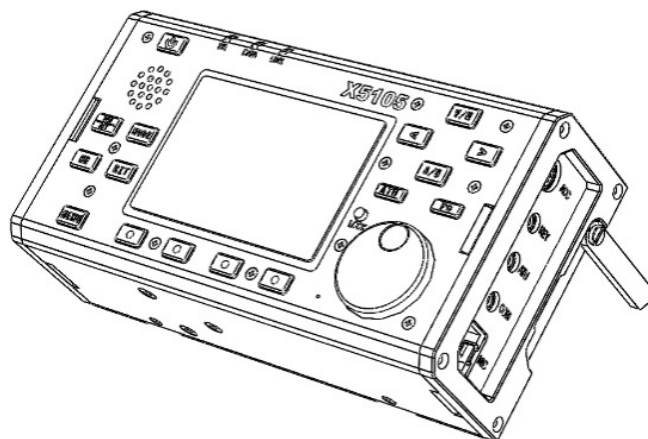

Chongqing Xiegu Technology Co.,Ltd.
www.cqxiegu.com

Important reminder:

Before operating the equipment, please read our operating manual carefully and keep the manual, so as not to lose.

Features:

- 3.6 inch LCD screen
- Built in 3800mAh large capacity battery pack
- Built in ATU
- Covers all modes of HF, 50MHz band (SSB/CW/AM/FM/RTTY/PSK)
- IF signal output
- Built in AF-DSP digital noise reduction processor
- Equipped with trestle for desktop operation
- Very small in size and ultra portable

Security considerations:



Do not use equipment during a lightning storm.



Damp-proof!



Don't illegal operations!



Note RF high-voltage of antenna connector!

Packing list:

Qty

- | | | |
|---|-------------------------|---|
| ① | X5105..... | 1 |
| ② | Power supply cable..... | 1 |
| ③ | Hand microphone..... | 1 |
| ④ | USB Cable..... | 1 |
| ⑤ | Service card..... | 1 |

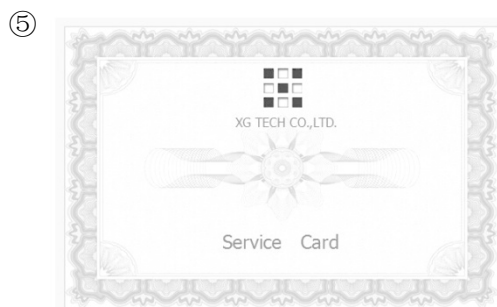
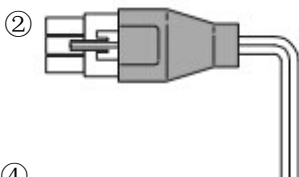
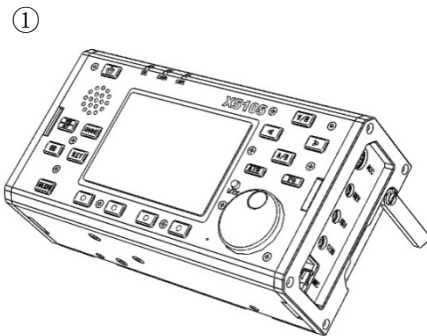

1 X5105 Specifications

Basic Specifications

Frequency range:

Receive: 1MHz-55MHz

Transmitting: 160 meters -6 meters (Amateur band only)

Operating mode: A1A(CW) , A3E(AM) , J3E(USB/LSB) , F3E(FM)

minimum frequency stepping: 1Hz

Antenna impedance: 50Ω

Operating temperature range: -10°C ~ +60°C

Frequency stability: after turn on the radio 1-60 minutes is ± 2 ppm,
@25°C : 1ppm/hour

supply voltage: normal: 13.8VDC + 15%, negative grounding

Operating voltage: 9.0-15.0VDC, negative grounding

Current consumption: receive: 660mA@ Max transmit: 2.5A@ Max

Battery capacity: 3800mAh @12V

Dimensions: 160*100*46mm[does not include protrusion]

Weight: 0.94Kg[host only]

Transmitter parameters

Transmitter power : 5W(SSB/CW/FM) , 1.5W(AM carrier) , @13.8VDC

Modulation mode: SSB balanced modulation/AM low level amplitude modulation/FM

Variable reactance frequency modulation

FM Maximum frequency swing: ± 5 kHz

spur reduction: -45dB

Carrier suppression: > 40dB

Sideband spurious: > 50dB

SSB frequency response: 400Hz-2800Hz (-6dB)

Microphone impedance: 200-10k(conventional 600Ω)

Receiving parameters

Circuit type: double frequency conversion superheterodyne + audio DSP

IF frequency: first IF: 70.455MHz second IF: 10.695MHz third IF: 455kHz (FM)

Sensitivity

	SSB/CW	AM	FM
500kHz-1.8MHz	/	10uV	/
1.8MHz-28MHz	0.25uV	2uV	/
28MHz-30MHz	0.25uV	2uV	0.35uV
50MHz-54MHz	0.25uV	2uV	0.35uV

(PRE=on, ATT=off, NB=off, NR=off, SSB/CW/AM = 10dB S/N, FM = 12dB SINAD)

Image rejection: 70dB

If Rejection: 60dB

Selectivity: SSB : -6dB:2.4kHz/-60dB:4.6kHz

CW : -6dB:500Hz/-60dB:2000Hz

AM : -6dB:6.0kHz/-60dB:25.0kHz

FM : -6dB:12.0kHz/-60dB:25.0kHz

Audio output: 0.6W (8Ω , ≤10% THD)

Audio output impedance: 4 – 16Ω

Interface definition

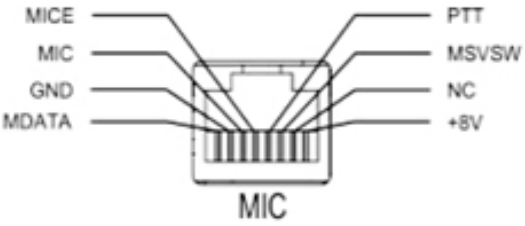
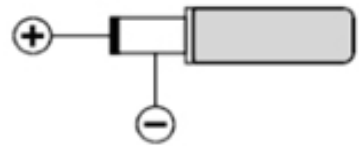
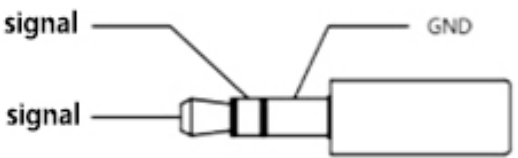
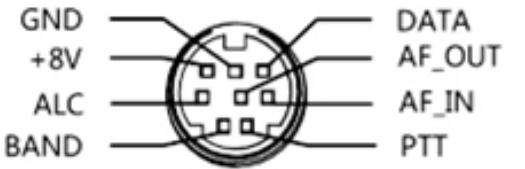
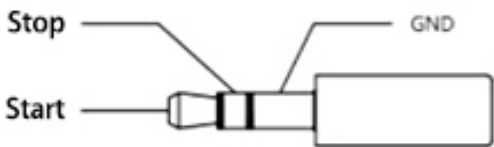
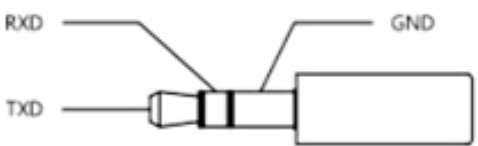
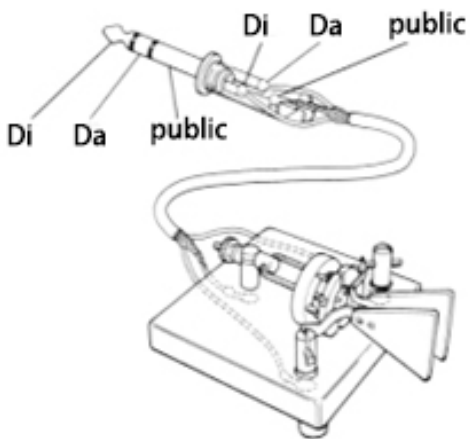
Microphone interface	DC power input 13.8V
 <p>MICE MIC GND MDATA</p> <p>PTT MSVSW NC +8V</p> <p>MIC</p>	 <p>+</p> <p>-</p>
<p>ACC</p>	<p>External connection speaker / earphone</p>
	 <p>signal</p> <p>signal</p> <p>GND</p>
 <p>GND +8V ALC BAND</p> <p>DATA AF_OUT AF_IN PTT</p>	<p>ATU</p>  <p>Stop</p> <p>Start</p> <p>GND</p>
	<p>Key</p>
<p>COM</p>  <p>RXD</p> <p>TXD</p> <p>GND</p>	 <p>Di</p> <p>Da</p> <p>public</p> <p>Di</p> <p>Da</p> <p>public</p>

Charging and maintenance of internal battery

X5105 has a built-in 5000mAh battery pack. When the external power supply is not connected, the battery pack supplies power to the X5105, when the X5105 is connected with an external power supply, the circuit inside the machine automatically switches to the external power supply.

Charging method:

- 1 In the menu, select [CHG] option, start charging function.
- 2 The external power supply voltage is set between 13.5V-14.0V and the power supply is connected to the X5105 external power supply.
The host will automatically start charging.
- 3 Charging time is 10 hours. By then, the charge will automatically stop.

When the battery is powered for X5105, when the battery power is about to run out, the power indication sign on the upper right corner of the screen is displayed as . At this point, the X5105 should be charged or switched to an external power supply. During the charging process, the casing of the machine has a slight fever.

Normally, the lifetime of the internal battery is about 4-5 years. Please replace the battery when the battery has a noticeable capacity drop or charge fails.

When the X5105 is connected to an external power source, and when the X5105 is in the transmitting state, it is strictly forbidden to disconnect the power supply so as not to damage the power management chip.

Please turn off the power immediately when the machine shell is very hot near the battery, and put the equipment in a safe and ventilated place. After confirming the safety situation, please contact us for proper handling.

2 Description of equipment

2.1 Front panel button function

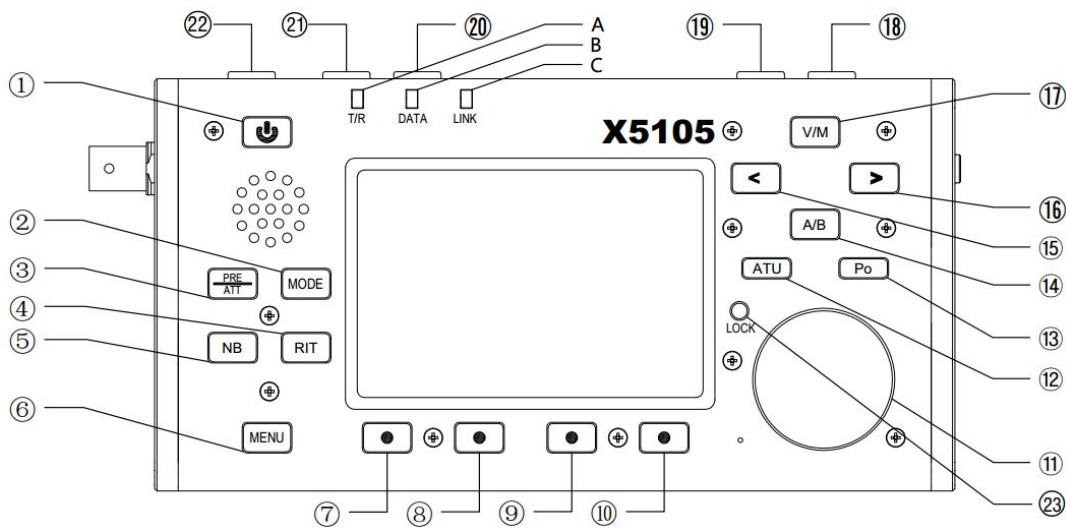

① Power button

Press this button for a second to turn on or turn off the radio.

② Mode button

With this key, you can change the mode of operation and will cycle in the following mode:
[LSB-USB-CW-AM-FM]

③ PRE/ATT button

With this key, the preamplifier or pre attenuator will be turned on or be turn off in the following states: [PRE=ON--ATT=ON--PRE/ATT=OFF]

④ RIT button

With this key, the receive frequency adjustment function is turned on or turn off.

⑤ NB button

With this key to turn on or turn off the NB function.

⑥ MENU button

With this key, you can switch the current display of the multi-function menu.

⑦ -⑩ Multifunctional menu button

Press these four buttons to turn on or off the corresponding function displayed on the menu area on the current screen.

⑪ Major tuning knob

The main tuning knob of X5105, can be used either for frequency regulation or for menus.

⑫ ATU button

When the key is pressed for a short time, the automatic antenna tuner will be connected to the antenna port, by pressing this button for a long time, the automatic antenna tuner

will be started.

⑬ Po button

With this key, and with the main tuning knob, the power of the transmitter can be adjusted. The range of adjustment is from 0.5W-5W, stepping for 0.5W.

⑭ A/B button

With this key, you will switch between VFOA-VFOB.

⑮ < button

With this key, the current frequency step carries one bit to the left.

⑯ > button

With this key, the current frequency step carries one bit to the right.

⑰ V/M button

With this key, you can switch between VFO mode and MEMO mode.

⑱ Up button

With this key, X5105 can be switched to higher frequency bands.

⑲ DN button

With this key, X5105 can be switched to lower frequency bands.

⑳ - button

With this key, you can reduce current volume.

㉑ + button

With this key, you can increase current volume.

㉒ PTT button

Press and hold this button, X5105 will go into the transmit state.

㉓ LOCK button

If you press this button for a short time, you will lock all buttons and knobs on the panel; By pressing this button for a long time, you can set the backlight on / off.

Status indicator		
A [T/R]	B [DATA]	C [LINK]
Transmit/Receive switch indication	Data indication	Peripheral connection indication

Indicator color description:

A T/R indicator

When the X5105 is in receiving mode, the indicator light is green.

When the X5105 is in transmitting mode, the indicator light is red.

B DATA indicator

When the data signal or channel are busy, the indicator light flashes.

C LINK indicator

When the host is connected with the external equipment, the indicator light will shine.

Function menu corresponding to 4 multi-function buttons below screen.

1.

A=B	SPL	NR	NTH
Copy VFOA to VFOB	Split On/Off	Digital noise reduction	Notch

2.

AGC	FIL		
Automatic gain control on / off, control speed	Filter selection		

3.

M>V	MW	MC	TAG
Save the current channel in VFO and return to VFO mode	Store current channel	Clear current channel	Channel display frequency / custom characters(Press this button for a long time to enter the TAG edit mode)

4.

	KEY	KSP	
	Key manual / automatic mode selection	Automatic key rate selection	

5.

RE1	RE2	RE3	/
Set CW message 1(Press this button for a long time to enter the CW message content editor)	Set CW message 2(Press this button for a long time to enter the CW message content editor)	Set CW message 3(Press this button for a long time to enter the CW message content editor)	/

6.

SQL	CMP	MTR	MSL
Squelch function	Speech compression	switch display Po/SWR	Internal / external microphone selection

7.

SRM			
Scan receive mode(frequency spectrum)			

8.

IFO			VER
IF output switch			Version information display

Screen display information

The diagram illustrates the screen display information of a radio. The screen is divided into several functional areas:

- Work mode information:** Located at the top left, showing 'VFO-A FM'.
- Host status information:** Located at the top right, showing 'LINE', 'MEMO', and 'MODE'.
- working frequency:** The large central display showing '50.025.000'.
- Multifunctional instrument area:** Below the frequency, showing 'S' (signal strength) with a scale from 1 to 9, 'Po' (power) with a scale from 20 to 100%, and 'Vel' (velocity).
- Advanced functional status indication area:** Below the instrument area, showing 'COMP', 'PRE', 'ATT', 'AGC-M', 'NR', 'NB', and 'FIL-0.5k'.
- Current channel information:** Shows 'RIT +0.05' and 'CH 000'.
- Lock flag:** A small icon on the right side of the screen.
- Multi function menu area:** At the bottom, showing 'Messages' and a menu with options: '1', 'AGC', 'KEY', 'CMP', and 'FIL'.

2.2 Left panel interface function

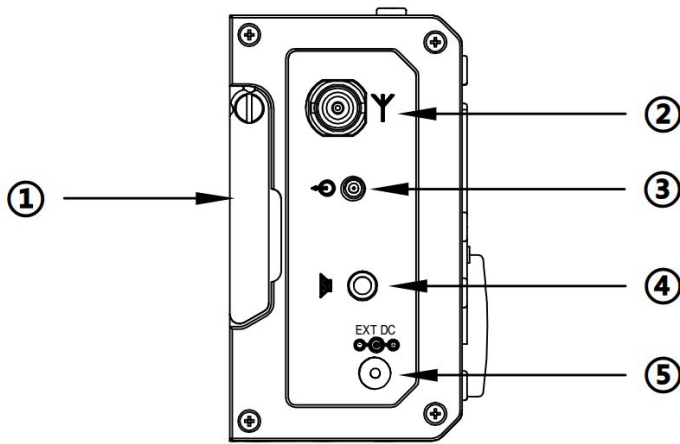

① Left bracket

Rotate the bracket when using it, when after using it, take it back to the side shield.

② Antenna interface

Connect the antenna to the 50 ohm coaxial cable with the Q9 connector.

③ IF signal output port

The first IF signal is output for use by the XDT1.

* XDT1 is a data terminal equipment of Xiegu.

④ External speaker / earphone interface

This interface is 3.5mm stereo socket (3 line, left and right channel machine linked together), it can connect external speaker (impedance 4-16) or earphone.

⑤ DC power interface

The external DC power input interface, it uses the standard power cord to connect the external stable DC power to this interface. The external DC power supply must be able to provide the power output of the [13.8V@3A](#). The interface can also be used to charge for internal battery.

2.3 Right panel interface function

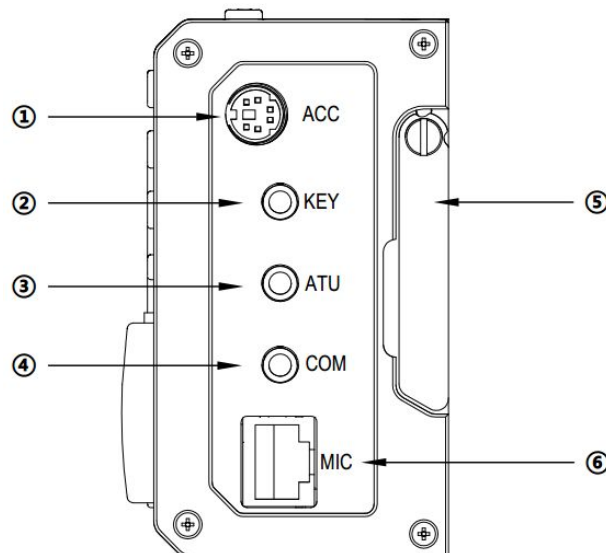

① ACC interface

The interface is a 8PIN micro DIN interface, it can be used for external power amplifier, ALC control, PTT control, band signal transmission, it can also be used to communicate with the computer for PSK communication when the audio signal input / output.

② KEY interface

The interface is 3.5mm's stereo interface, which can be used to connect manual / automatic telegraph keys.

Key connection is shown in this figure:

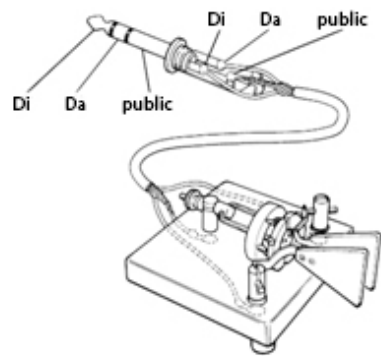

③ ATU interface

The interface is a 3.5mm interface (3 lines) that can be used to control external power amplifiers with antenna tuning.

④ COM interface

The interface is a 3.5mm interface (3 wire) which used for the connection of the computer aided control system.

⑤ Right bracket

Rotate the bracket when using it, when after using it, take it back to the side shield.

⑥ MIC (microphone) interface

The interface can be used for microphone connections.

2.4 Handheld microphone function

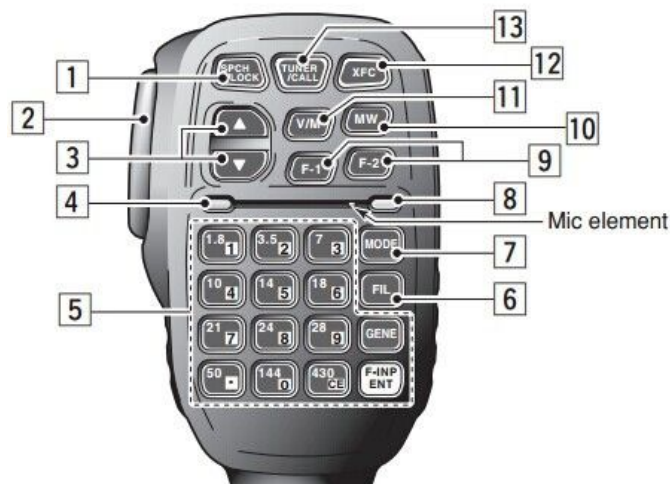

1. LOCK button, you can lock the host button and the mouse button via this button, and press it again to unlock.
2. PTT button, transmitting control button.
3. Move up/down, adjustable frequency increase, subtraction, or selection of items in the menu.
4. Receiving / Transmitting indicator light, microphone operated indicator light.
5. Digital key
6. FIL button, built in filter selection.
7. MODE button, selection of host operating mode.
8. Function indicator lamp, **No** indication.
9. Function button, F1/F2 custom settings button.
10. MW button, store operation.
11. V/M button, frequency / channel switching.
12. XFC button, VFO-A / VFO-B switching.
13. CALL button, press this button for a long time to start the automatic antenna tuning in the host.

3 Operation

3.1 Turn on / off transceiver

1. Turn on the transceiver: just press  for a long time
2. Turn off the transceiver: in the boot state, press the key  for a long time.

3.2 Battery / voltage display

1. When the battery is powered by the built-in battery, the remaining battery power of the current battery will be displayed in the upper right corner of the display.
2. When using an external power supply, after switching the [VLT] menu, this position will display the voltage value of the current external DC power source that is currently connected to the transceiver.



3.3 Operating frequency band selection

The frequency range of X5105 covers 0.5~54MHz. The amateur frequencies in this range are divided into multiple frequency bands and can be switched in a number of different ways. You can complete the equipment operation according to the operation instructions in this section.

Operation method: press DN or UP key to switch to the next or last operation band respectively.

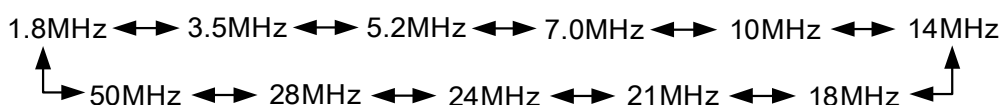
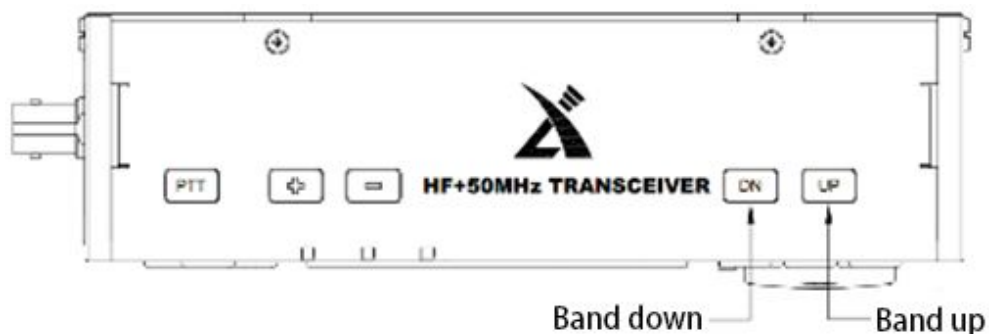

- A. The opening of the 5MHz frequency band is based on the regulations of the country (or region) where it is located.
- B. Different versions of the machine have different frequency divisions, depending on their country (or region) regulations.
- C. VFO-A and VFO-B are two separate VFO modes, which can be set to different frequency bands. Please refer to the [VFO settings].

3.4 Work mode selection

Press the [MODE] button to switch between all modes in a fixed order.

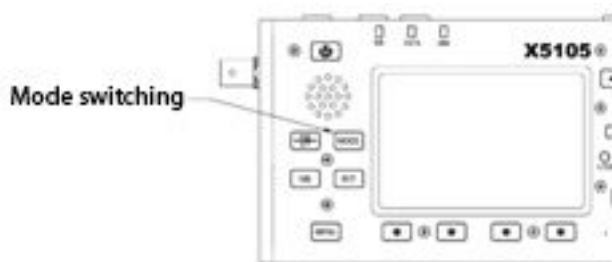
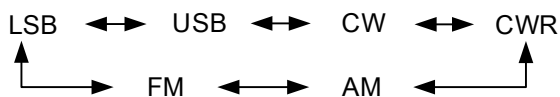

***VFO-A and VFO-B can be set to different operating modes in the same frequency band, thus realizing the different operation modes of "voice /CW".**

3.5 Adjust the volume

Adjust the output volume according to the volume plus and minus buttons.

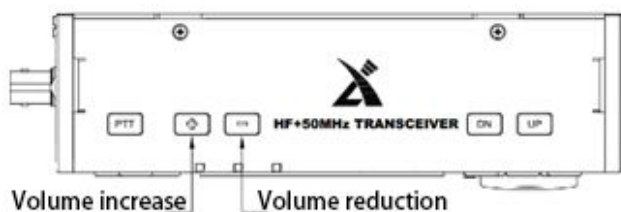

When using the AF-OUT port of the ACC interface, adjusting the volume level will do the same for this port.

3.6 Regulated transmit power

Press the [Po] transmit power setting button, you can set the transmit power.

- A. Press the [Po] button to enter the power setting state, and the screen will display the Po power set bar table.
- B. Rotate the big knob, set the power, step 0.5W.
- C. When the settings are complete, press the [Po] button again, save and exit the setup mode.

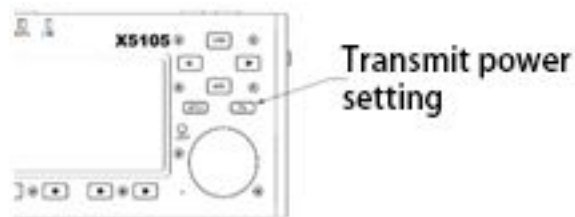

When you do not understand the current state of the antenna, minimize the set transmit power value for the first time you use the X5105 transceiver.

3.7 Use the host PTT button

X5105 comes with a PTT button, you can start the transceiver's transmission through this button.

Operation method:

- A. Press this button to start the transmitting function.
- B. Speaking into the built-in MIC hole, can be completed communications.



3.8 Set operating frequency

There are two ways to set the X5105 operating frequency, use the big knob to set the frequency, or use the multi-function mic to set the frequency.

Operation method:

- A. Use large knob to set frequency
Press the button [<] or [>], move the cursor of the frequency bit to the left or to the right, select the frequency of the desired step.
Rotating frequency knob sets the frequency of the current step.

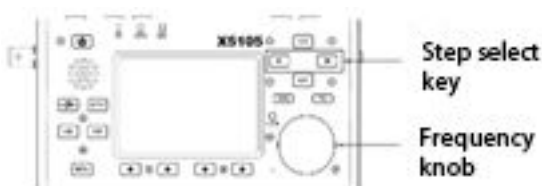

-
- B. Use a multi-function microphone for frequency setting
Press the [F-INP ENT] button on the cursor, and the X5105 enters the frequency setting. The cursor appears on the left of the frequency display bit.
Enter the desired frequency value in turn, and then press [F-INP ENT] button again to complete the frequency setting.

For example, set the current frequency to 51.050000MHz, and press the order as follows:

First, press the [F-INP ENT] button.

Please press the 51.050000 numeric key in turn.

Once again press the [F-INP ENT] button to complete the settings.

3.9 Start the ATU (automatic antenna tuner) into the tuning function

X5105 transceiver built-in an efficient automatic antenna tuner, which can help you easily complete the erection and debugging of the antenna.

Press the [ATU] button for a long time, it will start the ATU auto tuning function. When the tuning is complete, the host will automatically return to the receiving state.

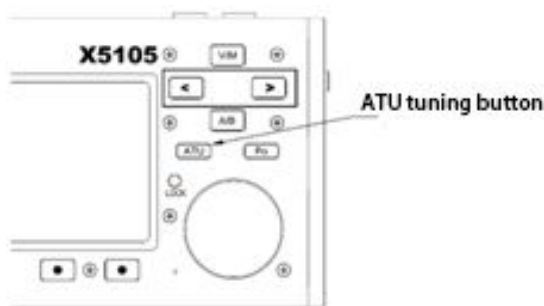

3.10 RIT (receive frequency trimming)

Relative to the set frequency, the RIT function can set the offset value of the actual receiving frequency of the maximum $\pm 5\text{kHz}$.

Operation method:

- A. Press [RIT] button to start RIT function.
- B. The rotating knob can change the receiver frequency in the range of $\pm 5\text{kHz}$. The screen has the corresponding area to display the frequency change value.
- C. If you want to turn off the RIT function, press the [RIT] button again. When the RIT function is enabled again, the last RIT setting will still be used.
- D. If you want to clear the RIT offset, in the RIT open state, turn the knob and set the offset to zero.

If the frequency offset range more you want, you can use pilot frequency transceiver mode. Please refer to the VFO instructions for details.

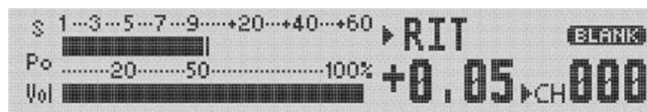
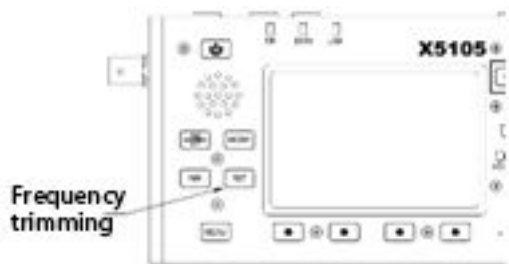

3.11 Automatic gain control (AGC)

By adjusting the proper recovery time parameters of the AGC automatic gain control system, the receiver can achieve the optimum state effect.

Operation method:

- A. Switch to the second page menu, press the corresponding multi-function button to select the AGC function.
- B. The AGC function will be selected in the following order:

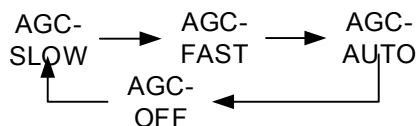

When you select "AGC-AUTO", the CW mode is actually "AGC-FAST", in voice mode is "AGC-SLOW."

If AGC-OFF is selected, the AGC system is turned off and the display of the S table is stopped.

3.12 Preamplifier / preattenuator (PRE/ATT)

Pre amplifier (PRE) and pre attenuator (ATT) can improve the receiver's listening effect. When the signal is weak, the preamplifier can be switched on to increase the signal strength. When the signal is strong, the preamplifier can be switched on to reduce the signal strength.

Of course, you can also choose to turn off the circuit unit so that the signal will by pass.

Operation method:

- A. Press the [PRE/ATT] button to start the function.
- B. The switching sequence will follow the following loop:

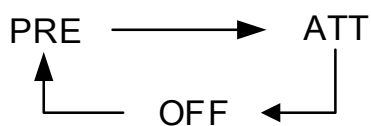

In the low frequency waves (less than 10MHz) operation, the preamplifier can be closed, then let signal in by-pass state, it will be more conducive to improve the receiving effect, And it can avoid the blocking of receiver caused by strong interference signal. Typically, when the S table is still changing, the preamplifier is not need to turned on.

3.13 Noise suppressor NB

Noise suppressor can effectively eliminate some specific pulse type interference, especially the noise produced by the automobile ignition system, and can improve the receiving effect obviously.

Operation method:

- A. Press the [NB] button, the screen appears corresponding prompt information, NB function is turned on.
 - B. Press the [NB] button again, it will turn off the NB noise suppressor.
- * The NB function can only suppress the pulse noise of a specific type, and can not replace the NR noise reduction function.

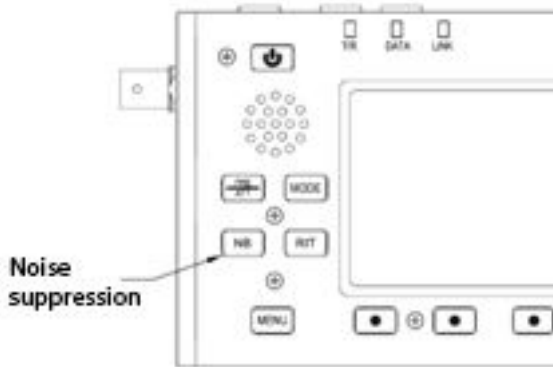

3.14 Pilot frequency operation SPL and VFOA/B setting

There are two independent VFO in X5105 transceiver, which can set different frequencies and modes respectively. Set the VFO reasonably, and with the menu SPL function, you can easily achieve pilot frequency transceiver operation mode.

VFO settings:

- A. Press the [A/B] button, you can switch between VFO-A and VFO-B.
- B. When you switch to a certain VFO state, you can set the current VFO's working frequency, working mode, and so on.

Pilot frequency transceiver operation method:

- A. First set the receiver frequency and mode (VFO-A).
- B. And then set the transmit frequency and mode (VFO-B).
- C. Press [MENU] button, switch to the first page menu, select the SPL function, it opens the pilot frequency transceiver working mode.

*You can also make full use of VFOA/B to set different frequencies or modes, so double frequency monitoring can be achieved via real-time switching.

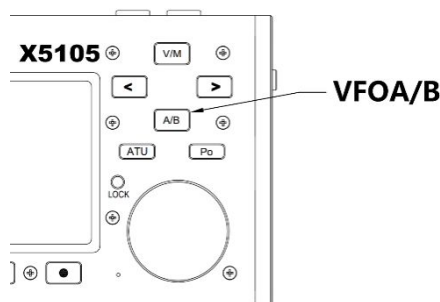

3.16 VFO mode /MEMO mode (V/M) setting

Transceiver can switch between VFO mode and MEMO mode, and realize flexible operation mode.

Operation method:

- A. Press the [V/M] button, you can switch between the VFO mode and the MEMO mode.

B. In the current mode, press the [V/M] button, and then switch to another mode.

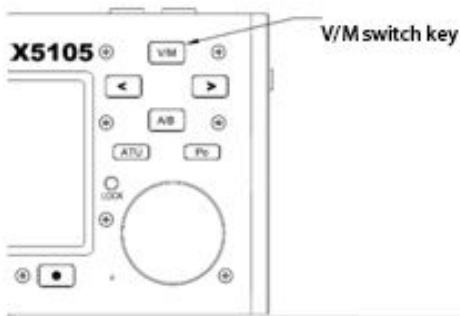

3.17 Lock button operation

The lock key (LOCK) can avoid the incorrect triggering of the transceiver and the microphone during outdoor operation.

Operation method:

- A. Press the [Lock] button for a long time to start the lock.
- B. Press the [Lock] button for a long time again to turn off the lock.
- C. The icon  appears on the corresponding area of the screen.

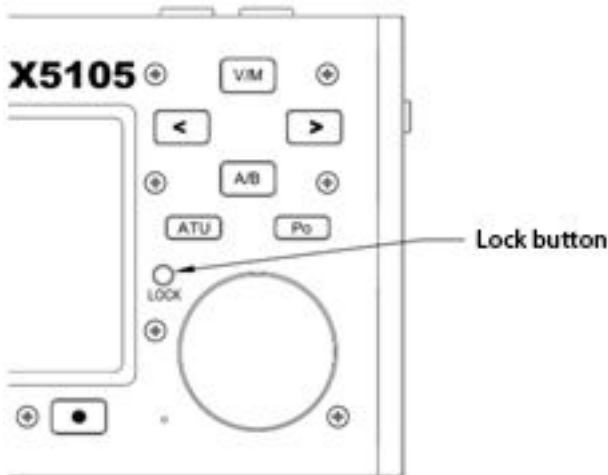

3.18 CW communication

Operate with a hand key or an external keying device.

Operation method:

- A. Insert the plug of the key (three wire) into the KEY interface on the right.
- B. Press the [MODE] button and switch mode to CW (or CWR).
- C. Press the [MENU] button for a long time, adjust the Menu #08 (CW DELAY) and set the delay time (default: 500ms). Press the [SAVE] button to save the new settings and exit the menu mode.
- D. Press the CW key, you can do the CW communication.
- E. The tone of the CW sidetone can be adjusted by Menu #09 (CW TONE), as follows:
 - ① Press [MENU] button for a long time to enter menu mode.
 - ② Regulating Menu, #13 (CW, TONE).
 - ③ Select the required tone, range from 200~2000Hz to adjustable, and the default

value is 800Hz.

- ④ After you complete the operation, press the [SAVE] button briefly, save the new settings and exit the menu mode.

Using the built-in automatic key controller makes it easy to generate CW points, with the following methods of operation:

- ① Press the [MENU] button briefly, switch to the fourth page menu, and select the KEY function as KEY-A.
- ② Select the KSP function, rotate the frequency knob, adjust the automatic key rate, press the corresponding function button of KSP again, save and return.

3.19 Channel storage

Regular channel storage:

- A. In VFO mode, parameters such as frequency, mode and advanced functional status are adjusted.
- B. Press the [MENU] button briefly, switch to the third page menu, select the V>M function, and start the channel editor.
- C. If the current channel is empty (not storing channel information), the channel number will flicker. Press the MW function key for a long time, after a "di" sound, the frequency information has been successfully stored on the channel.
- D. If the current channel has stored information, the channel number will not flicker. Rotate the knob to the nearest empty channel, press the MW function key for a long time, after a "di" sound, indicates that frequency information has been successfully stored on the channel.

Adjust storage channel:

- A. If in VFO mode, press the [V/M] button on the panel, it will enter the channel mode.
- B. Turn the knob, you can switch the current channel, the channel number will change accordingly.

Clear channel storage:

- A. In the channel mode, press the [MENU] button, switch to the third page menu, press the MC function key, start clear channel editing.
- B. At this point, the channel name or frequency value starts flashing. Press the MC button for a second, it will be heard twice "Di" sound, this indicates that the data in the current channel store is cleared and the channel number starts flashing, this indicating that the current channel number is empty.

3.20 Channel naming

The stored channels can be named with the labels of letters and numbers to facilitate channel classification (e.g., work). You can do the editing in the menu mode as follows:

- A. Bring up the channel you want to name.
- B. Press the [MENU] button for a long time, enter the menu mode, rotate the knob, transfer Menu#23 (MEMTAG).
- C. Press the button [>] to start the tag edit.
- D. Rotate the knob, select the first letter (or number, symbol) you want to edit, and then press [>] to enter the next letter position.

- E. Turn the knob again, select letters, numbers, characters, and press [>] to enter the next letter position.
- F. Repeat fifth steps until the tag editing is complete. Press the [MENU] key for a second, save the contents of the set tag and return to the normal operating state. In channel mode, press the [MENU] button briefly, switch to the third page menu, press the TAG function key, and display the label named for this channel.

*You can press the TAG function key for a second, and you will transfer Menu #23 (MEM TAG) .

3.21 The menu system can personalize the transceiver and make it more in line with your habits.

Operation method:

- A. Press the [MENU] button for a second and enter the menu mode.
- B. Press the [V/A] and [A/B] buttons to set the parameters you want.
- C. Rotate the knob to bring up the menu item you want to set.
- D. After the setting is complete, press the [MENU] key for a second, save the current setting and exit the menu mode.

* In the above fourth steps, if you press the [QUIT] button briefly, you will not save the new settings and exit the menu mode.

Menu system description

Menu item	function	Set value	default	
01	Filter 1 Fc	Filter 1 center frequency point (CW filter)	1M~100M	10.695M
02	Filter 2 Fc	Filter 2 center frequency point (SSB filter)	1M~100M	10.695M
03	Filter 3 Fc	Filter 3 center frequency point (AM filter)	1M~100M	10.7M
04	Filter 1 Bw	Filter 1 bandwidth (CW filter)	100Hz~100kHz	500
05	Filter 2 Bw	Filter 2 bandwidth (SSB filter)	100Hz~100kHz	2400
06	Filter 3 Bw	Filter 3 bandwidth (AM filter)	100Hz~100kHz	6000
07	RF Gain	Receive RF gain	10~100%	65%
08	CW Delay	CW T/RX switch delay	0~10000mS	500mS
09	CW Tone	CW transmit side tone frequency	200Hz~2000Hz	800Hz
10	SSB Tx Lv	SSB transmit modulation level	10~100%	50%
11	AM Tx Lv	AM transmit modulation level	10~100%	50%
12	NFM Tx Lv	NFM transmit modulation level	10~100%	100%
13	SSB Rx Lv	SSB receive audio gain	10~100%	50%
14	AM Rx Lv	AM receive audio gain	10~100%	50%
15	NFM Rx Lv	NFM receive audio gain	10~100%	40%
16	BackLight	Backlight brightness	0~100%	100%
17	Ref Clock	Reference clock frequency	1M~100M	26M
18	OutBand EN	Out of band permit	0~1	0
19	NFM Tx IF	NFM transmit if	1M~100M	10.697M

3.22 Restore factory settings:

When the parameter setting error and cannot be restored to the original parameters, you can use a restore factory settings function reset operation of the transceiver and transceiver on all the settings, the stored data will be cleared.

Operation method:

Press the RST button to restore the factory settings.

3.23 PSK communications and wiring instructions

X5105 transceiver can be connected with the computer, using the corresponding computer PSK software to complete the PSK communication.

Operation method:

- A. Connect the output of the SPK port to the AF IN of the PC using the stereo plug wire.
- B. Use ACC plug (MINI-DIN8) to connect the computer audio output to X5105. The computer end is a stereo plug.
- C. The data line is used to connect the X5105 to the computer and to ensure that the driver is properly installed. The HRD software can control the X5105 transceiver.
- D. After entering the HRD software, and then enter the PSK work interface, at this time you can communicate with PSK, X5105 transceiver is also controlled by the HRD software.
- E. Adjust the volume of the host to the right, observe the HRD software interface, avoid the audio amplitude is too large, resulting in no communication.

* In order to prevent interference, the radio and computer must be grounded. Data lines and audio cables, please install the EMC magnetic ring, and install as close as possible to the host of the radio station.

3.24 Band data format

The ACC port of the X5105 provides band data for each band. The band data can be used to control the peripheral, to make automatic band switching, or to identify the band information for other devices.

Band	Voltage	Band	Voltage	Band	Voltage	Band	Voltage
1.8MHz	230mV	7MHz	920mV	18MHz	1610mV	28MHz	2300mV
3.5MHz	460mV	10MHz	1150mV	21MHz	1840mV	50MHz	2530mV
5.0MHz	690mV	14MHz	1380mV	24MHz	2070mV	/	

After-sales service policy

1. Warranty:

This product has two years warranty effective from the date of purchase. This warranty covers only manufacturing- and parts defects. It does not cover damage caused by lightning, excess voltage on the power supply, accidental damage or purposeful damage or misuse.

If the product needs warranty repair within two weeks of receiving the product, XieGu will pay for the shipping both ways. After two weeks XieGu will pay only for return shipping.

If the product is not covered under warranty, the customer pays for shipping both ways plus the cost of the repair.

2. Warranty limitations:

Any of the following will void the warranty applicable to the product and its accessories:

- A. Modification-, removal-, or maintenance of the internal circuitry, without permission and authorization;
- B. Unauthorized change of product's embedded software;
- C. Immersion in liquid or signs of external damage;
- D. Warranty period expired;
- E. Product's serial number is missing, torn or blurred so we cannot determine if the radio is under warranty;
- F. Product was not bought from XieGu or authorized distributor of XieGu.

*None of the following conditions, are covered by the warranty:

- A. Damage caused by improper use by the user ;
- B. Damage caused by an accident ;
- C. Damage due to incorrect testing, maintenance, debugging, or other changes ;
- D. Damage is not caused by the material or the quality of production ;
- E. Damage to the shell or other external components due to improper use.

Contact us: service@cqxiegu.com



Xiegu communication

www.cqxiegu.com