

Programmable FM Scanning Receiver

with Direct Keyboard Entry System

VHF:30-50/144-174 MHz UHF:430-512 MHz



PRO-2001

OWNER'S MANUAL

PLEASE READ BEFORE
USING THIS EQUIPMENT

REALISTIC®

**CAT. NO.
20-115A**

CUSTOM MANUFACTURED FOR RADIO SHACK  A DIVISION OF TANDY CORPORATION

Welcome to computerized action radio! Your Realistic PRO-2001 Scanning Receiver combines deluxe scanner features with an advanced keyboard-controlled microprocessor, to give you more monitoring versatility, convenience and excitement than ever before.

With the PRO-2001, you have *direct* access to 16,560 frequencies spanning the six action bands: VHF-Lo, 30~50 MHz; Ham, 144~148 MHz; VHF-Hi, 148~174 MHz; Ham/Gov't., 430~450 MHz; UHF-Lo, 450~470 MHz; and UHF-Hi ("T"), 470~512 MHz. You'll never need to buy crystals (saving you \$6 to \$10 per channel!). And you won't need a cumbersome programming codebook for converting frequencies to switch positions. You simply enter the desired frequencies through a calculator-type keyboard. A big seven-digit display lets you know exactly which frequencies you're working with at all times.

Identifying and receiving the locally active channels is no problem with the PRO-2001. A powerful search function finds them for you! Hear ALL the action—including those unpublicized, "confidential" frequencies used by police, business and utility companies, etc. The PRO-2001 stores up to 16 of your favorite "discoveries" for high-speed automatic scanning that's similar to traditional scanner operation— but far more accurate.

The dual-conversion, superheterodyne receiver achieves its amazing performance through the use of highly complex but compact and reliable circuitry. It uses 44 transistors (four of which are field-effect type), two random access memories (RAMs), one large-scale-integration microprocessor system, one large-scale-integration PLL system, 15 integrated circuits incorporating the equivalent of hundreds of components, 71 diodes, a seven-digit LED display and 17 LED indicators.

You can use the PRO-2001 either at home (with 120 volts AC) or in your car, camper or boat (12 volts DC **negative ground**). Connect high-quality UHF and VHF antennas available at Radio Shack, and you'll be ready to use the most exciting action radio ever!

NOTE: Mobile use in some states and areas may be unlawful or require a permit—check with local authorities.

WARNING: TO PREVENT FIRE OR SHOCK HAZARD, DO NOT EXPOSE THIS RECEIVER TO RAIN OR MOISTURE.

- Program, Search and Scan functions controlled by a custom-designed, dedicated microprocessor—a computer on a chip!
- Zeromatic Tuning System (patent pending) automatically aligns discriminator circuitry to zero-tune the incoming signal
- Direct keyboard entry of any valid frequency
- Large digital display shows which frequencies are being scanned, monitored or programmed into memory
- Search capability with selectable upper and lower bounds—in different bands if you wish—with fast or slow search rate
- Monitor key provides a "17th channel"
- Dual conversion for high selectivity and sensitivity
- Crystal filter and three ceramic filters
- IC audio for clean, high-quality sound
- LED channel indicators
- Individual channel lockout buttons with skipper circuit
- Switchable scan delay
- AC and DC (**negative ground**) operation
- Universal mounting bracket

RADIO SERVICES COVERED

Amateur	Local Government	Press
Ambulances	Manufacturers	Public Mobile Radio
Automobile Emergency	Marine	Railroad
Business	Mobile Telephones	Rural Radio
Disaster Relief	Motion Pictures	School Buses
Fire	Motor Carrier	Special Emergency
Forestry Conservation	Petroleum	Special Industrial
Highway Maintenance	Physicians	Taxicab
Hospitals	Police	Telephone Maintenance

For your own protection, we urge you to record the Serial Number of this unit in the space provided. You'll find the Serial Number on the back panel of this unit.

Serial No.

SPECIFICATIONS

SEMICONDUCTOR COMPONENT:	2 C-MOS RAMs, 1 LSI Micro-processor System, 1 LSI PLL System, 15 integrated circuits, 44 transistors, 71 diodes, 7-digit LED display and 17 LEDs.		ADJACENT CHANNEL REJECTION:	60 dB
RECEIVING SYSTEM:	Superheterodyne with digital synthesizer to receive 16,560 programmable frequencies		SEARCH RATE	
			Fast Search:	10 channels/second
			Slow Search:	1 channel/second
FREQUENCY COVERAGE:	VHF-Lo 30–50 MHz (in 5 kHz steps) Ham 144–148 MHz (in 5 kHz steps) VHF-Hi 148–174 MHz (in 5 kHz steps) Ham/Gov't. 430–450 MHz (in 12.5 kHz steps) UHF-Lo 450–470 MHz (in 12.5 kHz steps) UHF-Hi ("T") 470–512 MHz (in 12.5 kHz steps)		SCANNING RATE:	10 channels/second
			DELAY TIME:	2 seconds
			MODULATION ACCEPTANCE:	±7 kHz
CHANNELS OF OPERATION:	Any sixteen channels desired, plus Monitor channel, in any band combination		I.F. FREQUENCY:	10.7 MHz and 455 kHz
SENSITIVITY (for 20 dB Signal-to-Noise ratio):	30–50 MHz	0.5 μ V	FILTER:	1 crystal filter, 3 ceramic filters
	144–174 MHz	0.5 μ V	SQUELCH SENSITIVITY:	Threshold Less than 0.5 μ V Tight S/N 30 dB
	430–512 MHz	1.0 μ V	ANTENNA IMPEDANCE:	50 ohms
SPURIOUS REJECTION:	30–50 MHz	60 dB at 40 MHz	AUDIO POWER:	2 watts maximum
	144–174 MHz	60 dB at 160 MHz	BUILT-IN SPEAKER:	2½"x4" (6.5 x 10 cm) oval speaker
	430–512 MHz	50 dB at 480 MHz	POWER REQUIREMENTS:	AC – 120 volts, 60 Hz, 27 watts maximum DC – 12-15 volts Negative Ground only, 18 watts maximum
SELECTIVITY:	±9 kHz, -6 dB ±17 kHz, -50 dB		DIMENSIONS:	3-1/8 x 10-1/4 x 10-5/8" HWD (8 x 26 x 27 cm)
			WEIGHT:	8.16 lbs (3.7 kg)

PREPARATION FOR USE

Remove the screw from the Battery Compartment Cover and remove Cover; then snap in a 9-volt battery. (We recommend a Radio Shack long-life alkaline battery, 23-553 or equivalent.) Your PRO-2001 contains an electronic memory to preserve the 16 programmed scanner channels and the latest search range entered. The battery protects this memory during AC or DC power failure, or when you have the set unplugged.

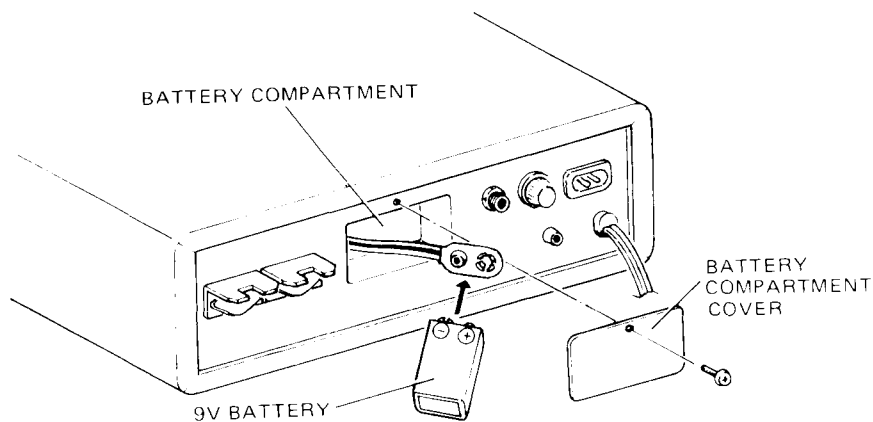

NOTE: To avoid loss of programmed memory, do not unplug AC or DC power cable when replacing battery. Replace battery at least every six months.

CAUTION—Never leave a weak or dead battery in your PRO-2001; even “leakproof” types can leak damaging chemicals.

Now you only need to do three things to be able to tune in on those exciting “monitor” frequencies:

1. Connect to a source of power—120 volts AC or 12 volts DC (see INSTALLATION, Page 11).
2. Connect an Antenna to the UHF and/or VHF Antenna jacks.
3. Program one or more frequencies into the scanner channel(s). (See Getting Started, Page 7.)

CONTROLS AND THEIR FUNCTIONS

A short description of the Controls is given here; for actual Operating Instructions, refer to Operation section, Page 7.

Channel Switches let you enable or disable each channel individually. When the button is in, Scanner will check that channel for activity. When the button is out, that channel is locked out and will be skipped during automatic or manual scan.

LED Indicators show which channel is being checked at any given moment. During scanning, LEDs will light up in sequence as each respective channel is checked for message activity. LEDs above locked-out channels will not light up.

OFF-VOLUME is the power switch and Volume control. When set is not in use, rotate this control counter-clockwise to turn it off.

SQUELCH control eliminates annoying background noise between signal transmissions. When properly set, SQUELCH will keep the PRO-2001 silent until a signal comes in on the channel(s) you are listening to—then, the Squelch circuit will “open” and you’ll hear the signal.

DELAY Switch holds the Scanner on an active channel for two seconds after a transmission has ended. If there is no reply within that time, scanning resumes. With switch in OFF position, scanning resumes as soon as message has ended.

Scanning Switch determines the Scanner function. In AUTO position, Scanner automatically checks each enabled channel for activity. In stop (middle) position, Scanner remains on one channel, whether or not there is a message coming in on that channel. Press the switch momentarily to MANUAL position to advance Scanner to next enabled channel.

Frequency Display shows exactly which frequency is being scanned, monitored or programmed into memory.

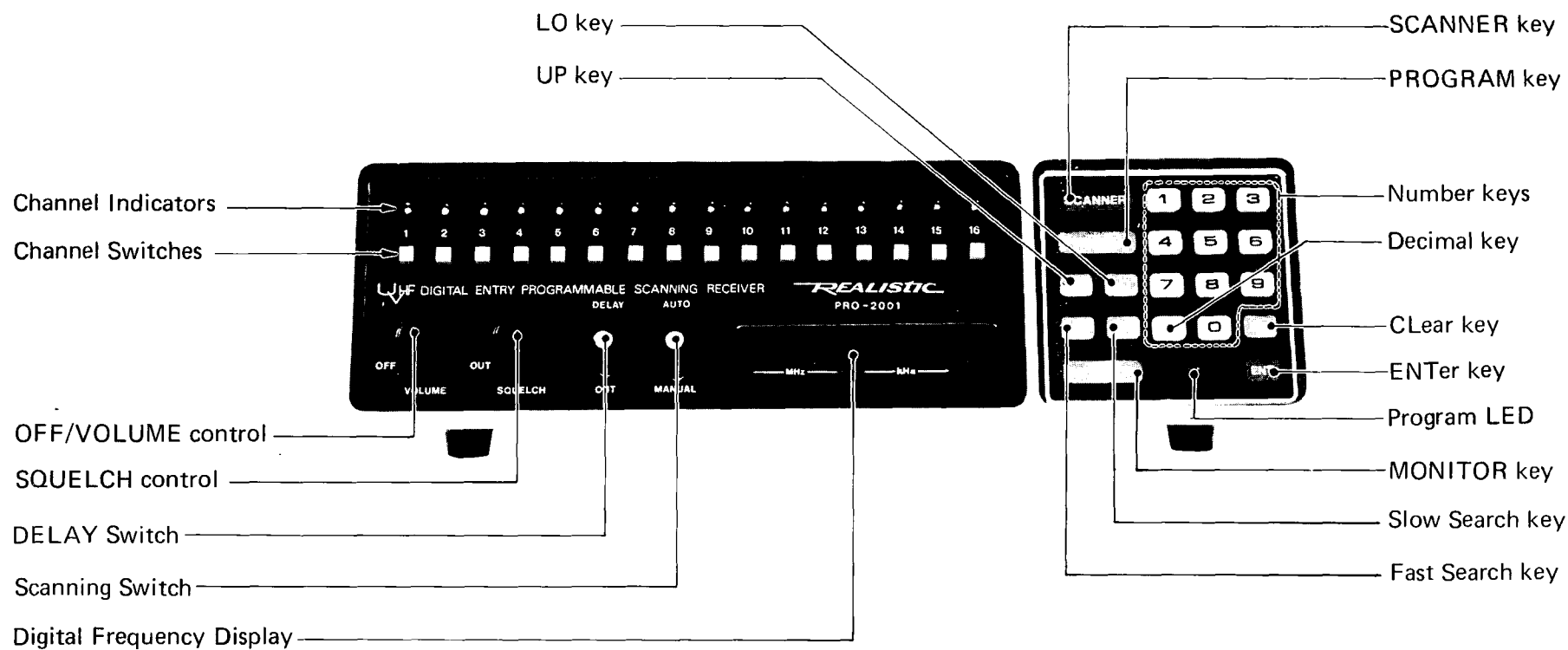

SCANNER key sets the PRO-2001 to function as a Scanner.

PROGRAM key sets the PRO-2001's Microprocessor for Program Entry.

UP **LO** (UPper & LOwer) keys are for setting the frequency range when using the Search feature. Use UP to set the upper frequency limit for Searching and use LO to set the lower frequency limit.

FS **SS** (Fast Search & Slow Search) keys are for setting the speed of Searching. FS provides a Search speed of about 10 frequencies per second and SS provides a Search speed of about 1 frequency per second.

ENT (ENTer) key enters a displayed frequency into any one of the 16 channels you may select.

MONITOR key has a dual function: to monitor a frequency you've just entered (programmed) or to hold a frequency you find while searching and to put that frequency into the Monitor Memory. This is the 17th channel we've mentioned earlier (in addition to the 16 available with the Channel Switches).

1 **2** **3** **Number keys**—enter the desired frequency. Use these **4** **5** **6** for programming a frequency to be entered or for **7** **8** **9** setting up the limits for the Search mode. **.** **0**

CL (CLear) key clears the Frequency Display (example, to correct an error in program entry).

☼ **Program LED** tells you when the PRO-2001 is ready for program entry (lights when you press PROGRAM key).

REAR PANEL

UHF ANTENNA Jack—connect an antenna to this jack for UHF reception. Use an antenna such as Radio Shack Catalog Number 20-451 (indoor operation).

VHF ANTENNA Jack—for VHF reception, connect an antenna to this jack. Use an antenna such as Catalog Number 20-161 (indoor operation).

Battery Compartment—load a 9-volt battery into this compartment to avoid loss of programmed memory when set is unplugged.

EXtERnAL SPeAKeR Jack is for connecting an external speaker or a headphone. Use it for private listening, or in areas where background noise is excessive (in factories, at the scene of an accident or fire, in a vehicle, etc.). If you want a remote speaker, plug it in here. Connecting a plug to this jack automatically disconnects the internal speaker.

FUSE—is to protect your PRO-2001 from an overload in the power circuit. Replace only with a 1 Amp fuse.

DC 13.8V Jack is for connecting an external source of 12 volts DC, negative ground. This will permit you to use the PRO-2001 in a vehicle or boat.

TAPE OUT Jack—for recording “off-the-air”. Connect your tape recorder directly to this jack.

Line Cord—for AC operation; plug into a source of 120 volts, 60 Hz, AC power.

Mounting Bracket—a universal type bracket is provided for quick and easy installation in a vehicle or boat, or for permanent installation as a base station.

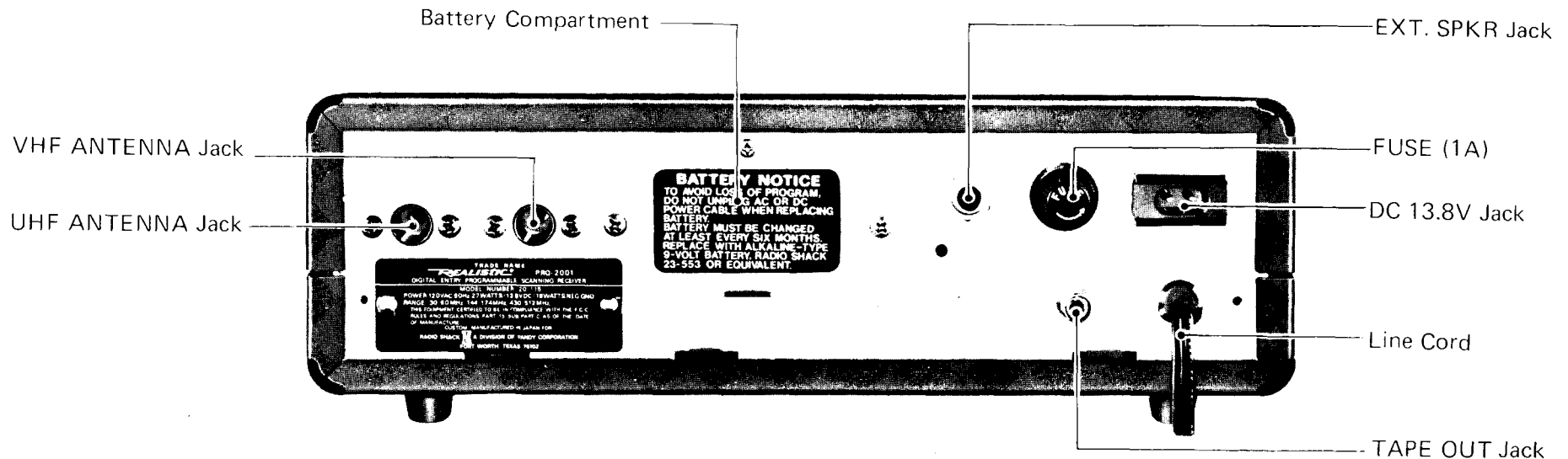

OPERATION

When you have completed **Preparation For Use** (Page 4), you are ready to operate your Receiver. To help you start enjoying the PRO-2001 right away—and also make sure you take advantage of all its fantastic capabilities, we've divided these instructions into four sections: **Getting Started**, **Normal Scanning**, **More on Programming** and **Search Mode**.

GETTING STARTED

Turn **VOLUME** "on" by rotating clockwise about 1/4-turn.

Press **SCANNER** key.

Rotate **SQUELCH** fully counterclockwise.

Press in all the Channel Switches.

You should hear a rushing sound from the Speaker. Now adjust **SQUELCH** clockwise until you no longer hear the rushing background noise (further explanation of **SQUELCH** adjustment is noted later).

To enter a frequency: let's use one of the National Weather Service frequencies (162.55, 162.40 or 162.475 MHz) as an example, since you can pick up at least one of these in most parts of the country.

1. Select the channel you wish to program. Press Scanning Switch momentarily to **MANUAL** position to advance Scanner to next channel; repeat until desired channel is reached.
2. Press **PROGRAM** button. Program LED will light up.
3. Using the calculator-type keyboard, enter desired frequency (in this case 162.55), as follows:

1	—	6	—	2	—	•	—	5	—	5
---	---	---	---	---	---	---	---	---	---	---
4. Press **MONITOR** and you should hear the station. If nothing is heard, press **CLear** and repeat Steps 3 and 4 with either 162.40 or 162.475. If you don't need to check the frequency, you can skip this step.
5. Press **ENTer**. Frequency is now stored in the channel which has a glowing LED indicator.
6. Press **SCANNER** to return to normal scanning mode.

You can enter up to 16 different frequencies into the Scanner by following this same procedure. To locate additional frequencies active in your area, and to find out more about keyboard functions, refer to **Programming** and **Search Mode** sections below.

NORMAL SCANNING

If you want your Scanner to continuously scan the channels for which you have frequencies programmed, you must adjust **SQUELCH** as instructed above, then set the Scanning Switch to the **AUTO** position. The PRO-2001 will constantly scan each channel in sequence; when a signal appears on one of the channels, the Receiver will lock onto that channel and you will hear the signal. Frequency being monitored will be displayed in seven-digit LED display.

If you do not want automatic scanning on one or more channels, press their Channel Switch Buttons "off" (press in to release the button so it pops out).

If you want to stay tuned to one channel only, set the Scanning Switch to the center position (stops scanning) and then press momentarily to the **MANUAL** position to advance to the channel you want to listen to (as indicated by a Channel LED).

For Manual scanning, the Receiver can be either "squelched" or "unsquelched"; for **Automatic scanning**, **SQUELCH** must be set to **eliminate the background noise**.

To eliminate the annoying background noise, rotate **SQUELCH** clockwise until the background noise just stops. You can't adjust **SQUELCH** properly while listening to a station, so wait till signals cease. If you set **SQUELCH** as noted above, the Receiver will appear "dead" until a signal comes in; when a signal comes in, the Squelch circuit "opens up" and you hear the signal. When the signal ceases, the Squelch circuit "closes" and cuts out all sound until the next signal comes in.

The PRO-2001 has a switchable Scan **DELAY** which virtually eliminates missed replies. The circuit "waits" on the channel you are monitoring for two seconds after a message has ended; if no further message is received by then, scanning is resumed. **DELAY** functions in **AUTO** scanning mode and **Search mode** (see Page 9).

MORE ON PROGRAMMING

Pressing **PROGRAM** key puts Receiver in the programming mode; the LED indicator on the keyboard stays lit while in this mode. Programming keys are active only while this LED is lit.

NOTE: When you press **PROGRAM**, display will show whatever frequency (if any) is stored on the channel the scanner is on. You can ignore these numbers, because they'll disappear as soon as you start entering the desired frequency.

Valid Frequency

You can enter any frequency into the memory of your PRO-2001 within the six bands specified under Frequency Coverage (Page 3). However, you should realize that the programmable frequencies are in 5 kHz steps in the 30~50/144~174 MHz range, and in 12.5 kHz steps in the 430~512 MHz range. If you try to enter an "in-between" frequency, the next valid and lower frequency will be entered or programmed. Example: if you try to enter 161.9102, the closest lower frequency that's valid, 161.9100, will be entered.

If you try to enter a frequency which is outside the six-band tuning range, "Error" will be displayed. To clear an Error display, press **CLear** key.

Frequency Display

The seven digit display lets you know what's going on at all times. It's especially important when you're entering a frequency, as it lets you check to see that you entered the correct key sequence. Press **CLear** to clear display in case you do key in the wrong frequency.

Entering a Frequency

To enter a known frequency, follow Steps 1~6 on page 7. You may skip Step 4 if you do not need to check the channel for activity. Note that the frequency you enter will be stored on whichever

channel has a glowing LED, and the previously stored frequency will be erased. To change channels, you must return to scanning mode by pressing **SCANNER**.

Whenever an Error condition is indicated on the display, press **CLear** and repeat Steps 3~6 exactly. Be sure that the desired frequency is within one of the six bands.

USE OF THE MONITOR KEY

The **MONITOR** key lets you check a frequency for activity without actually storing it in one of the 16 channels. Just push **PROGRAM** Key, enter the desired frequency and press **MONITOR**. You can now listen to this frequency for as long as you like—without disturbing any of the frequencies stored in the scanner!

But that's just the beginning. You can also return to the scanning mode (press **SCANNER**), listen to any or all of the 16 channels there—and then return to the channel you placed in the Monitor memory. Just press **PROGRAM** and **MONITOR** and you're back on this "17th channel".

Unlike the 16 scanner channels, the Monitor memory is NOT retained when the set is turned off.

For additional uses of **MONITOR** key, see **Search Mode** section on Page 9.

LIMITS OF OPERATIONAL FREQUENCIES

The six-band tuning range of your PRO-2001 is permanently stored in the Receiver's integrated-circuit microprocessor. As such, it cannot be extended or altered in any way, even by a skilled electronics technician. So if you try to monitor or enter an out-of-band frequency—you'll get the Error message every time! To listen in on CB, SW, lower Ham bands, etc., you'll just have to get another receiver designed for that purpose (like our famous DX-160 tunable receiver).

SEARCH MODE

You can locate the frequency for any unknown station in the VHF/UHF bands by using the Search Function of your PRO-2001.

1. Press **SCANNER** key to select a channel. (Momentarily press the Scanning Switch to **MANUAL** to advance to a desired channel as indicated by the Channel LED.)
2. Set **SQUELCH** control to point where annoying background noise just stops.
3. Press **PROGRAM** key. (The Program LED will come on.)
4. Press **LO** key; then press the numbers for the lower frequency limit you desire.
5. Press **UP** key; then press the numbers for the upper frequency limit you desire.

NOTE: You can set upper and lower Search limits in different bands if you like. For example, you can set the lower limit to 40 MHz (in VHF Lo band) and upper limit to 470 MHz (in the UHF band). In such a case, those frequencies outside of the specified tuning range will just be skipped.

6. Then, press **FS** (Fast Search) or **SS** (Slow Search) key to start Search. You can change searching speed any time by pressing either the **FS** or **SS** key.
7. When a signal comes in on a frequency between the upper and lower frequencies you have set, Search stops and the frequency will be held until its signal ends. (If **DELAY** is "on", frequency will be held for two seconds after signal ends.)

8. To continue monitoring a frequency you have "discovered", press **MONITOR**. This halts the search, stores the frequency in the in the Monitor Memory, and lets you "listen in" for a while.
9. To enter this frequency into the channel you selected in Step 1, press **ENTER**. (You may skip this step if you just wish to monitor temporarily.)
10. To resume search where you left off, press **FS** or **SS**. To start search over at lower frequency limit, press **UP** and **LO** keys and then **FS** or **SS**.

NOTE: You can return to a channel stored in the Monitor Memory by pressing **CLear** and then **MONITOR**.

11. When another active frequency is encountered in the search, the Scanner will hold on this frequency as described in Step 7. If you want to stay tuned to this frequency, press **MONITOR**. The new frequency will now replace the contents of the Monitor Memory.
12. To enter this new frequency into a channel other than the one selected in Step 1, press **SCANNER** key and use **MANUAL** selector to advance to desired channel. Press **PROGRAM** to return to programming mode. Press **MONITOR** to recall the frequency stored there. Now press **ENTER** key to put that frequency into the channel memory.

Continue the process until you've identified the frequencies that interest you in that search range. To change the upper and lower limits, just enter new ones as described in Steps 4 and 5. The last-entered search limits are retained in memory, even when the set is unplugged.

NOTE: To halt a search at any time, press **MONITOR** key. This will also place displayed frequency into Monitor Memory.

A SAMPLE SEARCH ROUTINE

Search Range : 162~165 MHz

1. Press **SCANNER**. Advance to the channel into which you wish to make entry by momentarily pressing the Scanning Switch to **MANUAL**.
2. Set **SQUELCH** control to point where annoying background noise just stops.
3. Press **PROGRAM** key.
4. Press **LO** key and the numbers 1, 6, 2 to set the lower limit.
5. Press **UP** key and numbers 1, 6, 5 to set the upper limit.
6. Press **FS** or **SS** key to start Search at desired scanning speed.
7. If Search stops at 162.40 MHz, you have identified the National Weather Service station.
8. Press **MONITOR** key to hold this station for Monitoring.
9. Press **ENTER** key to enter the displayed frequency (162.40 MHz).
10. To restart Search, press **FS** or **SS** key.
11. Again you may locate a new station and Search will stop. If the frequency is 162.55 MHz, you've identified another National Weather Service station.
12. Press **MONITOR** key if you desire to temporarily monitor this station.
13. If you wish to enter this frequency into a Channel memory, press **SCANNER** key and then use the Scanning Switch to select the channel into which you want to enter this frequency. Press **PROGRAM**, then **MONITOR** and **ENTER** keys.

BIRDIES

Some frequencies may be difficult or impossible to receive. If the Scanner locks up on one of these frequencies while in the Search mode (or if you program-in one of them), you may only hear noise. These "birdies" are the products of internally generated signals mixing with external signals like TV and FM broadcasts. Plug-in antennas are much more likely to pick up these undesirable signals—that's another good reason for getting an outdoor, base-station type antenna for home installations.

If the interference is not severe, you may be able to use **SQUELCH** to cut out such annoying birdies.

A few of the most common birdies to watch out for are listed below.

30.735 MHz	469.0250 MHz
32.095	469.0375
32.100	469.0625
32.105	469.0750
33.880	469.0850
33.885	469.1000
35.825	469.1125
40.980	469.1500
42.790	469.2375
42.795	469.2500
42.800	469.2750
42.805	469.2875
42.810	469.4250
45.605	469.4625
163.660	469.4750

INSTALLATION

You only need two things to start enjoying your PRO-2001: a UHF and/or VHF antenna and a source of power, either 120 volts AC or 12 volts DC negative ground. Whether you plan to use your Receiver at home or in a mobile installation, the choice of a proper antenna is of utmost importance. A variety of suitable antennas are described below, and all are available at your local Radio Shack.

BASE INSTALLATION

The very simplest way to use your PRO-2001 at home is with indoor plug-in antennas, one for VHF Hi/Lo and one for UHF. For some frequencies, indoor antennas are perfectly adequate. However, for top reception of all frequencies you may be interested in, you'll want an external, base-station antenna. Be sure to use RG 58/U coaxial cable for maximum transfer of the tiny radio signals.

The only other thing you need to do is connect the line cord to a source of 120 volts, 60 Hz, AC power.

Base Antennas

For superior UHF/VHF reception, use our UHF-Hi/Lo, VHF-Hi Ground Plane, 20-176, with a signal splitter to run coaxial cable to both UHF and VHF jacks on rear panel of your Receiver.

Convenient indoor antennas: VHF-Hi/Lo Plug-In, 20-161; and UHF-Hi/Lo Plug-In, 20-451.

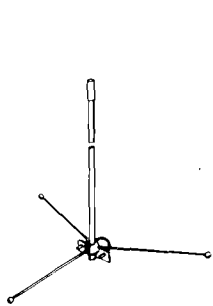

20-176



20-161



20-451

MOBILE INSTALLATION

Safety and operating convenience are the primary factors to consider when you install any equipment in a vehicle. Be sure you can easily reach the Receiver's controls. Also, be sure the connecting cables do not interfere with the operation of the vehicle (brake, accelerator, etc.).

You can mount the Receiver to the underside of the dash or instrument panel in the vehicle or boat. Use the universal mounting bracket provided. Take care when drilling holes that you do not drill into existing wires or trim.

The PRO-2001 is designed to operate from a negative ground 12-volt DC source. Be sure you connect power leads with the correct polarity. Use the DC Power cable provided. The other end of these wires (red and black) can be connected to an Auto Cigarette Lighter Plug, Catalog Number 274-331; or you can make the connections directly to the fuse block of the vehicle or boat. Be sure to observe correct voltage polarity: red to "+" and black to "-".

IMPORTANT: If your car has been burning out headlamps and other bulbs at a rapid rate, first have the voltage regulator checked for proper output: excessive voltage (more than 16 volts) can damage your Receiver.

NOTE FOR MOBILE INSTALLATION:

If for some reason you are unable to connect power to an accessory terminal (This is the best place to make connection), it is possible that after starting a vehicle's engine, the PRO-2001's displayed frequency (and channel LED) may light at random — ie. no relation to frequency stored in memory. This is normal; to return to normal frequency and memory operation, turn Scanner's power off and on.

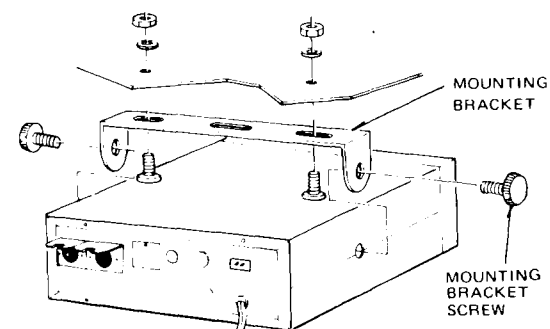

Mobile Antenna

There are many possible mounting locations on a car. Three of the most popular locations for monitor antennas are shown below.

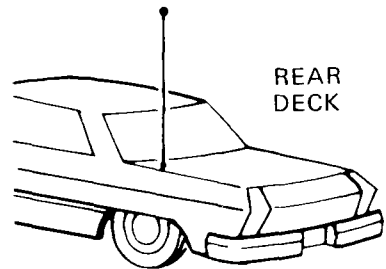
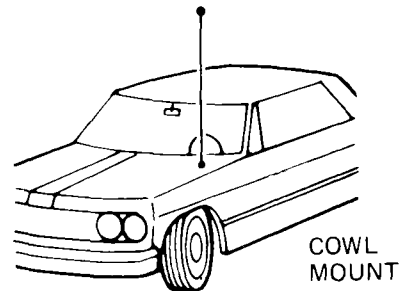
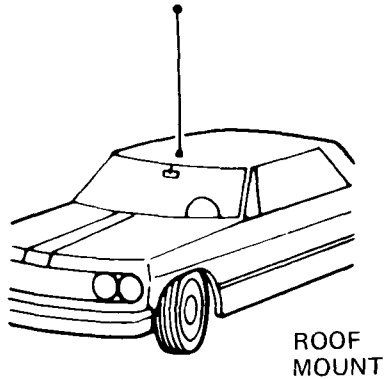

A convenient and efficient antenna for mobile use is Radio Shack's VHF-Hi/Lo UHF-Hi/Lo No-Hole Trunk Mount Mobile, 20-017.

Keep the following points in mind when installing your mobile antenna.

1. Mount it rigidly, so it will remain vertical while in motion.
2. Mount as far as possible from the engine compartment.



20-017

MOBILE NOISE SUPPRESSION

Your PRO-2001 is a very sensitive receiver, and will pick up even extremely weak signals. This means that in addition to the tiny radio signals, radio-frequency noise may also be picked up and amplified.

In a mobile installation, it is important that you take steps to reduce the amount of noise that finds its way into the Receiver. If you take some or all of the steps recommended below, your reception should be quite satisfactory for mobile applications.

Electrical System :

Generally speaking, noise can be generated by any device or connection that carries electrical current. Any device that generates a spark should also be suspected. Bypass any suspected wire to ground with a high quality $1\mu\text{F}$ coaxial capacitor.

A very common source of noise is the generator or alternator. This type of noise will sound like a musical whine, and will also vary with speed of the engine. Generator and alternator noise can usually be reduced by connecting a coaxial-type capacitor from the armature terminal to the metal case.

Ignition System :

The ignition system is the most common source of noise. This noise can be identified by the fact that its speed varies with the engine speed. Ignition noise will sound like a series of "popping" sounds, while the engine is idling, and will speed up to a buzzing sound as engine speed is increased.

There are a number of things that can be done for this type of noise.

1. Use radio suppression-type ignition wire and resistor spark plugs.
2. Check high-voltage wiring for leakage, cracks, etc. Replace any old wiring.
3. In extreme cases, obtain an ignition noise suppression kit—it should shield all ignition wiring. This will provide maximum noise suppression.

ACCESSORIES



279-200

A pair of headphones can be a very useful accessory. In areas where a high noise level is present (in a factory, at the scene of a fire or accident, etc.), or when you want to listen privately, use headphones. Your Radio Shack store has a couple of very fine selections for your PRO-2001. Just plug them into the rear panel **EXT SPKR** jack.

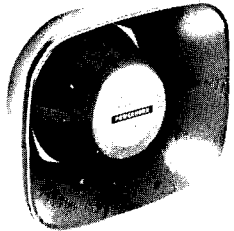

40-1244

If you want to listen to the Receiver from a remote position, or just want to use an external speaker, connect it to the **EXT SPKR** jack. We recommend Radio Shack's 40-1244, a weatherized, rugged 4" (10 cm) Speaker. Or better still, our 21-549, which comes with a bracket—it is uniquely suited for this type of application.

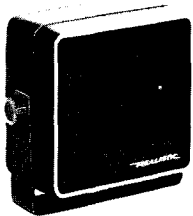

21-549

You can record off-the-air using a tape recorder connected to the **TAPE OUT** jack on the rear.

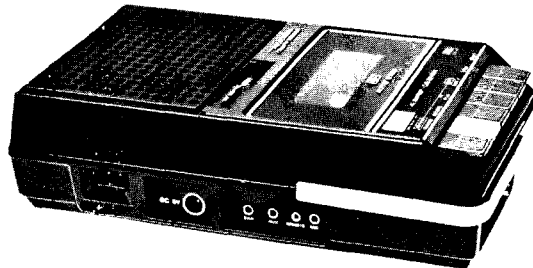

14-841

MAINTENANCE

The **PRO-2001** is a ruggedly built electronic unit, with all parts conservatively rated. However, you should treat it with care; don't subject it to excessively rough handling. You will find it will give you long life if kept free from dirt and excessive humidity.

The 9-volt Battery (used to maintain the program memory) should be replaced every six months. Use only an Alkaline type, such as Radio Shack's Catalog Number 23-553 (replace only when the **AC line cord** is connected).

If You Have Problems

We hope you don't; but if you do, here are some suggestions.

Problem	Possible Cause
Inoperative	No power—check to see that unit is plugged in to a working AC outlet. If using 12-volt DC negative ground power, try using AC power to isolate problem. Also check AC and DC fuses. Replace only with 1 amp. fuses.
Will not scan or search	Improper squelch setting—turn SQUELCH control clockwise to slightly past point where rushing sound ceases (while no signal is present).
Won't receive on certain frequencies	Check to see that UHF and/or VHF antennas are connected to proper jacks.
Scan or search locks-in on frequencies where no clear signal is present	"Birdies"—see page 10.

If none of these suggested remedies solves the problem, return your set to your nearby Radio Shack. It will be repaired by a qualified technician and you'll have it back ASAP!

GUIDE TO THE ACTION BANDS

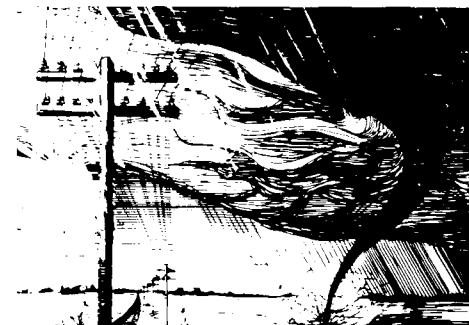
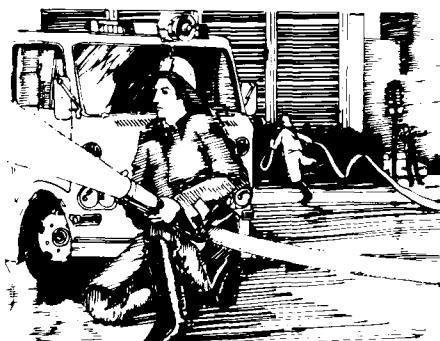
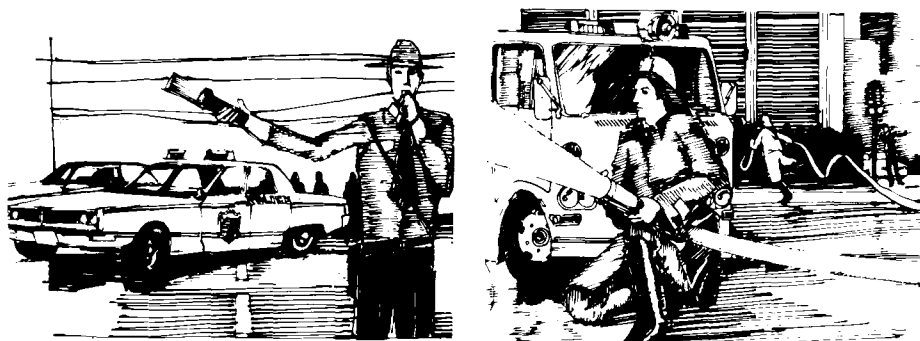

Your community is alive with action—action which is constantly being reported on the air waves. Your **PRO-2001** will automatically scan the air waves to bring you that action—your police force at work, a fire truck on a mission, Sheriff's department, State police, the National Weather Service, Ham Radio operators, highway and other emergency-type services, some industrial services, some transportation services (taxi, trucks, railroad), plus some Government services.

Lots of things are going on that most of us just are never aware of. But, with the right frequencies programmed into your **PRO-2001**, you can monitor such exciting signals. You'll have to do a little investigating in your community to find out what services are active and on what frequencies. Or better still, just use the Search capabilities of your Scanner—and it will tell you what frequencies are used! You will find one of our books to be very interesting and helpful in this area: *REALISTIC GUIDE TO POLICE, FIRE AND AIRCRAFT RADIO*.

What to listen for and where? That is a little difficult for a specific answer. Each area of the country can and will use different channels. All we can do is give you some general pointers and then let you take it from there.

Find out if there is a local club which monitors these frequencies. Often a local electronics repair shop that does work on the equipment can give you the channel frequencies used by local radio services. A volunteer police or fire employee can also be a good source of this information.

An interesting service is the Mobile Telephone. FCC has assigned this service channels in the range of 152.51 to 152.81 MHz at every 0.030 MHz (channels are 30 kHz apart). Also, 454.375 to 454.95 MHz with channels 25 kHz apart from 454.375 to 454.625 and then every 50 kHz up to 454.95.

As a general rule on VHF, most activity will be concentrated between 153.785 and 155.98 and then again from 158.73 to 159.46 MHz. Here you'll find local government, police, fire and most such emergency services. If you are near a railroad yard or major railroad tracks, look around 160.0 to 161.9 for them.

In some of the larger cities, there has been a move to the UHF bands for these emergency services. Here, most of the activity is in a spread of 453.025–453.95 and again at 456.025–459.95 MHz.

In the UHF band, the overall spread of 456.025–459.95 and again at 465.025–469.975 MHz is used by mobile units and control stations associated with base and repeater units which operate 5 MHz lower (that is, 451.025–454.95 and 460.025–464.975 MHz). This means that if you find an active channel inside one of these spreads, you can look 5 MHz lower (or higher as the case may be) to find the major base station/repeater for that radio service.

A handy book to have is the *POLICE CALL RADIO DIRECTORY* for your region. Stop by your local Radio Shack store and ask about it. It has complete listings, by frequency, of the various radio services in the bands covered by your **PRO-2001**. These Directories are updated every year, so get a current one.

TYPICAL BAND USAGE

The following is an abbreviated listing of what's going on in the frequency ranges your PRO-2001 can receive—it'll help you decide which ranges you'd like to search. For explanation of abbreviations used, see page 17.

30 ~ 50 MHz Band (0.020 MHz or 20 kHz spacing)

30.01 ~ 30.56	Govt.
30.56 ~ 30.62	Sp. Ind.
30.66 ~ 31.24	Ind. (Pet., For. Cons., Bus., For. Prod.)
31.26 ~ 31.98	Sp. Ind., For. Cons.
32.00 ~ 33.00	Govt.
33.02 ~ 33.16	Hwy., Sp. Emer., Bus.
33.18 ~ 33.38	Pet.
33.42 ~ 33.98	F.D.
34.00 ~ 35.00	Govt.
35.02 ~ 35.18	Bus.
35.22 ~ 35.66	Mob. Tel. & Page
35.70 ~ 35.72	Bus.
35.74 ~ 35.98	Sp. Ind. & Bus.
36.00 ~ 37.00	Govt.
37.02 ~ 37.44	P.D. & L. Govt.
37.46 ~ 37.86	Power
37.90 ~ 37.98	Hwy. & Sp. Emer.
38.00 ~ 39.00	Govt.
39.02 ~ 39.98	P.D., L. Govt.
40.00 ~ 42.00	Govt.
42.02 ~ 42.94	St. P.D.
42.96 ~ 43.18	Sp. Ind. & Bus.
43.22 ~ 43.68	Mob. Tel. Page
43.70 ~ 44.60	Trucks, Bus.
44.62 ~ 45.06	St. P.D., For. Cons.
45.08 ~ 45.66	P.D.
45.68 ~ 46.04	P.D. Hwy., Sp. Emer.
46.06 ~ 46.50	F.D.
46.52 ~ 46.58	L. Govt.
46.60 ~ 47.00	Govt.
47.02 ~ 47.40	St. Hwy.
47.42	Red Cross
47.44 ~ 47.68	Sp. Ind., Sp. Emer.
47.70 ~ 48.54	Power
48.56 ~ 49.58	For. Prod., Pet.
49.60 ~ 50.00	Govt.

144 ~ 148 MHz 2 Meter Amateur (Ham) Band

148 ~ 174 MHz Band Mixed Spacing (15, 20, 25 kHz)

148.010 ~	MARS
148.15 ~	CAP
148.155 ~ 148.250	MIL
148.290 ~ 150.750	USN
150.815 ~ 150.995	Bus.
151.010 ~ 151.130	Hwy.
151.145 ~ 151.475	For. Cons.
151.505 ~ 151.595	Sp. Ind.
151.625 ~ 151.955	Bus.
151.985 ~ 152.240	Mob. Tel. (RCC)
152.270 ~ 152.450	Taxi
152.480 ~ 152.840	Mob. Tel. Page
152.870 ~ 153.020	Sp. Ind., Mot. P.
153.050 ~ 153.440	Pet., For. Prod.
153.470 ~ 153.710	Power
153.740 ~ 154.115	L. Govt.
154.130 ~ 154.445	F.D.
154.450 ~ 154.600	Sp. Ind., Pet., Bus.
154.655 ~ 155.145	P.D., L. Govt., St. P.D.
155.160 ~ 155.400	Sp. Emer., P.D.
155.415 ~ 156.030	P.D., L. Govt.
156.045 ~ 156.240	Hwy., P.D.
156.275 ~ 157.425	Marine
157.456 ~ 157.500	Auto Emer.
157.530 ~ 157.710	Taxi
157.740 ~ 158.100	Mob. Tel., Page
158.130 ~ 158.460	Power, For. Prod., Pet.
158.490 ~ 158.700	Mob. Tel. (RCC)
158.730 ~ 158.970	P.D., L. Govt.
158.985 ~ 159.210	P.D. Hwy.
159.225 ~ 159.465	For. Cons.
159.510 ~ 160.200	Trucks
160.215 ~ 161.565	R.R.
161.600 ~ 162.000	Marine
162.026 ~ 162.175	Bur. Recl.
162.400	U.S.W.B.
162.550	U.S.W.B.
163.125 ~	Indian Affairs
163.175 ~	Bur. Recl.
163.275	U.S.W.B.

163.388 ~ 163.538	MIL
163.825 ~ 163.975	Govt.
164.025 ~ 164.075	U.S.C.G.S.
164.175 ~ 165.188	Bur. Recl., Nat. Pk., Govt., Agr. & For.
169.300	F.A.A.
169.450 ~ 169.725	Ind., Data
170.150	F.D., BC. R.
170.200 ~ 170.220	U.S.C.G.S.
170.225 ~ 170.325	Ind., Land Tr.
170.425 ~ 170.575	For. Cons.
170.975 ~ 171.250	Govt. Ind., Land Tr.
171.388 ~ 172.725	Bur. Recl., For. Cons., Ind., Dept. Ag. & For., Govt.
172.775	Nat. Pk.
173.025	U.S.W.B.
173.075	U.S.C.G.S.
173.204 ~	Press Relay, Mot. P., Pet., Bur. Recl.

430 ~ 450 MHz Amateur (Ham) Band

450 ~ 512 MHz Band (25 kHz Spacing)

450.050 ~ 450.950	BC. R.
451.000 ~ 451.150	Util.
451.175 ~ 451.750	For. Prod., Pet., Pwr., Tel. Maint
451.775 ~ 451.975	Spec. Ind.
452.000 ~ 452.500	Taxi, Mot. Carrier, R.R.
452.525 ~ 452.600	Auto Club
452.625 ~ 452.975	Motor Carr., R.R.
453.000 ~ 453.975	L. Govt., P.D., F.D.
454.000 ~ 454.975	Mob. Tel.
455.000 ~ 455.975	Remote Br.
456.000 ~ 458.975	P.D., F.D., Ind., Lan. Tr.
459.000 ~ 459.975	Domestic Public
460.000 ~ 460.625	P.D., F.D.
460.650 ~ 462.175	Bus.
462.200 ~ 462.450	Taxi
462.750 ~ 462.975	Bus.
463.000 ~ 463.175	Medical
463.200 ~ 464.975	Bus.
465.000 ~ 467.500	P.D., F.D., Ind., Land Tr.
467.750 ~ 467.925	Bus.
467.7375 ~ 469.975	Pub. Safety, Ind., Land Tr.

In some large metropolitan areas, 1 or 2 channels of the "TV Band" (470 MHz to 512 MHz) are used for special communications. Each station (channels 14 through 20) uses 6 MHz:

470 ~ 476	T.V. Channel 14
476 ~ 482	T.V. Channel 15
482 ~ 488	T.V. Channel 16
488 ~ 494	T.V. Channel 17
494 ~ 500	T.V. Channel 18
500 ~ 506	T.V. Channel 19
506 ~ 512	T.V. Channel 20

Where these frequencies are assigned for special communications, in lieu of a T.V. station, the 6 MHz segment is allocated as shown here for channel 14 (470 ~ 476 MHz).

470.0125 ~ 470.2875	Domestic Public, (Base, Mob.)
470.3125 ~ 471.1375	Public Safety
471.1625 ~ 471.2875	Reserve Pool A
471.3125 ~ 471.4125	Pwr., Tel. Maint.
471.4375 ~ 471.6375	Spec. Ind.
471.6625 ~ 471.7875	Reserve Pool B
471.8125 ~ 472.3375	Bus.
472.3625 ~ 472.4375	Taxi
472.4675 ~ 472.7875	R.R., Motor Carrier, Auto Emer.
472.8125 ~ 472.9875	Pet., For. Prod., Mfg.
473.0125 ~ 473.2875	Domestic Public
473.3125 ~ 474.1375	Public Safety
474.1625 ~ 474.2875	Reserve Pool A
474.3125 ~ 474.4125	Pwr., Tel. Maint.
474.4375 ~ 474.6375	Spec. Ind. (Mobile)
474.6625 ~ 474.7875	Reserve Pool B.
474.8125 ~ 475.3375	Bus.
475.3625 ~ 475.4375	Taxi
475.4625 ~ 475.7875	R.R., Motor Carrier, Auto Emer.
475.8125 ~ 475.9875	Pet., For. Prod., Mfg.

The same allocation pattern is repeated for each of the TV channels 14 thru 20. For example, if channel 17 is assigned for communications in your area, "Taxi" would be 490.3625 to 480.4375 and 493.3625 to 493.4375 (corresponding to 472.3625 to 472.4375 and 475.3625 to 475.4375 above). Note that in the example, we added three TV channels (18 MHz) to the channel 14 frequencies.

BLOCK DIAGRAM

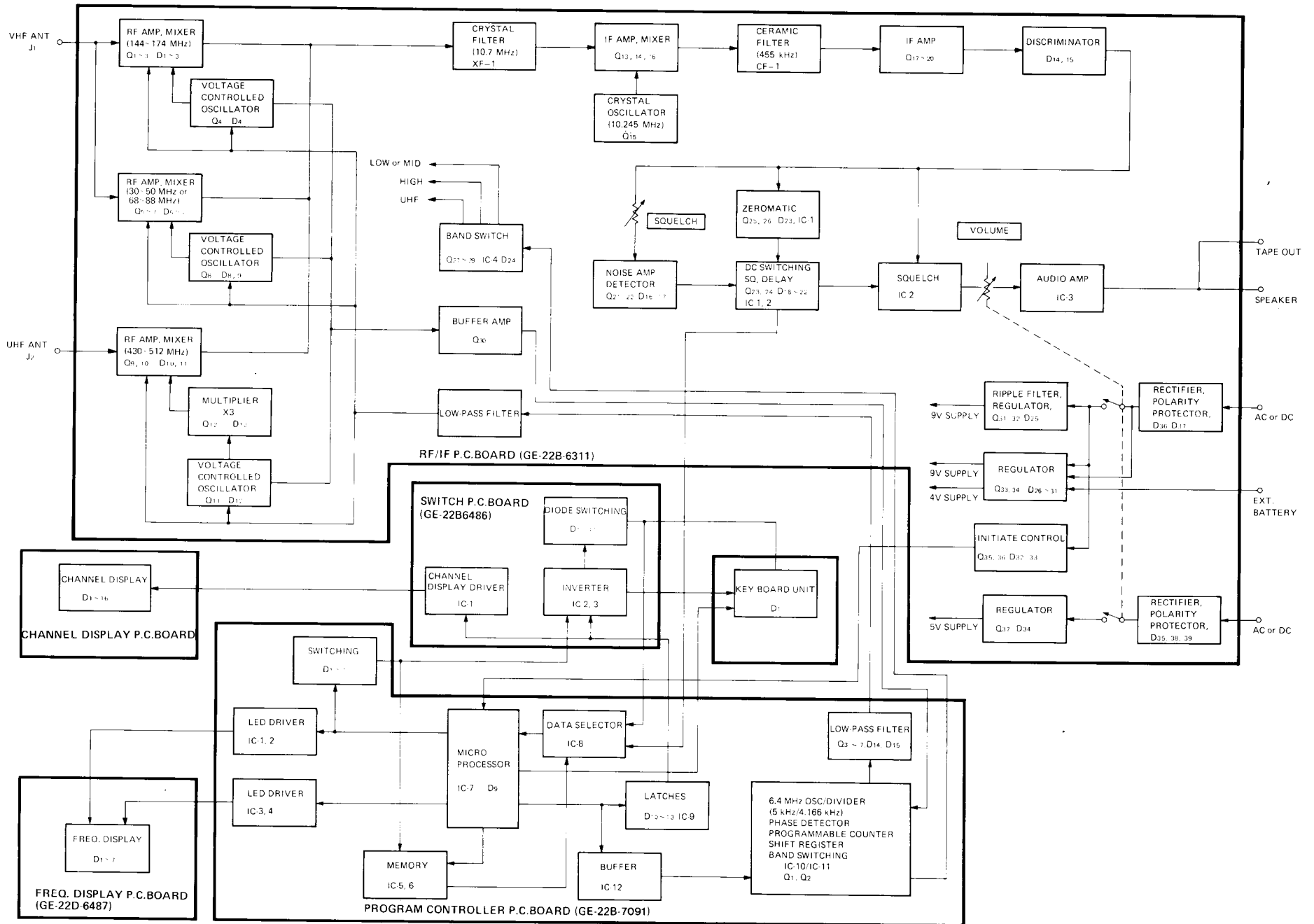

BLOCK DIAGRAM

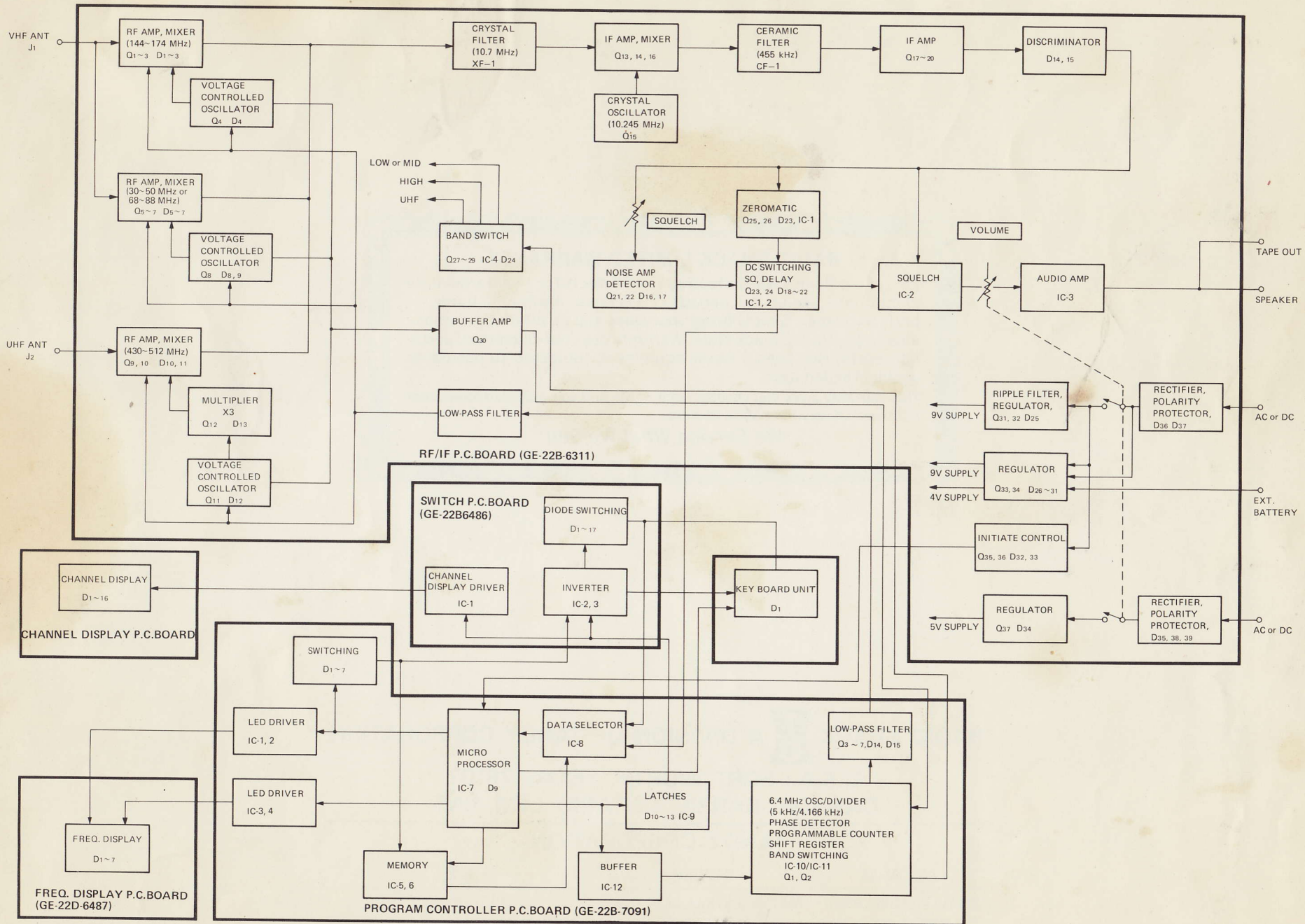

RADIO SHACK LIMITED WARRANTY

This equipment is warranted against defects for 1 year from date of purchase. Within this period, we will repair it without charge for parts and labor. Simply **bring your sales slip** as proof of purchase date to any Radio Shack store. Warranty does not cover transportation costs. Nor does it cover equipment subjected to misuse or accidental damage.

This Warranty gives you specific legal rights and you may also have other rights which vary from state to state.

We Service What We Sell

RADIO SHACK  **A DIVISION OF TANDY CORPORATION**

U.S.A.: FORT WORTH, TEXAS 76102
CANADA: BARRIE, ONTARIO L4M 4W5

TANDY CORPORATION

AUSTRALIA	BELGIUM	U. K.
280-316 VICTORIA ROAD RYDALMERE. N.S.W. 2116	PARC INDUSTRIEL DE NANINNE 5140 NANINNE	BILSTON ROAD WEDNESBURY, WEST MIDLANS WS10 7JN