

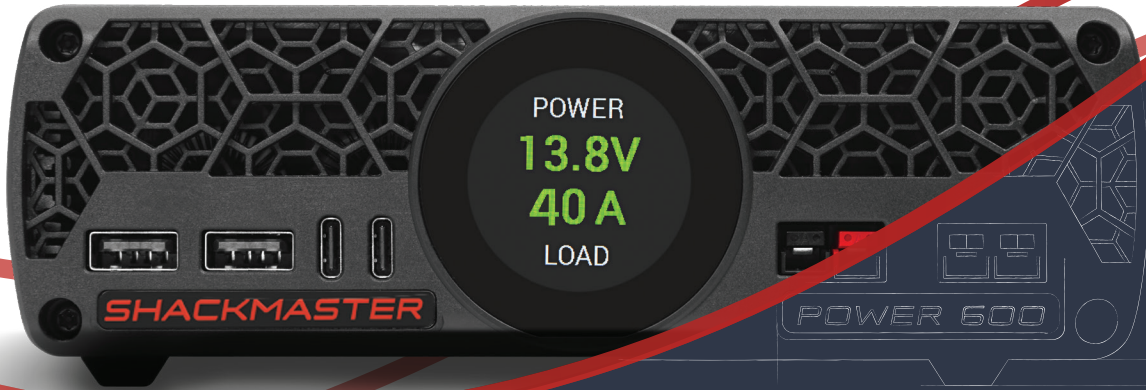

POWER 600 POWER SUPPLY

Instruction Manual



POWERED BY

RigExpert

- ADJUSTABLE OUTPUT VOLTAGE, 11-15V, MAX. 40A
- DEADLY QUIET
- HIGHLY EFFICIENT
- LIGHTWEIGHT AND COMPACT
- OXPEDITIONS COMPATIBLE
- TOLERANT TO GASOLINE GENERATORS
- SAVES WORKSPACE DUE TO FLEXIBLE ORIENTATION
- 4 USB PORTS WITH QUICK CHARGE 2.0

POWER 600 POWER SUPPLY



For latest manuals and software updates, please visit

rigexpert.com

Introduction	4
Product Registration	7
Safety considerations	7
Specifications	8
Structure & Functions	10
Accessories	10
Installation	11
First Power-Up	13
Operation	15
Touch Panel Usage	15
Powering Device Up	16
Display Control	17
Intelligent Protection System	20
Service Functions	22
Precautions	30
Declaration of conformity	32



Congratulations on purchasing our **Shackmaster® Power 600** 40A|13.8V Power Supply. **Rig Expert Ukraine Ltd.** is pleased that you have chosen one of our products, and we will endeavor to provide you with the information and support you need to enjoy your purchase for many years. We urge you to read all of the following materials before you start operating your new power supply.

This wonderful power supply is designed to suit your needs as it:

- **Ensures consistent and reliable power supply** to your devices and maximizes the life of overload-sensitive devices.
- **Protects** your equipment from overcurrent, overvoltage, and overheating.
- **Minimizes** electromagnetic interference and acoustic noise.
- **Ensures ergonomics** of your workspace due to vertical or horizontal installation.
- **Provides power** for demanding tasks and power-intensive setups.
- **Offers a variety of ports** for connecting various gears.
- **Charges** devices, connects peripherals, or powers USB-compatible gadgets.
- **Monitors** voltage, current, and power consumption in real-time.
- **Lets you log and analyze** consumption data.
- **Runs flawlessly in DXpeditions** thanks to its tolerance to gasoline generators, wide operating temperature range and internal power consumption logger.
- **Runs 4 USB ports with Quick Charge 2.0.**
- Lets you **adjust output voltage.**

Shackmaster® Power 600 is the High-Quality DC power supply designed to ensure stable and adjustable 13.8V voltage for the following use for:

13.8V HF and VHF transceivers, amateur radio accessories like VHF, UHV, battery chargers and microwave transverters.

Low Noise HF and VHF preamplifiers, antenna rotator controllers, control and RF antenna relays, etc.

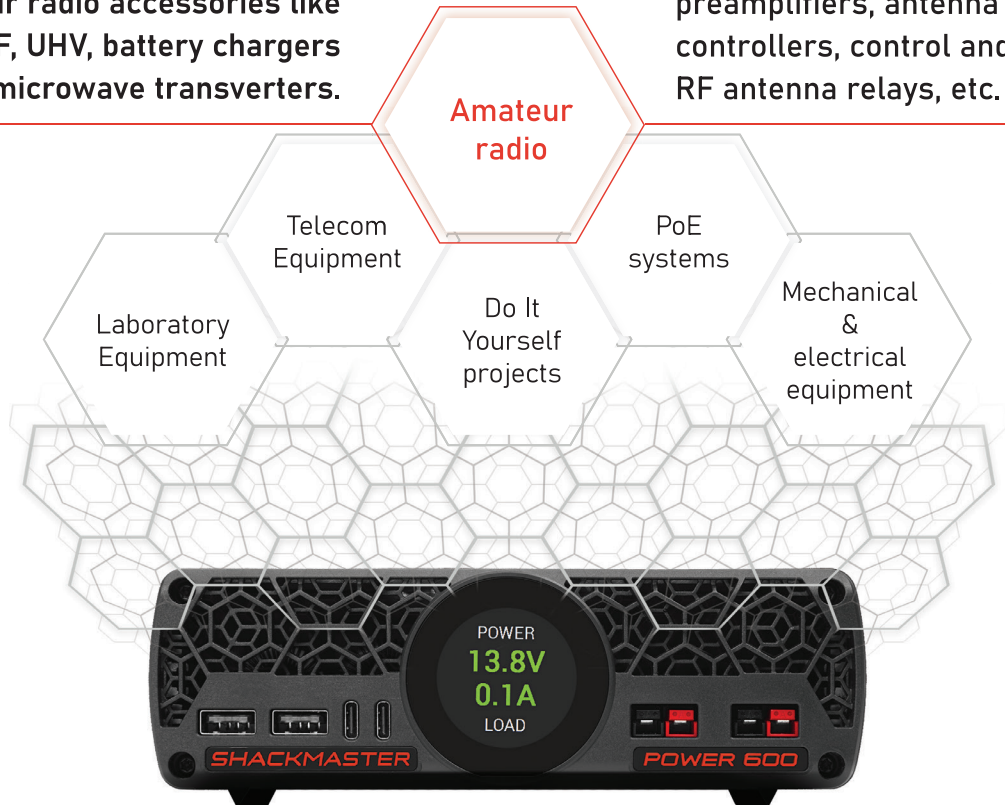

SHACK MASTER

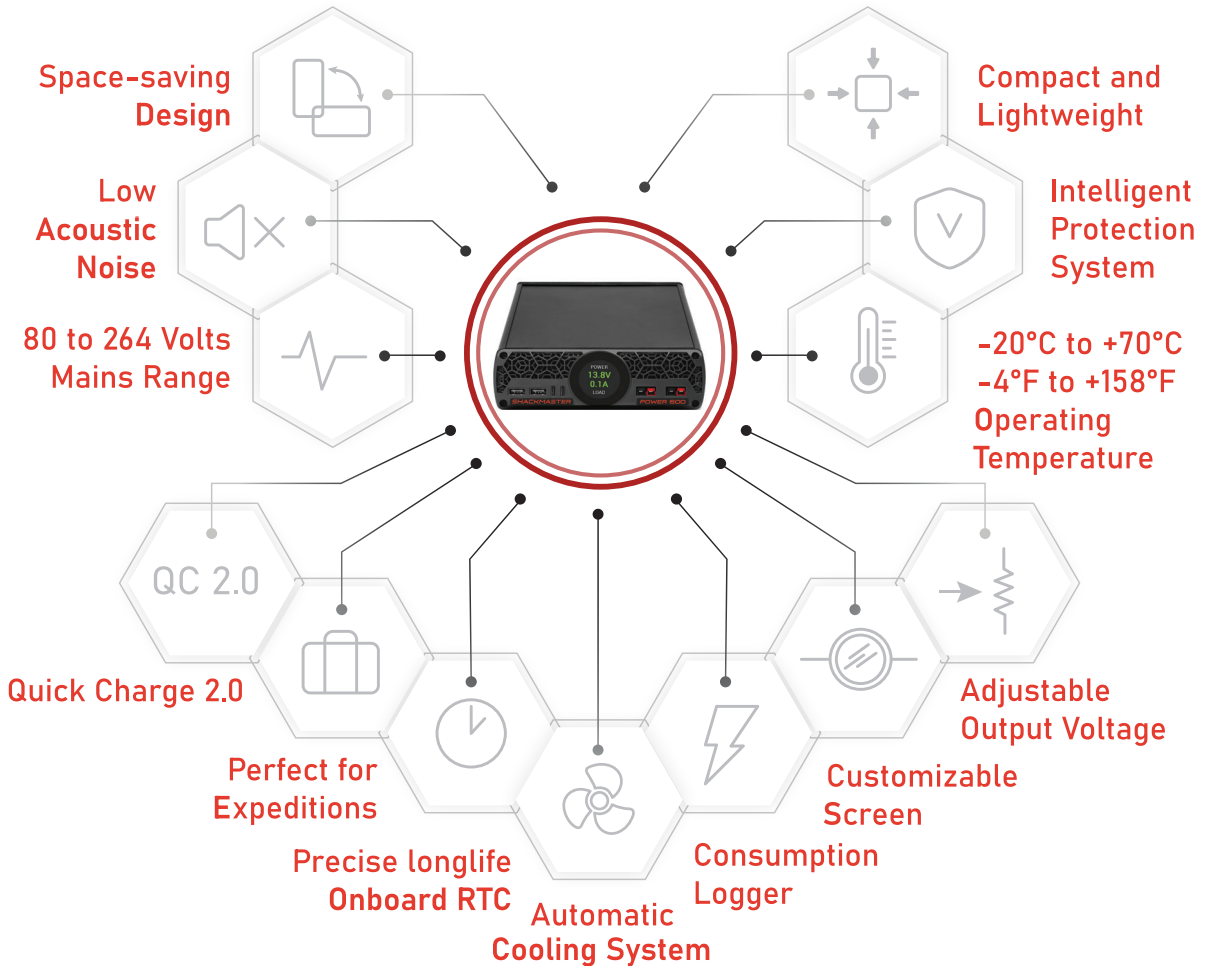

Product Registration

Registration brings benefits.

You will get significant benefits with RigExpert Club:

- Additional 1 year replacement warranty from RigExpertCare
- Product software updates by email
- Special promotions and offers
- Chance to win a gift certificate

To participate in the new support program, you need to use the RigExpert Club card found inside the box:

- Scan QR-code on the Club card with a smartphone/tablet > You can see a Registration form > Fill it down > You will get a notification: «Congratulations! You have joined the RigExpert Club»
Link for registration <https://rigexpert.com/login/>

Safety Considerations

The Shackmaster® Power 600 Power Supply is a Safety Class I unit. The grounding of the device is provided by the power cord, take care to ground your power outlet for safe operation.

The power supply is designed to meet international safety standards and complies with CE safety and electromagnetic compatibility requirements, as well as FCC regulations. This operating manual contains a number of precautions and warnings that **MUST BE FOLLOWED BY THE USER** to ensure the safe operation of the power supply. Use the AC cable delivered with this unit.

Computer power cords with IEC C13 plug are also compatible.

Specifications

Rated power *	600W
Rated current	40A
Output voltage	13.8V (12-15V Software adjustable)
Ripple (maximum)	200mVp-p
Input AC voltage	80V to 264V
Input AC frequency	47Hz to 63Hz
AC current (maximum)	6.4A @ 115VAC 3.2A @ 230VAC
Inrush current (maximum)	40A @ 115VAC; 80A @ 230VAC
USB Charging Ports ***	5V/2.5A, 9V/2.5A, 12V/2.5A
Overvoltage protection	Yes
Overtemperature protection	Yes
Overcurrent protection	Yes
Short circuit protection	Yes
Operating temperature range**	-20°C to +70°C -4°F to 158°F
Storage temperature range	-40°C to +85°C -40°F to 185°F
EMC	EN IEC 61000-6-3:2021; EN IEC 61000-6-1:2019
Dimensions	172mm x 55mm x 185mm 6.8" x 2" x 7.3"
Weight	1.1kg 2 lb 7oz
Acoustic noise	~21 dBa

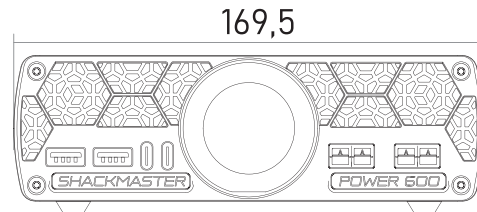
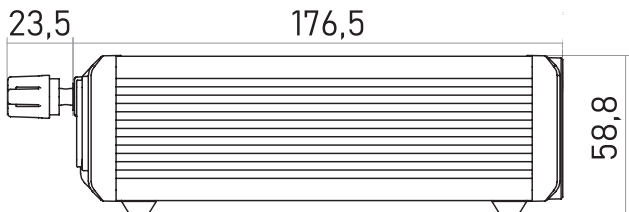
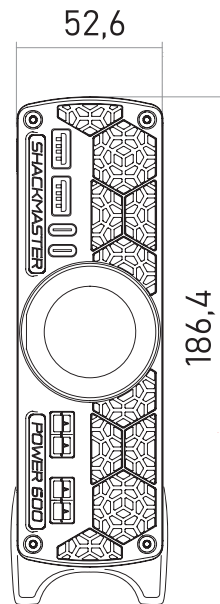

* Output Derating VS Input Voltage

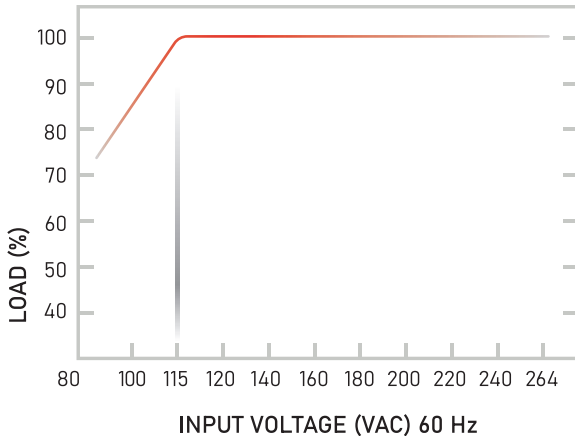

** Derating Curve

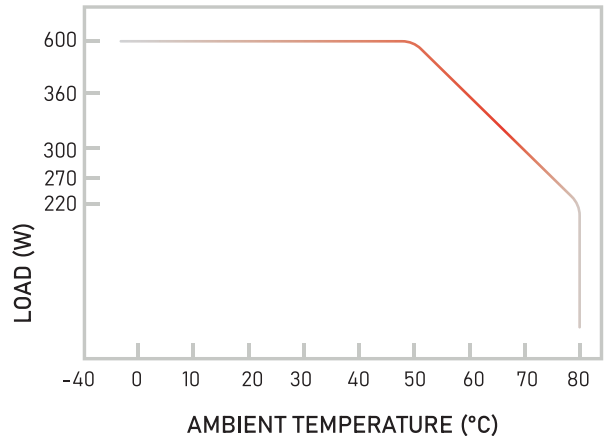

*** USB Charging Ports

- Support DCP 5V 2.5A
- Support BC1.2, Apple, Samsung
- Support Qualcomm QC2.0, QC3.0
- Support MTK PE+1.1 and MTK PE+2.0
- Support Huawei Fast charge: FCP and SCP
- Support Samsung fast charge : AFC
- Support Spreadtrum fast charge : SFCP
- Support USB PD 2.0 : 5V/2.4A, 9V/2.4A, 12V/2.3A
(not supported 15V/2A, 20V/2A, PD3.0)

Structure & Functions

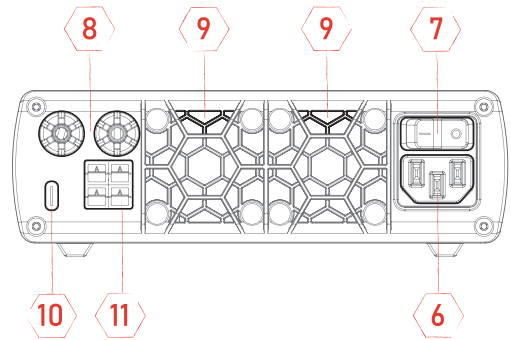
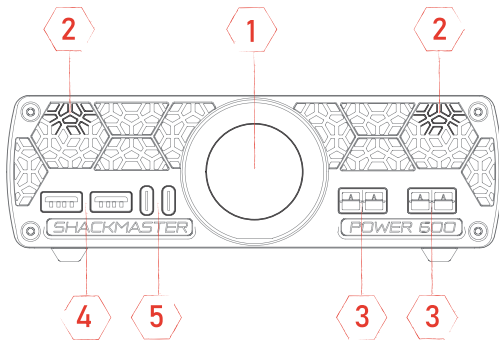

- 1 240x240 Color TFT LCD with Capacitive Touch Panel
- 2 Cooling System Intakes
- 3 45A Anderson Powerpole Connectors
- 4 USB Type-A Charging Ports
- 5 USB Type-C Charging Ports

- 6 Mains Power Entry
- 7 Mains Line Switch
- 8 30A Binding Post
- 9 Fan Outlet (Exhaust)
- 10 Type-C PC Communication
- 11 45A Anderson Powerpole Connectors

Accessories

- Shackmaster® Power 600 Power Supply
- AC power cable
- User manual
- USB cable for computer control
- Four silicon bumpers

THE MANUFACTURER CAN
CHANGE THE CONTENTS
WITHOUT FURTHER NOTICE.

Before plugging the **Shackmaster® Power 600 Power Supply** into an AC outlet, make sure that the mains voltage is within the 80 to 264V AC range.

For user convenience this power supply can be placed horizontally or vertically on the special stands as shown on the picture.

For vertical position the special bumpers used.

In this case the silicon bumpers are not needed.

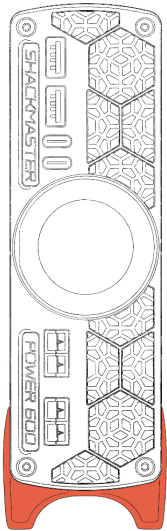

If the unit is placed horizontally use four silicon feet.

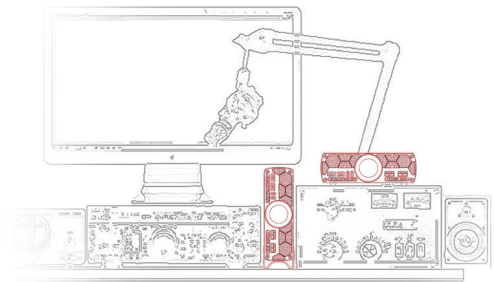
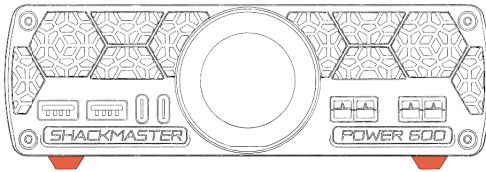

Two USB Type-A and two USB Type-C connectors are at the bottom-left corner of the front panel and can be used for gadgets charging.

The Anderson Powerpole® Connectors are at the bottom-left corner.

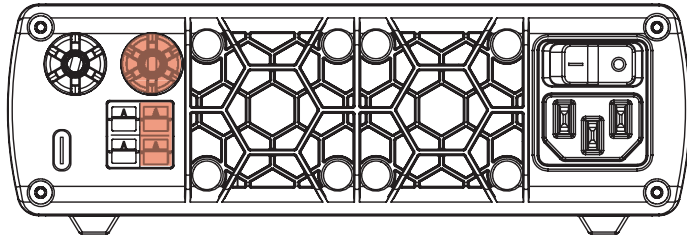

The loads can be connected also to Anderson Powerpole® connectors at the rear panel. There are additional connectors at the rear panel of the power supply:

- one USB Type-C connector for PC connection
- 1x Binding 13.8V post (pair)

Anderson Powerpole® and Binding posts are color coded as:

Red - + (plus 13.8V), **Black** - - (minus 13.8V)

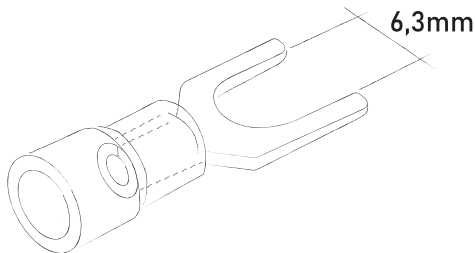

It is recommended to connect the load to the binding posts by Fork spade terminals.

The main power switch is at the right-top corner of the rear panel.

Before you perform the first power-up, make sure your setup complies with the safety requirements outlined below.

WARNING

General safety precautions below must be followed in each phase of the power supply operation. In case of failure to follow these precautions or specific warnings in other parts of the manual is considered as violation of the safety standards related to the design, manufacture and intended use of the instrument. If the user does not follow these precautions, the Manufacturer will be held not responsible for any consequences.

- The Power 600 can only be used indoors or in low condensation areas. The general environmental requirements are stated in the Specifications section.
- To avoid accidental injury, the power cord supplied by the manufacturer only must be used.
- The Power Supply is provided with a three-core power cord that should be connected to a three-core outlet which is properly grounded. Before operation, make sure that the Power 600 is well grounded.
- Use electric wires of appropriate load. All loading wires should be capable of bearing maximum short-circuit of electronic load without overheating.

- To prevent burnout, please pay special attention to positive and negative polarities of electronic load during connection!
- Do not use damaged equipment. Please check the housing before using the equipment. Check whether the device has cracks or lacks plastic. Do not operate the power supply in the environment with explosive gas, steam or dust.
- Do not install alternative parts on the instrument or perform any unauthorized modification.
- We do not assume responsibility for any direct or indirect financial damage or loss of profit that might occur when using the power supply.
- Do not use the equipment on the life support system or other equipment with safety requirements.

CAUTION

Reduce the load if the built-in protection system displays a warning to reduce the power consumption.

Always use dry cloth to clean the Power Supply housing.

Do not clean the inside of the instrument.

Do not block the air vent of the Power Supply.

Touch Panel Usage

The device is equipped a multifunctional color display with a touch panel. The touch panel is used to turn the device on and off, as well as to control display modes. Please use the following gestures:



Tap



Long Press

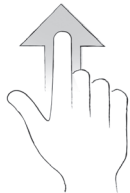

Swipe Up

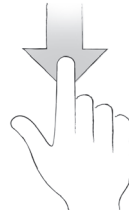

Swipe Down



Swipe Right

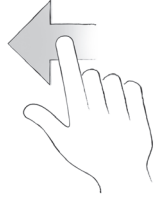

Swipe Left

The panel distinguishes several gestures: tap, long touch and swipe.



Some modes use a sequence of gestures.
For example, swipe and tap go sequentially one after another.



A tap is where you lightly touch a spot on the screen for just an instant. You can use this gesture to activate the screen



A **long press (press-and-hold)** is done when you touch the screen and hold your finger on the same spot. This gesture can be used for quick power off/on.

Tap (short press) the screen can be used to switch the display menu.

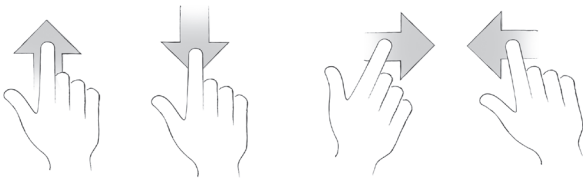

A **swipe** is done when you touch and slide your finger across the screen.

You can swipe quickly or slowly.

The device distinguishes between **swiping up, down, left and right**.

Powering Device Up

Once you have completed all the preparations, you can turn the Power switch ON on the rear panel to position "I". After that, the device will go into Standby Mode turning on the screen for a short time to show the Device Serial Number.

By default, the device is configured to be Switched On / Off by a Swipe gesture or a Long Press gesture.

Later, you can change these and other settings yourself using the ShackPower companion software.

To Turn device ON quickly use a Long-Press gesture.

To Turn device OFF quickly, also use a Long-Press gesture.

Controlling the display

Press the power switch ON at the top-right corner of the rear panel to turn on the power supply. The orange welcome message shows up on the round front panel LCD touchscreen.

The next step is to tap the panel LCD touchscreen for screen activation, the following message will appear: **SWIPE TO SWITCH ON**



The next step of switching on is to swipe the screen right or left. After successfully switching on the Power 600 the measured values screens will be available.

Switching between the parameter screens is done with a short tap.

Total parameters screen shows the cumulative power, the current on all channels and temperature: **TOTAL**



Screen of the 13.8V outputs shows the consumed power and the current: **POWER**



Screen of conditions shows mains voltage, temperature and mains frequency. **SITE**



Screens of USB 1..4 show the voltage, the current and the power for each channel: **USB #**



Display control

To switch the power supply OFF use Swipe right and

touch **SWITCH OFF**

Press the power switch OFF to turn off the power supply.



To enter the **SETTINGS** menu using Swipe right and touch **SETTINGS**

You can select the next options in **SETTINGS** :

- **VTUNE** (adjusting the voltage output)
- **INFO** (Device name, serial number and FW version)
- **DISPLAYS** (selection a screen which will be show)
- **TIME** (manual time set)
- **TEMPER.** (choosing F or °C)
- **EXIT** (exit from SETTINGS)



To list the options, use the Swipe up or down. For enter option submenu use touch or Swipe left on the selected submenu. For closing of SETTINGS select the Exit and touch it.

Submenu **VTUNE**

Set the voltage value touch the whole or decimal part of a number and use "+" or "-". Swipe right for exit of submenu.



Submenu **INFO**

You can see the device name, serial number and FW version.
Swipe left for exit of **VTUNE** submenu.



Submenu **DISPLAYS**

Select which screen to show on the display. Use Swipe up or down and touch (or Swipe left) on the needed screen.



Then choose to show "Yes" or "No" selected screen. Swipe right for exit of submenu.

Submenu **TIME**

Set time using touch for switch between hours and minutes and touch "+" and "-". Swipe right for exit of submenu.



Submenu **TEMPER**

Select temperature units using touch "C" (Celsius) or "F" (Fahrenheit). Swipe right for exit of submenu.



Submenu **EXIT**

Swipe left for exit of **SETTINGS** menu.



The following automatic functions can be controlled by the software:

- automatic power-off if inactivity is longer then determined of inactivity,
- automatic ON/OFF switching at the determined time set:
- automatic switching back ON in case of mains failure.

The RigExpert ShackPower software can be used to adjust and tune the display.

The main task of this system is to keep the user informed at all times to make the device using comfortable and safe.

The intelligent protection system is a state machine that, depending on the parameters of the load, the mains, and the air temperature, provides power consumption control and, in case of adverse conditions, warns the user that power consumption should be limited to avoid damage of the Power Supply.

The power supply delivers maximum rated power if the input voltage is in the range from 115 to 260 Volts and the room temperature is not higher than 40 °C (104 °F). We consider this wide enough range of voltages and temperatures to be ideal operating conditions. In all other cases, the maximum permissible value of power consumption is less than the nominal value and depends on the conditions. Therefore, if the current conditions are not ideal and power consumption is close to the maximum, the protection system will gently notify you about this and ask you to reduce consumption.

For example, with a mains voltage of 80 Volts and at +70 °C air temperature in the room of +70 °C, the maximum output power will be limited to 300 W, and the user will be warned about it.

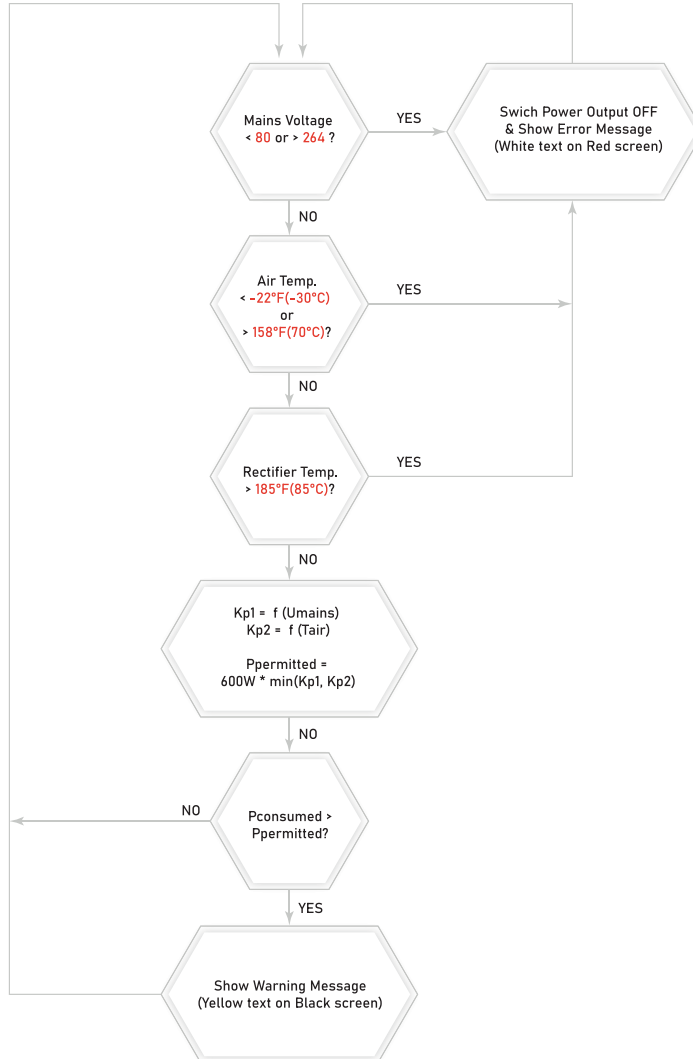

The power supply has an interface with a computer, that provides you with additional capabilities of device control and its condition monitoring, namely:

- The special companion PC software to log consumption and auxiliary data both for USB and Anderson Powerpole[®] Connectors during the operation of the power supply.
- USB interface to log consumption data and update firmware.

The following automatic functions can be controlled by the software:

- automatic power-off if inactivity is longer then determined of inactivity;
- automatic ON/OFF switching at the determined time set;
- automatic switching back ON in case of mains failure.

The RigExpert ShackPower software can be used to adjust and tune the display.

Installing ShackPower software

The RigExpert[®] ShackPower software enables you to control the Power 600 power supply remotely via USB interface. This instrument enables you to record all aspects of the operation of the Power 600 supply over a long period of time and subsequently analyze the accumulated data subsequently.

The setup program installs ShackPower software on PC's running Windows, MacOS and Ubuntu operation systems.

To install the software, download the latest software installer from the Shackmaster Power 600 product page:

<https://rigexpert.com/products/powersupply/shackmaster-power-600/>

Connecting the Power 600 to the PC

To connect **Shackmaster® Power 600** to your PC please use the cable supplied with the device.

You can also use any high-speed USB cable with a USB A connector on one side and USB Type-C on the other side.

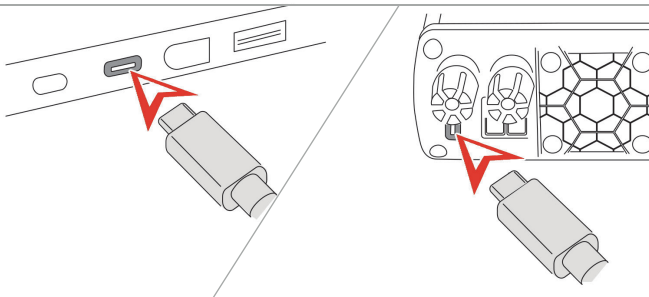
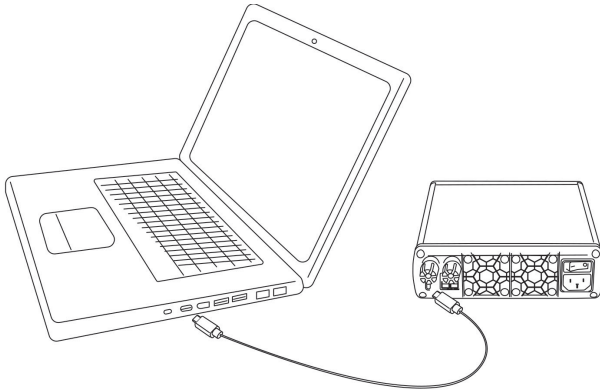

ShackPower screen

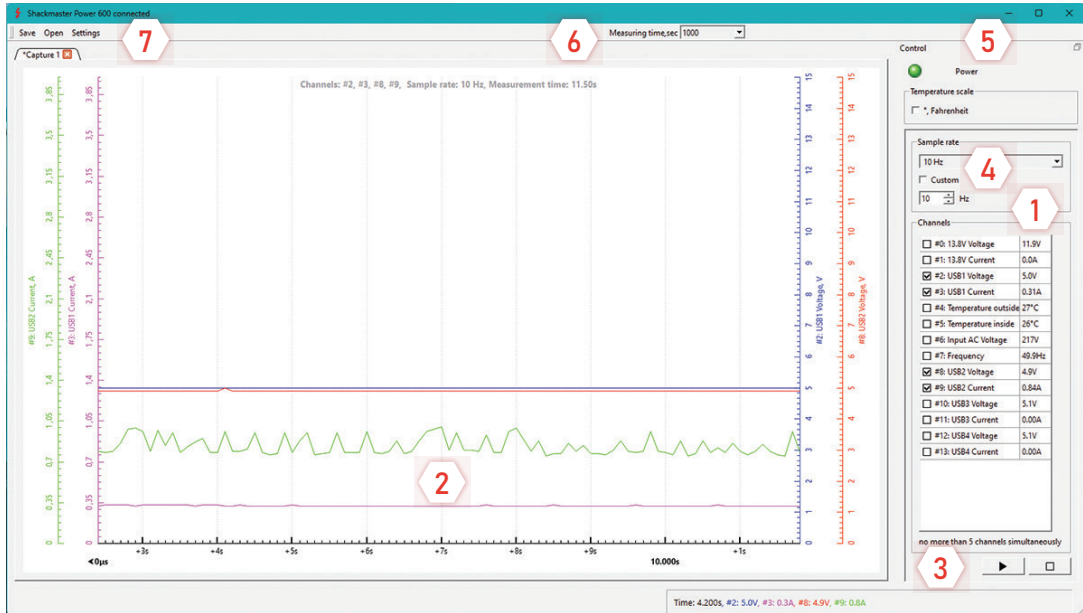

- 1 Recordable Parameters measured by the device
- 2 Sampled Data Representation
- 3 Start / Stop Logging controls
- 4 Sample Rate Controls
- 5 Device Configuration Tools
- 6 Logging Interval
- 7 Display Interval (Display window width in seconds)

Logging Process

When ShackPower software communicates with the Power 600 power supply the software is in measurement mode. The measurement mode (logging) is the operating mode which displays instantaneous sampling of the measured value digitized and shown in the form of a graph on the screen and saves data to a log file. Several parameters can be recorded and displayed simultaneously using the controls. You can also set length of the period when these parameters will be recorded and the sample rate. Please remember that after the parameters have been changed, you must restart the measurements by clicking Stop and Play buttons sequentially. In this case, the previous measurement results will be saved in a separate tab in the «Sampled Data Representation» window.

Better to see once

Let's try to collect the parameters of the power supply unit together. As an example, we record data about the amount of current consumed by your mobile phone when it is charged

And, most importantly, let's see what the nature of this consumption is. First of all, we will select the sample rate- the frequency with which we will measure the current consumption value. Let it be 100 Hz. Use the dropdown list to select the desired value.

The next step is to choose the specific parameter to be monitored.

As we agreed at the beginning, we take a current consumption at 5V line.

Channel	Parameter	Value
<input type="checkbox"/>	#0: 13.8V Voltage	11.2V
<input type="checkbox"/>	#1: 13.8V Current	0.0A
<input checked="" type="checkbox"/>	#2: USB1 Voltage	5.0V
<input checked="" type="checkbox"/>	#3: USB1 Current	0.40A
<input type="checkbox"/>	#4: Temperature outside	25°C
<input type="checkbox"/>	#5: Temperature inside	24°C
<input type="checkbox"/>	#6: Input AC Voltage	213V
<input type="checkbox"/>	#7: Frequency	50.0Hz
<input checked="" type="checkbox"/>	#8: USB2 Voltage	4.8V
<input checked="" type="checkbox"/>	#9: USB2 Current	0.06A
<input type="checkbox"/>	#10: USB3 Voltage	5.1V
<input type="checkbox"/>	#11: USB3 Current	0.00A
<input type="checkbox"/>	#12: USB4 Voltage	5.1V
<input type="checkbox"/>	#13: USB4 Current	0.00A

no more than 5 channels simultaneously



We are almost done. All you have to do is to click the Play button.

Connect your phone to one of the USB outputs on the front panel. Immediately afterwards, you will see that the phone is consuming current. And the consumption is intermittent.

It's time to examine the operation of your transceiver. To do this, just stop logging, select a measurement in the Channels window, for example, the value of current consumption along a 12V line, and start logging again.

To stop logging press the **Stop** button.

To see the accumulated data that is outside the screen, use the mouse to drag the time arrow in the desired direction.

Please remember that although the internal measurement circuits of the power supply have good accuracy, this device is not a laboratory meter. The main task of the logger is to show you the nature of the load that you connect to the power supply, as well as to identify short-term anomalies in operation of that load which cannot be noticed by the unaided eye. The ability to place control panel at the user's request.

By the way, if you need to measure currents less than 100 μ A, use our other product - REAMP Power Measurement tool and logger

<https://rigexpert.com/products/reamp-logger/reamp/>

Customizing device settings

The ShackPower software allows you to configure the device to make it convenient for you to work with it. To go to customization mode, click the Device Settings button in toolbar.

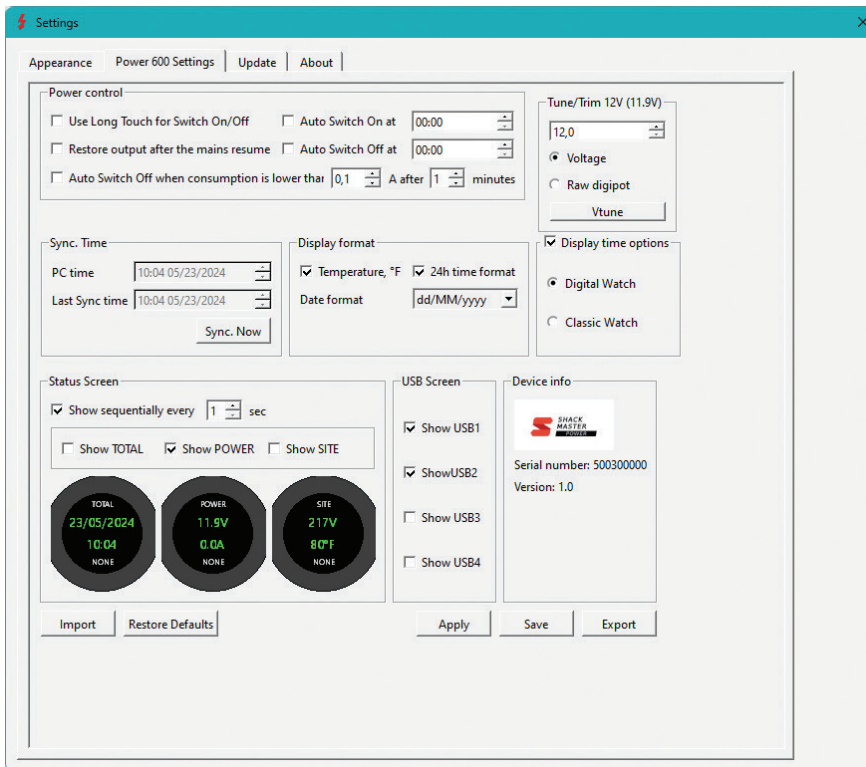

In the settings window that opens you can set the following parameters:

- Whether to use a special gesture to quickly turn the device on or off, what to do after the mains failure, do Power 600 need to turn off if it is not used for a long time. As the power supply has a built-in ultra-precise real-time clock, you can set the power supply to turn on and off depending on the time of day
- When changing the output voltage level, press the Vtune button, and then the Save button to save this setting
- Whether it is necessary to show the clock on the device display when it is turned off
- Which information screens should be shown and what information should be displayed on each of them. You can enable sequential display of all configured screens to see everything that is happening in the equipment connected to the power supply



The new settings will take effect if you click the **Apply** button and then click the **Save** button. If you push only the Apply button, the new changes settings will take effect, but they will be lost when the device is turned off. If you push only the Save button, the new changes settings will not take effect, the previous settings will be saved in this case. You can create an archive of device settings on a PC using the Export button to save to a file, Import to load settings from a file. To return the device to factory settings, use the Restore Defaults button.

Remote control

To control the power supply from third-party software or via the Internet, you can use a special script written in Python.

First of all, download `hid_switch_power_on.py` and `hid_switch_power_off.py` files from Power 600 product page.

<https://rigexpert.com/files/libraries/PowerSupply/>

To switch Power 600 on just run `hid_switch_power_on.py` script. To turn off the power supply, use the `hid_switch_power_off.py` script.

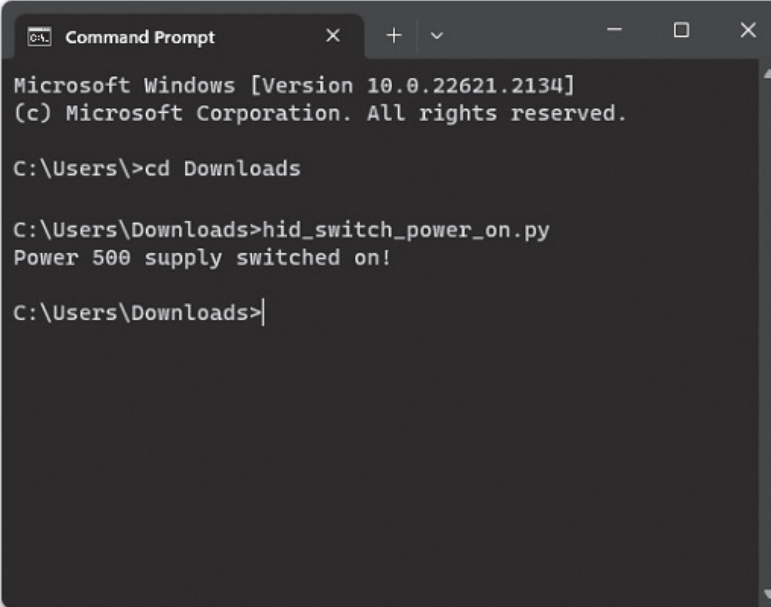

```
Command Prompt
Microsoft Windows [Version 10.0.22621.2134]
(c) Microsoft Corporation. All rights reserved.

C:\Users\>cd Downloads

C:\Users\Downloads>hid_switch_power_on.py
Power 500 supply switched on!

C:\Users\Downloads>
```

Precautions

Danger



NEVER ALLOW ANYONE, ESPECIALLY CHILDREN, to push anything into the case holes or to otherwise touch the power supply or its connecting cables. There is grave danger of fatal electrical shock.



Do not plug/unplug the power supply with wet hands. It may easily cause electric shock.



Do not use the power supply where there may be flammable gas. This may cause fire and explosion.

Caution



DO NOT OBSTRUCT AIR INTAKE or EXHAUST areas of the power supply. Keep a minimum distance of 20cm (8 inches) clear of the rear panel air exhaust opening.



Note that your grounding system may have to handle a current of more than 15 Amperes. This requires an adequately sized and well-maintained conductor of at least 4 mm² (AWG 11 or AWG 13). If this is not the case at your operating location, you should make the necessary changes using a licensed electrician.

Caution



Do not undertake or perform any repair or adjustment of your power supply yourself, including any attempt to change hardware.

Doing so creates a potentially fatal shock hazard and may damage the power supply or equipment connected to it. Rig Expert Ukraine Ltd. is not responsible for any such personal injury or equipment damage whether caused by accident or as a result of good faith efforts of repair or adjustment.



Make sure that devices that are to be connected to the power supply meet its specifications, otherwise it may cause damage to the product.



Always hold the plug when plugging/unplugging the power supply.

Never unplug the power supply by pulling the cable as it may cause fire, shock and damage to the power supply.



Unplug the power supply immediately if anything unusual happens, such as smoke and or strange odors coming from it.

Contact the authorized service centers immediately for service.



Do not use the power supply for devices that require high current input at the start, such as motorized equipment and tools.

Do not charge the car battery. This may trigger the overcurrent protection circuit or even may cause damage to the power supply.

EU DECLARATION OF CONFORMITY

Manufacturer's Name: Rig Expert Ukraine Ltd.

Manufacturer's Address: # 918, Solomyanska Square, 2, 03035, Kyiv, Ukraine.

Declares that the product specified below:

Product Name: Power Supply RigExpert

Model Number: Shackmaster Power 600

Conforms to the requirement of:

EMC Directive: 2014/30/EU

Low Voltage Directive: 2014/35/EU

Electrical Compatibility (EMC):

EN IEC 61000-6-3:2021

EN IEC 61000-6-1:2019

Electrical Safety:

EN 62368-1:2014+A11:2017

RoHS:

EN IEC 63000:2020

Director _____ Ashot Andreev,
29 May 2024

For private households:

Information on Disposal for Users of WEEE

This symbol on the product(s) and / or accompanying documents means that used electrical and electronic equipment (WEEE) should not be mixed with general household waste.

For proper treatment, recovery and recycling, please take this product(s) to designated collection points where it will be accepted free of charge.

Alternatively, in some countries, you may be able to return your products to your local retailer upon purchase of an equivalent new product.

Disposing of this product correctly will help save valuable resources and prevent any potential negative effects on human health and the environment, which could otherwise arise from inappropriate waste handling. Please contact your local authority for further details of your nearest designated collection point. Penalties may be applicable for incorrect disposal of this waste, in accordance with your national legislation.

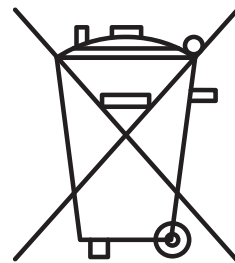

For professional users in the European Union

If you wish to discard electrical and electronic equipment (EEE), please contact your dealer or supplier for further information.

For disposal in countries outside of the European Union

This symbol is only valid in the European Union (EU). If you wish to discard this product, please contact your local authorities or dealer and ask for the correct method of disposal.

www.rigexpert.com

Copyright© 2020-2024 Rig Expert Ukraine Ltd.

«RigExpert» is a registered trademark of Rig Expert Ukraine Ltd.



Doc. date: 16-April-2024