



RT-650 VHF Marine Radio

With Wireless Accessory Microphone

With Integrated AIS Receiver

Owner's Manual



I

OPERATOR WARNING

Navicom requires the radio operator to meet the requirements for Radio Frequency Exposure. Unauthorized changes or modifications to this equipment may void compliance with ETSI Rule. Any changes or modifications must be approved in writing by Navicom.

This equipment has been tested and licensed to comply with the limits for Class D Digital Marine Devices. These limits are designed to provide reasonable protection against harmful interference in a residential installation. This equipment can generate or radiate radio frequency energy and, if not installed and used in accordance with the instructions, may cause harmful interference to radio communications and human body. Never transmit before you make sure the antenna is properly installed.

This device is only an aid to navigation. Its performance can be affected by many factors including equipment failure or defects, environmental condition and improper handling or use. It is the user's responsibility to exercise common prudence and navigational judgment, and this device should not be relied upon as a substitute for such prudence and judgment. Your Navicom VHF radio generates and radiates radio frequency (RF) electromagnetic energy (EME). This equipment must be installed and operated in accordance with the instructions contained in this handbook. Failure to do so can result in personal injury and/or product malfunction.

TABLE OF CONTENTS

1. EQUIPMENT DESCRIPTION	7
1.1 INTRODUCTION	7
1.2 ETSI INFORMATION	7
2. CONTROLS AND LCD DISPLAY	8
2.1 BASE STATION PANEL	8
2.2 BASE STATION PANEL (REAR)	10
2.3 WIRED HANDSET	10
2.4 LCD DISPLAY OF BASE STATION	11
3. INSTALLATION	13
3.1 SUPPLIED ACCESSORIES	13
3.2 LOCATION	13
3.3 CONNECTIONS	14
3.4 MOUNTING THE RADIO	15
3.5 ANTENNA MOUNTING/THE EME EXPOSURE	17
3.6 MOUNTING THE HANDSET	17
4. BASIC OPERATION	18
4.1 TRANSMISSION AND RECEPTION	18
4.2 BAND SWITCH	18
4.2.1 USA AND INT MODE	18
4.2.2 MEMO (FAV) MODE	19
4.3 SAVE MEMORY (FAV) CHANNELS	19
4.4 TRANSMIT TIME-OUT-TIMER (TOT)	19
4.5 SCAN	19
4.6 WATCH	20
4.6.1 DUAL WATCH	20
4.6.2 TRI WATCH	20
4.7 POSITION INDICATION	20
4.8 INTERCOM	20
5. DIGITAL SELECTIVE CALLING	21
5.1 GENERAL	21
5.1.1 MARITIME MOBILE SERVICE IDENTITY	21
5.1.2 HOW CAN I OBTAIN A MMSI ASSIGNMENT	21
5.2. DSC CALL TYPES	22
5.2.1 SEND A DISTRESS CALL	23
5.2.2 SEND AN ALL SHIPS CALL	23
5.2.3 SEND A GROUP CALL	24
5.2.4 MAKE A ROUTING CALL (INDIVIDUAL)	25
5.2.4.1 MANUALLY SENDING AN INDIVIDUAL CALL	25
5.2.4.2 SENDING AN INDIVIDUAL CALL	26
5.2.4.3 ACK OF AN INDIVIDUAL INCOMING CALL	26
5.2.5 LAST CALL	26
5.2.6 SEND AN IND. CALL USING THE CALL LOG	26
5.2.7 SEND AN IND. CALL USING THE DISTRESS LOG	27
5.2.8 POS REQUEST AND POP REPLY	27

5.2.8.1 POS REQUEST	27
5.2.8.2 POS REPLY	28
5.3 RECEIVING DSC CALL	28
5.3.1 DISTRSS CALL	28
5.3.2 DISTRSS ACK FROM A COAST STATION	29
5.3.3 DISTRESS RELAY CALL	29
5.3.4 ALL SHIPS CALL	29
5.3.5 GROUP CALL	30
5.3.6 INDIVIDUAL CALL	30
5.3.7 "POSITION RELAY" CALL	30
5.3.8 GEOGRAPHIC AREA CALL	30
6. SET UP MENU	31
6.1 MENU FUNCTION DESCRIPTION	31
6.2 SET-UP MENU NAVIGATION	32
6.3 BUDDY LIST	32
6.3.1 ADDING AN ENTRY	32
6.3.2 EDIT EXISTING ENTRY	32
6.3.3 DELETE AN ENTRY	33
6.4 BACKLIGHT ADJUSTMENT	33
6.5 CONTRAST ADJUSTMENT	33
6.6 LOCAL/DISTANT	33
6.7 GPS/TIME	34
6.7.1 MANUAL ENTRY GPS DATE	34
6.7.2 SETTING	34
6.7.2.1 POSITION DISPLAY ON/OFF	35
6.7.2.2 TIME DISPLAY ON/OFF	35
6.7.2.3 LOCAL TIME (TIME OFFSET)	35
6.7.2.4 TIME FORMAT OPTIONS (TIME FORMAT)	35
6.7.2.5 COURSE/SPEED DISPLAY OPTIONS (COG/SOG)	36
6.7.2.6 GPS ALERT	36
6.8 RADIO SETUP	36
6.8.1 LANGUAGE SELECTION	36
6.8.2 CHANNEL NAME	36
6.8.2.1 CHANNEL NAME DISPLAY	36
6.8.2.2 CHANNEL NAME EDITING	37
6.8.3 RING VOLUME ADJUSTMENT	37
6.8.4 KEY VOLUME ADJUSTMENT	37
6.8.5 INT SPEAKER ON/OFF	37
6.9 DSC SETUP	38
6.9.1 ENTER YOUR USER MMSI (USER MMSID)	38
6.9.2 MAINTAIN GROUPS	39
6.9.2.1 ENTER YOUR GROUPS	39
6.9.2.2 EDIT USER GROUPS	39
6.9.2.3 DELETE A GROUP	39
6.9.3 ATIS MMSI	40
6.9.4 ATIS ENABLE	40

6.9.5 DSC ENABLE	40
6.9.6 POS REPLY	41
6.10 AIS SETUP	41
6.11 HS SETTING.....	41
6.12 RESET	41
7.0 AUTOMATIC IDENTIFICATION SYSTEM (AIS) RECEIVER	42
7.1 WHAT IS AIS	42
7.2 CLASSES OF AIS	42
7.3 STATIC AND DYNAMIC INFORMATION	43
7.4 AIS INFORMATION AND DISPLAY	44
7.4.1 AIS DATA OUTPUT	44
7.4.2 AIS DATA DISPLAY	45
7.4.2.1 AIS DATA DISPLAY FORMAT	46
7.4.2.2 AIS DATA DISPLAY MODE	46
8.0 RT-650-M WIRELESS MICROPHONE	48
8.1 LOOK AT THE MICROPHONE	48
8.2 LOOK AT THE DISPLAY OF HANDSET	50
8.3 SETTING UP MICROPHONE	51
8.3.1 INSTALLING THE BATTERY PACK	51
8.3.2 CHARGING THE BATTERY.....	51
8.3.3 INSTALLING THE BELT-CLIP.....	52
8.3.4 MOUNTING THE CRADLE CHARGER	52
8.4 BASIC OPERATION	52
8.4.1 LINK THE WIRELESS MICROPHONE TO THE RADIO	52
8.4.2 TRANSMISSION AND RECEPTION	53
8.4.3 BAND SWITCH	54
8.4.3.1 USA AND INT MODE	54
8.4.3.2 SAVE MEMORY (FAV) CHANNELS	54
8.4.4 SCAN	55
8.4.5 WATCH	55
8.4.5.1 DUAL WATCH	55
8.4.5.2 TRI WATCH	55
8.4.6 POSITION INDICATION	55
8.4.7 INTERCOM	55
8.5 SETTING MENU	56
8.6 DSC CALL MENU AND SENDING AND RECEIVING DSC CALLS	57
9.0 MAINTENANCE	57
10.0 SPECIFICATION	59
11.0 CHANNEL LIST	60

1 EQUIPMENT DESCRIPTION

1.1 INTRODUCTION

Congratulations on your purchase of **Navicom** marine band radio. RT-650 is a VHF DSC Base Station Radio with output power of 25/1 watt. It should be powered by a 13.8VDC power supply.

The radio can support DSC (Digital Selective Calling) operation with specially designed DSC unit. When being connected with GPS, it will display the position (longitude and latitude) of the vessel. Compact fist microphone makes for convenient operation of the equipment

The radio have built-in Automatic Identification System (AIS) receiver, to fulfill a need for vessels to know the position, details and navigational intentions of other vessels within VHF range for improved safety and collision avoidance.

The radio is equipped with the new generation 2.4GHz Remote-control wireless Handset microphone (RT-650-M), Convenient operation on board free from wire limit

Other features of the radio include:

- Access to all available International channels (currently allocated).
- Allows memory all channels for quick recall and memory scan.
- Provides as many as 20 user programmable names with MMSI, and 20 individual calls for DSC communications.
- Rotary volume control with power on/off, rotary channel selector and rotary squelch adjustable knob give you more convenient operation of the radio.
- Outstanding performance of waterproof complying with Japanese Industry Standard level 7.
- 25 watts high output power allows you make contact with others in a long distance of marine communication; and 1 watt low power for short distance.
- Separate **16** button, for quick selection of the emergency call on CH16.
- Adjustable brightness of backlit for good visibility of the large LCD in various circumstance.
- External interface easy to connect to GPS and external speaker.
- Mounting gimbals for firm and reliable location of your base station in difference condition.

1.2 ETSI INFORMATION

ETSI (European Telecommunications Standard Institute) has stipulated the specific requirements (**EN 301 025-1/2/3**) on marine radio with **class D DSC** feature, For use on non-SOLAS vessels.

2 CONTROLS AND LCD DISPLAY

2.1 BASE STATION (PANEL)

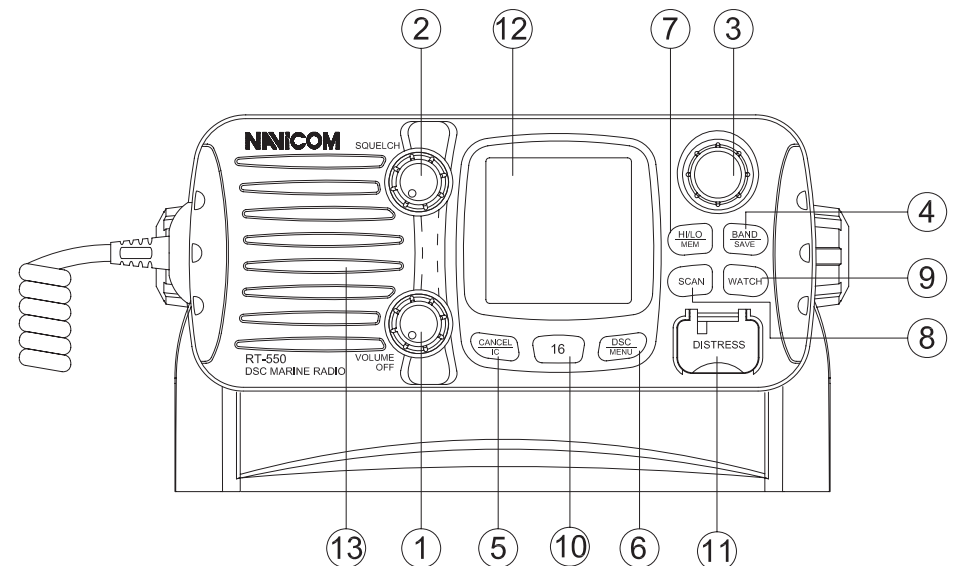

- ① **VOLUME and POWER** 0-270°rotary control Knob. Turn clockwise to power on. Continue to turn until a comfortable audio level
- ② **SQL** Use this knob to set the squelch threshold, which cuts off the receiver when the signal is too weak for reception of anything but noise.
- ③ **CH/ENTER** Rotary encoder (no stop) with momentary push
Rotate this knob to change the current number and change values in menu mode or during programming. Press the knob to enter values
- ④ **BAND/SAVE** Select band (USA. Or INT), Press and hold down to set memory channels
- ⑤ **CANCEL/IC** The button to Cancel last selection or change without saving. It allows step back one level on menu mode. It cancels DSC Distress calls & auto-retransmission of DISTRESS calls. Hold the button to select Intercom mode

- ⑥ **DSC / Menu** Use this knob to enter DSC Call Menu or Setup Menu
Press to enter DSC Menu, and Hold down to enter the Radio Setup Menu

- ⑦ **HI/LO / MEMO** Press button to toggle between 25 watt and 1 watt output. “**H**” or “**L**” icon appears on LCD display to indicate setting
Hold the button to select memory channels mode.

- ⑧ **SCAN** Start and stop normal or priority scan and memory channels or priority channels scan.

- ⑨ **WATCH** Start or Stop dual watch or tri-watch,

- ⑩ **16** Press button to access channel 16 quickly
Press button to quit all other modes and to into the priority channel

- 11 DISTRESS** This button is used to send a signal of distress in case of emergency. See DSC Operation for details of sending the call. This button is cover by a spring cover.
NOTE: The Distress Function or any other transmitted DSC function does not work unless a user's MMSI has been entered.

- 12 LCD** Large LCD (39mmx39mm) with viewable area of graph dot matrix makes it easy to be read.

- 13 Built-in Speaker** Guarantee a clear ring and voice communication

2.2 BASE STATION (REAR)

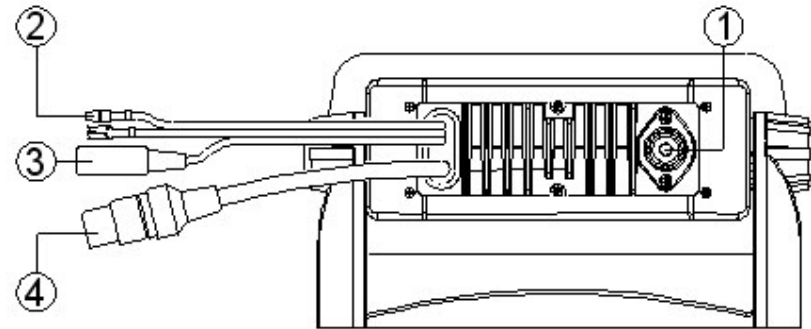

- ① **Antenna Socket** Connect a suitable antenna to your marine VHF radio to get a satisfying communication.

- ② **Power Source** Connect the radio to a 13.8 VDC power source.

- ③ **External Speaker Jack** If need be, you can also use this cable to connect an external speaker.

- ④ **External Connector** Connect the radio to a GPS receiver, and output AIS data to PC or plotter

2.3 Wired HANDSET

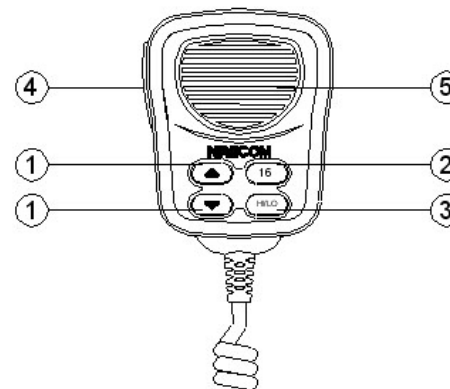

- ① **Channel Up/Down** Press and release to change channel.
- ② **16** Press and release **16** button to select channel 16 first; Press **16** button to quit all other modes and to into the priority channel.
- ③ **Hi/Low** Press and release **HI/LO** button to toggle between 25 watt power output and 1 watt output. The "Hi" or "Lo" icon appears on LCD display to indicate the setting.
- ④ **PTT** Push to enable VHF communication through the 25/1-Watt transmitter.
- ⑤ **Internal Microphone** Well receive your voice information and ensure a reliable communication.

2.4 LCD Display of Base Station

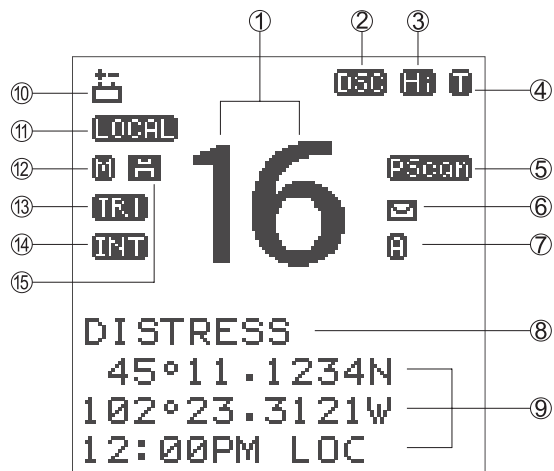

- ① **CHANNEL NUMBER READOUT**
Indicates the selected operating channel number, "A" appears when a simplex channel is selected. "b" appears when a receive only channel for a Canadian channel group is selected. In set mode, indicated the selected condition. "IC" appears during intercom mode
- ② **DSC INDICATOR**
"DSC" appears if DSC function Enable.
- ③ **Hi/Low POWER INDICATOR**
Hi appears while power set to 25W, Lo appears while power set to LO.

- ④ **BUSY/TRANSMIT INDICATOR**
Appears when receiving a signal or when the squelch opens. Appears while transmitting.
- ⑤ **SCAN INDICATOR**
"SCAN" appears during normal scan.
"P SCAN" appears during priority scan.
- ⑥ **MESSAGE UNREAD INDICATOR**
The Envelop icon appears if there is received DSC call you had not read yet.
- ⑦ **DUPLEX INDICATOR**
Appears when a duplex channel is selected.
- ⑧ **CHANNEL NAME INDICATOR**
Channel comment appears (and scrolls) if programmed. In set mode, indicates or scrolls the selected set mode item.
- ⑨ **LL AND TIME INFORMATION**
Latitude and Longitude of the vessel, and the local time.
- ⑩ **LOW BATTERY INDICATOR**
Appears when Battery voltage is low.
- ⑪ **ATTENUATOR INDICATOR**
Appears "Local" when the RF attenuator is in use.
- ⑫ **MEMORY MODE INDICATOR**
The M icon appears if you select the Memory mode.
- ⑬ **DUAL/TRI WATCH INDICATOR**
"DUAL" appears during dual-watch; "TRI" during tri-watch.
- ⑭ **CHANNEL GROUP INDICATOR**
Indicates Whether an international (INT), or U.S.A (USA) channel is selected.
- ⑮ **FAV CHANNEL INDICATOR**
The Disk icon appears while the specified channel had been stored as FAVOUR channel.

3 INSTALLATION

3.1 SUPPLIED ACCESSORIES

Manufacturer supplies you the following accessories as soon as you purchase this RT-650 marine radio:

- 1) Mounting Gimbal (1 pc)
- 2) Power Supply Cable and External Speaker Connection Cable (1 set)
- 3) Mounting Knob (2 pcs)
- 4) Wall Hanger (1 pc)
- 5) External Connection Cable (1 set)
- 6) Self-tapping Screw for Fixing Mounting Gimbal (4 pcs)
- 7) Flat Screw for Fixing Mounting Gimbal (4 pcs)
- 8) Plain Washer (4 pcs)
- 9) Spring Washer (4 pcs)
- 10) Nut (4 pcs)
- 11) Self-tapping Screw for Fixing Wall Hanger (2 pcs)
- 12) Flat Screw for Fixing Wall Hanger (2 pcs)
- 13) Plain Washer (2 pcs)
- 14) Spring Washer (2 pcs)
- 15) Nut (2 pcs)

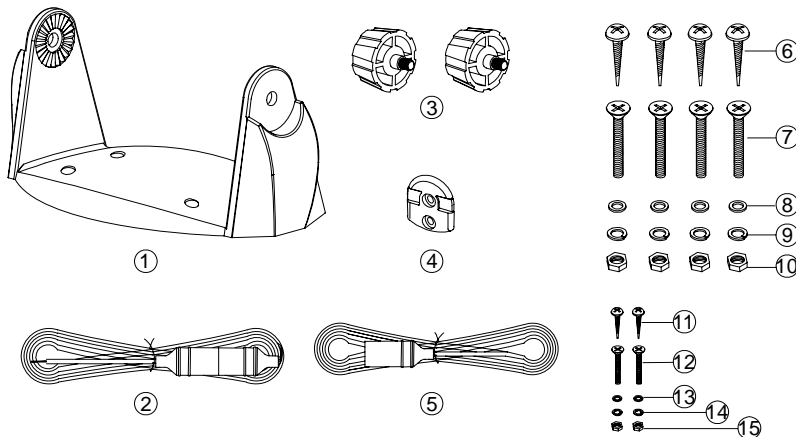

3.2 LOCATION

To more conveniently and efficiently use your marine radio, find a mounting location that:

- Is far enough from any devices like devices to avoid any interference caused by the speaker magnet in your radio during their operation;
- Provides accessibility to the front panel controls;

- Allows connection to a power supply and an antenna;
- Has free space nearby for installation of a handset hanger;
- Where the antenna can be mounted at least 3 feet from radio.

3.3 CONNECTIONS

POWER SUPPLY

You radio should be powered by a 13.8VDC power supply. Red cable is for positive pole and the thicker black one is for negative pole.

EXTERNAL SPEAKER

If needed, you can connect your radio to an external speaker with the supplied connection cable. White cable is for positive pole and the thinner black one is for negative pole.

GPS EQUIPMENT and Plotter;

When yours marine radio RT-650 is connected to GPS equipment, it can obtain the information of both its current location (longitude and latitude) and the local GMT.

Your marine radio also can output the AIS data to external plotter connected.

CABLE details:

- | | | |
|---------------|---|---------|
| NMEA IN (+), | from GPS navigation receiver, pin5. | Yellow. |
| NMEA IN (-), | from GPS navigation receiver, pin4. | Green. |
| NMEA OUT(+), | Pin2. | Orange |
| NMEA OUT(-), | Pin6. | Black |
| NMEA OUT(+), | Pin7 Blue 38.4K Baud for AIS data output | Blue |
| NMEA OUT (-), | Pin8 Grey 38.4 K baud for AIS data output | Grey |

NEMA 0183 Version (1.5 to 3.0) input Sentences:
The sentences GLL, GGA, RMS, GNS shall be recognized.

Note: Never short wires. This may lead to malfunctions.

Connect round plug to radio and wires yellow and green to GPS navigation receiver. blue and grey wires to Multi-function Display or Plotter for AIS application.

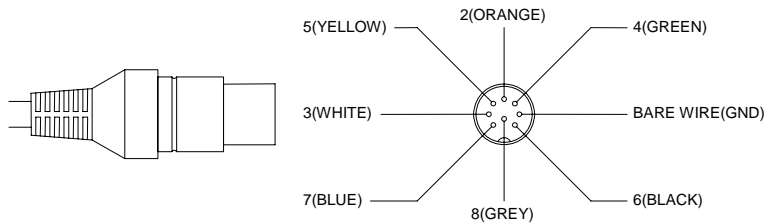

ANTENNA

A very important part for the performance of any communication system is a suitable antenna. Consult your dealer about antennas and ask them to help to mount your radio.

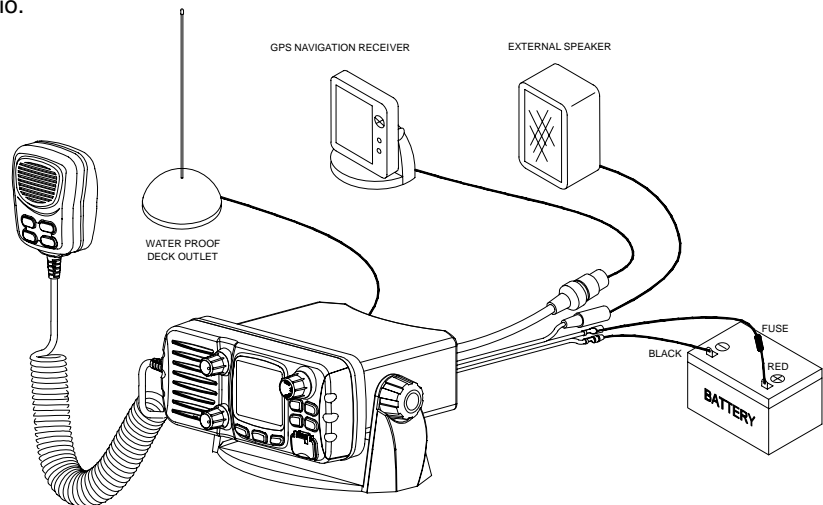

3.4 MOUNTING THE RADIO

Mount the radio on your vessel:

1. Find an appropriate location defined in section 3.2;
2. Place the mounting bracket on the location surface, use a pencil to mark the location of four holes where the fixing screws are to go into;
Caution: Be careful not to drill through the mounting surface.
3. Remove the bracket, drill four holes smaller than the screw diameter, then re-place the mounting bracket on the surface aligning the drilled holes;
4. Insert the four fixing screws and secure the bracket to mounting surface using the supplied bolts, spring washers, plain washers and nuts;

Caution: if you can not reach behind the mounting surface to attach the nut on the bolts, use the supplied self-tapping screws to fasten the bracket.

7. Insert the four fixing screws and fasten them with a Philip screw driver with attention not to screw too tightly;
8. Mount the base station onto the bracket with notice of the matching of the protuberances on the both inner side of the bracket and the pits on the two sides of the base station (the selectable pits on the sides of the radio allow you adjust the direction of the radio face to satisfy your easy-to-read-and-use, 15° for each rotation and totally 45° tolerance);
9. Attach the supplied mounting knobs from the two sides of the bracket to fixing the base station securely.

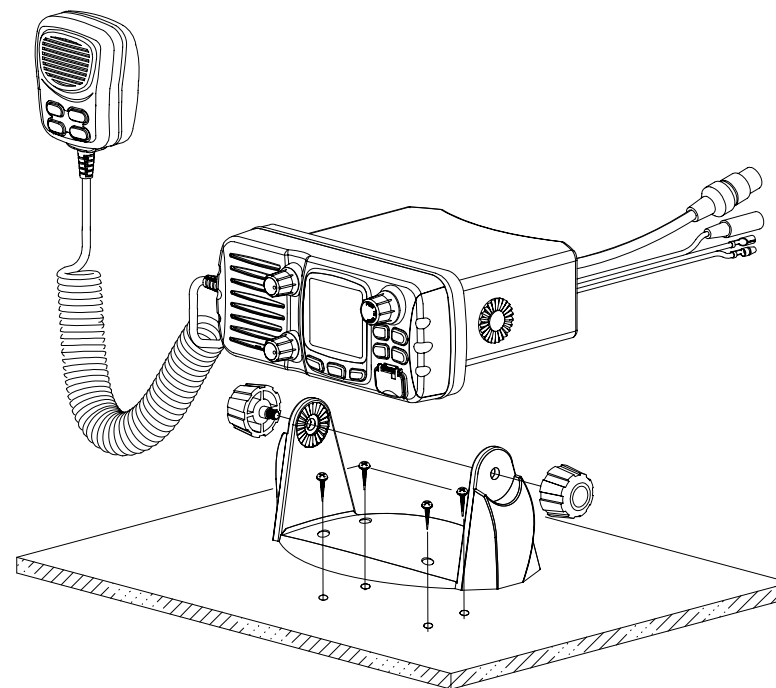

10. **Caution: Keep the radio and handset at least 1 meter away from any magnetic devices such as compass on your vessel.**

The supplied universal mounting bracket allows you to mount your base station from overhead or on dashboard with a big scope of angle as many as 45°.

Change the angle after installation:

11. Loosen the mounting knob at the sides of gimbal first.
12. Then adjust the base station to an appropriate direction with matching of the protuberances on the inner sides of gimbal and pits on the outer sides of base station.
13. Tighten the knob to secure.

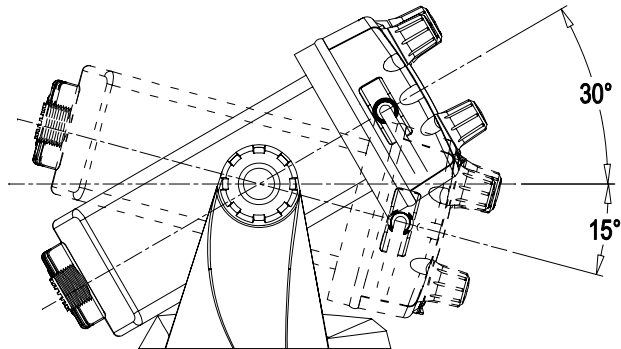

3.5 ANTENNA MOUNTING/THE EME EXPOSURE

For optimal radio performance and minimal human exposure to radio frequency electromagnetic energy, make sure the antenna is:

- Connected to the radio before transmitting;
- Properly mounted;
- Locate where it will be away from people;
- Locate at least three feet (91 cm) from the Base Station transceiver and Handsets;
- Use standard type of PL259 connector

3.6 MOUNTING THE HANDSET

Find a mounting location near the base station to mount the wall hanger for handset. The distance between the base station and the wall hanger should be less than the length of the handset cable.

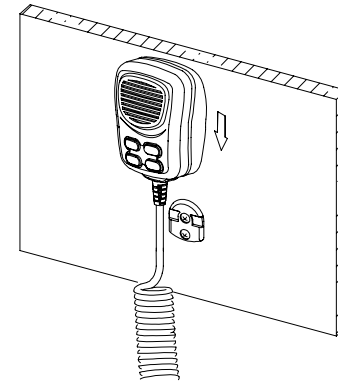

4. BASIC OPERATION

4.1 TRANSMISSION AND RECEPTION

CAUTION: Transmitting without an antenna may damage the radio.

- 1) After the radio has been installed, make sure of the power supply and antenna being properly connected.
- 2) To rotate the **VOLUME/POWER** knob clockwise turn on the radio and select a comfortable volume level.
- 3) To turn the **SQUELCH** knob clockwise until the background noise disappears.
- 4) Rotate **CH** knob to select channel
- 5) Press **Hi/Lo** button to select high power or lower power.
- 6) Press the **PTT** (Push-To-Talk) button on the handset to make the radio into transmission mode. the **T** indicator on LCD is displayed.
- 7) Speak clearly in a normal voice into the microphone.
- 8) Once the transmission is finished, release the **PTT** button. The radio is at receive mode, icon **R** appear on screen.

4.2. BAND SWITCH

4.2.1 USA AND INT MODE

- 1) Press the **BAND/SAVE** button, to switch the operational channel band (USA & INT).
- 2) The icon **USA** will be displayed on the LCD for USA mode, the icon **INT** will be displayed on the LCD for INTL mode, Briefly press the button to toggles between USA and INT band.

4.2.2 MEMO (FAV) MODE

Press and hold the **HI/LO/MEMO** button while in normal operation mode to enter Mem mode, icon  indicators appear on LCD. (Entering in Memo mode before at least one favorite channel must be stored firstly)

On the Mem Mode rotate the **CH** knob displays only the channels that you have saved to memory, which enables you to easily use your favorite channels while bypassing unwanted or seldom- used channels during a scan.

While in Mem Mode:



Press and release the **SCAN** button to start Memory scan mode.

Press and release the **SCAN** button again to stop Memory scan mode.

4.3 SAVE MEMORY (FAV) CHANNELS

You can store all band channels as favorite channel.

Program the FAV channel and store Process as follow:

- 1) At normal mode, tune to the desired channel and then press and hold the **BAND/SAVE** button to save it as Favorite channel. The icon  will be turned on for indication that channel be saved in FAV list.
- 2) Then tune to next desired channel and repeat the button operation till all desired channels be programmed / saved.
- 3) Delete the channel from the FAV list at Normal mode. Select the specified channel with icon  ON. Press and hold the **BAND/SAVE** button till the icon  turn OFF. The specified channel will then be deleted out from the FAV list. Repeat the button operation for those unwanted channels.
- 4) If no channel has been programmed, an error beep occurs with indicate error message.

4.4 TRANSMIT TIME-OUT TIMER (TOT)

When the **PTT** button on the microphone is held down, transmit time is limited to 5 minutes. This will avoid unintentional transmissions. About 10 seconds before automatic transmitter shutdown, a warning beep will be heard from the speaker(s). The transceiver will automatically go to receive mode. Before transmitting again, the **PTT** button must be released and then pressed again.

4.5 SCAN

Scanning is an efficient way to locate signals quickly over a wide frequency range.

The transceiver has 4 Scan modes available: All scan, FAV CH scan, Priority scan, and Priority FAV CH scan.

- 1) Briefly press the **SCAN** button to default all scan (1.2.3.4...).
- 2) Press and hold **SCAN** Button over 3sec, the Priority scan icon (1, 16, 2, 16, 3, 16...) will be selected. "Pscan" will be appeared on LCD. Press **SCAN** again, to turn it back to normal scan,

- 3) During the SCAN modes:

Press SCAN button again will terminate the scan operation and stop at the last used channel.

Press CANCEL button will also terminate the scan. It also can be to cancel by 16 or PTT.

- 4) FAV CH SCAN: If there are favorite channels stored, the scan (including all SCAN and PSCAN will be scanned only between these favorite channels)

4.6 WATCH

4.6.1 DUAL WATCH

Press **Watch** button to activate the DUAL WATCH mode. Monitor the current channel and Ch 16 in cycle. Icon  will appear on the LCD. Weather Alert is also activated automatically.

4.6.2 TRI-WATCH

Press and hold **Watch** button to activate the TRI WATCH mode. Monitor the current channel, CH 16 and CH 9 in cycle. Icon  will be turn ON
To quit the mode, press WATCH, **16**, CANCEL button,
Press **PTT** button to TX mode of current channel

4.7 POSITION INDICATION

Your transceiver can display the position of the vessel's (longitude and latitude) as well as time information, if connected to a GPS receiver. If no GPS equipment to be connected, an alert tone of 10 sec duration witch can be cancelled by any button will sound at 4 hour intervals to encourage manual input of positional data . Once no manual GPS input is made for 23.5 hours, "No GPS Information" will disappear from the screen. The position data transmitted goes to 9's and all the time data goes to 8's.

DISTRESS 23°20.1234 N 100°15.1002 E 08:10PM LOC
--

4.8 INTERCOM (Internal Communication)

The intercom feature lets you call and communicate with wireless handset subscribed to the radio

4.8.1 Start Intercom

Both base station and wireless handset can start Intercom:

1. Base station: Hold down the **Cancel/IC** button until the LCD appears the dialogue “intercom ENT→Accept”, **push CH** to start intercom
Notes: If there is no subscribed wireless handset power on, LCD will appear “No Remote” to indicate no remote handset active.
2. Wireless Handset: press the **Intercom** button on the side of handset, until the LCD appears the dialogue “INTERCOM BASE STATION, PRESS ENT”, press **ENT** to start intercom

4.8.2 Internal communication

while the intercom had been build, LCD of both base station and wireless Handset will appears “IC”

Base station and wireless handset can communicate with each other. Press “PTT” to transmit own voice, and release to listen the opposite voice

Press **IC** again or **16** button both in base station and handset to terminate the internal communication

5 DIGITAL SELECTIVE CALLING

5.1 GENERAL

DSC(Digital Selective Calling) is a semi-automated method of establishing a radio call, it has been designated by the International Maritime Organization (IMO) as an international standard for establishing VHF, MF and HF radio calls. It had also been designated part of the Global Maritime Distress and Safety System (GMDSS). It is planned that DSC will eventually replace aural watches on distress frequencies and will be used to announce routine and urgent maritime safety information broadcasts. This new service will also allow mariners to initiate or receive distress, urgency, safety and routine calls to or from another vessel equipped with a DSC transceiver.

5.1.1 MARITIME MOBILE SERVICE IDENTITY

An MMIS is a nine-digit number used on Marine Transceiver capable of using Digital Selective Calling (DSC). This number is used like a telephone number to selectively call other vessels. Refer to section 6.12 (USER MMSI ENTRY).

5.1.2 HOW CAN I OBTAIN A MMSI ASSIGNMENT?

Contact your dealer or NAVICOM

WARNING

This radio is designed to generate a digital maritime distress and safety call to facilitate search and rescue. To be effective as a safety device, this equipment must be used only within communication range of a shore –based VHF marine channel 70 distress and safety watch system. The range of signal may **vary** but under normal conditions should be approximately 20 nautical miles.

5.2 DSC CALL TYPES

Press the **DSC/MENU** button to pop up the menu for user to select the DSC call type to send. Note that only three calls can be shown at any one time on the screen.

Press **+/-** or rotate the **CH** knob scroll up and down the call types until the cursor is positioned at the desired option.

Press the **CH** button the call types are:

Call Type	Description
<i>LAST CALL</i>	Recall last call no matter what type of call received at last.
<i>NEW CALL</i>	Make a new call, by inputting the MMSI or pick up from the list max 20
<i>GROUP</i>	Sends transmissions that are only received by radios that share a common group MMSI number, up to 3 group MMSI numbers can be stored and call.
<i>ALL SHIPS</i>	Make an Urgency, Safety or Distress call to all ships. A re-confirmation screen follows the priority selection of Urgency, Safety or Distress. Such call will be sent out when assistance need but the situation not is so serious enough for a Distress Call. Urgency call is made when assistance required but not life endanger while Safety call is for advisory alert.
<i>CALL LOG</i>	Allow a review of all stored Calls by number and time of call. An individual call type can be placed to the selected MMSI/NAME in the LOG. The LOG maintains all received call types except DISTRESS calls. The call at the end of the list is automatically erased. The earliest call stored at the end of the list. There is 20 calls could be stored.
<i>DISTRESS LOG</i>	Allow a review of all stored Distress calls by number and time of call. An individual call type can be placed to the selected MMSI / NAME in the LOG. The call at the end of the list is automatically erased. The earliest call stored at the end of the list. There is also 10 calls could be stored.
<i>POS REQUEST</i>	The option enables you to request GPS position information from any vessel for which an MMSI-number is known, such request can pick up from buddy list.

DISTRESS
item deleted

EXIT quit the menu mode.

5.2.1 SENDING A DISTRESS CALL

Note: Only having a MMSI code of your radio and DSC enable, you can initiate a DSC transmission. To enter the MMSI code sees 6.9.1.

- 1) Open the red cover labeled DISTRESS.
- 2) Press the **DISTRESS** button momentarily.
The Text area of the display reconfigures to show the Nature of Distress menu.



- 3) If time is available, rotate the **CH** knob to select the Nature of Distress, the default are "**UNDESIG**".
- 4) Hold down the **DISTRESS** button for more than 3 seconds until you see the distress call sent message on the screen. The whole display screen starts to flash and beep loudly.
- 5) If **DISTRESS** button is released before 3 seconds, the initiation of distress call is not taken into effect and If button is pressed for more than 3 seconds, Distress call is sent whether channel 70 is busy or not. When Distress is sent, the acoustic alarm goes to a continuous tone until acknowledgement received or the Distress call is cancelled.
- 6) During the distress call sequence, the radio simultaneously watches Channel 70 for a DSC acknowledgement and Channel 16.
- 7) When the distress call is acknowledged, the acoustic alarm stops and the radio returns to normal operation on channel 16, with high power relay to the connected station via the microphone
- 8) If no acknowledgement is received, the unit retransmits the Distress call at random intervals of 3.5 to 4.5 minutes until a response is received or the call is manually cancelled, by pressing **CANCEL** button for twice

5.2.2 SEND AN ALL SHIPS CALL

- 1) Press **DSC/MENU** button. Rotate the **CH** knob to select "ALL SHIPS". Press the **CH** knob to enter ALL SHIPS. The All Ships menu displays LCD the categories from which you can select .

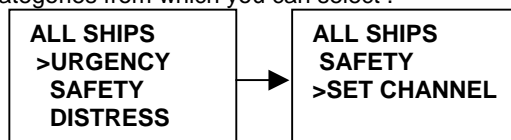

- 2) Rotate the **CH** knob to select: SAFETY, presses the CH knob to enter All Ships Safety send.



- 3) Rotate the **CH** knob to select the working channel; or press **16** button to quit.
- 4) Press again and release the **CH** knob to advance the screen if send the call.
- 5) Press again and release the **CH** knob to sending all ships safety call.
- 6) Once the call is sent, the text area of the display momentarily shows the Calling All Ships message. And then the radio returns to normal VHF operation on the designated channel. Press **PTT** to talk.

5.2.3 SEND A GROUP CALL

This feature allows the user to contact a group of specific vessels using DSC and to automatically switch to a desired channel. Before sending a GROUP call, you must be set the GROUP MMSI

- 1) From the DSC/MENU select the GROUP CALL item. Press the **CH** button, the screen displays the names of your groups.

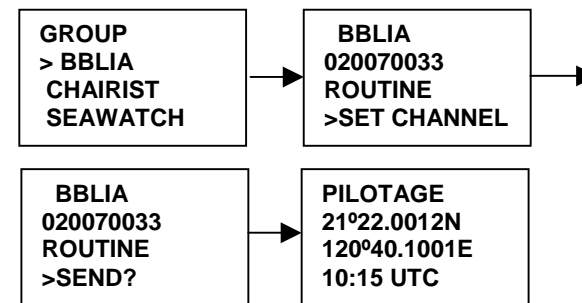

- 2) Select the group that you want to call. Then select the channel Press the **CH** knob to send a group call, Once the call is sent, the Text area of the display momentarily shows the Calling group message.
- 3) After the GROUP CALL is transmitted, the radio will return to normal VHF with the designated channel.
- 4) Press the **PTT** to start talk.

5.2.4 MAKE A ROUTINE CALL (INDIVIDUAL)

You can make an individual call, either to a ship or to a boat station.

5.2.4.1 MANUALLY SENDING AN INDIVIDUAL CALL

- 1) Press **DSC /MENU** to DSC mode, then select "NEW CALL". Press the **CH** knob The arrow is pointing to **<ROUTINE>**



- 2) Rotate the **CH** knob to select: SAFETY, press the **CH** knob the arrow is pointing to **<MANUAL>**
- 3) Press the **CH** knob again access manual enter ID screen, enter the MMSI number using the **CH** knob, when MMSI entry is complete, press the **CH** knob to accept the selection
- 4) Then rotate the **CH** knob to select the working channel and press the **CH** knob to accept select.
(Only in the case of a call to a ship, it is permitted to enter a talk channel; a call to a coast station, the coast station will specify the channel to talk on in its acknowledgement.)
- 5) The radio summarizes the call details and asks for confirmation to send the call (send?).
- 6) Press the **CH** knob again to send the call. The radio goes to CH 70 and the icon-T is displayed on the screen while the DSC call is being sent, then LCD display an awaiting acknowledgment.



- 7) If the call is acknowledged (ACK), press PTT to talk
- 8) If the call does not get with in 30 seconds, the radio prompts you to resend the call.
- 9) If you do nothing for 5 minutes, the individual call cancelled and the radio revert to the original channel.

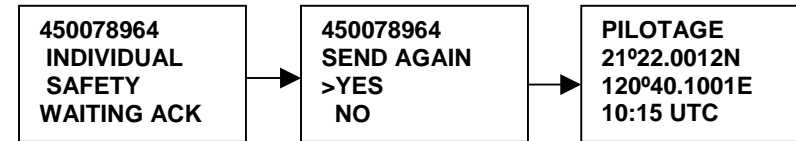

5.2.4.2 SENDING AN INDIVIDUAL CALL (MMSI STROED IN BUDDY LIST)

- 1) Press **DSC /MENU** to DSC mode, then select "NEW CALL". And next select one of categories from new call menu. Press the **CH** knob, the arrow is pointing to **<MANUAL>**
- 2) Rotate the **CH** knob select the person of the Buddy list that you want to call. The procedures are as same as manual send an individual call.

5.2.4.3 ACKNOWLEDGEMENT OF AN INDIVIDUAL INCOMING CALL

The EUR requires the operator to manually send an acknowledgement to the requesting radio. Press **CH** knob to send an acknowledgement or **CANCEL** button to cancel.

The USA will automatically send an acknowledgement to the requesting radio within 10 seconds of receiving the call.

5.2.5 LAST CALL (RECALL THE MOST RECENT INCOMING CALL)

This facility also is useful and is used frequently as routing individual call

- 1) Press the **DSC / Menu** button to enter the DSC mode LAST CALL will be pointed, press **CH** knob to display the detail information of the last call
- 2) Select the working channel for individual call and press **CH** knob, the radio summarizes the call details and ask for confirmation to send the call (send?). Press **CH** knob to send the call other operation as same as the section 5.2.4.1

5.2.6 SEND CALL USING THE CALL LOG

The CALL LOG contains the contact details for the 20 most recent incoming calls, so you call any of them again quickly

- 1) Press the **DSC / Menu** button to enter the DSC mode, select **CALL LOG**, Rotate the **CH** button to scroll for previous call.
- 2) Press the **CH** knob to conform the choice then follow the as the ways to make the call in 5.2.4.1
- 3) You can choose **SAVE MMSI** to store the vessel MMSI from the call log

5.2.7 SEND CALL USING THE DISTRESS LOG

Total max.10 distress call data could be stored; the oldest one will be erased. The feature is similar to CALL LOG function, but selects the caller from the Distress Log.

- 1) Press the **DSC / Menu** button to enter the DSC mode, select **DIST LOG**, Rotate the **CH** button to scroll for previous call.
- 2) Press the **CH** knob to conform the choice then follow the as the ways to make the call in 5.2.4.1
The details are displayed over two screens that alternate every 1.5 seconds; the first screen shows the location and name or MMSI of the vessel in Distress, the second screen shows the nature of the emergency (if specified) and the MMSI of the vessel that relayed the Distress Call

- 3) You can choose **SAVE MMSI** to store the vessel MMSI from the Dist log

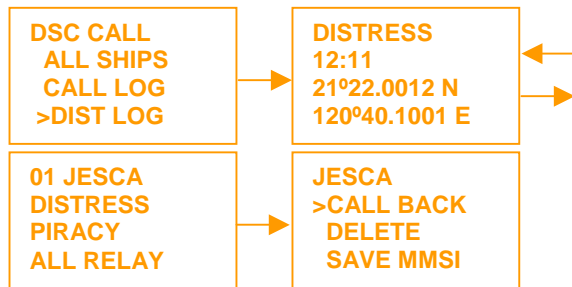

- 4) After selection of the previous Distress call, you can Relay it by the two way of INDIV RELAY and ALL RELAY. Ref. to the examples below:



5.2.8 POS REQUEST AND POS REPLY

5.2.8.1 POS REQUEST (REQUEST THE LL POSITION OF A BUDDY)

The option enables you to request GPS position information from any vessel for which an MMSI number is known.

- 1) Select the POS REQUEST on the DSC Menu, press the **CH** knob to enter the buddy list, select the one for position information.
- 2) The Call will be initiate and same as individual call procedures. See 5.2.4.1

5.2.8.2 POS REPLY

The position relay can to send your position to another radio with this feature. Your radio must have an operating GPS receiver connected to be used to send to the position.

POS reply can manually send your position or do it automatic t which depending upon on your setting the set

On the manual reply, operation procedures as follow:

- 1) when you received POS request call, An alarm (pi-pi) sounds, LCD displays as follow:
- 2) Press the **CH** knob to transmit your own ships' position and time information
- 3) Press **CANCEL** to record the received information, then the screen goes back to default.

5.3 RECEIVING A DSC CALL

When a DSC call is received, the radio automatically responds based on the type of call. The information displayed on the LCD varies depending upon the call type. See chart below.

5.3.1 RECEIVING DISTRESS CALL

- 1) When a distress call is received, the radio automatically tunes to channel 16, and the Distress Alarm Tone sounds. The call date is stored in the **Distress Log** and able to output to the NMEA port for external Chart-plotter. Pressing any button disables the alarm.
- 2) When position data is included within the signal, it is displayed in the Text Area of the LCD. When no position data is included within the signal, the message "99°99.999 X 99°99.999 Y 88:88" is displayed in the Text Area of the LCD.
- 3) You must continue to monitor channel 16 as a coast station may require assistance in any rescue attempt

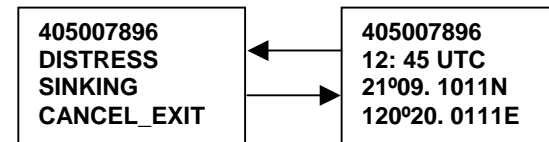

5.3.2 RECEIVING A DISTRESS ACK SEND FROM A COAST STATION

- 1) When a Distress Relay Call is received, the Base Station automatically tunes to Channel 16, and the Distress Alarm Tone sounds. Pressing any button disables the alarm.

When position data is included within the signal, it is displayed in the Text Area of the LCD. The call date is stored in the **Distress Log** and able to output to the NMEA port for external Chart-plotter.

- 2) You must continue to monitor channel 16 as a coast station may require assistance in any rescue attempt.

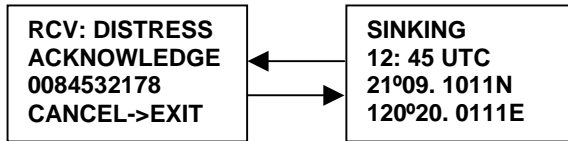

5.3.3 RECEIVING DISTRESS RELAY CALL

- 1) When a Distress Relay Call is received, the Base Station automatically tunes to Channel 16, and the Distress Alarm Tone sounds. Pressing any button disables the alarm. The call data is stored in the distress log and able to output to the NMEA port for external Chart-plotter. When position data is included within the signal, it is displayed in the Text Area of the LCD.
- 2) You must continue to monitor channel 16 as a coast station may require assistance in any rescue attempt.

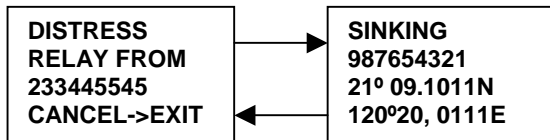

5.3.4 RECEIVING AN ALL SHIPS CALL

- 1) When an All Ships Call is received, the Alarm Tone Sounds, the radio manually tune to the designated Channel, and press any button to disable the alarm.
- 2) You must continue to monitor the channel so as to receiver the voice communication.
- 3) The call date is stored in the call log

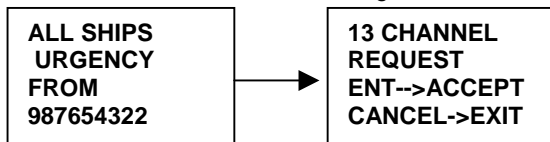

5.3.5 RECEIVING AN GROUP CALL

- 1) When an group Call is received, the Alarm Tone Sounds, the radio automatically tune to the designated Channel, and Press any button to disable the alarm.
- 2) Monitor the traffic channel for an announcement from the calling ship.
- 3) The call date is stored in the CALL LOG



5.3.6 RECEIVING AN INDIVIDUAL CALL

- 1) When an Individual call is received, the Alarm Tone Sounds The radio manually tunes to the channel designated in the DSC signal,
- 2) The MMSI contained within the signal are displayed on the Text Area of the display. If the MMSI correlates to an MMSI stored in the Buddy List, the corresponding name is displayed in place of the MMSI.
- 3) The DSC signal data is stored in the Call Log.

5.3.7 RECEIVING AN "POSITION Reply" CALL

- 1) When "Position Reply" received, the Alert tone sound and the "POSITION ACK" message on 1st line and display the sender GPS data.
- 2) The time & position could be stored and able to output to the NMEA port for external Chart-plotter.

5.3.8 RECEIVING A GEOGRAPHIC AREA CALL

- A GEOGRAPHIC AREA CALL are received by vessels by within a specific geographical boundary area.
- 1) When you receive notification of a geographical call, press any button to cancel the alert. The radio automatically selects the channel designated in the incoming call. The time and the user MMSI are displayed on the screen and the call date is stored in the call log
 - 2) Monitor the working channel for an announcement from the calling vessel.

6 SETUP MENU

6.1 MENU FUNCTION DESCRIPTION

The radio's setup functions are accessed through the Menu mode. Menu mode selections are as follows.

Item	Description
BUDDY LIST	Selects the Buddy List Entry routine to enter Names and MMSI's for frequently called DSC stations. Up to 20 names could be stored.
BACKLIGHT	Set the backlight level, total 8 level be available.
CONTRAST	Selects display contrast setting: 1-8 levels.
LOCAL/DIST	"DISTANT" allows normal receive sensitivity; and "LOCAL" eliminates receiver noise, but degrades receiver sensitivity meanwhile LOCAL icon displayed on LCD.
GPS/TIME	Set the Position info if no GPS attached and define the display POS and Time format, Offset, COG/SOG, display GPS alert settings.
RADIO SETUP	There are 5 items that user can customize – Language, CH Name, Ring Tone Volume, Button Beep Volume and INT Speaker On/Off.
DSC SETUP	There are 6 functions that allow user to alter – User MMSI entry, Group Setup, ATIS MMSI, ATIS ENABLE, DSC ENABLE, and POS Reply
 AIS SETUP	There are 2 items to setup the AIS display and output parameters
HS SETTING	Subscribe to link the wireless handset
RESET	Recall factory default setting
EXIT	Escape from the Setup Menu

6.2 SET-UP MENU NAVIGATION

1) To access the Menu Mode:

Press and hold **MENU/DSC** button, Text area displays the Set-Up Menu list.

2) To exit the Menu mode or sub –mode:

Press the 16 or CANCEL button or else select the EXIT option from the menu.

3) Rotate the **CH** knob to select the Item within the Set-Up Menu list To confirm a selected item for adjustment, push the **CH** knob.

When the desired setting is done, press the **CH** knob to enter the setting, and move back to the Main Menu list.

4) Set Up operation is exited by turning the unit off. All changes are saved in EEPROM.

6.3 BUDDY LIST

The Buddy List can store up to 20 entries with Name and MMSI. User can add, edit or delete the record from the list under this submenu.

6.3.1 ADDING AN ENTRY

- 1) Select Buddy List and the cursor is at <NEW> press **CH** knob entry page which prompt up to allow enter Name and MMSI.
- 2) Rotate the **CH** knob to select the first desired character (A-Z, 1-9, Space and Back Arrow ">") for the name. When the desired character is shown, push the **CH** knob to enter, Same select the next characters, The characters can be up to 12. When the last digit is entered, the activation advances to the first MMSI digit.
- 3) Enter the MMSI associated with that buddy name (this must be numeric) Prefix 00 will treat as Coast Once 9 digit be entered, pops up a new page to ask for confirmation to save.
- 4) Press the **CH** knob to save the new entry, which is displayed at the top of your BUDDY LIST.
- 5) Press **CANCEL** will terminate the process without saving go back to Buddy list page.
- 6) When the buddy list is full. you can make a new entry and the buddy at the end of the list is automatically erased.

6.3.2 EDIT EXISTING ENTRY

- 1) Pick up one from BUDDY list and edit Press **CH** knob one Page pops up item for you to edit or delete, Choose EDIT.
- 2) when you are finished editing. Press **CH** knob into a new page prompt in to ask for confirmation to save.

- 3) Press the **CH** knob to save the new edit. The BUDDY list is displayed again. If more changes are required repeat steps from 1 to 3 otherwise, press cancel to exit.

6.3.3 DELETE AN ENTRY

- 1) Select the one which you want to delete from the list.
- 2) Rotated the **CH** knob to select the Delete option.
- 3) Press and hold the he **CH** knob to confirm the delete action.
- 4) The selected record will be removed and go back to BUDDY list page. You can repeat steps from 1to 4 to delete more records, or press cancel to exit.

6.4 BACKLIGHT ADJUSTMENT

- 1) Select **BACKLIGHT** and press the **CH** knob. There are 8 levels control for the BACKLIGHT.
- 2) Rotate the **CH** knob to adjust the setting, Press the **CH** knob to permanently enter the setting and return to the MENU LIST.

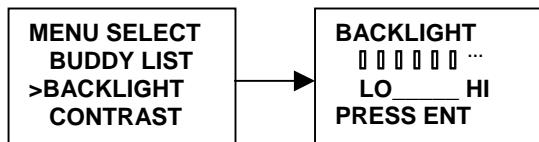

6.5 CONTRAST ADJUSTMENT

- 1) Select **CONTRAST** and press the **CH** knob. There are 8 levels control for the contrast.. The higher numbers the darker LCD
- 2) Rotate the **CH** knob to adjust the setting, Press the **CH** knob to permanently enter the setting and return to the MENU LIST.

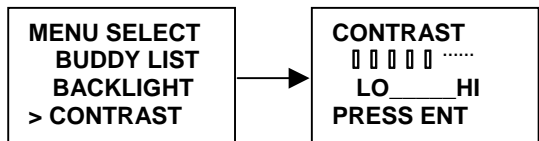

6.6 LOCAL/ DISTANT

You can set the receiver to LOCAL to eliminate noise, select the LOCAL/DST from the MENU list for local and press the **CH** knob. The local state is stored when screen is exited. The **LOCAL** icon turns ON in the LCD. Default is DISTANT

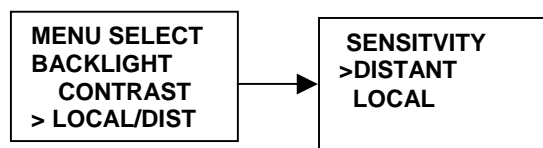

6.7 GPS/TIME

The radio automatically detects NMEA strings and decodes appropriate latitude/longitude position and time. If the GPS navigation receiver is not connected on or is not functional, a manual latitude/longitude position and UTC should be entered and used in the DSC distress transmitted message. When valid Lat/Lon information is detected, the data is display on the LCD, when there is no valid position information, NO GPS INFORMATION appears.

6.7.1 MANUAL ENTER GPS DATE

If no GPS data is available, the NO GPS INFORMATION appears, and after 2 minutes PLEASE INPUT POSITION! is displayed with NO GPS, Alarm sounds for 10 sec or till any button is pressed.

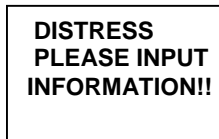

The manual entry function is just valid if and only if no GPS connected

- 1) Select GPS/TIME then manual
- 2) Enter the latitude, then the longitude, then the UTC.
- 3) Press the **CH** knob, when all the information is correct.

The vessel's lat/Lon with the UTC time are shown on the screen. The manual entries are cancelled if a real GPS position is received.

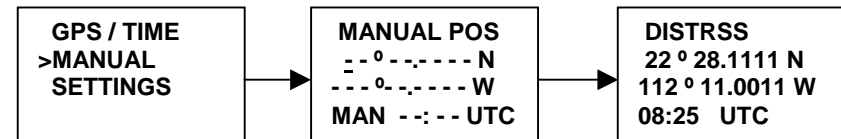

6.7.2 SETTINGS

You can also set what time and position information is display on the screen

- Whether Position date is displayed
- Whether the time is displayed
- Whether a Time Zone Offset is used
- How the time date is formatted
- Whether COG/SOG date is displayed
- Whether GPS alert is on/off

6.7.2.1 POSITION DISPLAY ON/OFF

You can choose the position data displayed on the normal mode or not

- 1) Select GPS/TIME then SETTINGS, then POS DISPLY

- 2) Select ON(on) or OFF(off)as desired, this is example, selected on and the screen shows the vessel position.

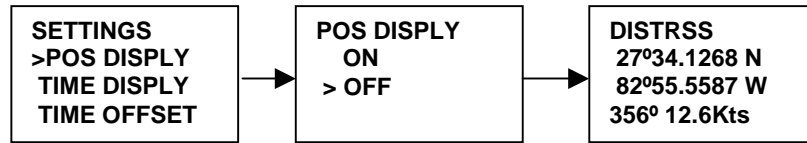

6.7.2.2 TIME DISPLAY ON/OFF

You can to turn on/off the time displayed at the normal mode

- 1) Select GPS/TIME then SETTINGS, then TIME DISPLY
- 2) Select ON(on) or OFF(off)as desired, in this example, selected on and the screen shows the vessel TIME.

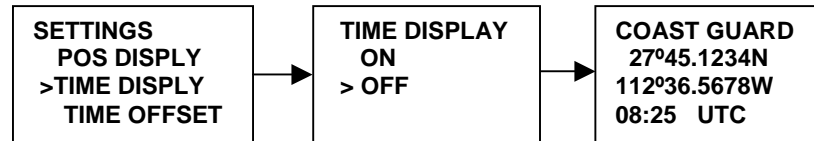

6.7.2.3 LOCAL TIME (TIME OFFSET)

You can set the add/subtract value from UTC time to equal to local time. When offset value is added, the time will be displayed as LOC instead of UTC

First to set the offset direction + or – and then value in ½ hr. step. The updated result will be displayed immediately

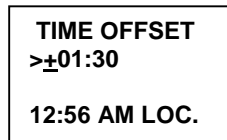

6.7.2.4 TIME FORMAT OPTIONS (TIME FORMAT)

You can choose display time in 12 hr or 24 hr format...

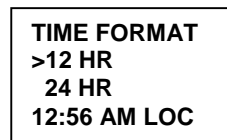

6.7.2.5 COURSE/SPEED DISPLAY OPTIONS (COG/SOG)

You can enable COG (Course over Ground) and SOG (Speed over Ground) displayed on normal mode.

If the TIME DISPLAY is turn ON, COG/SOG will be turned off automatically since it share the same bottom line for display.

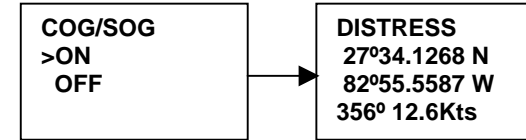

6.7.2.6 GPS ALERT

You can choose NO GPS DATA alarm sound is on/off.

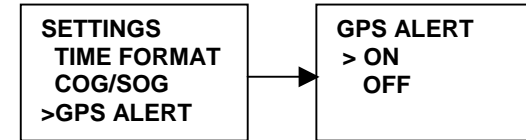

6.8 RADIO SETUP

Under Radio Setup submenu, there are 5 items that user can alter settings including Language; CH name; Ring Volume; Button beep; INT Speaker

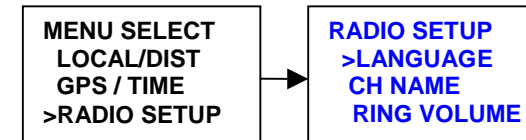

6.8.1 LANGUAGE SELECTION

Select the Menu language in English or French as desired

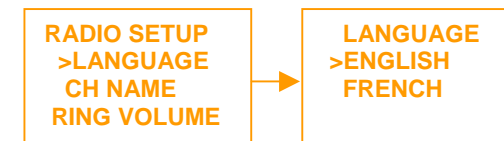

6.8.2 CHANNEL NAME DISPLAY AND EDITING

To set the channel name for ON or blank, on the first line. Maximum of 12 characters could be set for channel name. Channel name also allows editing, the ways same as Buddy List edit procedures. The following is operated in CH 5 as example.

6.8.2.1 CHANNEL NAME DISPLAY

- 1) Select RADIO SETUP then CH NAME, then “DISPLAY NAME”
- 2) Select ON (on) or OFF (off) as desired, this is example, select on and press the **CH** knob the screen shows the channel name.

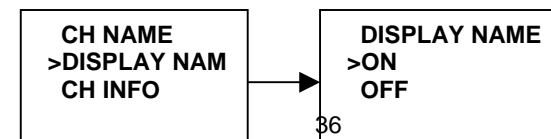

6.8.2.2 CHANNEL NAME EDITING

- 1) Select RADIO SETUP then **CH** NAME, then **CH** INFO, Select the desired channel name by **CH** knob and then press the **CH** knob the screen shows the channel name and EDIT and DELETE.
- 2) Select EDIT and press the **CH** knob to edit the existing name tag, Input the new name over the existing name and press the **CH** knob to display the YES/NO conformation
- 3) Press the **CH** knob to confirm the new channel name then press cancel to return to the menu.

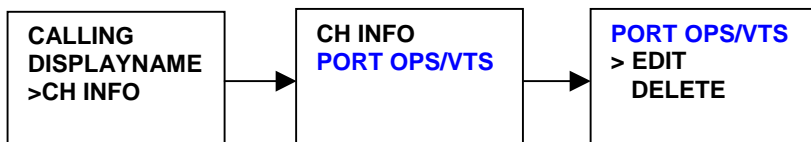

6.8.3 RING VOLUME ADJUSTMENT

- 1) Select the RING VOLUME by **CH** knob and then display the option – HIGH and LOW as ringer tone setting.
- 2) Press The **CH** knob button again to confirm the changes.

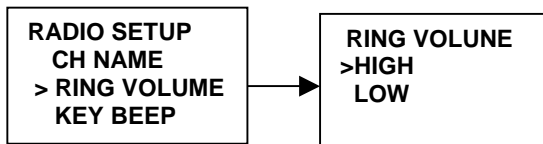

6.8.4 KEY VOLUME ADJUSTMENT

- 1) The key beep tone volume level. Select the **KEY BEEP** by The **CH** knob and then display the option – HIGH, LOW & OFF as key beep setting.
- 2) Press The **CH** knob button again to confirm the changes.

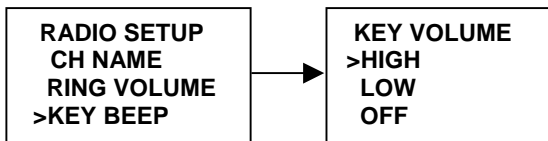

6.8.5 INT SPEAKER OPERATION

- 1) Select RADIO SETUP then INT SPEAKER.
- 2) Select ON (on) or OFF (off) as desired.

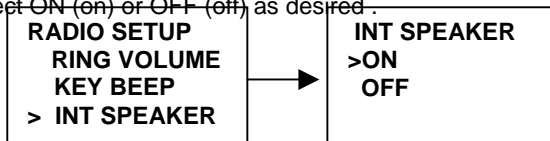

6.9 DSC SETUP

The submenu is used to set behavior of the DSC/ATIS function. The following 6 items are available for selection.

- User MMSI
- Group Setup
- ATIS MMSI
- ATIS ENABLE
- DSC ENABLE
- POS REPLY

6.9.1 ENTER YOUR USER MMSI (USER MMIS)

This is a once-only operation.

You must enter your user MMSI first then you can access the DSC functions.

- 1) Select DSC SETUP then USER MMSI and press the **CH** knob. If an existing MMSI is stored, the values appear.
- 2) If the MMSI is blank, a dashes-line appears. Enter user MMSI along the dashed line. Press the **CH** knob to confirm each correct entry to move to the next digit.
If your make an error, press –until < appears, then press the **CH** knob to backup and correct the entry.

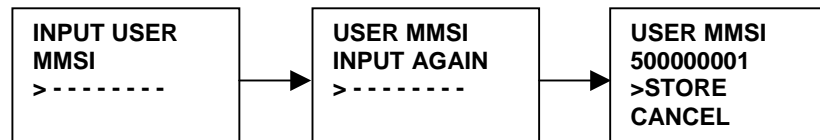

- 3) Hold the **CH** knob to store your user MMSI.
- 4) Enter your user MMSI again as a password check, hold the **CH** knob to permanently store the your user MMSI and return to the menu.
- 5) You can view your stored user MMSI at anytime by selecting user MMSI in the DSC SETUP menu.
- 6) If there is no USER MMSI stored and the radio's DSC function is attempted, the radio says "PLEASE INPUT USER MMSI" as below.

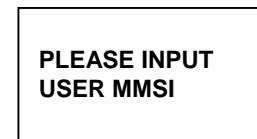

DSC WARNING MESSAGE

6.9.2 MAINTAIN GROUPS

You can program up to three group MMSI numbers and associated Group names, group MMSI numbers always begin with a zero (0). You only enter the last 8digits of the group ID number, the intial"0" is automatically entered.

6.9.2.1 ENTER YOUR GROUPS

- 1) Select GROUP SETUP and the cursor is at <MANUAL NEW>. If an existing names & MMSI data are stored, the values appear.
- 2) If is blank, Only MANUAL NEW appear on LCD
- 3) The entry procedures are same as that of the BUDDY LIST.

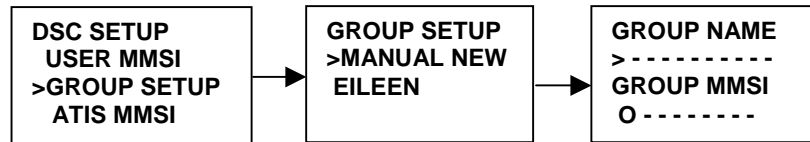

6.9.2.2 EDIT USER GROUPS

- 1) Select DSC SET/UP then GROUP SETUP and press the **CH** knob. The existing names & MMSI data are displayed on screen. Select the Group name or, only the MMSI that you wanted
- 2) Press the **CH** knob to edit.. The entry procedures are same as that of the BUDDY LIST
- 3) when the edition is finish press the **CH** knob to store the changes and return to the GROUP MMSI screen.



6.9.2.3 DELETE A GROUP

- 1) Select GROUP SETUP and press the **CH** knob. The existing group names are displayed on screen
- 2) Select that you wanted delete and press the **CH** knob will display EDIT or DELETE item
- 3) Select DELETE and press the **CH** knob will display DELETE GROUP menu arrow point the YES, then press the **CH** knob to empty the group and return to the GROUP SETUP screen. The LCD displays the group as follow.



6.9.3 ENTER YOUR ATIS MMSI

This is a once-only operation.

You must enter your ATIS MMSI first then you can access the ATIS functions.

- 1) Select DSC SETUP then ATIS MMSI and press the **CH** knob. If an existing MMSI is stored, the values appear.

- 2) If the MMSI is blank, a dashes line appear, except for the initial '9' Enter ATIS MMSI along the dashed line. Press the **CH** knob to confirm each correct entry to move to the next digit. If you make an error, press -until < appears, then press the **CH** knob to backup and correct the entry.

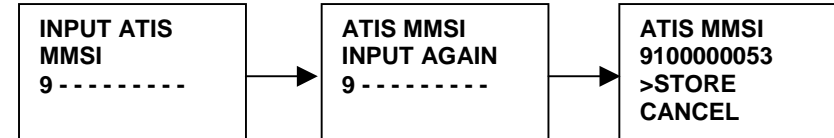

- 3) Hold the **CH** knob to store your ATIS MMSI.
- 4) Enter your ATIS MMSI again as a password check, hold the **CH** knob to permanently store the your ATIS MMSI and return to the menu.
- 5) You can view your stored ATIS MMSI at anytime by selecting ATIS MMSI in the DSC SETUP menu.

6.9.4 ATIS ENABLE

When ATIS is enabled, the following occurs:

DSC functions are disabled.

DUAL watch, Tri Watch and scan functions are disabled.

The following international channels are limited to 1 watt output power:

6,8,10,11,12,13,14,15,17,71,72,74,75,76,77(and 31, if enabled)

To enable/disable ATIS:

- 1) Select DSC SETUP, then ATIS ENABLE, Press the **CH** knob to displays ATIS ENABLE ON/OFF.
- 2) Select ON for turn on ATIS function.
- 3) Press the **CH** knob to confirm your choice and return to the menu.

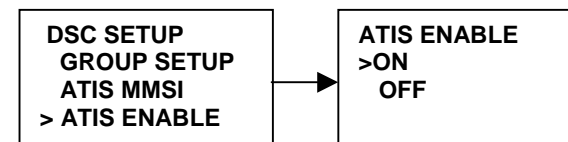

6.9.5 DSC ENABLE

Temporarily turn off the DSC function, such as sailing to inland water or no DSC region.

- 1) Select DSC SETUP, then DSC ENABLE, Press the **CH** knob to displays DSC ENABLE ON/OFF.
- 2) Select OFF for turn off DSC function. "DSC" icon on LCD will disappears
- 3) Ppress the **CH** knob to confirm your choice and return to the menu.

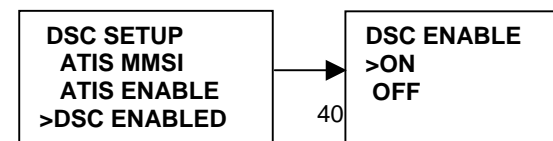

6.9.6 POS REPLY

You can set the radio to respond the Position Request. In the one of three ways: automatic, manual, off.

- 1) Select DSC SETUP, then POS REPLY. Then press the **CH** knob, the MANUAL, AUTO, OFF appear on the screen.
- 2) Select your response and press the **CH** knob to confirm and return to the menu manual,

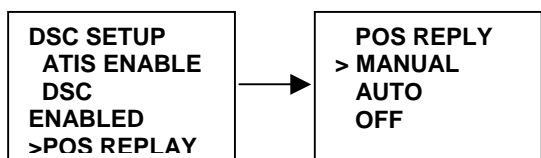

6.10 AIS SETUP

AIS setup and display, please ref. to Chapter 7

6.11 HS SETTING

Linking to wireless Handset, please ref. to section 4.8 and Chapter 8

6.12 RESET

This feature resets every setting to the factory defaults, except USER MMSI and GROUP MMSI, ATIS MMSI. And Buddy list.

- 1) Select RESET, press **CH** button, the radios asks for confirmation
- 2) Select yes, press **CH** button to reset the radio and return to the menu.

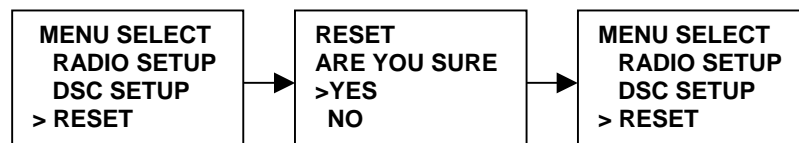

7 AUTOMATIC IDENTIFICATION SYSTEM (AIS) RECEIVER

DISCLAIMER

This product is designed to aid navigation and should be used to augment normal navigational procedures and practices. It is the users responsibility to

use this product prudently.

Neither Navicom, nor their distributors or dealers accept responsibility or liability either to the product user or their estate for any accident, loss, injury or damage whatsoever arising out of the use or of liability to use this product.

7.1 WHAT IS AIS?

AIS permit the non-verbal exchange of navigation information between vessels and shore-side vessel traffic centers. AIS uses digital radio signals to broadcast information about the vessel to other ships and shore based stations via dedicated VHF frequencies in the maritime band.

AIS will not replace radar because it is unable to detect landmasses and navigational beacons, but it can be used as a significant enhancement to currently available technology.

7.2 CLASSES OF AIS

Your Navicom radio RT-650 is a receive-only unit that will receive messages from vessels carrying Class A or Class B transceivers.

Class A

A Class A transceiver transmits and receives AIS signals. It is currently compulsory on all commercial vessels that exceed 300 tons that also travel internationally Information transmitted

The following information can be transmitted by a Class A AIS system:

Static data

This includes information such as Ship's name, type, MMSI number, call sign, IMO number, length and beam and GPS antenna location.

Voyage related data

This includes information such as draft, cargo, destination, ETA and other relevant information.

Dynamic data

This includes information such as time (UTC), ship's position, COG, SOG, heading, rate of turn and navigational status.

Dynamic reports

These are ship's speed and status.

Messages

These are alarms and safety messages.

You should remember that not all vessels will transmit all of the information.

Class B - (Recreational vessels not covered by suitable Class A)

Class B transceiver's are suitable to vessels under 65 feet in length and is not compulsory.

You should NOT assume that any class of AIS receiver is displaying all/any smaller vessels within your range.

Note: All messages contain the Ships individual MMSI number for unique reference identification purposes along with the data in the following table. Not all the information in the following table is necessarily transmitted by every vessel.

Data details	Class A	Class B
Static Data		
. Ship's name	✓	✓
. Type	✓	✓
. Call sign	✓	
. IMO number	✓	
. Length and beam	✓	✓
. GPS Antenna location	✓	✓
Voyage Related Data		
. Draft	✓	
. Cargo information	✓	✓
. Destination	✓	
. ETA	✓	
. Other relevant information	✓	✓
Dynamic Data		
. Time	✓	✓
. Ship's position	✓	✓
. COG	✓	✓
. SOG	✓	✓
. Gyro heading	✓	✓
. Rate of turn	✓	✓
. Navigational status	✓	
Dynamic Reports		
. Ship's speed	✓	✓
. Ship's status	✓	✓
Messages		
. Alarm	✓	✓
. Safety	✓	✓

7.3 STATIC AND DYNAMIC INFORMATION

Defined transmit rates for Class A vessels shown below are provided for reference purposes only. The frequency of messages received (using the AIS250 receive-only unit) will vary due to a number of factors including but not limited to such factors as antenna height, gain and signal interference.

- Static information is either broadcast every 6 minutes, when data has been amended, or upon request.
- Dynamic information is broadcast depending on speed and course alteration based on the following tables

Ships Dynamic Conditions	Normal reporting interval
At anchor or moored	3 Minutes
0 –14 knots	10 Seconds
0 –14 Knots and changing course	3 1/3 Seconds
14 –23 knots	6 Seconds
14 – 23 Knots and changing course	2 Seconds
Ship faster than 23 knots	2 Seconds
Ship faster than 23 Knots and changing course	2 Seconds

Platforms condition	Normal reporting interval
Class B Shipborne mobile equipment not moving faster than 2 Knots	3 Minutes
Class B Shipborne mobile equipment moving 2-14 Knots	30 Seconds
Class B Shipborne mobile equipment moving 14-23 Knots	15 Seconds
Class B Shipborne mobile equipment moving faster than 23 Knots	5 Seconds
Search and Rescue aircraft (airborne mobile equipment)	10 Seconds
Aids to Navigation	3 Minutes
AIS base station	10 Seconds

Source of information for above tables 1-1, 1-2: (ITU recommendations technical document: ITU-R M.1371-1)

7.4 AIS INFORMATION AND DISPLAY

NAVICOM radio can display AIS data for navigation on LCD, As well as output the AIS data to other NMEA compatible multifunction plotter or PC.

7.4.1 AIS DATA OUTPUT TO OTHER DEVICES

There are 2 choices for serial ports, one presenting NMEA (RS422) format and the other RS232 format, which is selected in AIS setup submenu of setup menu:



The default setting is RS232
The output data is a NMEA data sentence (VDM) string at 38.4K baud rate.

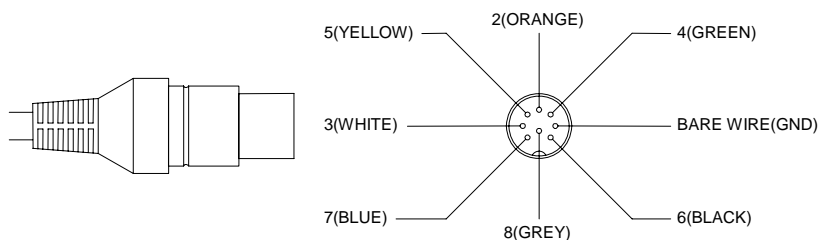

Wiring of RS232

Pin of cable	Cable Color	Signal Name
7	Blue	TX RS232
8	Grey	RX RS232
Bare wire	/	Grounding

Wiring of RS422

Pin of cable	Cable Color	Signal Name
7	Blue	+NEMA OUTPUT RS422
8	Grey	-NEMA OUTPUT RS422

7.4.2 AIS DATA DISPLAYED IN MARINE RADIO

AIS data also can be displayed on your marine radio, to aid navigation with monitoring the position, details and navigational intentions of other vessels within VHF range

7.4.2.1 AIS DATA DISPLAY FORMAT

AIS display has ship Name or ship MMSI displaying at AIS List mode. User can set whether display, in the format of Ship MMSI or Ship Name.



7.4.2.2 AIS DATA DISPLAY MODE

There are 3 mode concerning the AIS information:

Plotter mode

List mode

Information mode

Notes: Press 16, PTT, Distress will return to normal mode in all 3 modes.

----List mode

In non-menu mode, long pressing the 'CH' button to enter the List mode.

MMSI/NAME B/DnM	MMSI/NAME B/DnM
413461580 281' 3.3nM	CHANGJIAN 281' 3.3nM
477303000 285' 4.2nM	XIALONGHAO 285' 4.2nM
412462110 297' 5.3nM	XIAOWANG 297' 5.3nM
412462120 209' 5.4nM	WANGWEI 209' 5.4nM

Rotate the channel knob will select the two closed ship. The ships' list will be sorted according to their distance.

--Plotter Mode:

In LIST mode, long pressing the 'CH' button to enter the Plotter mode.

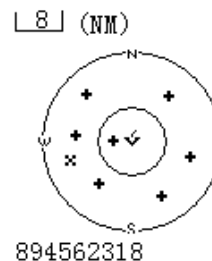

It will display the nearby ship on the screen.

Pressing SCAN and WATCH button will zoom in and out (1nm/2nm/4nm/16nm/32nm).

Rotate the CH knob will change the highlighted ship.

--Info. Mode

```

MMSI:412701450      MMSI:412701450
IMO:                 IMO:
MIN CHANG XING      MIN CHANG XING
SHIP                 SHIP
DISTANCE:5.5nM      DISTANCE:5.5nM
BEAR:183'           CAL SIGN:BAVT7
HEADING: 34.6'      WITHD: 1.4M
ROT: -725.6'/MIN    LENGTH: 10.0M
SOG:3.5KTS          DRAUGHT:----
COG:262.8'          TYPE-TANKER:
 113' 51' 6379E     RES- ERVE FOR
 22' 30' 4178N      FUTUR- US
NAV STATUS:UNDE-
R WAY USING ENG-
INE
    
```

It will display the selected ship information such as COG, SOG, etc.

All other button's press will result in an error beep

8. RT-650-M Wireless Microphone

option

The optional RT-650-M 2.4GHz wireless Microphone remotely controls the NAVICOM Marine radio and provides an optional intercom function, which is the next generation in wireless handheld microphones, compatible with new NAVICOM radios. It combines state-of-the-art technology with rugged durability and ease of use. The microphone's all solid-state design and conservatively-rated components and materials make it an ideal choice for harsh marine environments. The microphone's large display and backlit control buttons make it easy to use even in extreme lighting and weather conditions. You should read the rest of this Owners Manual thoroughly to acquaint yourself with all of your microphone's features and functions.

8.1 LOOK AT THE MICROPHONE

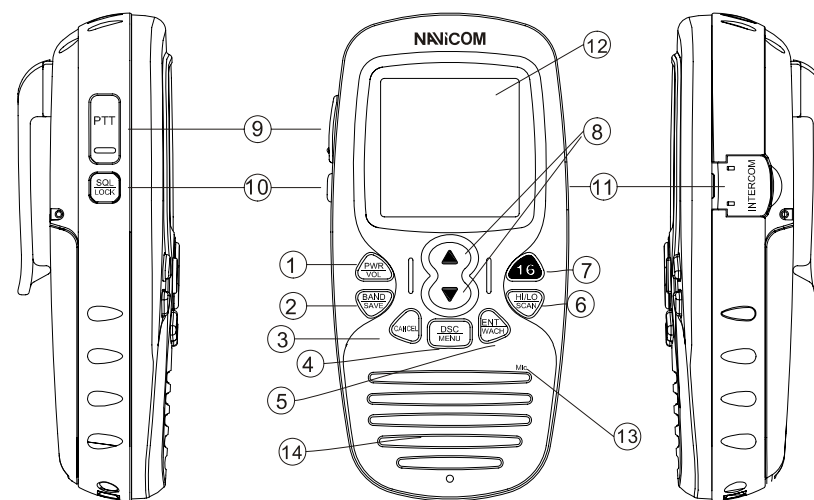

- ① VOL/ PWR Hold down for 2 seconds to turn on or off; Briefly press to select the volume setting mode.
- ② BAND / SAVE Press to select band (USA. Or INT). Hold down to set memory channels.
- ③ CANCEL Press to Cancel last selection or change without saving or step back one level on menu mode. Or cancels DSC Distress calls & auto-retransmission of DISTRESS calls.
- ④ DSC / MENU DSC calls Menu / Radio Setup Menu
- ⑤ ENT / WATCH Enter Values / Start or Stop Dual or Tri Watch Press and hold the button to start Dual-watch; During watch mode, press the button to switch between Dual and Tri-watch; Press and hold the button again to escape from watch mode.

- ⑥ HI/LO / SCAN Toggle between 25W and 1W output / Hold the button to start SCAN mode; During scan press the button to switch between PSCAN and SCAN mode; Hold the button again to escape from Scan mode.

- ⑦ 16 Access to priority channel quickly.

- ⑧ CH UP / DOWN Increase or decrease channel number, rolling the menu.

- ⑨ PTT Press to Transmit.

- ⑩ SQL / LOCK Press to turn on the squelch setting mode. Hold down to Lock/Unlock the button board.

- 11 INTERCOM Select to Internal communication mode

- 12 LCD Display screen

- 13 MIC Receive your voice

- 14 SPEAKER

8.2 A LOOK AT THE DISPLAY OF WIRELESS HANDSET

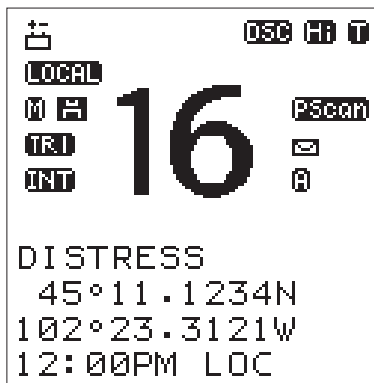

The screen is similar to the LCD of fixed radio, except the following SQL and VOL indicator:

Volume INDICATOR

Appears while audio output level is adjusted

SQUELCH INDICATOR

Appears while noise squelch level is adjusted

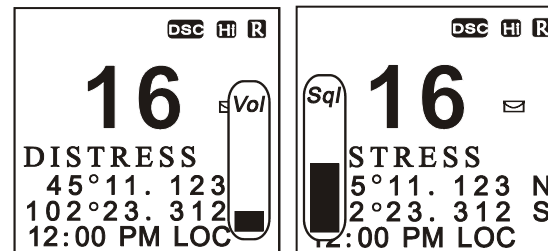

8.3 SETTING UP YOUR MICROPHONE

8.3.1 INSTALLING THE BATTERY PACK

1. Use a coin or screw driver to loosen the screw on the cover, open the cover of battery compartment.
2. Connect the battery pack connector observing the correct polarity (black and red wires) to the jack inside the battery compartment. Do not exert any force on this connection. It could cause damage to the battery or handset.

The plastic connector will fit together only one way. Once you are certain that you have made a good connection, then insert the battery pack into the battery compartment. Do not pinch the wires.

3. Tighten the screw on the cover.

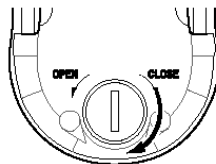
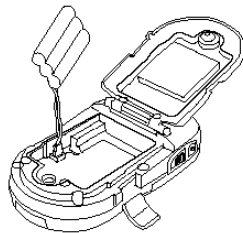
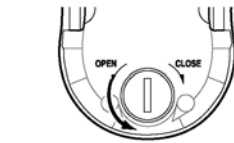

8.3.2 CHARGING THE BATTERIES

Before you use rechargeable batteries, you must charge them.

The microphone has a built-in circuit that lets you recharge batteries inside of the microphone. To charge the batteries, install the batteries in the microphone then slide it into the supplied cradle.

WARNING!

Before you use rechargeable batteries for the first time, charge them for 14 hours to bring them to a full charge. Discharged batteries take about 14 hours to fully recharge.

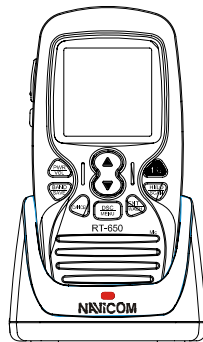

Caution: To ensure proper charging and avoid accidental release, always **FIRMLY** lock the handset into the charger.

8.3.3 INSTALLING THE BELT-CLIP

1. Place the belt-clip on the mounting area on the back of the Handset, making sure the hole in the clip lines up with the notch on the back of the Handset.
2. Insert the screw into the corresponding hole and tighten.

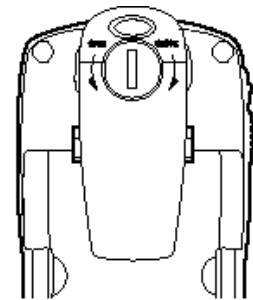

8.3.4 MOUNTING THE CRADLE CHARGER

1. Mount the drop-in charger to either a bulk head or dash.
 2. Plug one end of the AC adapter into a wall outlet, or the DC adapter into a cigarette lighter socket, and the other end into the drop-in charger.
- * Please turn the power Off on the handset before charging.

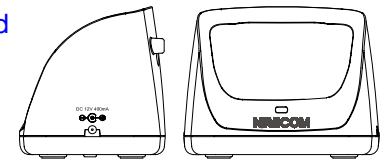

8.4 BASIC OPERATION

8.4.1 LINK THE WIRELESS MICROPHONE TO THE MAIN RADIO

The optional RT-650-M Remote-control wireless Handset Microphone can be connected to the transceiver directly, without limits of wires, you can use it to control and communicate the radio from almost anywhere aboard your vessel.

Before your first use the remote-control wireless microphone, the microphone must be subscribed as optional accessory to the NAVICOM marine radio.

The following details the subscription between the radio and microphone

1) Remote-control microphone:

Turn on the unit by hold down the PWR button more than 2 seconds, until the LCD appears "Power On", then immediately press "HILO/SCAN" button, LCD

appears "SUBSCRIBING", indicating the microphone waiting for response from radio

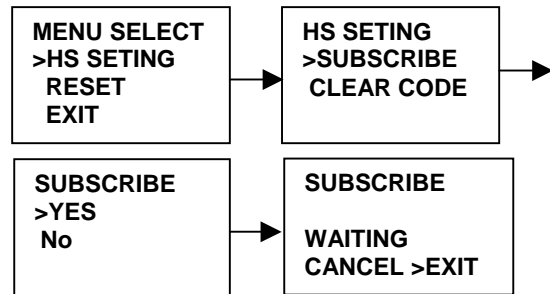

2) Fixed mount Marine Radio

Select the HS SETING from the MENU list and press CH knob. Then select SUBSCRIBING to start response to microphone

After successful subscription, the microphone will sound "Beep", and then LCD appears the normal screen, indicating the microphone had been linked to the radio

Notes: When the subscribe is not successful, or you want to subscribe another handset, it is recommended to clear exist code firstly:



8.4.2 TRANSMISSION AND RECEPTION

1. Turn on handset by pressing PWR/VOL button , (The wireless handset will automatically link to the radio if it had been successful subscribed to the radio before).
2. Press "CH UP/DOWN" to change channel, channel number on LCD both of Handset and Base will be updated simultaneity.
3. Squelch can also be adjusted on handset: Press "SQL/LOCK", LCD will appears the squelch

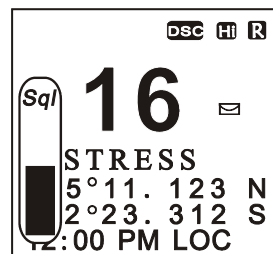

level dialogue as the figure shows, press "CH UP/DOWN" to increase or decrease Squelch level.

NOTE: Squelch level could be set both by SQL knob on base and wireless handset.

4. Press hi/LO / SCAN to toggle High and Low power output.
5. Press "PWR/VOL" to increase/decrease handset volume to comfortable level as the figure shows.
6. Press PTT button on the wireless handset to start transmission. The indicator on LCD is displayed.

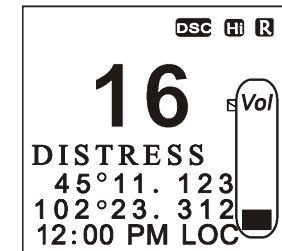

Speak clearly in a normal voice into the microphone on the wireless handset. Once the transmission is finished, release the PTT button. The radio will return into receive mode. Icon appear on screen.

8.4.3. BAND SWITCH

8.4.3.1 USA AND INT MODE

- 1) Press the **BAND/SAVE** button, to switch the operational channel band (USA & INT).
- 2) The icon will be displayed on the LCD for USA mode, the icon will be displayed on the LCD for INTL mode, Briefly press the button to toggles between USA and INT band.

8.4.3.2 SAVE MEMORY (FAV) CHANNELS

You can store all band channels but WX band as favorite channel. Program the FAV channel and store Process as follow:

- 1) At normal mode, tune to the desired channel and then press and hold the **BAND/SAVE** button to save it as Favorite channel. The icon will be turned on for indication that channel be saved in FAV list.
- 2) Then tune to next desired channel and repeat the button operation till all desired channels be programmed / saved.
- 3) Delete the channel from the FAV list at Normal mode. Select the specified channel with icon ON. Press and hold the **BAND/SAVE** button till the icon turn OFF. The specified channel will then be deleted out from the FAV list. Repeat the button operation for those unwanted channels.
- 4) If no channel has been programmed, an error beep occurs with indicate error message.

8.4.4. SCAN

Scanning is an efficient way to locate signals quickly over a wide frequency range.

The transceiver has 4 Scan modes available: All scan, FAV CH scan, Priority scan, and Priority FAV CH scan.

- 1) Press and hold the **BAND/SCAN** button to default all scan (1.2.3.4...).
- 2) Press **BAND/SCAN** Button to toggle between Scan and Pscan mode, icon on LCD will appear respectively
- 3) Hold the BAND/SCAN over 3 seconds again will escape from scan mode. It also can be to cancel by 16 or PTT.
- 4) FAV CH SCAN: If there are favorite channels stored, the scan (including all SCAN and PSCAN will be scanned only between these favorite channels)

8.4.5 WATCH

8.4.5.1 DUAL WATCH

Press and hold **ENT/Watch** button to activate the DUAL WATCH mode. Monitor the current channel and Ch 16 in cycle. Icon **DW** will appear on the LCD. Weather Alert is also activated automatically.

8.4.5.2 TRI-WATCH

Press ENT/Watch button to toggle the TRI WATCH mode. Monitor the current channel, CH 16 and CH 9 in cycle. Icon **TRI** will be turn ON

To quit the mode, press and hold **ENT/WATCH** button again, or press **16**, CANCEL button,

8.4.6 POSITION INDICATION

Your Hanset can display the position of the vessel's (longitude and latitude) as well as time information, if fixed radio connected to a GPS receiver. If no GPS equipment to be connected, an alert tone of 10 sec duration witch can be cancelled by any button will sound at 4 hour intervals to encourage manual input of positional data . Once no manual GPS input is made for 23.5 hours, "No GPS Information" will disappear from the screen. The position data transmitted goes to 9's and all the time data goes to 8's.

DISTRESS 23°20.1234 N 100°15.1002 E 08:10PM LOC
--

8.4.7 INTERCOM (Internal Communication)

The intercom feature lets you call and communicate with wireless handset connected to the radio

Please reference to previous description on section 4.8

8.5 SETTING MENU

SET-UP MENU NAVIGATION

- 1) To access the Menu Mode:

Press and hold **MENU/DSC** button, Text area displays the Set-Up Menu list.

- 2) To exit the Menu mode or sub –mode:

Press the 16 or CANCEL button or else select the EXIT option from the menu.

- 3) Press the **CH UP/DOWN** knob to scoll the Item within the Set-Up Menu list To confirm a selected item for adjustment, push the **ENT/WATCH** knob.

When the desired setting is done, press the **ENT/WATCH** knob to enter the setting, and move back to the Main Menu list.

- 4) Set Up operation is exited by turning the unit off. All changes are saved in EEPROM.

The following options are available through MENU:

NOTE: Most setup is the same as fixed radio described before, please refer to the corresponding sections.

BUDDY LIST		<i>Maintain your buddy list Ref. to section 6.3</i>
BACKLIGHT		<i>Set Handset's screen backlight level On/Off Only ON/Off selection, no level adjust</i>
CONTRAST		<i>Set Handset's screen contrast level Similar to section 6.5</i>
LOCAL/DIST		<i>Set radio sensitivity Ref to section 6.6</i>
GPS/TIME		<i>Set position & time manually, Set local time and time format Ref. to section 6.7</i>
RADIO SETUP		<i>Radio Setup Menu Ref. to section 6.8</i>
DSC SETUP		<i>DSC Setup Menu Ref. to section 6.9</i>
RESET		<i>Reset factory setting Ref. to section 6.12</i>

8.6 DSC CALL MENU AND SENDING AND RECEIVING DSC CALLS

Briefly press DSC/MENU button to enter the DSC CALL Menu as below, the similar operation as the fixed radio before. Please refer to the previous Chapter 5.

LAST CALL	Recall last call no matter what type of call received at last.
NEW CALL	Make a new call, by inputting the MMSI or pick up from the list max 20
GROUP	Sends transmissions that are only received by radios that share a common group MMSI number, up to 3 group MMSI numbers can be stored and call.
ALL SHIPS	Make an Urgency, Safety or Distress call to all ships. A re-confirmation screen follows the priority selection of Urgency, Safety or Distress. Such call will be sent out when assistance need but the situation not is so serious enough for a Distress Call. Urgency call is made when assistance required but not life endanger while Safety call is for advisory alert.
CALL LOG	Allow a review of all stored Calls by number and time of call. An individual call type can be placed to the selected MMSI/NAME in the LOG. The LOG maintains all received call types except DISTRESS calls. The call at the end of the list is automatically erased. The earliest call stored at the end of the list. There is 20 calls could be stored.
DISTRESS LOG	Allow a review of all stored Distress calls by number and time of call. An individual call type can be placed to the selected MMSI / NAME in the LOG. The call at the end of the list is automatically erased. The earliest call stored at the end of the list. There is also 10 calls could be stored.
POS REQUEST	The option enables you to request GPS position information from any vessel for which an MMSI-number is known, such request can pick up from buddy list.
EXIT	quit the menu mode.

Notes: There is no DISTRESS button with red cover on wireless handset. You CAN'T send DISTRESS call via wireless handset.

9 MAINTENANCE

Your VHF Marine Radio RT-650 is a marine radio of water proof who can meet the requirement of JIS level 7, gives you a good reliability when using in marine circumstance.

The equipment is designed to be maintenance free. To keep your radio in good working condition:

- Never unscrew the equipment, either the base station or handset, For in such case, the water proof performance will be greatly damaged.
- If the radio becomes dirty and dusty, wipe it clean with a moisture cloth, but pay attention to never using such solvents as benzene or alcohol, for they may damage the radio surfaces.
- Once your equipment does not work properly, never allow an unqualified person to tamper with internal adjustments. Please contact the local dealer for help.

TROUBLE SHOOTING

Item	Symptom	Cause/Remedy
1	Unit can not be powered on.	<ul style="list-style-type: none"> ● Check the connection to the base station. ● Check the volume control.
2	No sound comes from the speaker	<ul style="list-style-type: none"> ● Set [VOL] to a suitable level. ● Set squelch to the threshold point.
3	Transmitting is impossible, or high power can not be selected.	<ul style="list-style-type: none"> ● Check to see if the PTT switch is defective. ● Check to see if the microphone or MIC jack is defective. ● Some channels are for low power or receive only, change to another channel. ● Push H/L to select high power.
4	Low receiver sensitivity.	<ul style="list-style-type: none"> ● Check to see if the antenna being bad connected. ● Check the connection between coaxial cable and base station.
5	Wireless Handset no response	<ul style="list-style-type: none"> ● Re-subscribe between Fixed radio and Handset
6	Battery symbol is displayed	<ul style="list-style-type: none"> ● Check the battery voltage, which should be at least 10.5+/- 0.5V DC ● Check the alternator on the vessel
7	No position information is displayed	<ul style="list-style-type: none"> ● Check the GPS cable is physically connected ● Check the polarity of the GPS cable ● Check the baud rate setting of the GPS is applicable. The baud rate setting should be 4800 and parity should be set to NONE

10 SPECIFICATION

---VHF Radio

TX Frequency	156.050 ~ 157.425	MHz
RX Frequency	156.025 ~162.025	MHz
Channels	.55	USA hannels
	55	INT Channels
Modulation type	FM	
Antenna impedance	.50	Ohm
Microphone		Condenser type
Power supply	13.8	V DC
Sensitivity at 12dB SINAD	0.5	μV
Adjacent Channel Rejection.	70	dB
Audio output power	2W	@ 8 Ohm
Audio Distortion	10	%
RF Output Power.	High: 25W/Low: 1W	
Harmonic Emissions	High: 80dB/Low: 60dB	

--AIS Receiver

Frequency Range	161.975 and 162.025	MHz
Number of Channels	2	
Local Oscillator mode	PLL	
Sensitivity <20% BER	2	uV
Spurious Resp. Rej.	70	dB
Adjacent Channel selectivity	70	dB
Intermodulation Response	68	dB

--2.4GHz wireless RF link

Frequency Range	2401.056~2482.272	MHz
Number of Channels	95	
Sensitivity @ < 10 ⁻³ BER	-92	dBm

--Mechanism

Fixed unit Dimensions (HWT)	71x161x147	mm
Fixed unit Weight	1290	g

11. CHANNEL LIST

CH	NAME	INT (DSC ON)				CH	NAME	INT (DSC ON)			
		FREQUENCY (MHz)						FREQUENCY (MHz)			
		TX	RX	MODE	REMARK			TX	RX	MODE	REMARK
1	TELEPHONE	156.050	160.650	D		60	TELEPHONE	156.025	160.625	D	
2	TELEPHONE	156.100	160.700	D		61	PORT OPS	156.075	160.675	D	
3	TELEPHONE	156.150	160.750	D		62	PORT OPS	156.125	160.725	D	
4	PORT OPS	156.200	160.800	D		63	PORT OPS	156.175	160.775	D	
5	PORT OPS/VTS	156.250	160.850	D		64	TELEPHONE	156.225	160.825	D	
6	SAFETY	156.300	156.300	S	1W ATIS	65	PORT OPS	156.275	160.875	D	
7	PORT OPS	156.350	160.950	D		66	PORT OPS	156.325	160.925	D	
8	COMMERCIAL	156.400	156.400	S	1W ATIS	67	BRIDGE COM	156.375	156.375	S	
9	CALLING	156.450	156.450	S		68	SHIP-SHIP	156.425	156.425	S	
10	COMMERCIAL	156.500	156.500	S	1W ATIS	69	PORT OPS	156.475	156.475	S	
11	VTS	156.550	156.550	S	1W ATIS	70	DSC	156.525	156.525	S	
12	PORT OPS/VTS	156.600	156.600	S	1W ATIS	71	PORT OPS	156.575	156.575	S	1W ATIS
13	BRIDGE COM	156.650	156.650	S	1W ATIS	72	SHIP-SHIP	156.625	156.625	S	1W ATIS
14	PORT OPS/VTS	156.700	156.700	S	1W ATIS	73	PORT OPS	156.675	156.675	S	
15	PORT OPS	156.750	156.750	S	1W	74	PORT OPS	156.725	156.725	S	1W ATIS
16	DISTRESS	156.800	156.800	S		75	PORT OPS	156.775	156.775	S	1W
17	SAR	156.850	156.850	S	1W	76	PORT OPS	156.825	156.825	S	1W
18	PORT OPS	156.900	161.500	D		77	SHIP-SHIP	156.875	156.875	S	1W ATIS
19	SHIP-SHORE	156.950	161.550	D		78	SHIP-SHORE	156.925	161.525	D	
20	PORT OPS	157.000	161.600	D		79	SHIP-SHORE	156.975	161.575	D	
21	PORT OPS	157.050	161.650	D		80	SHIP-SHORE	157.025	161.625	D	
22	PORT OPS	157.100	161.700	D		81	PORT OPS	157.075	161.675	D	
23	TELEPHONE	157.150	161.750	D		82	PORT OPS	157.125	161.725	D	
24	TELEPHONE	157.200	161.800	D		83	TELEPHONE	157.175	161.775	D	
25	TELEPHONE	157.250	161.850	D		84	TELEPHONE	157.225	161.825	D	
26	TELEPHONE	157.300	161.900	D		85	TELEPHONE	157.275	161.875	D	
27	TELEPHONE	157.350	161.950	D		86	TELEPHONE	157.325	161.925	D	
28	TELEPHONE	157.400	162.000	D		87	TELEPHONE	157.375	157.375	S	
						88	TELEPHONE	157.425	157.425	S	

CH	NAME	USA				CH	NAME	USA			
		FREQUENCY (MHz)						FREQUENCY (MHz)			
		TX	RX	MODE	REMARK			TX	RX	MODE	REMARK
01A	PORT OPS/VTS	156.050	156.050	S		61A	UNAUTHORIZED	156.075	156.075	S	
03A	UNAUTHORIZED	156.150	156.150	S		63A	PORT OPS/VTS	156.175	156.175	S	
05A	PORT OPS/VTS	156.250	156.250	S		64A	UNAUTHORIZED	156.225	156.225	S	
6	SAFETY	156.300	156.300	S		65A	PORT OPS	156.275	156.275	S	
07A	COMMERCIAL	156.350	156.350	S		66A	PORT OPS	156.325	156.325	S	
8	COMMERCIAL	156.400	156.400	S		67	BRIDGE COM	156.375	156.375	S	1W PTT HI
9	CALLING	156.450	156.450	S		68	SHIP-SHIP	156.425	156.425	S	
10	COMMERCIAL	156.500	156.500	S		69	PLEASURE	156.475	156.475	S	
11	VTS	156.550	156.550	S		70	DSC	156.525	156.525	S	
12	PORT OPS/VTS	156.600	156.600	S		71	PLEASURE	156.575	156.575	S	
13	BRIDGE COM	156.650	156.650	S	1W PTT HI	72	SHIP-SHIP	156.625	156.625	S	
14	PORT OPS/VTS	156.700	156.700	S		73	PORT OPS	156.675	156.675	S	
15	ENVIROMENTAL	-	156.750		Rx Only	74	PORT OPS	156.725	156.725	S	
16	DISTRESS	156.800	156.800	S		77	PORT OPS	156.875	156.875	S	1W
17	SAR	156.850	156.850	S	1W	78A	SHIP-SHIP	156.925	156.925	S	
18A	COMMERCIAL	156.900	156.900	S		79A	COMMERCIAL	156.975	156.975	S	
19A	COMMERCIAL	156.950	156.950	S		80A	COMMERCIAL	157.025	157.025	S	
20	PORT OPS	157.000	161.600	D		81A	UNAUTHORIZED	157.075	157.075	S	
20A	PORT OPS	157.000	157.000	S		82A	UNAUTHORIZED	157.125	157.125	S	
21A	UNAUTHORIZED	157.050	157.050	S		83A	UNAUTHORIZED	157.175	157.175	S	
22A	COAST GUARD	157.100	157.100	S		84	TELEPHONE	157.225	161.825	D	
23A	UNAUTHORIZED	157.150	157.150	S		84A	TELEPHONE	157.225	157.225	S	
24	TELEPHONE	157.200	161.800	D		85	TELEPHONE	157.275	161.875	D	
25	TELEPHONE	157.250	161.850	D		85A	TELEPHONE	157.275	157.275	S	
26	TELEPHONE	157.300	161.900	D		86	TELEPHONE	157.325	161.925	D	
27	TELEPHONE	157.350	161.950	D		86A	TELEPHONE	157.325	157.325	S	
28	TELEPHONE	157.400	162.000	D		87	TELEPHONE	157.375	161.975	D	
						87A	TELEPHONE	157.375	157.375	S	
						88	TELEPHONE	157.425	162.025	D	
						88A	COMMERCIAL	157.425	157.425	S	

CH	NAME	USA / EUR				CH	NAME	USA / EUR			
		FREQUENCY (MHz)						FREQUENCY (MHz)			
		TX	RX	MODE	REMARK			TX	RX	MODE	REMARK
2.4G Module											
0		2401.0560	2401.0560			25		2444.2560	2444.2560		
1		2402.7840	2402.7840			26		2445.9840	2445.9840		
2		2404.5120	2404.5120			27		2447.7120	2447.7120		
3		2406.2400	2406.2400			28		2449.4400	2449.4400		
4		2407.9680	2407.9680			29		2451.1680	2451.1680		
5		2409.6960	2409.6960			30		2452.8960	2452.8960		
6		2411.4240	2411.4240			31		2454.6240	2454.6240		
7		2413.1520	2413.1520			32		2456.3520	2456.3520		
8		2414.8800	2414.8800			33		2458.0800	2458.0800		
9		2416.6080	2416.6080			34		2459.8080	2459.8080		
10		2418.3360	2418.3360			35		2461.5360	2461.5360		
11		2420.0640	2420.0640			36		2463.2640	2463.2640		
12		2421.7920	2421.7920			37		2464.9920	2464.9920		
13		2423.5200	2423.5200			38		2466.7200	2466.7200		
14		2425.2480	2425.2480			39		2468.4480	2468.4480		
15		2426.9760	2426.9760			40		2470.1760	2470.1760		
16		2428.7040	2428.7040			41		2471.9040	2471.9040		
17		2430.4320	2430.4320			42		2473.6320	2473.6320		
18		2432.1600	2432.1600			43		2475.3600	2475.3600		
19		2433.8880	2433.8880			44		2477.0880	2477.0880		
20		2435.6160	2435.6160			45		2478.8160	2478.8160		
21		2437.3440	2437.3440			46		2480.5440	2480.5440		
22		2439.0720	2439.0720			47		2482.2720	2482.2720		
23		2440.8000	2440.8000								
24		2442.5280	2442.5280								

CE certificate

CE certificate