

1	ABOVE ALL... SAFETY!	3
1.1	Symbols used.....	3
1.2	Warnings.....	3
	1.2.a General.....	3
	1.2.b Radiofrequency/installation.....	3
	1.2.c Automatic Transmitter Identification System (ATIS).....	3
	1.2.d Environmental.....	4
1.3	ETSI Information.....	4
1.4	Registration of your Marine Transceiver.....	4
1.5	Assistance.....	4
1.6	Manual Notes.....	4
2	INTRODUCTION	5
2.1	Generalities.....	5
3	DESCRIPTION OF CONTROLS AND CONNECTORS	6
3.1	Front panel.....	6
3.2	Back panel (connections).....	7
3.3	Microphone.....	8
4	INSTALLATION	9
4.1	Contents of package.....	9
4.2	Location for the transceiver.....	10
4.3	Mounting of transceiver.....	10
4.4	Adjustment of angle.....	11
4.5	Installation of the antenna/electromagnetic exposure.....	11
4.6	Mounting of Microphone.....	12
4.7	Connections.....	12
	4.7.a Power Supply.....	13
	4.7.b GPS device.....	13
	4.7.c Antenna.....	13
5	BASIC OPERATION	13
5.1	Turning NEPTUNE on/off.....	13
5.2	Volume regulation.....	13
5.3	Squelch Regulation.....	13
5.4	Selecting an operating channel.....	14
	5.4.a With alphanumerical keypad.....	14
	5.4.b Using the microphone buttons (UP or DOWN).....	14
5.5	Transmission and reception.....	14
5.6	Selecting high and low transmission power.....	14
5.7	Instant recall of channel 16.....	15
5.8	Display lighting.....	15
6	SCANNING FUNCTIONS	16
6.1	Channel scanning.....	16
6.2	Dual Watch and Triple Watch.....	16
6.3	Activation of Dual Watch/Triple.....	17
6.4	Memory channels (MEM mode).....	18
	6.4.a Memory scanning (SCAN MEMORY).....	18
	6.4.b Reception/Transmission during SCAN MEMORY.....	18
	6.4.c To delete/To jump a pre-selected channel in memory.....	18

7	USE WITH GPS	19
7.1	Function.....	19
7.2	GPS information on the display.....	19
8	DIGITAL SELECTIVE CALLING (DSC)	19
8.1	Introduction	19
8.2	Mobile Marine Identification Service (MMSI).....	19
8.3	Navigating the DSC menu.....	20
8.4	Individual call (ROUTINE TO).....	20
	8.4.a <i>Sending an individual call</i>	20
8.5	Group calling (Group Call)	21
	8.5.a <i>Sending a group call</i>	21
8.6	General call to all ships (ALL SHIP SAFETY – ALL SHIP URGENCY).....	21
	8.6.a <i>Sending a call to all ships</i>	21
8.7.	DSC DISTRESS call.....	22
	8.7.a <i>Sending a DISTRESS call</i>	22
9	RECEIVING A DSC CALL	23
	9.1.a <i>Receiving a distress call</i>	23
	9.1.b <i>General call to all ships</i>	23
	9.1.c <i>Individual call</i>	23
10	CUSTOMIZATION	24
10.1	Menu settings.....	24
10.2	Navigation in the menu of settings.....	24
10.3	List of settings	24
10.4	“Log” (list of registered calls).....	24
10.5	“Dir” (Entries in the directory)	25
	10.5.a <i>Addition of addresses</i>	25
	10.5.b <i>To modify/cancel addresses</i>	25
10.6	“Posn”(Setting of position coordinates and adjustment of UTC time).....	25
10.7	“LCD” (display contrast).....	26
10.8	“Beep” (Enable/disable keypad beep).....	26
10.9	“ZONE”(Adjustment of UTC time deviation).....	26
10.10	MMSI (Setting of personal MMSI code and MMSI group code)	27
10.11	“ATIS” (Setting of ATIS code and activation – deactivation of automatical transmission)	27
10.12	GPS receiver setting.....	28
11	PROGRAMMING AND SELECTION OF PRIVATE CHANNELS	29
12	MAINTENANCE	29
12.1	Maintenance and warnings	29
13	TROUBLESHOOTING	30
14	TECHNICAL SPECIFICATIONS:	31
14.1	Transmitter.....	31
14.2	Receiver.....	31
15	FREQUENCY TABLE	32

1 ABOVE ALL... SAFETY!

1.1 Symbols used

For ease and convenience of viewing, NEPTUNE uses symbols to highlight urgent situations, practical advice, and general information.

- ☞ **Warnings such as this, shown using an open hand symbol, indicate a crucial description regarding technical repairs, dangerous conditions, safety warnings, advice and/or important information. Ignoring these symbols may result in serious problems and/or damage and/or personal injury.**
- 📄 *Notes such as this one indicate practical advice that we suggest be followed for optimal performance with NEPTUNE.*

1.2 Warnings

1.2.a General

- ☞ **This device has been tested for compliance with Class D digital marine device limits. These limits were created to allow for reasonable protection against damaging interference.**
- ☞ **This device is to be used solely as an aid to navigation. Its settings may be influenced by diverse factors, such as defects or malfunction of the device, environmental conditions or improper use.**
- ☞ **It is the user's responsibility to observe reasonable prudence and judgement in navigation, and as such this device should not be considered a substitute for this reasonable prudence and judgement.**
- ☞ **Do not open the radio for any reason! NEPTUNE's precision mechanics and electronics require expertise and specialized equipment; for the same reason, the radio should under no circumstances be realigned as it has already been calibrated for maximum performance. Unauthorized opening of the transceiver will nullify the warranty.**

1.2.b Radiofrequency/installation

- ☞ **Midland recommends following the requirements for prevention of radiofrequency exposure. Unauthorized changes or modifications to this device may invalidate conformity to the ETSI Regulations. All changes or modifications must be approved in writing by MIDLAND Corp.**
- ☞ **This VHF DSC transceiver generates and irradiates electromagnetic energy (EME) at radiofrequency (RF), and as such must be installed and placed in operating conditions that are in conformity with the instructions contained in this manual and with current regulations. Not following these instructions can cause personal injury and/or malfunction of the device.**
- ☞ **Do not use NEPTUNE before connecting a suitable antenna that is in perfect working condition – although NEPTUNE is protected, this may seriously damage the stages of transmission power.**
- ☞ **Do not use transmit before ensuring proper connection of the antenna. During transmission, remain at a minimum distance of 1mt from the antenna.**

1.2.c Automatic Transmitter Identification System (ATIS)

- ☞ **Your marine transceiver may activate, if necessary, the ATIS function. The ATIS function may be activated when using the transceiver within the internal navigable waters of Europe which require the automatic transmission of identification. For further details, please contact your local authorities.**

1.2.d Environmental

- ☞ Pay attention to ambient conditions – although NEPTUNE is designed to operate under the most severe conditions, it is important to avoid exposure to environments that are excessively humid or dusty, or to temperatures outside the -15 to $+55^{\circ}\text{C}$ range. Also avoid exposure to direct sunlight.
- ☞ Avoid jarring and excessive vibration – NEPTUNE is built to resist mechanical shock and vibration as long as these are within the norm for any electrical device.
- ☞ Do not use this device in potentially explosive environments. A single spark may cause an explosion.

1.3 ETSI Information

ETSI (European Telecommunications Standards Institute) has established specific requirements (EN 301 025-1/2/3) for marine transceivers with DSC function class "D". For use on non-SOLAS vessels.

1.4 Registration of your Marine Transceiver

For using GMDSS and DSC functions, the operator must have a GMDSS radio operator's certificate (SRC or LRC) and apply for a ship's MMSI number at the local radio authority. Without MMSI number the radio can only be used as conventional VHF marine radio without DSC. For seagoing ships, entering the European inland waterways you can apply for an **additional** licence and can obtain an ATIS number for the ship's radio station. For ships, operating only on inland waterways, a ship's licence can be obtained for ATIS mode only. Switching to ATIS mode is requested on all European inland waterways. In ATIS mode, automatically some restrictions of transmit power apply on certain channels, and some functions like Dual and Triple Watch are not available. Your distributor may program your radio according to your needs.

1.5 Assistance

We urge you to write the serial number of your transceiver in the space provided below. This number is found on the back panel of the transceiver and will be useful in the event of repair/assistance and/or loss and/or theft.

Serial number _____

1.6 Manual Notes

Writing of this manual has been completed with the intention of supplying information that are comprehensive, precise and up-to-date. Nevertheless, the manufacturer does not assume responsibility for the actual correspondence with the product and for the consequences of possible errors caused by factors over which it has no control. Equipment and options described may differ according to varying countries.

E. and O.E.

All rights reserved.

2 INTRODUCTION

2.1 Generalities

Congratulations for choosing Midland's marine transceiver NEPTUNE. This product is a high performance, mobile VHF DSC marine transceiver. The following are its principle features:

- **Equipped with all international channels** available (correctly assigned).
 - **High transmission power of 25W**, which allows the user to maintain contact from large distances, and a low transmission power of 1 watt to reduce consumption during short-distance communication.
 - Switchable between **DSC System** (Class "D") and **ATIS** function for European inland waterways
 - **Principal commands duplicated on the microphone** for faster accessibility – channel selection and channel **16** recall.
 - **Backlit LCD display and adjustable contrast** – constantly shows NEPTUNE's parameters and settings and occurs a optimal visualization.
 - **Possibility to program 20 private channels and 16 MMSI numbers** by means of the optional programming kit "PGR NEPTUNE". We remind that the use of private channels is controlled by the national competent authorities: for this reason, we suggest you contact the local radio communication authorities. For the use in Germany a special licence is requested. Only authorized persons are allowed to use private channels when shipping on European inland waterways.
 - **Extraordinary capability for water resistance**, conforms with the standard IP54.
 - **Recall button for Channel 16** – for instant access to channel **16** (the universal marine channel for emergency contact).
 - **NMEA connection** – use the interface cable supplied for easy connection from transceiver to optional GPS system, such as GPS 200 or other compatible GPS. Once connected, the display will show the automatically updated coordinates (latitude and longitude) and time data.
 - **DSC Digital Selective Calling** – for security on the water and the ability to make quick calls automatically (the transceiver supports DSC (Digital Selective Calling) operations with a specifically designed DSC unit which conforms to the ITU-R standard, M493-10 Class D requirement).
 - **ATIS-Function** – Automatic Transmitter Identification System for European inland waterways
 - **MMSI directory**, which simplifies the sending of DSC calls to frequently called contacts and allows viewing of contact name on the display.
 - **Mounting on adjustable bracket** for stable and comfortable positioning in any condition.
 - **Connection to an external speaker** (optional) – for listening to communications further away from the transceiver.
- ⚠ *The manufacturers, in their effort to constantly improve product quality, reserve the right to change the above characteristics without forewarning. For eventual updates, visit www.cte.it or contact your authorized dealer.*
- ⚠ *NEPTUNE is switchable between DSC System (Classe "D") and ATIS-Function for European inland waterways and is **approved for both** systems.*
- ⚠ ***In ATIS mode, all Scan and Dual / Triple Watch functions are disabled, and on all ship-to-ship and ship-to harbor channels the transmit power will automatically be reduced to values between 0.5 and 1 Watt.***

3 DESCRIPTION OF CONTROLS AND CONNECTORS

3.1 Front panel

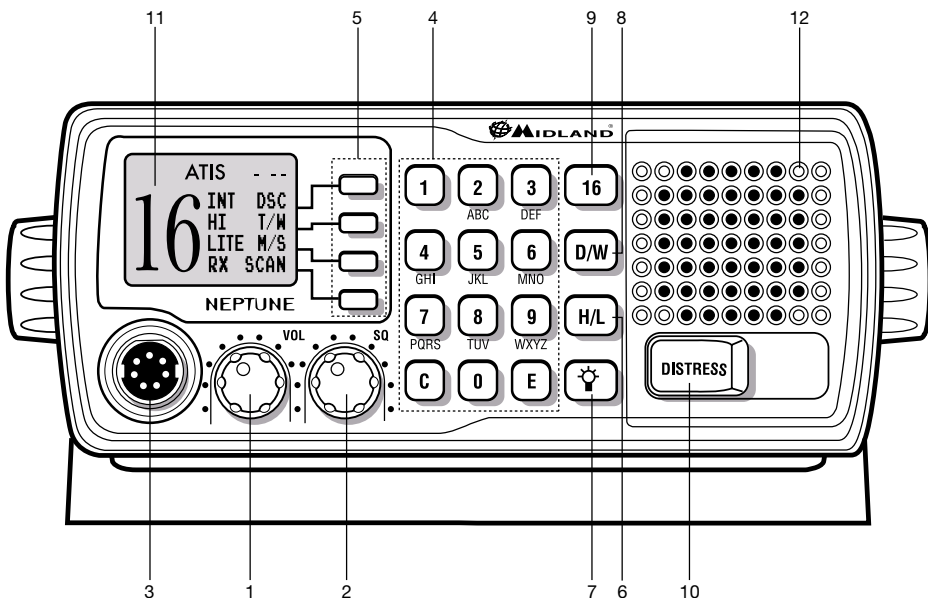

- (1) **OFF/VOLUME knob**
Turns NEPTUNE on/off and regulates audio volume reception. The radio is turned off when you completely rotate the knob counter-clockwise until it clicks.
- (2) **SQUELCH knob**
Regulates the squelch level (noise silencer in absence of signals).
- (3) **MICROPHONE socket**
Insert the mike connector into this socket.
- (4) **Alphanumeric keypad**
The keypad gives the possibility to select channels, to add your own MMSI identification code and to activate/deactivate many other functions described in the following pages.
- (5) **FUNCTION keys**
They enable to enter into the menu pages, to activate some functions such as Triple Watch, SCAN or to activate the ATIS mode.
- (6) **H/L button**
Push the **H/L** button to select high transmission power (25W) or low power (1W). The LCD display will show **HI** (high power) or **LO** (low power). The **H/L** function is accessible in normal VHF or MEM mode.
- (7) **☀ button**
Hold the ☀ button down to activate the display and keypad backlight ("LITE" appears on the display). You can select 4 different backlight levels.

- (8) **D/W button**
This button activates the Dual Watch function, able to search alternatively the tuned channel and channel **16**.
- (9) **Button 16**
Pressing the **16** button provides quick access to channel **16**.
- (10) **DISTRESS button**
The button below a soft cover sends a **DISTRESS** call for help. The signal also includes your MMSI identification code and the nature of the distress. If a GPS is connected to the device, data regarding position and time are also included in the call. For further details, see paragraph 8.7.
☞ *The Distress function, or any other DSC transmission function, is not operative until a MMSI user code has been inserted.*
- (11) **LCD Display**
The large LCD (liquid crystal) display constantly shows the operating status of the device as well as being a function guide thanks to its easily readable dot matrix area.
- (12) **Internal speaker**
Guarantees clear listening of communications.

3.2 Back panel (connections)

- ☞ **Warning! Faulty connections or short-circuits may seriously damage NEPTUNE. Before attempting any connections, consult the specialized sections of this manual.**

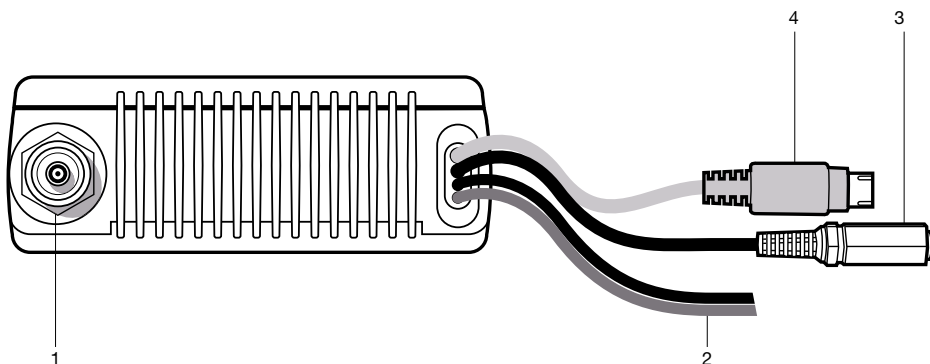

- (1) **Antenna socket**
This SO 239 socket is for connecting an appropriate antenna.
- (2) **Power cable**
This red/black cable has to be connected to a power source of 12 Vdc (red is positive). Attention: for 24 V power sources a converter is needed!
- (3) **Socket for additional external loudspeaker**
You can use this jack for the connection to a suitable external loudspeaker (optional), if needed.
- (4) **GPS connector**
Allows for connection to the optional receiver module "GPS200" cod. C723 (or other compatible receiver), for obtaining, viewing and transmitting (with DSC) information regarding position and current time data.

3.3 Microphone

- (1) **UP and DOWN buttons**
These two buttons change the tuning channel. The first scrolls upwards through the tuned marine channels, the second scrolls downwards.
- (2) **Button 16**
For ease of use, button **16** performs the same function as the button **16** on the front panel of the transceiver.
- (3) **PTT (push to talk)**
Pressing this button will begin transmission.
- (4) **Microphone**
During transmission, speak a few centimeters from the microphone.

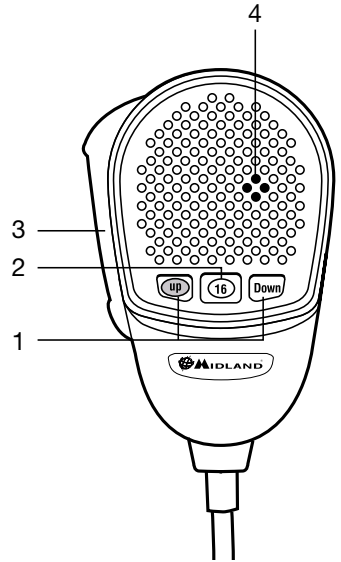

4 INSTALLATION

4.1 Contents of package

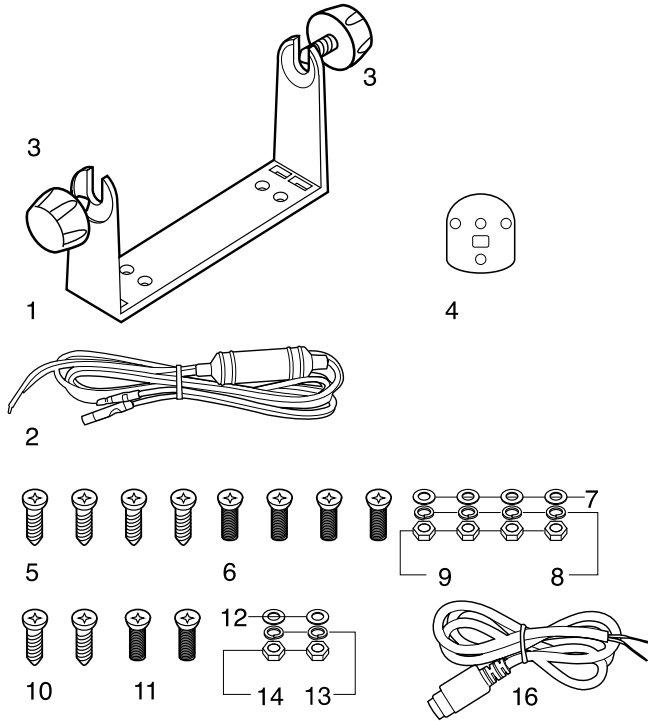

Before using your transceiver, ensure that your package is complete and contains:

- (1) Mounting bracket
- (2) DC power cord with integrated protecting fuse
- (3) Knobs (2 pieces)
- (4) Mounting piece for microphone
- (5) Self-threading screws for mounting bracket (4 pieces)
- (6) Screws for mounting bracket (4 pieces)
- (7) Washers (4 pieces)
- (8) Grained washers (4 pieces)
- (9) Nuts (4 pieces)
- (10) Self-threading screws for microphone mount (2 pieces)
- (11) Screws for the microphone mount (2 pieces)
- (12) Washers (2 pieces)
- (13) Grained washers (2 pieces)
- (14) Nuts (2 pieces)
- (15) Certificate of warranty and instruction manual (not shown)
- (16) Cable for GPS receiver

⚠ Depending on the model, some parts may already be attached/connected to the device. In any case, if any parts are missing, immediately contact your supplier.

4.2 Location for the transceiver

Before continuing, look for a place to install the transceiver which:

- Is far enough away from any device sensitive to magnetic/electromagnetic fields (e.g. compass) in order to avoid interference during their use.
- Allows for accessibility to the front panel of NEPTUNE.
- Provides easy connection to a power supply, for the antenna and for other cables.
- Has sufficient space close by for installation of the microphone support.
- Allows for mounting of the antenna at least 1 meter from the transceiver.

📄 *The universal mounting bracket supplied allows for mounting of the transceiver high up (with the bracket above the device) or on the bridge (with the bracket below the device) with an angle range of 45°.*

⚠️ **Warning! Installation and connections must be performed in part by qualified persons.**

4.3 Mounting of transceiver

To mount the transceiver to your vessel (see following picture):

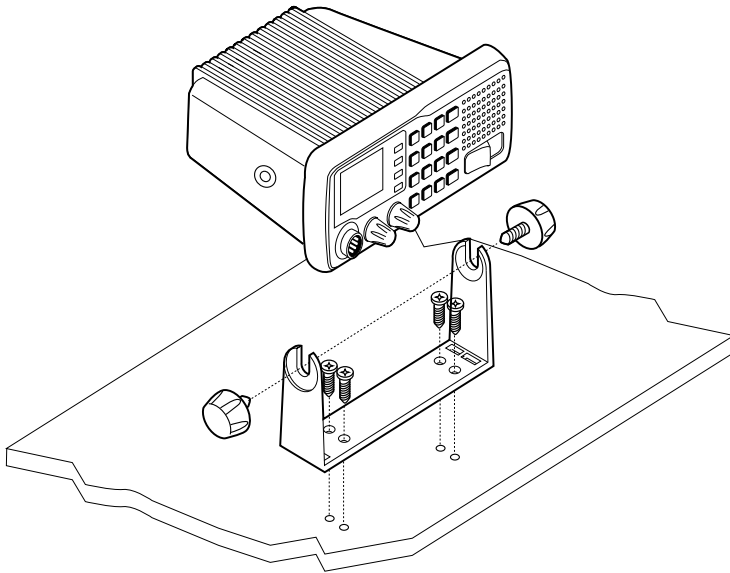

1. Choose an appropriate location, as explained in the paragraph above.
 2. Position the mounting bracket on the surface upon which it will be fixed, use a pencil to draw the position of the four holes where the screws will be inserted.
- ⚠️ **Ensure that the surface intended for the transceiver mounting can be drilled into without provoking damage to other parts of the vessel and be careful to not drill right through it.**
3. Remove the bracket, drill four holes smaller in diameter than the screws, and reposition the mounting bracket, aligning it with the four holes.
 4. Screw in the mounting screws and ensure the bracket is fixed firmly, using the screws, the grained washers, the flat washers and the nuts supplied.
- ⚠️ **If you are not able to reach the back part of the bracket surface to fix the nuts onto the screws, use threaded screws to fix the bracket.**

5. Tighten the screws with a screwdriver so that the bracket is firmly fixed to the surface.
 6. Align the transceiver on the bracket, ensuring the holes of the internal part of the bracket line up with those on both sides of the transceiver (you can choose the preferred notch in order to best adjust the angle of the transceiver's front panel for ease of viewing and use (15° of variation for each notch).
 7. Mount the mounting knobs on the two sides of the bracket to soundly fix the transceiver.
- ⚠ **Keep the transceiver and microphone at a distance of at least 1 meter from all other magnetic devices (e.g. compass) on your vessel.**

4.4 Adjustment of angle

To change the angle of inclination after installation:

1. Loosen the mounting knobs on the sides of the bracket.
2. Adjust the transceiver to a better angle, lining up the holes of the internal part of the bracket with those on both sides of the transceiver.
3. Tighten the knobs to fix the transceiver into place.

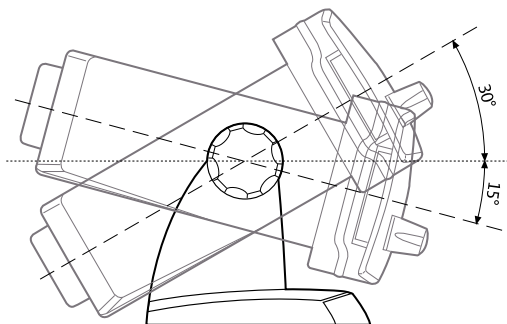

4.5 Installation of the antenna/electromagnetic exposure

For optimal radio settings and minimal user exposure to electromagnetic radiofrequency energy, ensure that:

- The antenna is connected to the transceiver and is properly installed.
- The antenna is situated away from people and is positioned at least one meter from the transceiver and microphone.
- The connector is a standard PL259 (male UHF).

4.6 Mounting of Microphone

To mount the microphone mount, look first for a mounting point close to the transceiver. The distance between the transceiver and the wall mount must be less than the length of the microphone cable.

Do not pull excessively on the microphone cord. This part is important to the correct function of the device: over time, pulling may damage the cord and impede the user from transmitting.

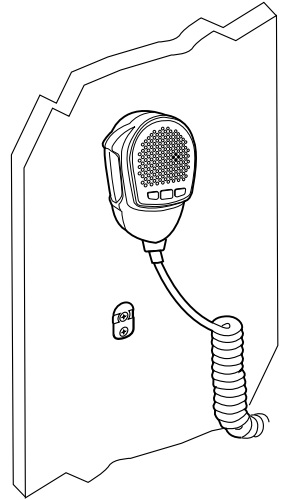

4.7 Connections

Refer to the following diagram:

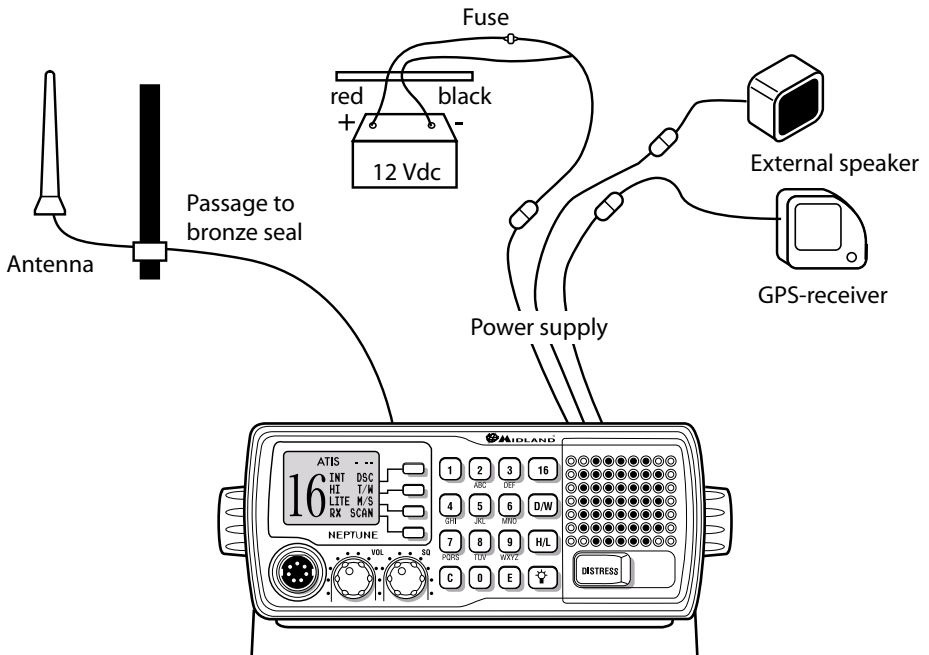

4.7.a Power Supply

The transceiver power supply must be 12Vdc (see specifics in par. 14). The red cable must be connected to the positive pin, the black to the negative pin.

🔊 **Warning! A faulty connection may seriously damage the radio!!**

🔊 **The power cable is equipped with a protection fuse. If the fuse shorts, look for its reason before substituting the cable with a new one of the same type and value. Never short-circuit it, as this may damage the radio.**

4.7.b GPS device

If your NEPTUNE transceiver is connected to a GPS receiver, such as the GPS 200, you can obtain and view NMEA information relative to the current position of the vessel (latitude and longitude) and the local time with respect to Greenwich Mean Time (GMT).

4.7.c Antenna

The antenna is an extremely important part of the device and noticeably influences the settings of any telecommunications device. Contact your supplier regarding the antenna and request advice about how to mount and best connect it to your transceiver.

🔊 **Warning! Ensure the antenna is in perfect working order. It may otherwise seriously damage the radio! A periodical measurement of the stationary waves is advised using a suitable SWR metre.**

5 BASIC OPERATION

5.1 Turning NEPTUNE on/off

To turn the transceiver on, rotate the **OFF/VOLUME** knob clockwise until it clicks on. You will hear a beep (acoustic signal) and the LCD display will come on: the device is turned on to VHF mode.

To turn the transceiver off, rotate the knob counter-clockwise until you hear further click: the LCD display will turn off.

📄 *If your transceiver is not connected to a GPS receiver, it is necessary to insert manually your coordinates, otherwise an alarm will continue to sound. For further details, see par.7.1.*

5.2 Volume regulation

Bring the **OFF/VOLUME** knob first to medium volume. Once the transceiver picks up a signal, adjust the volume to a comfortable level. If no signal is picked up, use the squelch control as described in the following paragraph and regulate the volume using background noise.

5.3 Squelch Regulation

Squelch is used to eliminate the annoying background noise you hear when no signal is being picked up. If the squelch is adjusted correctly, there should be silence in between calls as well as a reduction in battery consumption. To regulate squelch:

1. Rotate the **SQ** knob completely counter-clockwise until you hear background noise (if you don't hear anything, turn up the volume) and bring up **RX** on the LCD display.
2. If no signal is being received (only noise), slowly rotate the **SQ** knob clockwise, stopping as soon as the noise and **RX** disappear stably.

- ☞ If you regulate the squelch level too high (closed), you may hear only background noise or intermittent discharges. Correct setting of squelch is also important for reasons discussed further on.

5.4 Selecting an operating channel

5.4.a With alphanumerical keypad

1. Ensure that you are in normal operating mode (radio mode), otherwise press several times the button related to “**RAD**” or press the “**C**” button until the display shows: (A)
2. Select the desired channel and confirm by pressing the “**E**” button; the radio emits one beep.

☞ If there is no confirmation within 2 seconds by pressing the “**E**” button, NEPTUNE will return to the previously used channel.

☞ If a “notexisting” channel is inserted, for example CH99, the radio emits 4 warning beeps, after the **E** button has been pressed. If it is not pressed again for confirmation within 2 seconds, NEPTUNE will return to the channel previously used.

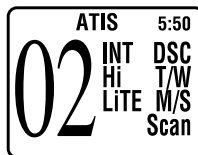

A

5.4.b Using the microphone buttons (UP or DOWN)

1. Ensure that you are in normal operating mode (Radio mode); otherwise follow the procedure described in par. 5.4.a.
 2. Press repeatedly the **UP** or **DOWN** buttons on the microphone to scroll through the marine channels until finding the desired channel.
- ☞ Holding down one of the buttons will allow you to scroll quickly through the channels.
- ☞ The marine band does not recognize some channel numbers. Refer to the frequency table. The channels may have different receiving and transmitting frequencies (duplex channels) or may have the same (simplex channels).
- ☞ Regulations require that some channels operate on low transmission power (see Chap.1). For this reason, NEPTUNE automatically switches to low frequency when these channels are selected.

5.5 Transmission and reception

☞ **Transmitting without a perfectly functioning antenna may seriously damage the transceiver.**

The **PTT** (Push-To-Talk) button is located on the external microphone of your NEPTUNE. To transmit:

1. Ensure that no one else is speaking.
2. Hold down the **PTT** button on the microphone. **TX** will appear on the Display.
3. Wait a second, then speak in a normal voice about 5 cm from the microphone.
4. When you have finished, release the **PTT** button: **TX** will disappear from the display.

Now NEPTUNE is in receiving mode (silent and waiting for a signal) where it will automatically receive any communication.

5.6 Selecting high and low transmission power

The transmission phase absorbs the most energy. To reduce the risk of wearing out the battery, we recommend selecting low transmission power when transmitting over short distances. Hold the **H/L** button down (on the radio): **Lo** (low power) appears on the display. When transmitting or receiving over long distances or with weak signals, press the **H/L** button again. **Lo** will be replaced with **Hi** (high power) on the display.

🔊 *When the transceiver is tuned to a channel limited to low output power, pressing the **H/L** button has no effect.*

5.7 Instant recall of channel 16

Channel **16** is a security and distress channel. This channel is used to establish initial contact with another station and for emergency communication. This channel can be called up at any time by pressing button **16** on both the transceiver. To return to normal operations, select another channel using the alphanumeric keypad or the **UP/DOWN** buttons on the microphone. By pressing a second time the **16** button, the radio returns to the previously used channel before selecting channel **16**.

🔊 **Do not transmit on channel 16 unless absolutely necessary. Doing so may impede emergency operations.**

5.8 Display lighting

If ambient lighting is insufficient for reading the display, the LCD display backlighting can be adjusted. Hold pressed the button  until a desired level is reached or until it has been completely turned off. If the backlighting is activated, the display shows "LITE". The chosen level of backlighting remains stored, also in case of extinction and successive turning on the radio.

If you desire to switch off the backlighting immediately or if you like to reactivate the previously inserted level, press the  button.

6 SCANNING FUNCTIONS

6.1 Channel scanning

NEPTUNE can automatically search for signals throughout the marine band by scanning, or selecting the channels in rapid sequence. When a signal is detected, the scanning pauses on that channel and remains blocked until the signal ends. Before the scanning automatically starts again, NEPTUNE waits for a few seconds in case the user wishes, if necessary, to respond to a call even if in truth you will see the channels being scanned.

The NEPTUNE scanning happens with a minimum of 2 channels to a maximum of 56 channels on the INT band (channel 70 is not selectable).

- In order to execute the scanning of the marine channels, it is necessary to create a list of channels for scanning. Operate in the following way:
 1. Select a channel you desire to insert into the scanning list.
 2. Hold pressed for 2 seconds the function key corresponding to the word “**SCAN**” (B); the radio beeps twice and on the display appears for a short moment the indication “**Scan Ena**” (C).
 3. If you desire to cancel a channel from the scanning list, repeat the procedure as described at point 2. In that case the display is showing “**Scan Inn**”.
 4. Once created your list, you can activate the scanning by pressing the function key corresponding to the word “**Scan**” (B).
- If you want to eliminate (useful if there are distortions) or to exclude momentarily (useful for undesired conversations) a channel during scanning, operate as follows:
- **DEFINITIVE EXCLUSION OF A CHANNEL:**

If your NEPTUNE is operating on a disturbed channel, press the function key corresponding to the word “**Inn**” (E).
- **MOMENTARILY EXCLUSION OF A CHANNEL:**

Press the function key corresponding to the indication “**Adv**” to advance the scanning and to eliminate definitively this channel from the scanning list. At the end of the complete scanning cycle, the channel previously jumped will be monitored again.
- *The scanning can be stopped by pressing the buttons C, or button 16 on the microphone or by sending out a **DISTRESS** call. Your transceiver will stop on the current channel (if you pressed button C) or on channel 16 (if you pressed 16 or PTT on the microphone).*

☞ *Note: Scanning does not function correctly if the squelch is not regulated as described in par.5.3.*

☞ *All scan modes are not enabled during ATIS mode (this is requested by authorities) on inland waterways.*



B



C

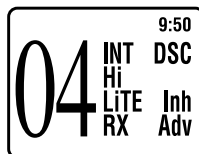

D

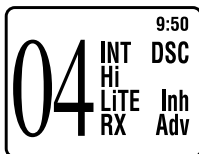

E

6.2 Dual Watch and Triple Watch

The meaning of these terms are:

- *Dual Watch* – allows the user to remain tuned to a channel of choice while periodically performing an automatic verification of signals on channel 16.
- *Triple Watch* – as written above, including a third channel chosen by the user.

6.3 Activation of Dual Watch/Triple

To activate Dual or Triple watch:

- *Dual watch* - Select a desired channel and press the **D/W**-button. The Display will indicate “**D/W**” and you will see the two monitored channels.

The Dual Watch function can be stopped in 5 different modes: by pressing the **PTT**- or the “**16**” buttons on the microphone, “**D/W**”- or “**C**”-buttons or by sending out a DSC-call.

- *Triple watch* – select one of the 2 channels you desire to monitor together with channel **16**. Hold pressed the function key corresponding to the written **T/W** until you hear two beeps. Now on the display appears the indication “**User**”.(F). Move now to the second channel you desire to monitor, press the function key corresponding to the indication **T/W**. Now you will see all three channels sliding on the display with indication **T/W**. “**Adv**” appears too, that, similar to **SCAN** function, has the aim to exclude momentarily the monitoring of the current channel. The Triple Watch function can be stopped by pressing the **C**-button, the **PTT**- or the **16**-buttons or by sending out a **DSC** call.

For both modes, the operation can be reassumed with the following diagram:

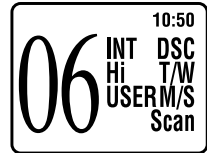

F

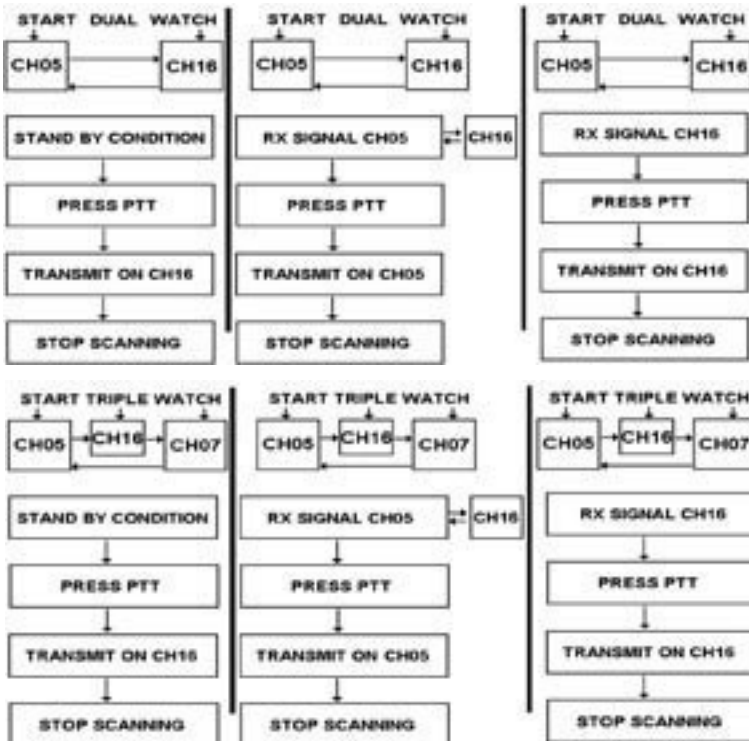

- ☞ Similar to scanning of marine channels, Dual Watch and Triple watch arrest when a signal is found and remain blocked for a few seconds after the signal disappears, in order to give the user a chance to respond to a call, if necessary.
- ☞ Dual/Triple Watch cannot function correctly if the squelch is not correctly regulated, as described in par .5.3.
- ☞ Because of regulations for inland waterways, Dual/Triple watch can not be activated in ATIS mode.

6.4 Memory channels (MEM mode)

6.4.a Memory scanning (SCAN MEMORY)

1. Similar to the scan function, memory scan will cycle sequentially through the channels, but only those, which have been pre-selected (at least 3).
2. Press the function key corresponding to the indication “M/S” (G). The radio emits 2 beeps and on the display appears for ca. 2 seconds the indication “M/S Sel” (H).
3. Select another channel and repeat the procedure mentioned above. In order to eliminate a channel erroneously inserted into scan cycle, select the channel, press and hold the function key corresponding to the indication “M/S” until the display shows “M/S Del” (I)
4. Once all channels are stored, the scanning can begin (SCAN MEMORY): Press the function key corresponding to the indication “M/S”. The channels will be monitored and the display will show the indication “M/S” – which indicates the scanning of the stored channels, - “Adv” and “Del” in relation to the 2 function keys. Every time a signal/disturb is found on a channel, the scanning stopps for a few seconds in order to give the user a chance to respond to the call or to cancel the channel, if necessary.

- ☞ Note: Scanning does not function correctly if the squelch is not regulated as described in par. 5.3.

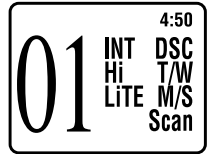

G

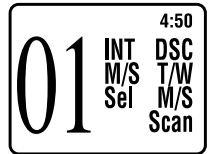

H



I

6.4.b Reception/Transmission during SCAN MEMORY

- **Reception:** If NEPTUNE finds a signal the scanning interrupts. The display indicates “RX” instead of “M/S” and the communication will be received through the loudspeaker.
- **Transmission:** It is possible to transmit at any time, also when the scanning is active. In that case NEPTUNE will always transmit on channel 16; if instead the transmission is done after a signal has been found, the device will transmit on the previously busy channel. After the transmission the scanning comes interrupted.

6.4.c To delete/To jump a pre-selected channel in memory

If during the scanning a signal is received on an undesired or disturbed channel, it is possible to cancel the channel in a definitive way or to jump the channel momentarily. In order to execute these functions, the radio must be syntonized on a channel (firm scanning). Through the two function keys corresponding to “Adv” and “Del” you will have the possibility to jump the busy channel respective to cancel it from the pre-selected list of channels.

There are 4 modes to stop the scanning of channels in memory:

1. By pressing the **PTT**-button.
2. By pressing the **16** button on the microphone or on the front panel
3. By pressing the **C**-button.
4. By sending out a **DSC**-Call.

7 USE WITH GPS

7.1 Function

If connected to a GPS receiver (GPS200), the transceiver will display the vessel position (latitude and longitude), as well as time data. If information regarding position data are not received, in the normal Radio Mode, time data do not appear and within 10 minutes a 1 minute-long warning will sound (see par. 10.12); if you want to disable it, press any button. The display will show 'POSITION IS OVER 4 HOURS OLD'. This tone will sound every 10 minutes until the position and time data are manually inserted. The user may also insert the coordinates manually as described in par. 10.6.

 *To disable the visual and acoustic message, see par. 10.12.*

7.2 GPS information on the display

Refer to the following illustrations:

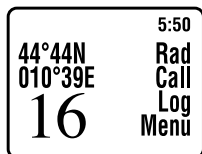

1



2

1. Position indicator

Displays GPS or manually-inserted coordinates.

2. Time indicator

Shows data supplied by the GPS or the transceiver's clock.

8 DIGITAL SELECTIVE CALLING (DSC)

8.1 Introduction

Digital Selective Calling is a semiautomatic method for controlling VHF, MF and HF radio calls. It was also designed as part of the global marine security and emergency response system (GMDSS). It is likely that DSC will eventually replace audio calls on emergency frequencies and will be used to send urgent and routine radio-transmitted maritime security information. This new service will allow crafts to send/receive calls of an emergency, urgent, security, or routine nature to/from vessels equipped with a DSC transceiver.

 **To avoid accidentally sending a distress call or a call sent incorrectly, contact your vendor or local authorities for updates on DSC operating and emergency procedures.**

 **In European inland waterways DSC-function is not allowed.**

8.2 Mobile Marine Identification Service (MMSI)

 *Important! To send/receive DSC calls, the user must program his personal MMSI code into the transceiver. This is a nine-digit number used by marine transceivers equipped for DSC digital selective calling. This number is used much like a telephone number for contacting other, specific vessels. For further details on programming your MMSI, see par. 10.10.*

8.3 Navigating the DSC menu

NEPTUNE offers many DSC functions. For this reason it was created a specific menu of settings and activations accessible via the function keys as follows:

1. Access the **CALL**-Menu by pressing the related function key.
 2. Press the function key corresponding to the word **Type** to select the type of desired call.
- ☐ *Once inside a sub-menu, you can return at any time to the main menu by pressing the **C**-button and terminating the current operation.*

8.4 Individual call (ROUTINE TO)

The user can carry out an individual call to a specific DSC station (a vessel or a costal station). To carry out calls, you have to enter the MMSI code manually or recall it from the preprogrammed MMSI directory. For further details on programming the MMSI directory, see par. 10.5.

8.4.a Sending an individual call

You can carry out an individual call using the following procedure:

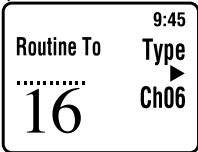
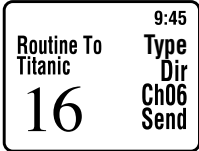
1. Press briefly the function key corresponding to **CALL**. On the display appears (J):
- 
- Display J shows: Routine To, 16, Type, Ch06, 9:45. A right-pointing arrow is next to Type.
2. The outlined line below under **Routine to** appears if no owner name was inserted in the column "Dir", otherwise a similar situation may appear (K):
- 
- Display K shows: Routine To, Titanic, 16, Type, Dir, Ch06, Send, 9:45.
3. Press the function key **Ch 06** to access the sub-menu.
 4. Press several times the function key **Chan** in order to select one of the 23 available channels (simplex channels) and confirm by pressing the **E**-button.
 5. Like mentioned above, it is possible, to insert manually the address you desire to call (using the alphanumerical keypad), or to select one of the addresses previously stored (maximum 16) by pressing several times the function key related to the word **DIR**.
 6. Then, after you have selected the communication channel and the address, the call can be carried out by pressing the function key corresponding to **Send** and confirmed by pressing the **E**-button.
 7. After the call execution the radio operates as follows:
 - If you have carried out a call to a ship, after the call you will get an answer, the radio will move to the channel previously selected under step 3-4.
 8. At this point:
 - *If the call comes confirmed from the other part*, the display shows the message: (L). In this case the answer is reached from ship 100000000 and the possible communication channel will be CH06. To confirm the reception of the received message, NEPTUNE will emit an acoustic message that can be interrupted by pressing the function key corresponding to **OK** or **STOP**. Pressing **OK** beyond interrupting the acoustic signalling, NEPTUNE is syntonized on the communication channel (in our example 06). If no function key comes pressed at that time (1 minute) the acoustic message will extinguish automatically.
 - *If the call does not come confirmed*, the display will indicate (M), by pressing the function key corresponding to **Stop** the radio will return to the normal radio mode.
- ☐ *Once inside a sub-menu, you can return at any time to the main individual **CALL**-menu (Routine to) by pressing the **C**-button and terminating the current operation.*

8.5 Group calling (Group Call)

This function allows the user to call a specific group of stations which have the same MMSI group code memorized in their transceivers and which signals the audio channel the user wishes to speak on. Therefore you can only carry out the group call when you have programmed the addresses in a directory like described in par. 10.10.

8.5.a Sending a group call

You can carry out a group call through following procedure:

1. Press briefly the function key corresponding to “**Call**”. On the display appears: (N)
2. Press three times the function key corresponding to “**Type**” in order to visualize on the display the following situation: (O)
3. The outlined line below under “**Group Call**” appears when no address has been programmed in the column “**Dir**”.
4. Press the function key “**Ch 06**” to access the sub-menu.
5. Press several times the function key “**Chan**” to select one of the 23 available channels (simplex channels) and confirm by pressing the **E**-button.
6. Like mentioned above, it is possible to insert manually the address of who is desired to call (using the alphanumerical keypad), or to select one of the addresses previously stored (maximum 16) by pressing several times the function key related to “**DIR**”.
7. Then, after you have selected the communication channel and the owner address, the call can be carried out by pressing the function key corresponding to “**Send**” and confirmed by pressing the **E**-button.
8. At this point you can communicate with the stations on the pre-selected channel that have given an answer to you.

☞ Once inside a sub-menu, you can return at any time to the main CALL-menu by pressing the **C**-button.

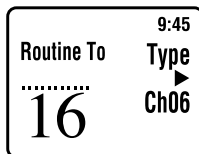

N

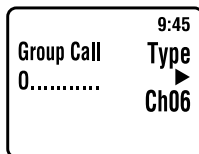

O

8.6 General call to all ships (ALL SHIP SAFETY – ALL SHIP URGENCY)

8.6.a Sending a call to all ships

☞ **Sending a distress call without founded reason is a criminal offence. Never use this function unless you find yourself in a situation that merits requiring help.**

1. You can carry out a call to all ships through following procedure:
2. Press the function key related to the written “**DSC**”.
3. Press the function key related to “**Call**”.
4. Press one time the function key “**Type**” in order to select the type of call **SAFETY**, otherwise press two times to select the type **URGENCY** (P-Q).
5. Select the type of desired call and press the function key corresponding to “**Send**”. Channel **16** is automatically selected and the display requests confirmation before sending the call with the message: (R)
6. At this point:
 - By pressing the function key corresponding to “**CH16**” and then “**CHAN**”, you can choose the calling channel.
 - If you wish to confirm the call, press the **E**-button to continue.
 - If you don't want to carry out the call (because of errors), press the **16**

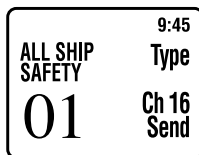

P

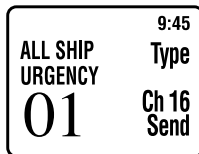

Q

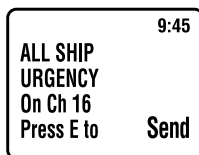

R

button or the “C”-button to leave this menu.

7. The call will be carried out on channel 70. The radio then will return to VHF mode on channel **16**.

☐ *During this procedure you are able to return to the main CALL-menu by pressing the C-button.*

8.7. DSC DISTRESS call

8.7.a Sending a DISTRESS call

☐ *IMPORTANT! You can only send a DSC call if you have been assigned an individual MMSI code and this code has been programmed into the transceiver (otherwise the following commands will be deactivated). For this operation, see par. 10.10.*

☞ **Sending a distress call without founded reason is a criminal offence. Never use this function unless you find yourself in a situation that merits asking for help.**

You can carry out the distress call through the following procedure:

1. Open the **DISTRESS** cover by pushing it to the right and hold it open.
2. Press momentarily the **DISTRESS**-button below. The display shows: (S)
3. Press the function key corresponding to “**Undefined**” in order to select the nature of the call (the pre-selection is UNDEFINED):

- A. **UNDEFINED**
- B. **ABANDONING**
- C. **PIRACY**
- D. **M.O.B.** (man over board)
- E. **FIRE**
- F. **FLOODING**
- G. **COLLISION**
- H. **GROUNDING**
- I. **LISTING**
- L. **SINKING**
- M. **ADRIFT**

4. To send out the distress call hold down the **DISTRESS**-button for 5 seconds. An acoustic alert will emit and the distress call will be carried out on channel 70 even when the channel is in use.
5. After the distress call, the transceiver will simultaneously check channel 70 and channel **16** on a receipt of **DSC** confirmation and meanwhile appears following: (T)
6. At this point:
 - *If the distress call is received and confirmed by another DSC radio station, the acoustic alarm will stop sounding and the display will return to normal use in VHF mode on channel **16**, sending on high transmission power.*
 - *If no confirmation is received, the device will re-send the distress call at intermissions of 3.5 – 4.5 minutes (even with channel 70 in use), until a confirmation is received or until the user manually cancels the call through the C-button.*

7. If, by mistake, the alarm note previously sent returns, we suggest that you send the message “**CANCEL**” to advise all the crafts earlier alerted.
- ☞ **Pressing button 16, the transceiver will return to normal VHF operation, but the call will not be cancelled and the person who responded to the call may not have called off rescue operations.**

☐ *If, at step 4, the user stops pressing the **DISTRESS** button before 5 seconds have elapsed, the distress call will not be sent. To exit and return to VHF mode, press button **16**.*

☐ *The acoustic alarm will only stop definitively once the transceiver has received confirmation from the receiver of the call.*

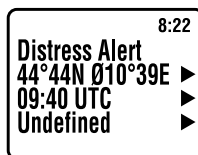

S

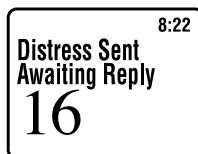

T

 It is possible to arrest the acoustic alarm by pressing the button **C** or **16**.

9 Receiving a DSC call

When the user receives a **DSC** call, the transceiver will automatically respond according to the type of call.

Information shown on the LCD display will vary according to the type of call. Refer to the diagram below for several examples:

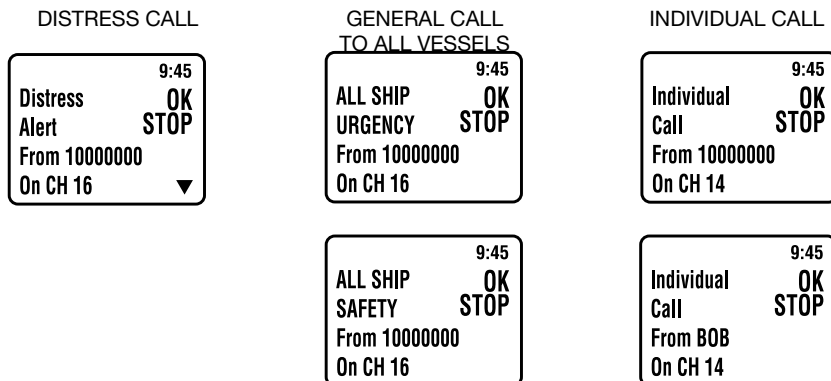

9.1.a Receiving a distress call

When the transceiver receives a distress call, an acoustic alarm will sound. The pressure to the function key "**STOP**" will deactivate the alarm.

When the signal also includes position and time data, these informations will appear on the display. If no position and time data are included in the signal, the display will indicate 99°99 999°99 88:88.

9.1.b General call to all ships

When the transceiver receives a general call related to all vessels, it automatically moves to the communication channel and emits an acoustic emergency alarm. The pressure of the function key "**STOP**" will deactivate the alarm.

9.1.c Individual call

When the transceiver receives an individual call, it automatically moves to the channel indicated by the **DSC** signal and emits a tone to alert the user of an incoming call. The pressure of the function key "**STOP**" will deactivate the alarm.

The MMSI owner code contained in the signal appears on the display. If the MMSI owner code has been programmed previously with name in the directory, the name of the caller appears too. Every time NEPTUNE receives a call (distress, individual or general) an entry will be stored in the list of registered calls "**LOG**".

10 CUSTOMIZATION

10.1 Menu settings

NEPTUNE can carry out a series of settings in order to personalize the transceiver to your requirements and to insert the necessary data to its operation.

10.2 Navigation in the menu of settings

To access the menu of setting use the functions keys.
All programmed settings are stored in non-volatile memory.

10.3 List of settings

Following find the possible settings:

Menu Items	Description	Par.
Log	Call directory of stored DSC calls type individual or distress calls.	10.4
Dir	Directory of MMSI owner names, MMSI codes and their details.	10.5
Posn	Manual programming of coordinates and the UTC time setting (in the absence of GPS).	10.6
LCD	Display contrast adjustment.	10.7
Beep	Adjustment of keypad beep	10.8
ZONE	Local and UTC time deviation settings.	10.9
MMSI	Entry of your individual MMSI code and you MMSI group code.	10.10
ATIS	Entry of your individual ATIS code (for navigation in inland waterways) and switching on/off the automatical transmission of the signal	10.11
GPS	Setting and CHECKSUM enabling/disabling – ACOUSTIC ALARM (in case of no GPS receiver connected) – DISPLAY (in case of no GPS receiver connected)	10.12

10.4 “ Log” (list of registered calls)

With this menu you can consult a directory of the latest registered calls, in analogous way to the registers of calls on a cellular phone.

1. Press the function key “**DSC**”.
2. Press the buttons “**DSC**” and “**Log**”. It will be shown the latest registered message.
3. By pressing the function key corresponding to “**Back**” all the other registered messages will be shown.
4. Using the function keys corresponding to the symbol “**▼**” you will get some more informations: coordinates and time.

10.5 “Dir” (Entries in the directory)

You can insert into the directory the MMSI codes from frequently called stations, by giving them a name (e.g. vessel or owner). Then you can search and use them more comfortably. When receiving a call, MMSI owner name and MMSI code will be displayed.

1. Press the function key “**Menu**”.
2. Press the function key “**More**”.
3. Press the function key “**Dir**”.
4. At this point you enter to the directory pages. If no MMSI owner address was stored, the display will show “**Empty**”, throughout it has been stored one or two MMSI owner addresses, the type of indication will appear as follows:
5. By pressing the function key “**Add**” you will have the possibility to add further MMSI addresses. By pressing the function key “**VIEW**” you will have the possibility to modify/cancel the address shown on the display.

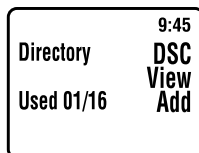

U

10.5.a Addition of addresses

1. Press the function key “**Add**”.
2. With the alphanumerical keypad (the keys are associated with letters like on a cellular phone) you are able to write the name you want to associate with the MMSI code (f.e. TOM), then press the **E**-button to confirm.
3. After the pressure to the **E**-button, on the display appears th cursor in correspondence to “**MMSI**”
Write the identification code using the alphanumerical keypad (obligatorily 9 digits)
4. Press the **E**-button to confirm.

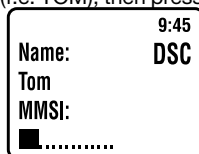

V

10.5.b To modify/cancel addresses

1. Press the function key “**View**”.
2. Select with the function keys “**Next**” or “**Back**” the address you desire to modify/cancel.
3. Press the function key “**Edit**”.
4. If you desire to change the name or the code, press one of the 2 function keys associated to the name or the MMSI code “**▶**”.
5. If it is desired to eliminate completely the directory, press the function key “**Del**” and confirm by pressing subsequently the function key “**Yes**”.



W

- If it is desired to cancel the operation, press the function key “**NO**”.
- ☞ *It is possible to memorize max. 16 addresses. If the directory is filled up, on the display will appear the indication “**Full**” and it will not be possible to add further addresses. In this case it is necessary to cancel some.*

10.6 “Posn”(Setting of position coordinates and adjustment of UTC time)

1. Press the function key “**DSC**”.
2. Press the key “**Menu**”.
3. Press the key “**Posn**”.
4. To insert the coordinates press the function key “**Posn**” and through the alphanumerical keypad set up the coordinates.
5. Confirm by pressing the **E**-button. If “nonexistent” coordinates have been inserted, Neptune will emit a double error beep rendering necessary the re-insertion.
6. In order to set the time, press the function key corresponding to “**UTC**” and confirm through the **E**-button the executed operation. An eventual error message will indicate the wrong entry

of time data.

- ☐ *To get the best performance with DSC capability, we suggest inserting the coordinates and time. If Neptune is connected to a compatible GPS receiver (GPS 200) the setting of these data is not compulsory.*

10.7 "LCD" (display contrast)

The user can adjust the display contract to optimise visibility according to ambient conditions.

1. Press the function key "**DSC**".
2. Press the function key "**Menu**".
3. Press the function key "**LCD**".
4. Using the function keys corresponding to "**▲**"; "**▼**" you can increase the contrast of the display.
5. Confirm by using one of the following buttons: **C**, **16**, function key **DSC**, or the **PTT**.

- ☐ *This setting remains stored on the Eeprom, therefore NEPTUNE will maintain the same settings when the radio is turned on again.*

10.8 "Beep" (Enable/disable keypad beep)

In order to activate or to inhibit the beep to the pressure of the keys operate as follows:

1. Press the function key "**DSC**".
2. Press the function key "**Menu**".
3. Press the function key "**More**".
4. Press the function key "**More**".
5. Pressing the function key "**Beep**" activates or disables the acoustic message to the pressure of the keys.

- ☐ *This setting remains stored on the Eeprom, therefore NEPTUNE will maintain the same settings when the radio is turned on again.*

10.9 "ZONE" (Adjustment of UTC time deviation)

The user can program the time deviation with respect to the UTC time so the transceiver's display will show the time for the current time zone.

1. Press the function key "**DSC**".
2. Press the function key "**Menu**".
3. Press the function key "**More**".
4. Press the function key "**More**".
5. Push the function key "**More**" again.
5. Press the function key "**Zone**".
6. The display will show (X)
7. Pressing the function keys +, or -, will set the desired deviation.

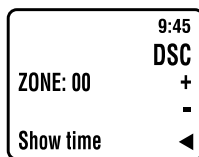

8. Acting with the function key ◀ will activate or eliminate the visualization of the time data on the display.
9. Confirm by pressing one of the following buttons: **C**, **16**, function key **DSC**, or **PTT**.

- ☐ *This setting remains stored on the Eeprom, therefore NEPTUNE will maintain the same settings when the radio is turned on again.*

10.10 MMSI (Setting of personal MMSI code and MMSI group code)

This function allows the user to insert their personal MMSI identification code assigned by an appropriate authority.

Be careful to insert the correct personal MMSI code. Once the code has been saved, it cannot be modified.

1. Press the function key **"DSC"**.
2. Press the function key **"Menu"**.
3. Press the function key **"More"**.
4. Press the function key **"MMSI"**. The display will show:
5. To insert the personal MMSI code press the function key to the right under the arrow corresponding to the script **"DSC"**. The display will show the message **"Enter MMSI" (Y)**
6. Insert the 9 digits, for example 900000000 and press the **E**-button in order to confirm, now on the display appears: (Z)
7. To program the MMSI code, press the function key corresponding to **"▶"** situated right below.
8. On the display will appear the message **"Enter Group MMSI"**, now program 8 numbers (the first fixed number is 0 (zero)) and confirm by pressing the **E**-button.

It is possible to change the MMSI group code whenever you want, while the personal MMSI code can be inserted only one time; for this reason, we recommend to pay attention.

If you have accidentally inserted an incorrect code, you will have to return the device to your approved vendor for a complete reset.

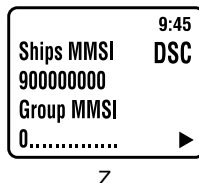
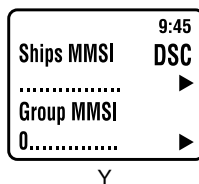

10.11 "ATIS" (Setting of ATIS code and activation - deactivation of automatical transmission)

Be careful to insert the correct code. Once the code has been saved, it cannot be modified.

1. Press the function key **"DSC"**.
2. Press the function key **"Menu"**.
3. Press the function key **"More"**.
4. Press the function key **"More"**.
5. Press the function key **"Atis"**.
6. The display will show: (AA)
7. Press the key corresponding to **▶**.
8. On the display will appear the message **"Enter atis MMSI"**. The ATIS ID number is a ten-digit number (given by the authorities), always beginning with "9". The first number "9" is stored already, thus it is need only to enter the following 9 digits. Example: You received from the authorities the ATIS code 9 211015923.
9. Insert the last 9 digits 211015923 and confirm by pressing the **E**-button. The display will show: (AB)

Your marine transceiver is able to activate, if necessary, an automatic transmission of your ATIS identification code each time the **PTT** is released. This function is only used when navigating in internal navigable European waters which require automatic transmission of identification. The user can request an ATIS code from the same organization in their community which licenses radio operators. Program the code as descri-

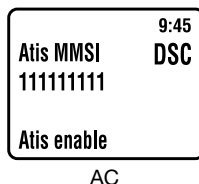
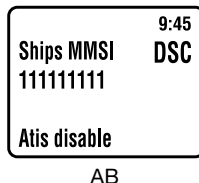
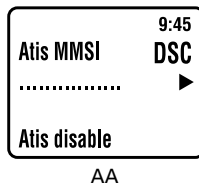

bed previously.

1. In order to activate it, press the function key correspondent to “**Atis disable**”. On the display will appear: (AC)
2. Confirm by pressing one of the following buttons: **16, C** or **PTT**.
3. When the ATIS function is activated, “ATIS” will appear on the upper part of the display.
 If regulations in your community do not allow you programming the ATIS code by yourself, contact your approved vendor for programming.
 Activate the ATIS code only when requested by the proper authorities.
 We remember that when the ATIS function is activated, DSC call are disabled.

10.12 GPS RECEIVER SETTING

In this menu you can set the type of string the receiver of your NEPTUNE can accept and set the visual and acoustic signals. To enter this menu, follow the procedure here below:

1. Press the key **Function “DSC”**
2. Press the key **Function “Menu”**
3. Push the key **Function “More”**
4. Push the control **Function “ More”**
5. Push it again.
6. Press the key **Function “GPS”**

The following are all the possible messages displayed:

- **CHECKSUM OFF** (default setting): in this mode, all the GPS receivers can be decoded by your NEPTUNE.
- **CHECKSUM ON**: NEPTUNE decodes only the GPS200 receiver or others using a GPGGA string of the same format.
- **WARN BEEP OFF** (default setting in case the GPS is not connected to your NEPTUNE): the acoustic signal won't be emitted.
- **WARN BEEP ON**: the acoustic signal will be emitted.
- **DISPLAY ON** (default setting): in case a GPS receiver is not connected to your NEPTUNE, the display will show a message advising there's no connection to the receiver (POSITION IS OVER 4 HOURS OLD POSN”: it will be displayed every 10 minutes).
- **DISPLAY OFF**: in this condition, there will be no message displayed on your NEPTUNE because the transceiver is not connected to any GPS receiver.

11 Programming and selection of private channels

Only authorized customers are allowed to use private channels. For the use in Germany an additional license is requested. For detailed informations contact your local radio communications authorities. To program the private channels, it is necessary to connect the programming kit PRG-NEPTUNE (optional). PRG-Neptune is connectable to a PC with COM port. Once have been programmed private channels (maximum 20), they can be selected in the following way:

1. Press one of the 10 numerical keys (0,1,2, etc).
2. Move through the 2 function keys correspondent to “PUT ▲” or “PUT ▼”, than select the desired channel.
3. Confirm by pressing the **E**-button.
Like all other channels in use, the private channels can be merged with all the functions described previously (Dual watch, Triple watch, Memory Scan etc.)

12 MAINTENANCE

12.1 Maintenance and warnings

NEPTUNE is a marine VHF transceiver that conforms to IP54 standard, making the transceiver very reliable when used correctly.

The device was designed so as to avoid requiring maintenance. To keep your transceiver in optimal operating conditions:

- 🔊 **Never open the device (transceiver or microphone) as this may compromise the water resistant seal.**
- 🔊 **If the device becomes dirty or dusty, do not use alcohol, solvents or abrasives to clean it. Use only a soft cloth, slightly dampened with water. For more persistent cases, use a mild detergent.**

13 TROUBLESHOOTING

Problem	Possibile causes	Solution	Rifer.
Device doesn't turn on	Power supply is not correctly connected	Verify that power supply is properly connected	4.7.a
	The protection fuse has shorted (located on the power cable)	Verify the cause of the problem and substitute the fuse	-
Device turns on, but doesn't receive signals	Antenna is not correctly connected	Verify that antenna is properly connected	4.7.c
	Volume level is too low	Adjust volume level	5.2
	Squelch level is too high	Adjust squelch level	5.3
Unable to contact another party	Incorrect marine channel selected	Verify channel and, if necessary, change channel	5.4
Other party has difficulty in hearing you	Distance is too far and low transmission power (LO) was accidentally selected	Select high transmission power (HI)	5.6
Reception is broken and/or disturbed	Squelch level is too high	Adjust squelch level	5.3
	Signal is too weak (other party is too far away and/or antenna is blocked by obstacles)	Try to completely open the squelch and/or move closer to the other party	5.3
	Other users are using the same radio channel	Verify radio traffic on desired channel and, if necessary, change channel	5.4
	Other interference devices (televisions, computers, transceivers, etc.) too close to NEPTUNE	Move other interference devices further from NEPTUNE	-
Impossible to transmit or use high transmission power	Some channels operate only on low power or are only for reception	Tune to another channel	5.4
DSC , MMSI or ATIS functions unusable	Individual MMIS and/or ATIS codes have not been programmed	Program the codes	10.10 10.11
Vessel battery runs down sooner than expected	Excessive use of transmission	Try to reduce transmission times and/or use low transmission power	5.6
Scanning and/or Dual/Triple Watch malfunctioning	Squelch has not been correctly adjusted	Adjust squelch level	5.3

14 TECHNICAL SPECIFICATIONS

Channels	All 57 international marine channels, see section 15, with programming for ships under flag of Norway, Denmark, Finland, Great Britain, the Netherlands and Belgium following special usual channels are possible: channels 31, 96H, 37A, P4, L1, L2, L3, F1, F2, F3.
Frequency generation.....	PLL synthesizer
Frequency range	TX from 156.025 to 157.424 MHz RX from 156.300 to 162.000 MHz
Antenna Impedance	50 Ohm
Power supply	12 Vdc
Operating temperature	from -15°C to +55°C
Size (HxLxW)	70x160x170 mm
Weight (device only)	1.305 Kg

14.1 Transmitter

Output power	High (HI): 25W/Low (LO):1W
Modulation Type.....	FM
Microphone	condenser type
Hum and noise attenuation	34dB
Audio distortion	5%
Harmonics reduction	HI: 80dB/LO:60dB

14.2 Receiver

Sensitivity @ 20 dB Sinad.....	<0.5 μ V
S/N ratio (20dB).....	0,8 μ V
Squelch sensitivity.....	threshold -12dB μ V (EMF)
Adjacent channel rejection	70dB
Audio output power.....	>2W su 8 Ohm
Audio distortion	10%

ⓘ Note: these values are average. Actual values may be subject to variation.

15 Frequency Table

INTERNATIONAL (INT)				
CH	Frequency (MHz)			
	TX	RX	Mode	Note
01	156.050	160.650	D	
02	156.100	160.700	D	
03	156.150	160.750	D	
04	156.200	160.800	D	
05	156.250	160.850	D	
06	156.300	156.300	S	
07	156.350	160.950	D	
08	156.400	156.400	S	
09	156.450	156.450	S	
10	156.500	156.500	S	
11	156.550	156.550	S	
12	156.600	156.600	S	
13	156.650	156.650	S	
14	156.700	156.700	S	
15	156.750	156.750	S	*
16	156.800	156.800	S	
17	156.850	156.850	S	*
18	156.900	161.500	D	
19	156.950	161.550	D	
20	157.000	161.600	D	
21	157.050	161.650	D	
22	157.100	161.700	D	
23	157.150	161.750	D	
24	157.200	161.800	D	
25	157.250	161.850	D	
26	157.300	161.900	D	
27	157.350	161.950	D	
28	157.400	162.000	D	
60	156.025	160.625	D	
INTERNATIONAL (INT)				

CH	Frequency (MHz)			
	TX	RX	Mode	Note
61	156.075	160.675	D	
62	156.125	160.725	D	
63	156.175	160.775	D	
64	156.225	160.825	D	
65	156.275	160.875	D	
66	156.325	160.925	D	
67	156.375	156.375	S	
68	156.425	156.425	S	
69	156.475	156.475	S	
70	156.525	156.525	S	**
71	156.575	156.575	S	
72	156.625	156.625	S	
73	156.675	156.675	S	
74	156.725	156.725	S	
75	156.775	156.775	S	*
76	156.825	156.825	S	*
77	156.875	156.875	S	
78	156.925	161.525	D	
79	156.975	161.575	D	
80	157.025	161.625	D	
81	157.075	161.675	D	
82	157.125	161.725	D	
83	157.175	161.775	D	
84	157.225	161.825	D	
85	157.275	161.875	D	
86	157.325	161.925	D	
87	157.375	157.375	S	
88	157.425	157.425	S	

S= Simplex

D= Duplex

*= obligatory low transmission power of 1 Watt

**= classified to DSC communications