



INSTRUCTION MANUAL

VHF MARINE TRANSCEIVER IC-M91D

Icom Inc.



FOREWORD

Thank you for purchasing this Icom product. The IC-M91D VHF MARINE TRANSCEIVER are designed and built with Icom's state of the art technology and craftsmanship. With proper care this radio should provide you with years of trouble-free operation.

IMPORTANT

READ ALL INSTRUCTIONS carefully and completely before using the transceiver.

SAVE THIS INSTRUCTION MANUAL—This instruction manual contains important operating instructions for the IC-M91D.

This instruction manual includes some functions which are usable only when they are pre-programmed by your dealer. Ask your dealer for details.

EXPLICIT DEFINITIONS

WORD	DEFINITION
⚠ DANGER!	Personal death, serious injury or an explosion may occur.
⚠ WARNING!	Personal injury, fire hazard or electric shock may occur.
CAUTION	Equipment damage may occur.
NOTE	If disregarded, inconvenience only. No risk of personal injury, fire or electric shock.

FEATURES

👉 Floats on water

The transceiver floats in fresh or salt water even when the supplied accessories are attached.

- When a third-party battery pack, strap, antenna, and so on is used, it may sink.

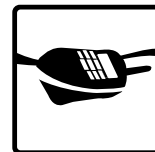

👉 Floats and flashes

When the transceiver detects that it has come in contact with water, the LCD backlight, keys and trim start to blink, making it easy to find the transceiver even at night or in a dark environment.

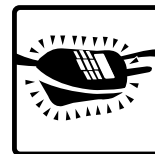

IN CASE OF EMERGENCY

If your vessel requires assistance, contact other vessels and the Coast Guard by sending a distress call on Channel 16.

USING CHANNEL 16 **DISTRESS CALL PROCEDURE**

1. "MAYDAY MAYDAY MAYDAY."
2. "THIS IS" (name of vessel).
3. Say your call sign or other indication of the vessel (AND your 9-digit DSC ID, if you have one).
4. "LOCATED AT" (your position).
5. State the nature of the distress and assistance required.
6. Give any other information which might facilitate the rescue.

Or, transmit your Distress call using digital selective calling on Channel 70.

USING DIGITAL SELECTIVE CALLING (Ch 70) **DISTRESS CALL PROCEDURE**

1. While lifting up the key cover, hold down [DISTRESS] for 3 seconds until you hear 3 short beeps and then one long beep.
2. Wait for an acknowledgment on Channel 70 from a coast station.
 - After the acknowledgement is received, Channel 16 is automatically selected.
3. Push and hold [PTT], then transmit the appropriate information as listed to the left.

RECOMMENDATION

CLEAN THE TRANSCEIVER THOROUGHLY WITH FRESH WATER after exposure to saltwater. Otherwise, the transceiver's keys, switches and controllers may become inoperable due to salt crystallization.

NOTE: DO NOT wash the transceiver in water if there is any reason to suspect the waterproofing may not be effective. For example, in cases where the battery pack rubber seal is damaged, the transceiver/battery pack is cracked or broken, or has been dropped, or when the battery pack is detached from the transceiver.

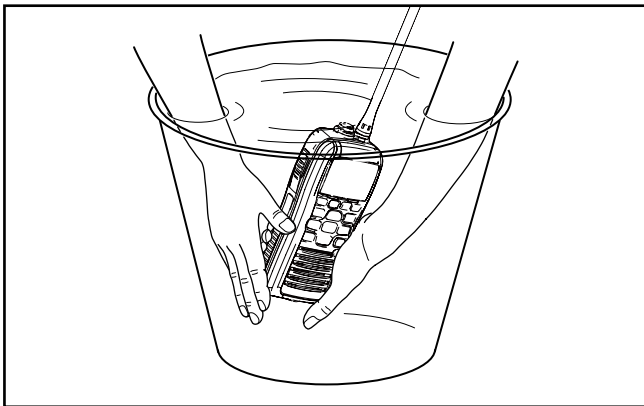

PRECAUTIONS

⚠ WARNING! NEVER connect the transceiver to an AC outlet. This may pose a fire hazard or result in an electric shock.

⚠ WARNING! NEVER hold the transceiver so that the antenna is very close to, or touching exposed parts of the body, especially the face or eyes, while transmitting. The transceiver will perform best if the microphone is 5 to 10 cm away from the lips and the transceiver is vertical.

⚠ WARNING! NEVER operate the transceiver with other audio accessories at high volume levels. Hearing experts advise against continuous high volume operation. If you experience a ringing in your ears, reduce the volume level or discontinue use.

DO NOT modify the transceiver. The transceiver warranty does not cover any problems caused by unauthorized modification.

BE CAREFUL! The transceiver will become hot when operating it continuously for long periods of time.

KEEP the transceiver and microphone at least 1 m away from the vessel's magnetic navigation compass.

KEEP the transceiver out of the reach of children.

PRECAUTIONS

CAUTION: MAKE SURE the flexible antenna, battery pack and jack cover are securely attached to the transceiver, and that the antenna and battery pack are dry before attachment. Exposing the inside of the transceiver to dust or water will result in serious damage to the transceiver.

DO NOT operate the transceiver near unshielded electrical blasting caps or in an explosive atmosphere.

DO NOT push [PTT] when not actually intending to transmit.

DO NOT use or place the transceiver in direct sunlight or in areas with temperatures below -15°C or above $+55^{\circ}\text{C}$.

The basic operations, transmission and reception of the transceiver are guaranteed within the specified operating temperature range. However, the LCD display may not be operate correctly, or show an indication in the case of long hours of operation, or after being placed in extremely cold areas.

DO NOT use harsh solvents such as benzine or alcohol when cleaning, as they will damage the transceiver surfaces.

BE CAREFUL! The IC-M91D meets IPX7* requirements for dust-tight and waterproof protection. However, once the transceiver has been dropped, dust-tight and waterproof protection cannot be guaranteed because of possible damage to the transceiver's case or the waterproof seal.

* Only when the jack cover or the optional HM-167 is attached.

Even when the transceiver power is OFF, a slight current still flows in the circuits. Remove the battery pack or batteries from the transceiver when not using it for a long time. Otherwise, the installed battery pack or batteries will become exhausted, and will need to be recharged or replaced.

BE CAREFUL! Even if the volume level is set low, the beeps of the Float 'n Flash, DSC alarm and AquaQuake functions are very loud.

MAKE SURE to turn the transceiver power OFF before connecting the supplied/optional equipment.

TABLE OF CONTENTS

FOREWORD	i	5 BASIC OPERATION	12–17
IMPORTANT	i	■ Channel selection	12
EXPLICIT DEFINITIONS	i	■ Call channel programming	13
FEATURES	i	■ Adjusting the volume level	14
IN CASE OF EMERGENCY	ii	■ Adjusting the squelch level	14
RECOMMENDATION	iii	■ Receiving and transmitting	14
PRECAUTIONS	iii–iv	■ Lock function	15
TABLE OF CONTENTS	v–vi	■ Monitor function	15
COUNTRY CODE LIST	vi	■ AquaQuake water draining function	16
1 OPERATING RULES	1	■ Backlight setting	16
2 SUPPLIED ACCESSORIES AND ATTACHMENTS	2–3	■ Channel name programming	16
■ Supplied accessories	2	6 SCAN OPERATION (Except for the Dutch version) ..	18–19
■ Attachments	2	■ Scan types	18
3 PANEL DESCRIPTION	4–9	■ Setting Favorite channels	19
■ Front, top, side and rear panels	4	■ Starting a scan	19
■ Softkeys	6	7 DUALWATCH/TRIWATCH	20
■ Function display	7	■ Description	20
■ Softkey function	9	■ Operation	20
4 PREPARATION	10–11	8 DSC OPERATION	21–64
■ MMSI code programming	10	■ DSC address ID	21
■ ATIS code programming	11	■ Position and time programming	24
		■ Distress call	25
		■ Transmitting DSC calls	29
		■ Receiving DSC calls	46
		■ Received Call log	58

TABLE OF CONTENTS

■ Transmitted Call log.....	60
■ DSC Settings	61
9 OTHER FUNCTIONS	65–75
■ MOB (Man OverBoard)	65
■ Waypoint	68
■ Navigation	72
■ Compass screen	74
■ GPS status screen	74
10 MENU SCREEN OPERATION.....	76–82
■ Menu screen operation	76
■ Menu screen items.....	77
■ Radio Settings items	78
■ Configuration items	79
11 BATTERY CHARGING.....	83–87
■ Battery caution.....	83
■ Regular battery charger	85
■ Optional battery chargers.....	86
12 OPTIONAL SPEAKER-MICROPHONE.....	88
■ HM-167 descriptions	88
■ Attachment.....	88
13 TROUBLESHOOTING.....	89
14 SPECIFICATIONS AND OPTIONS.....	90–91
■ Specifications	90
■ Options.....	91
15 CHANNEL LIST	92

COUNTRY CODE LIST

• ISO 3166-1

	Country	Codes		Country	Codes
1	Austria	AT	18	Liechtenstein	LI
2	Belgium	BE	19	Lithuania	LT
3	Bulgaria	BG	20	Luxembourg	LU
4	Croatia	HR	21	Malta	MT
5	Czech Republic	CZ	22	Netherlands	NL
6	Cyprus	CY	23	Norway	NO
7	Denmark	DK	24	Poland	PL
8	Estonia	EE	25	Portugal	PT
9	Finland	FI	26	Romania	RO
10	France	FR	27	Slovakia	SK
11	Germany	DE	28	Slovenia	SI
12	Greece	GR	29	Spain	ES
13	Hungary	HU	30	Sweden	SE
14	Iceland	IS	31	Switzerland	CH
15	Ireland	IE	32	Turkey	TR
16	Italy	IT	33	United Kingdom	GB
17	Latvia	LV			

Icom, Icom Inc. and the Icom logo are registered trademarks of Icom Incorporated (Japan) in Japan, the United States, the United Kingdom, Germany, France, Spain, Russia and/or other countries.

◇ **Priorities**

- Read all rules and regulations pertaining to priorities and keep an up-to-date copy handy. Safety and distress calls take priority over all others.
- You must monitor Channel 16 when you are not operating on another channel.
- False or fraudulent distress calls are prohibited under law.

◇ **Privacy**

- Information overheard but not intended for you cannot lawfully be used in any way.
- Indecent or profane language is prohibited.

◇ **Radio licenses**

(1) SHIP STATION LICENSE

You must have a current radio station license before using the transceiver. It is unlawful to operate a ship station which is not licensed.

Inquire through your dealer or the appropriate government agency for a Ship-Radiotelephone license application. This government-issued license states the call sign which is your craft's identification for radio purposes.

(2) OPERATOR'S LICENSE

A Restricted Radiotelephone Operator Permit is the license most often held by small vessel radio operators when a radio is not required for safety purposes.

The Restricted Radiotelephone Operator Permit must be posted or kept with the operator. Only a licensed radio operator may operate a transceiver.

However, non-licensed individuals may talk over a transceiver if a licensed operator starts, supervises, ends the call and makes the necessary log entries.

A current copy of the applicable government rules and regulations is only required to be on hand for vessels in which a radio telephone is compulsory. However, even if you are not required to have these on hand it is your responsibility to be thoroughly acquainted with all pertinent rules and regulations.

■ Supplied accessories

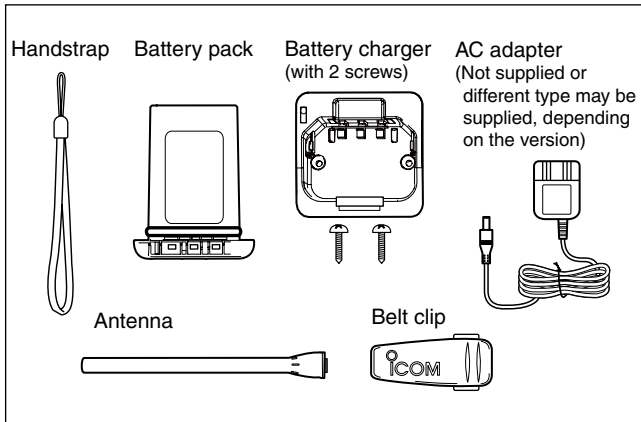

■ Attachments

◇ Flexible antenna

Connect the supplied flexible antenna to the antenna connector.

CAUTION:

- NEVER carry the transceiver by holding the antenna.
- Transmitting without an antenna may damage the transceiver.

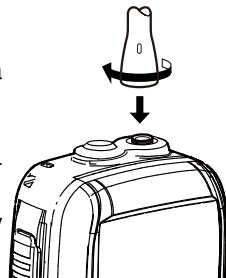

◇ Handstrap

Pass the handstrap through the loop on the back side of the transceiver as illustrated at right. This facilitates carrying.

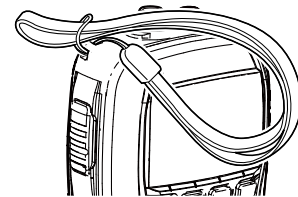

◇ Belt clip

Attach/detach the belt clip to the transceiver as illustrated below.

To attach the belt clip

To detach the belt clip

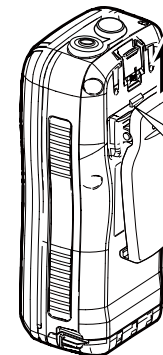
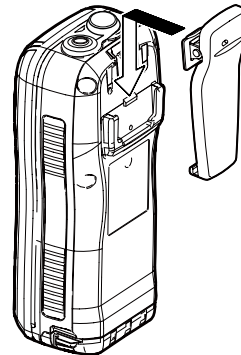

Be careful!
Do not break your finger nails.

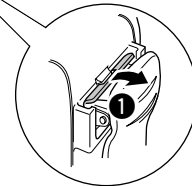

2 SUPPLIED ACCESSORIES AND ATTACHMENTS

◇ Battery pack

To remove the battery pack:

Turn the screw counter clockwise one quarter turn, then pull the battery pack in the direction of the arrow, as shown below.

To attach the battery pack:

Insert the battery pack completely into the transceiver, then turn the screw clockwise one quarter turn.

NEVER remove or insert the battery pack when the transceiver is wet or soiled. This may result water or dust getting into the transceiver or battery pack and may result in the transceiver being damaged.

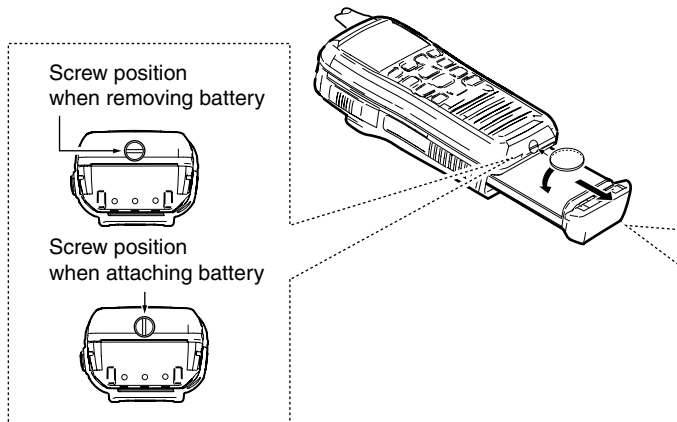

NOTE: When removing or attaching the battery pack, use a coin or standard screwdriver to loosen or tighten the bottom screw.

CAUTION:

When attaching or removing a battery pack, make sure the rubber seal is set in the groove of the battery pack correctly. If the seal is not correctly in the groove, it may be damaged when attaching the battery pack. If the seal is damaged, waterproof protection is not guaranteed.

NOTE:

When attaching a battery pack, make sure dust or other material does not adhere to the rubber seal. If dust or other material is on the seal when attaching a battery pack, waterproof protection may not be guaranteed.

Make sure the rubber seal is properly seated in the groove and dust or other material does not adhere to it.

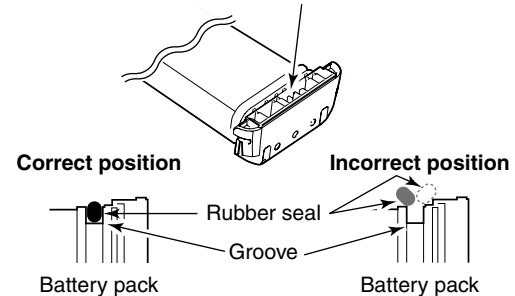

■ Front, top, side and rear panels

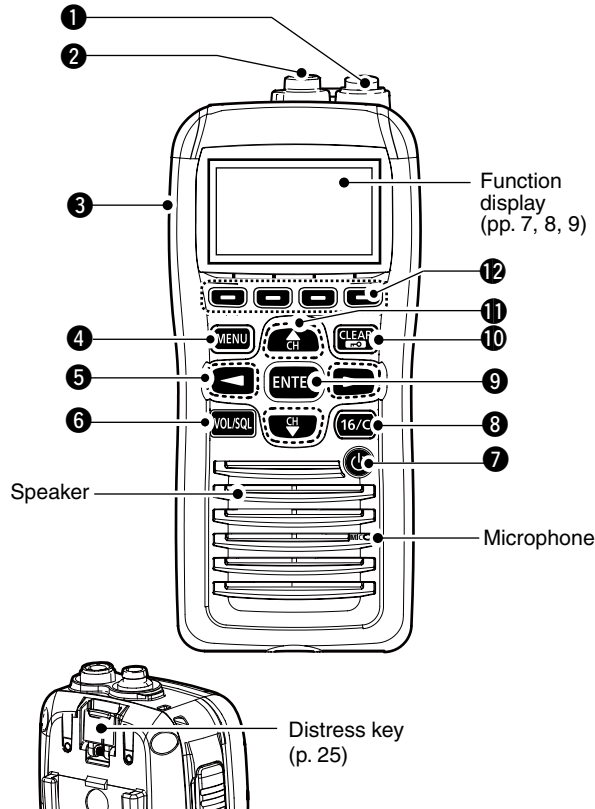

❶ ANTENNA CONNECTOR (p. 2)

Connects to the supplied antenna.

❷ SPEAKER-MICROPHONE CONNECTOR [SP MIC] (p. 88)

Connects to the optional external speaker-microphone.

NOTE: Attach the [SP MIC] cap when the optional speaker-microphone is not used. Otherwise, water will get into the transceiver.

❸ PTT SWITCH [PTT]

Hold down to transmit; release to receive. (p. 14)

❹ MENU KEY

Push to enter or exit the Menu screen.

❺ LEFT AND RIGHT KEYS [◀]/[▶]

- ➔ Push to switch to the previous or next key function that is assigned to the softkeys. (p. 9)
- ➔ Push to select the desired character or number in the table while in the channel name, position, MMSI code programming mode, and so on. (pp. 10, 16, 24)

❻ VOLUME/SQUELCH KEY [VOL/SQ]

- ➔ Push to enter the volume level adjustment mode. (p. 14)
- ➔ Push again while in the volume level adjustment mode to enter the squelch level adjustment mode.
- ➔ Hold down for 1 second to activate the monitor function. (p. 15)

❼ POWER KEY [⏻]

Hold down for 1 second to turn the power ON or OFF.

3 PANEL DESCRIPTION

■ Front, top and rear panels (Continued)

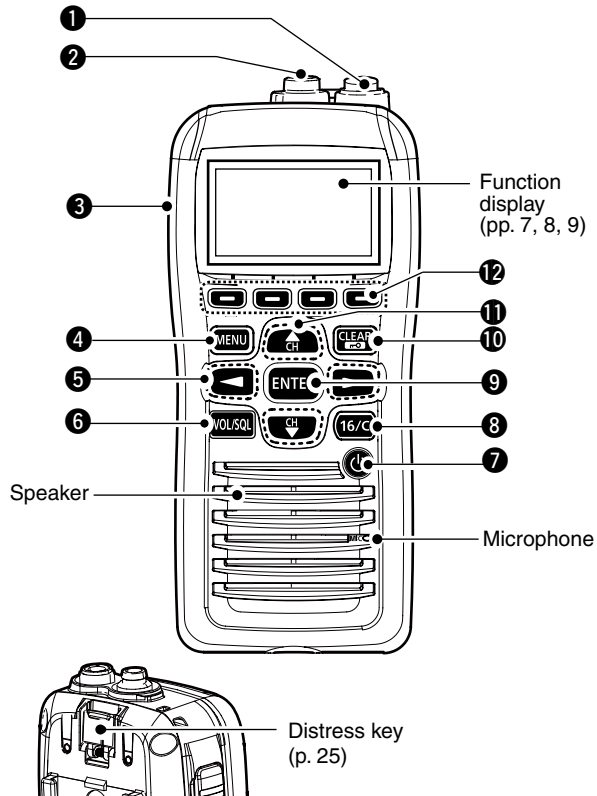

8 CHANNEL 16 KEY [16/C]

- Push to select Channel 16. (p. 12)
- Hold down for 1 second to select the Call channel. (p. 12)
- Hold down for 3 seconds to enter the Call channel programming mode when the Call channel is selected. (p. 13)

9 ENTER KEY

Push to set the input data, selected item, and so on.

10 CLEAR/LOCK KEY [↵]

- Push to cancel the entered data, or to return to the previous screen.
- Hold down for 1 second to turn the key lock function ON or OFF. (p. 15)

11 UP AND DOWN/CHANNEL SELECT KEYS [▲•CH]/[▼•CH]

- Push to select the operating channels, Menu items, Menu settings, and so on. (p. 77)
- Push to check Favorite (TAG) channels, change the scanning direction or manually resume a scan. (p. 19)

12 SOFTKEYS

Slide the menu by pushing the [◀]/[▶] keys, then push either of the 4 softkeys to select a menu displayed at the bottom of the LCD display.

See Softkeys on the next page for more details. (p. 6)

■ Softkeys

The desired functions as described below can be assigned in the Menu screen.

Scan [SCAN]* (p. 18)

Push to start or stop a Normal or Priority scan.

* Except for the Dutch version.

Dualwatch/Tri-watch [DW] (p. 20)

➤ Push to start a Dualwatch or Tri-watch*.

➤ Push to stop a Dualwatch or Tri-watch when either is activated.

* Except for the Dutch version.

High/Low [HI/LO] (p. 14)

Push to set the power to high or low.

• Some channels are set to only low power.

Channel [CHAN] (p. 12)

Push to select either the regular channels.

AquaQuake [AQUA] (p. 16)

While holding down, the AquaQuake function is activated to clear water away from the speaker grill.

Favorite channel [★] (p. 19)

➤ Push to set or clear the displayed channel as a Favorite (Tag) channel.

➤ Hold down for 3 seconds to clear or set all Favorite channels in the selected channel group.

Name [NAME] (p. 16)

Push to enter the channel name programming mode.

Backlight [BKLT] (p. 16)

Push to enter the LCD and key backlight brightness adjustment mode.

• While in the adjustment mode, push [▲]/[▼][◀]/[▶] to adjust the brightness of the LCD and key backlight.

MOB [MOB] (p. 65)

➤ Push to enter "MOB" in the menu screen.

➤ Hold down for 1 second to memorize the current position as the MOB (Man OverBoard) point.

Waypoint [WP] (p. 68)

➤ Push to enter "WAYPOINT" in the menu screen.

➤ Hold down for 1 second to memorize the current position as a Waypoint.

3 PANEL DESCRIPTION

■ Softkeys (Continued)

Navigation [**NAV**] (p. 72)

After holding down [MOB], or in the MOB or Waypoint list screen, push this key to start navigating to the selected position.

Compass [**COMP**] (p. 74)

Push to display the compass screen to show the vessel's course heading, SOG (Speed Over Ground) and COG (Course Over Ground).

Log [**LOG**] (p. 58)

Push to enter "RCVD CALL LOG" in the DSC CALLS menu.

■ Function display

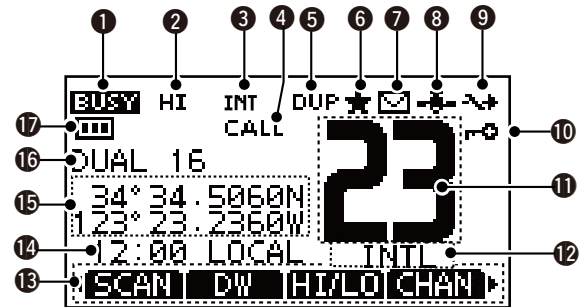

❶ **BUSY/TRANSMIT INDICATOR** (p. 14)

- "BUSY" appears when receiving a signal or when the squelch opens.
- "TX" appears while transmitting.
- "MONI" appears while the monitor function is activated.

❷ **POWER ICON** (p. 14)

- "HI" appears when high power is selected.
- "LOW" appears when low power is selected.

❸ **CHANNEL GROUP ICON** (p. 13)

Shows which channel group is selected, a U.S.A. "USA," International "INT," ATIS "ATIS" or DSC "DSC", depending on the transceiver version.

❹ **CALL CHANNEL ICON** (p. 12)

Appears when Call channel is selected.

5 DUPLEX ICON (p. 13)

Appears when a duplex channel is selected.

6 FAVORITE CHANNEL ICON (p. 19)

Appears while a Favorite (TAG) channel is selected.

7 MESSAGE ICON (p. 46)

Blinks when there is an unread message.

8 GPS ICON

- Stays ON while the GPS data is received, and a valid position is received.
- Blinks when an invalid position is being received.

9 SWITCH ICON (p. 62)

Appears when the “CH 16 SWITCH” in DSC Settings is set to ‘OFF.’

10 LOCK ICON (p. 15)

Appears while the lock function is activated.

11 CHANNEL NUMBER READOUT

Shows the selected operating channel number.

- When a simplex channel is selected, “A” appears.

12 CHANNEL NAME FIELD (p. 16)

- The channel name appears, if programmed.
- “DSC CHECK” blinks while receiving on channel 70.

13 KEY ICONS (p. 9)

Shows the programmed function of the softkeys on the front panel.

14 TIME ZONE INDICATOR

- Shows the current time when GPS data is received, or the time is manually programmed.
 - “??” will blink when invalid GPS data is received for 30 seconds.
 - “??” will blink when manually input GPS data is no longer valid after 4 hours, and then “NO TIME” will appear after 23.5 hours.
- “LOCAL” appears when the offset time is set.
- “NO TIME” appears when no GPS data is received and no time data is manually input.
- “MNL” appears when the time is manually programmed.

3 PANEL DESCRIPTION

■ Function Display (Continued)

15 POSITION INDICATOR





- Shows the current position when valid GPS data is received or the position is manually programmed.
 - “??” will blink when invalid GPS data is received for 30 seconds.
 - “??” will blink when manually input GPS data is no longer valid after 4 hours, and then “NO POSITION” will appear after 23.5 hours.
 - “NO POSITION” appears when no GPS data is received, and no position is manually input.

16 SCAN INDICATOR*

- “SCAN 16” is displayed during a Priority scan; “SCAN” appears during a Normal scan. (p. 18)
 - “DUAL 16” appears during Dualwatch; “TRI 16” appears during Tri-watch. (p. 20)
- * Except for the Dutch version.

17 BATTERY INDICATOR

Shows the battery’s remaining power.

Indication				
Battery level	Full	Middle	Charging required	No battery

 blinks when the battery is over charged.

■ Softkey function

Various functions can be assigned to the softkeys. When the key function is assigned, the key icon is displayed above the softkeys, as shown below.

◇ Softkey function selection

When “◀” or “▶” is displayed beside the key icon, pushing [◀] or [▶] sequentially displays the previous or next key function that is assigned to the softkey.

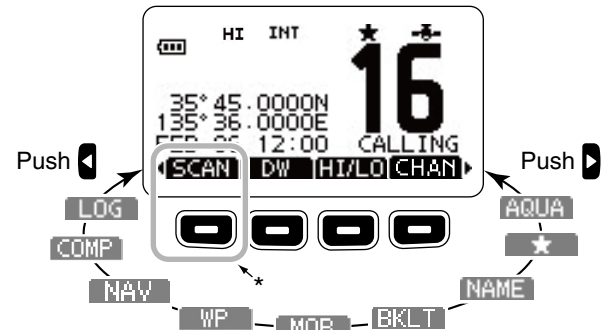

*Push this key to start or stop a scan.

 The order of the key icons may differ, depending on the preprogramming.

■ MMSI code programming

The 9 digit MMSI (Maritime Mobile Service Identity: DSC self ID) code can be programmed at power ON.

/// This initial code setting can be performed only once. After being set, it can be changed by only your dealer or distributor. If your MMSI code has already been programmed, this programming is not necessary.

- ① Hold down [⏻] to turn ON the power.
 - Three short beeps sound, and “NO DSC MMSI” is displayed.
- ② Push [ENTER] to start the MMSI code programming.
 - Push [CLEAR] twice to cancel the programming, and go to the normal operating screen. In this case, the transceiver cannot make a DSC call. To program the MMSI code, turn OFF the power, then turn it ON again.
- ③ Enter your MMSI code in the following manner:
 - Select a desired number using [▲]/[▼]/[◀]/[▶].
 - Push [ENTER] to set it.
 - To move the cursor, select either arrow, “←” or “→,” then push [ENTER].

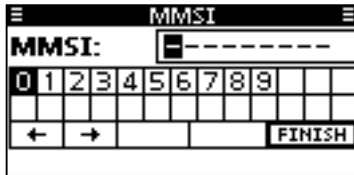

- ④ Repeat step ③ to enter all 9 digits.
- ⑤ After entering the 9 digit code, “FINISH” is automatically selected, and then push [ENTER] to set it.
- ⑥ The “MMSI CONFIRMATION” screen is displayed.

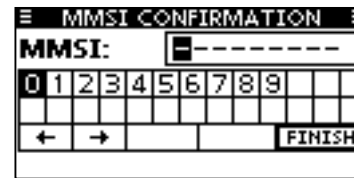

- ⑦ Enter your MMSI code again for confirmation.
 - Enter in the same manner as steps ③ through ⑤.
- ⑧ When your MMSI code programming is successfully completed, the screen as shown below is briefly displayed.
 - After that, the normal operating screen is displayed.



The programmed MMSI code can be checked in the MENU screen. (p. 77)

/// NOTE: Depending on the transceiver version, the ATIS code programming is required after programming the MMSI code. See the next page for details.

4 PREPARATION

■ ATIS code programming (For Dutch and German versions)

The 10 digit ATIS (Automatic Transmitter Identification System) code can be programmed at power ON.

This initial code setting can be performed only once. After being set, it can be changed by only your dealer or distributor. If your ATIS code has already been programmed, this programming is not necessary.

- ① After programming the MMSI code, “Push [ENTER] to Register Your ATIS” is displayed.
- ② Push [ENTER] to start the ATIS code programming.
 - Push [CLEAR] twice to cancel the programming, and go to the normal operating mode. In this case, the ATIS function is disabled. To program the ATIS code, turn OFF the power, then turn it ON again.
- ③ Enter your ATIS code in the following manner:
 - Select a desired number using [▲]/[▼]/[◀]/[▶].
 - Push [ENTER] to set it.
 - To move the cursor, select either arrow, “←” or “→,” then push [ENTER].

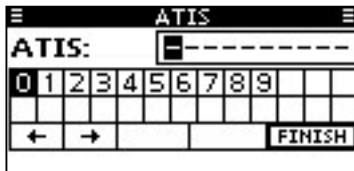

- ④ Repeat step ③ to enter all 10 digits.
- ⑤ After entering the 10 digit code, “FINISH” is automatically selected, and then push [ENTER] to set it.
- ⑥ The “ATIS CONFIRMATION” screen is displayed.

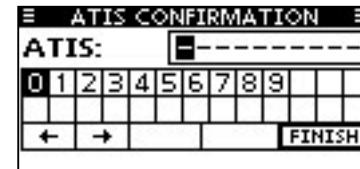

- ⑦ Enter your ATIS code again for confirmation.
 - Enter in the same manner as steps ③ through ⑤.
- ⑧ When your ATIS code programming is successfully completed, the screen as shown below is briefly displayed.
 - After that, the normal operating screen is displayed.



The programmed ATIS code can be checked in the MENU screen. (p. 77)

■ Channel selection

IMPORTANT: Prior to using the transceiver for the first time, the battery pack must be fully charged for optimum life and operation. To avoid damage to the transceiver, turn the power OFF while charging.

◇ Channel 16

Channel 16 is the distress and safety channel. It is used for establishing initial contact with a station and for emergency communications. Channel 16 is monitored during both Dual-watch and Tri-watch*. While in the standby condition, you must monitor Channel 16.

* Except for the Dutch version.

- ① Push [16/C] to select Channel 16.
- ② Push [CHAN] to return to the selected channel before Channel 16, or push [▲](CH) or [▼](CH) to select an operating channel.

Push [16/C] key

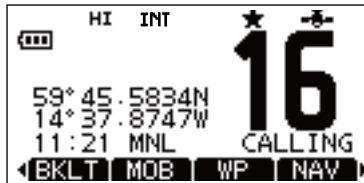

◇ Call channel

Each regular channel group has separate leisure-use call channels. The call channel is monitored during Tri-watch*. The call channels can be programmed and are used to store your most often used channel in each channel group for quick recall. (p. 13)

* Except for the Dutch version.

- ① Hold down [16/C] for 1 second to select Call channel.
 - "CALL" and the call channel number are displayed.
 - Call channel can be re-programmed. See the "Call channel programming" on page 13 for details.
- ② Push [CHAN] to return to the selected channel before the call channel, or push [▲](CH) or [▼](CH) to select the operating channel.

Hold down [16/C] key for 1 second

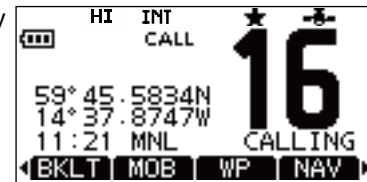

5 BASIC OPERATION

◇ Channel group selection

There are preprogrammed international channels for the IC-M91D. For U.K. transceiver version, there are preprogrammed U.S.A. channels in addition to International channels. For Dutch and German versions, there are preprogrammed ATIS and DSC* channels in addition to International channels.

Except for the Europe version, a channel group suitable for your operating area is selectable, as described below.

- ① Push [MENU].
- ② Push [▲]/[▼] to select "Radio Settings".
- ③ Push [▲]/[▼] to select "CHAN Group", and then push [ENTER].
- ④ Push [▲]/[▼] to select the desired channel group, and then push [ENTER].
- ⑤ Push [EXIT] to exit the Menu screen.
- ⑥ Push [▲](CH)/[▼](CH) to select a channel.
 - "DUP" appears for duplex channels.
 - "A" appears for simplex channel.

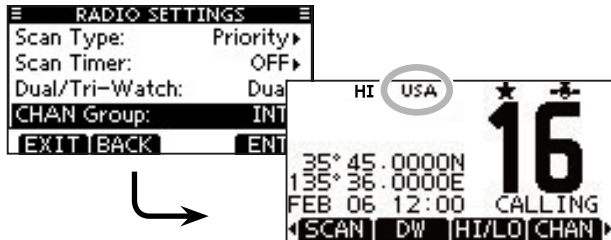

* German version only.

When the U.S.A. channel group is selected.

■ Call channel programming

You can program the call channel with your most often-used channels in each channel group for quick recall.

- ① Select the desired channel group to be programmed, as described to the left.
- ② Hold down [16/C] for 1 second to select the call channel of the selected channel group.
 - "CALL" and call channel number are displayed.
- ③ Hold down [16/C] again for 3 seconds until long beep stops with two short beeps.
 - The channel programming mode screen is displayed.
- ④ Push [▲](CH)/[▼](CH) to select the desired channel.
- ⑤ Push [ENTER] to program the selected channel as the call channel.
 - The display automatically returns to the normal operating mode.

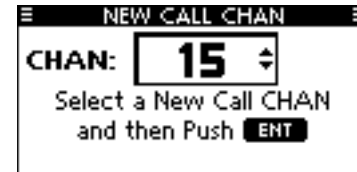

■ Adjusting the volume level

The volume level can be adjusted with [VOL/SQL] and [▲]/[▼]/[◀]/[▶] keys.

- ① Push [VOL/SQL] once to enter the volume adjustment mode, then adjust the volume level with [▲]/[▼] or [◀]/[▶].
 - The transceiver has 20 volume levels and OFF.
 - If no key operation is performed for 5 seconds, the transceiver sets the selected level, and returns to the normal mode.
- ② Push [ENTER] to set, and exit the volume adjustment mode.
 - Push [CLEAR] to cancel.

■ Adjusting the squelch level

The squelch level can be adjusted with [VOL/SQL] and [▲]/[▼]/[◀]/[▶] keys.

In order to receive signals properly, as well as for the scan to function effectively, the squelch must be adjusted to its proper level.

- ① Push [VOL/SQL] twice to enter the squelch adjustment mode, then adjust the squelch level with [▲]/[▼] or [◀]/[▶].
 - The transceiver has 11 squelch levels: OPEN is completely open, 10 is tight squelch and 1 is loose squelch.
 - If no key operation is performed for 5 seconds, the transceiver sets the selected level, and returns to the normal mode.
- ② Push [ENTER] to set, and exit the squelch adjustment mode.
 - Push [CLEAR] to cancel.

■ Receiving and transmitting

CAUTION: Transmitting without an antenna will damage the transceiver.

- ① Hold down [⏻] for 1 second to turn power ON.
- ② Set the volume and squelch levels with [VOL/SQL].
- ③ Push [▲](CH)/[▼](CH) to select the desired channel.
 - Further adjustment of the audio may be necessary at this point.
- ④ Select [HI/LO] to select the output power if necessary.
 - “HI” appears when high power is selected; “LOW” when low power is selected.
 - Choose low power for short range communications, choose high power for longer distance communications.
 - Some channels are for low power only.
- ⑤ Hold down [PTT] to transmit, then speak into the microphone.
 - “TX” appears.
 - Channel 70 cannot be used for transmission.
- ⑥ Release [PTT] to receive.

✓ Information

- The Noise Cancel function reduces random noise components in the transmit and/or receive signal. See page 80 for details
- The transceiver monitors channel 70 every specific time period even when standing by on an operating channel.
 - “DSC CHECK” is displayed when channel 70 is busy.
 - The channel 70 monitoring configuration can be changed in DSC Settings. See page 64 for details.

5 BASIC OPERATION

■ Receiving and transmitting (Continued)

IMPORTANT: To maximize the readability of your transmitted signal, pause a few seconds after pushing [PTT], hold the microphone 5 to 10 cm (2 to 4 inches) from your mouth and speak into the microphone at a normal voice level.

To prevent accidental prolonged transmission, the transceiver has a time-out timer function. This timer cuts a transmission OFF after 5 minutes of continuous transmission.

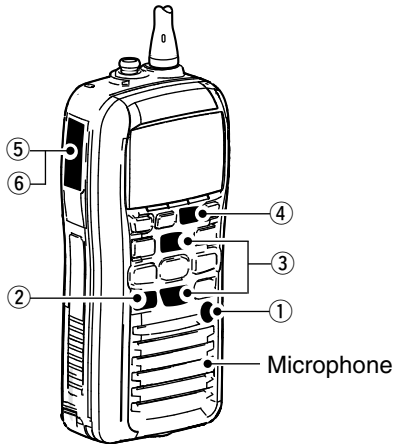

■ Lock function

This function electronically locks all keys (except for [PTT], [DISTRESS] and [↺]) to prevent accidental channel changes and function access.

➔ Push [CLEAR/↺] for 1 second to turn the lock function ON and OFF.

- The lock function is automatically released when DSC call is received, or [DISTRESS] is pushed.

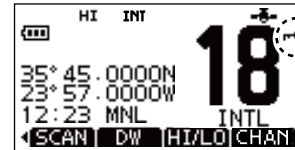

Displayed when the lock function is activated.

■ Monitor function

The Monitor function opens the squelch by holding down [VOL/SQL] for 1 second.

- “MONI” appears while the function is activated.

The function can be set to “PUSH” or “HOLD” in the following manner.

- ① Select “Configuration” in the “MENU” screen.
- ② Select “Monitor” to enter the “Push” or “Hold” selecting mode.
 - Push: The monitor function is activated by holding down [VOL/SQL] for 1 second. The squelch opens while holding down the key.
 - Hold: The monitor function is activated by holding down [VOL/SQL] for 1 second. The squelch stays open until any key is pushed.

■ AquaQuake water draining function

The AquaQuake water draining function clears water away from the speaker grill. Without this function, water may muffle the sound coming from the speaker. The transceiver emits a vibrating beep when this function is activated.

- While holding down [AQUA], the AquaQuake function is activated to clear water away from the speaker grill.
 - Beep sounds, regardless of the volume level setting.
 - Activates for 10 seconds in maximum to drain water.
 - The transceiver never accepts key operation while the AquaQuake function is activated.
 - The AquaQuake function can not be activated when an optional speaker-microphone is connected.

■ Backlight setting

This function lights the function display and keys, and it is convenient for night-time operation.

- ① Select [BKLT] to enter the backlight adjusting mode.
- ② Push [▲]/[▼] or [◀]/[▶] to adjust the brightness level between 1 (minimum) to 7 (maximum) or OFF.
 - The default setting is 4.
 - The display returns automatically to the main menu after 5 seconds without no key operation is been performed.
 - The backlight automatically turns OFF when no key operation is performed for 5 seconds.

■ Channel name programming

Each channel can be assigned a unique alphanumeric ID of up to 10 characters.

Capital letters, 0 to 9, some symbols (! " # \$ % & ' () * + , - . / [\] ^ _ : ; < = > ?) and space can be used.

- ① Push [▲](CH) or [▼](CH) to select a channel.
 - First, cancel the Dualwatch, Tri-watch* or Scan* function, if activated.
- ② Push [NAME] to open the channel name programming screen.
 - A black box is displayed on the first character.
- ③ Enter the desired channel name in the following manner:
 - Select a desired character using [▲]/[▼]/[◀]/[▶].
 - Push [ENTER].
 - To move the cursor, select either arrow, “←” or “→,” then push [ENTER].
 - Select “SPACE,” then push [ENTER] to input a space.
 - Select “DELETE,” then push [ENTER] to delete a character.
 - Push [CLEAR] to cancel and return to the previous screen.



* Except for the Dutch version

5 BASIC OPERATION

- Channel name programming
- ④ Repeat step ③ to input all characters.



- ⑤ Push [◀]/[▶]/[▲]/[▼] to select “FINISH,” then push [ENTER] to set and return to the previous screen.



■ Scan types

Scanning is an efficient way to locate signals quickly over a wide frequency range. The transceiver has a Priority scan and a Normal scan.

PRIORITY SCAN

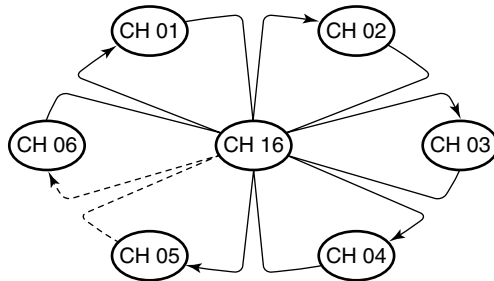

The Priority scan sequentially searches through all Favorite channels while monitoring Channel 16. When a signal is detected on Channel 16, the scan pauses until the signal disappears. When a signal is detected on a channel other than Channel 16, the scan becomes a Dualwatch until the signal disappears.

Set the Favorite channels (scanned channel) before scanning. Clear the Favorite channels which inconveniently stop scanning, such as those for digital communication use. (Refer to the next page for details.)

/// Choose Priority or Normal scan in the Menu screen. (p. 78)

NORMAL SCAN

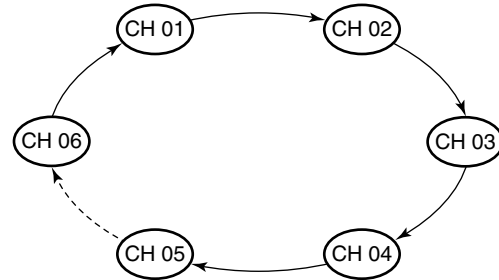

The Normal scan, like the Priority scan, sequentially searches through all Favorite channels. However, unlike the Priority scan, Channel 16 is not checked unless it is set as a Favorite channel.

6 SCAN OPERATION (Except for the Dutch version)

■ Setting Favorite channels

For more efficient scanning, add the desired channels as Favorite channels, or clear “★” for unwanted channels.

Channels that are not tagged will be skipped while scanning. Favorite channels can be independently assigned to each channel group (INT, USA, ATIS or DSC).

- ① Select the desired channel group. (p. 13)
- ② Select the desired channel to be set as a Favorite channel.
- ③ Push [★] to set the displayed channel as a Favorite channel.
 - “★” appears on the display.
- ④ To cancel the Favorite channel setting, repeat step ③.
 - “★” disappears.

✓ Clearing (or setting) all tagged channels

Hold down [★] for 3 seconds (until a long beep changes to 2 short beeps) to clear all Favorite channel settings in the selected channel group.

- Repeat above procedure to set all channels as Favorite channels.

■ Starting a scan

First, set the scan type (Priority or Normal scan) and scan resume timer in the Menu screen. (p. 78)

- ① Select the desired channel group. (p. 13)
- ② Set the Favorite channels, as described to the left.
- ③ Make sure the squelch is closed to start a scan.
- ④ Push [SCAN] to start a Priority or Normal scan.
 - “SCAN 16” appears during a Priority scan; “SCAN” appears during a Normal scan.
 - When a signal is detected, the scan pauses until the signal disappears, or resumes after pausing 5 seconds, depending on the setting. (Channel 16 is still monitored during a Priority scan.)
 - Push [▲]/[▼] check the scanning Favorite channels, change the scanning direction or manually resume the scan.
 - A beep tone sounds and “16” blinks when a signal is received on Channel 16 during a Priority scan.
- ⑤ To stop the scan, push [CLEAR] or repeat step ④.

[Example]: Starting a Normal scan.

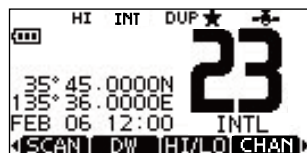

Push
[SCAN]

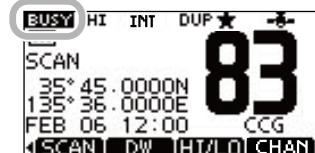
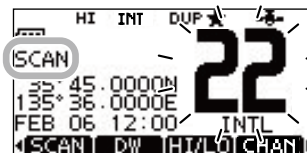

Description

Dualwatch monitors Channel 16 while you are receiving on another channel; Tri-watch* monitors Channel 16 and the call channel while receiving another channel. Dualwatch/Tri-watch* is convenient for monitoring Channel 16 when you are operating on another channel.

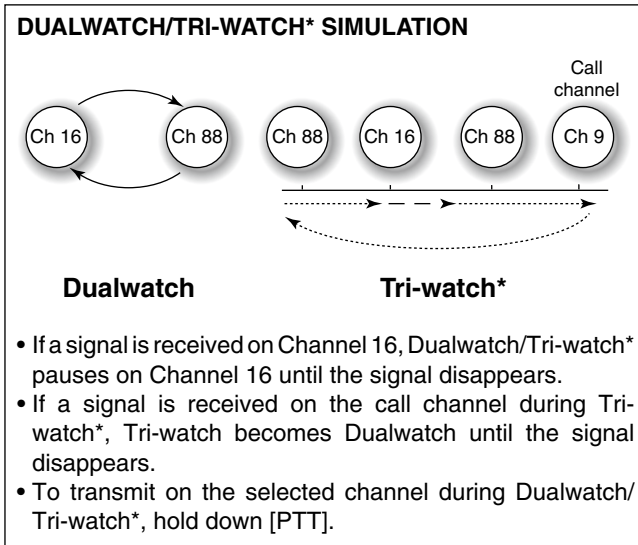

Operation

- ① Select Dualwatch or Tri-watch* in the Menu screen. (p. 78)
- ② Push [▲](CH) or [▼](CH) to select the desired operating channel.
- ③ Push [DW] to start a Dualwatch or Tri-watch* scan.
 - “DUAL 16” appears during Dualwatch; “TRI 16” appears during Tri-watch*.
 - A beep tone sounds when a signal is received on Channel 16.
- ④ To cancel Dualwatch or Tri-watch*, push [DW] again.

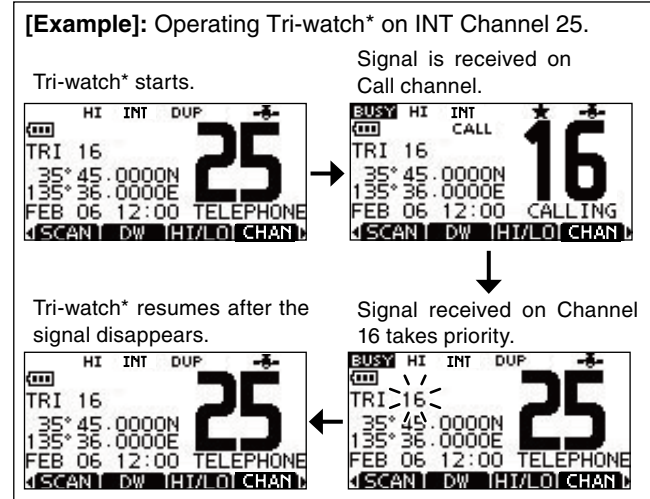

* Available except for the Dutch version.

■ DSC address ID

◇ Programming Individual ID

A total of 100 DSC address IDs can be programmed and assigned a name of up to 10 characters.

- ① Enter "INDIVIDUAL ID" in the DSC SETTINGS menu.

◀MENU▶ ⇄ ▶DSC Settings▶ ⇄ ▶Individual ID▶
(Push [MENU]) (Push [▲]/[▼], then push [ENTER].)

- ② Push [ADD].

• The "INDIVIDUAL ID" program screen is displayed.

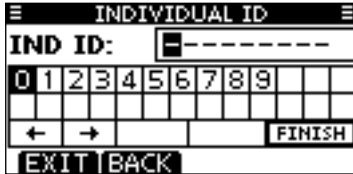

- ③ Enter a desired individual ID in the following way:

- Select a desired number using [◀]/[▶].
- Push [ENTER] to set it.
- To move the cursor, select either arrow, "←" or "→," then push [ENTER].

▨ The first digit is specified as '0' for a Group ID.

▨ The first two digits are '0' for any Coast station ID.

- ④ Repeat step ③ to enter all 9 digits.

- ⑤ After entering the 9 digit code, push [ENTER] to set it.
• The ID name programming screen is displayed.



- ⑥ Enter a desired 10 digit ID name in the following way:

- Select a desired character using [▲]/[▼]/[◀]/[▶].
- Push [ENTER] to set it.
- To move the cursor, select either arrow, "←" or "→," then push [ENTER].
- Push [123] then [!\$?] then [ABC] to select a character group.

- ⑦ After entering the ID name, push [▲]/[▼]/[◀]/[▶] to select "FINISH," then push [ENTER] to program it.
• The "INDIVIDUAL ID" list screen is displayed.



- ⑧ Push [MENU] to exit the MENU screen.

◇ Programming Group ID

- Enter "GROUP ID" in the DSC SETTINGS menu.

<MENU> ⇄ <DSC Settings> ⇄ <Group ID>
 (Push [MENU]) (Push [▲]/[▼], then push [ENTER].)

- Push [ADD].
 - The "GROUP ID" program screen is displayed.



- Enter a desired group ID in the following way:
 - Select a desired number using [◀]/[▶].
 - Push [ENTER] to set it.
 - To move the cursor, select either arrow, "←" or "→," then push [ENTER].

- ▨ The first digit is fixed as '0' for a Group ID.
- ▨ The first two digits are '0' for any Coast station ID.

- Repeat step ③ to input the specific 9 digits group code.

- After entering the 9 digit code, push [ENTER] to set it.
 - The Group ID name programming screen is displayed.



- Enter a desired 10 digit ID name in the following way:
 - Select a desired character using [▲]/[▼]/[◀]/[▶].
 - Push [ENTER] to set it.
 - To move the cursor, select either arrow, "←" or "→," then push [ENTER].
 - Push [123], [!\$?] or [ABC] to select a character group.
- After entering the ID name, push [▲]/[▼]/[◀]/[▶] to select "FINISH," then push [ENTER] to program it.
 - The "GROUP ID" list screen is displayed.



- Push [MENU] to exit the MENU screen.

8 DSC OPERATION

◇ Deleting Individual/Group ID

- ① Enter "INDIVIDUAL ID" or "GROUP ID" in the DSC SETTINGS menu.

◀MENU▶ ⇄ ▶DSC Settings◀ ⇄ ▶Individual ID◀/▶Group ID◀
(Push [MENU]) (Push [▲]/[▼], then push [ENTER].)

• When no address ID is programmed, "No ID" is displayed. In this case, push [MENU] to exit the MENU screen.

- ② Push [▲]/[▼] to select a desired ID name, then push [DEL].



- ③ Push [OK] to delete the ID, and return to the "INDIVIDUAL ID" or "GROUP ID" list screen.
 - Push [CANCEL] to cancel it.



- ④ Push [MENU] to exit the MENU screen.

■ Position and time programming

A Distress call should include the ship's position and time. If no GPS data is received, your position and UTC (Universal Time Coordinated) time should be manually input.

- Manual programming is disabled while GPS data is received.
- Manually programmed position and time will be held for only 23.5 hours.

- ① Enter "POSITION INPUT" in the DSC SETTINGS menu.

◀MENU▶ ⇄ ▶DSC Settings▶ ⇄ ▶Position Input▶
 (Push [MENU]) (Push [▲]/[▼], then push [ENTER].)

- ② Edit your latitude and longitude position using [▲]/[▼]/[◀]/[▶].
 - Select a desired number using [◀]/[▶].
 - Push [ENTER] to set it.
 - To move the cursor, select either arrow, "←" or "→," then push [ENTER].
 - Select N (North latitude) or S (South latitude) when the cursor is on the 'N' or 'S' position.
 - Select W (West longitude) or E (East longitude) when the cursor is on the 'W' or 'E' position.

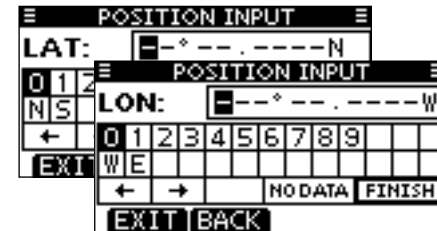

- ③ After entering the position, push [ENTER] to program it.
- ④ The UTC time programming screen is displayed, enter the UTC time in the following way:
 - Select a desired number using [◀]/[▶].
 - Push [ENTER] to set it.
 - To move the cursor, select either arrow, "←" or "→," then push [ENTER].

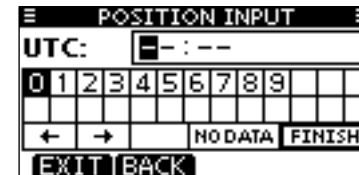

- ⑤ Push [ENTER] to program your position and time.
 - Return to the "DSC SETTINGS" screen.

■ Distress call

A Distress call should be transmitted if, in the opinion of the Master, the ship or a person is in distress and requires immediate assistance.

NEVER MAKE A DISTRESS CALL IF YOUR SHIP OR A PERSON IS NOT IN AN EMERGENCY. A DISTRESS CALL SHOULD BE MADE ONLY WHEN IMMEDIATE HELP IS NEEDED.

◇ Simple call

- ① Confirm no Distress call is being received.
- ② While lifting up the key cover on the back side of the transceiver, hold down [DISTRESS] for 3 seconds to transmit the Distress call.
 - While holding down [DISTRESS], count down beeps sound and both the key and display backlighting blink.
 - DSC channel (Channel 70) is automatically selected and the Distress call is transmitted.

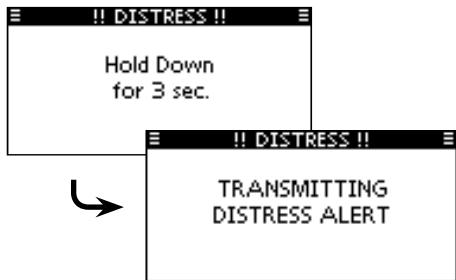

NOTE: The distress call is paused for up to 15 seconds when no valid position data is received. The distress call is made when a valid position data is received within 15 seconds.

- If valid position data cannot be received within 15 seconds, the distress call is made with a stored position data.
- ③ After the call, the transceiver waits for an acknowledgment call on channel 70 for 10 seconds, and then waits for a call by alternately monitoring channel 70 and channel 16.
 - The Distress call is automatically transmitted every 3.5 to 4.5 minutes, until an acknowledgement is received ('Call repeat' mode), or DSC Cancel call is made. (p. 28)
 - Push [RESEND] to manually transmit the Distress repeat call.
 - Push [◀]/[▶] then push [INFO] to display the transmitted Distress call information.
 - Push [◀]/[▶] then push [PAUSE] to pause the 'Call repeat' mode, push [RESUME] to resume it.



- ④ After receiving the acknowledgment, push [ALARM OFF] then reply using the microphone.
 - ➔ A distress alert default contains:
 - Nature of distress : Undesignated distress
 - Position information : The latest GPS or manual input position is held for 23.5 hours, or until the power is turned OFF.

◇ Regular call

The nature of the Distress call should be included in the Distress call.

- ① Enter "DISTRESS CALL" in the DSC CALLS menu.

⟨MENU⟩ ⇄ ⟨DSC Calls⟩ ⇄ ⟨Distress Call⟩
(Push [MENU]) (Push [▲]/[▼], then push [ENTER].)

- ② Select the nature of the distress using [▲]/[▼], then push [ENTER].

- 'Undesignated,' 'Fire,Explosion,' 'Flooding,' 'Collision,' 'Grounding,' 'Capsizing,' 'Sinking,' 'Adrift,' 'Abandoning Ship,' 'Piracy' or 'Man Overboard' is selectable.
- The nature of the distress is stored for 10 minutes after a selection is made.

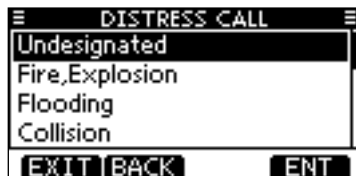

- ③ The Distress call confirmation screen is displayed.

- Push [▲]/[▼] to see the hidden lines.

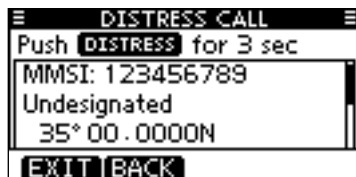

- ④ While lifting up the key cover on the back side of the transceiver, hold down [DISTRESS] for 3 seconds to transmit the Distress call.

- While holding down [DISTRESS], count down beeps sound and both the key and display backlighting blink.
- The selected nature of the distress is stored for 10 minutes.

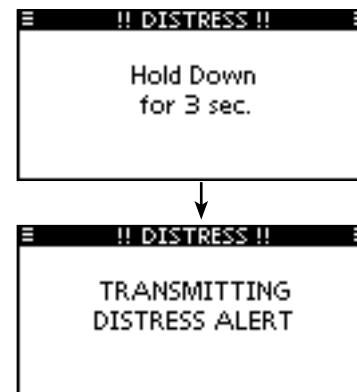

8 DSC OPERATION

⑤ After transmitting the call, the transceiver waits for an acknowledgment call.

- The Distress call is automatically transmitted every 3.5 to 4.5 minutes, until an acknowledgement is received ('Call repeat' mode), or DSC cancel call is made. (p. 28)
- Push [RESEND] to manually transmit the Distress repeat call.
- Push [◀]/[▶] then push [INFO] to display the transmitted Distress call information.
- Push [◀]/[▶] then push [PAUSE] to pause the 'Call repeat' mode, push [RESUME] to resume it.

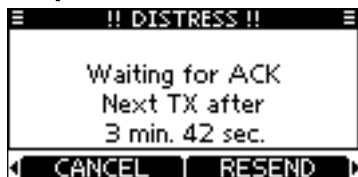

⑥ After receiving an acknowledgment call, push [ALARM OFF] then reply using the microphone.



➤ A distress alert contains:

- Nature of distress : Selected in step ②.
- Position information : The latest GPS or manual input position is held for 23.5 hours, or until the power is turned OFF.

When no GPS data is received or invalid data is received, and both position and time have been manually programmed, the screen as shown below appears. Edit your latitude and longitude position and UTC time as follows:



➤ Push [CHG], then edit your latitude and longitude position and UTC time.

- Select a desired number using [◀]/[▶].
- Push [ENTER] to set it.
- To move the cursor, select either arrow, "←" or "→," then push [ENTER].
- Select N (North latitude) or S (South latitude) when the cursor is on the 'N' or 'S' position.
- Select W (West longitude) or E (East longitude) when the cursor is on the 'W' or 'E' position.



◇ Distress cancel call

- ① While waiting for an acknowledgment call, push [CANCEL].

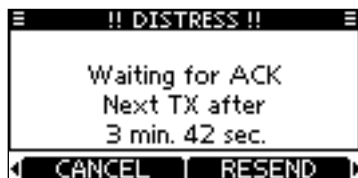

- ② Push [CONTINUE].
- Push [BACK] to return to waiting for an acknowledgement call.



- ③ Push [FINISH].
- Push [EXIT] to return to waiting for an acknowledgement call.



- ④ The Distress cancel call is transmitted.

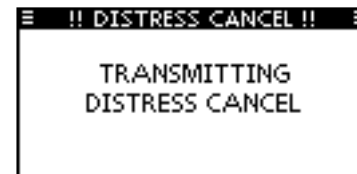

- ⑤ Channel 16 is automatically selected.
- Report your situation using the microphone.
 - After the report, push [EXIT] to return to the normal operating mode.

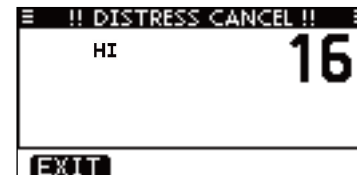

■ Transmitting DSC calls

▨ To ensure correct operation of the DSC function, make sure you correctly set the CH70 SQL LEVEL. (p. 63)

◇ Transmitting an individual call

The Individual call function allows you to transmit a DSC signal to only a specific station.

- ① Enter "INDIVIDUAL CALL" in the DSC CALLS menu.

◀MENU▶ ⇄ ▶DSC Calls▶ ⇄ ▶Individual Call▶
(Push [MENU]) (Push [▲]/[▼], then push [ENTER].)

- ② Select the desired preprogrammed individual address, or "Manual Input," using [▲]/[▼], then push [ENTER].
 - The ID code for the Individual call can be set first. (p. 21)
 - When "Manual Input" is selected, set a desired 9 digit MMSI ID code for the individual you wish to call.

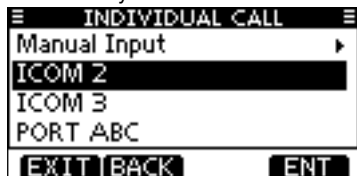

▨ About Manual Inputting:

Enter a desired individual ID in the following way:

- Select a desired number using [▲]/[▼]/[◀]/[▶].
- Push [ENTER] to set it.
- To move the cursor, select either arrow, "←" or "→," then push [ENTER].
- The first digit is specified as '0' for a Group ID. If a Group ID is entered, an error beep sounds after pushing [FINISH].
- The first two digits are '0' for any coast station ID.

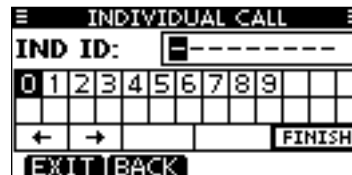

- ③ Select Routine, Safety or Urgency as the desired call type using [▲]/[▼], then push [ENTER].



▨ **NOTE:** When a coast station is selected in step ②, the voice channel is automatically specified by the coast station. Therefore, skip step ④ and go directly to step ⑤.

- ④ Select a desired intership channel using [▲](CH)/[▼](CH), then push [ENTER].
- Intership channels are already preset into the transceiver in the recommended order.

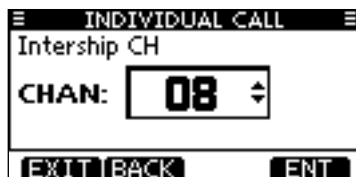

- ⑤ A confirmation screen appears.
- Confirm the call contents.

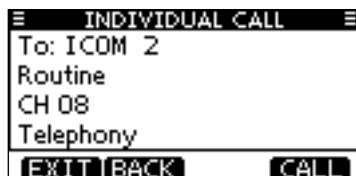

- ⑥ Push [CALL] to transmit the Individual call.
- If Channel 70 is busy, the transceiver stands by until the channel becomes clear.

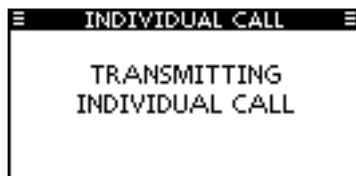

- ⑦ Standby on Channel 70 until an acknowledgement is received.

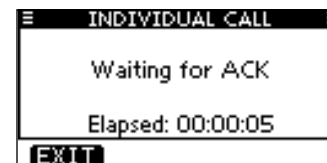

- The transceiver waits on channel 70 for 10 seconds, then alternately monitors channel 70 and the operating channel.
- ⑧ When the acknowledgement 'Able to comply' is received, beeps sound and the screen below is displayed.



- Push [ALARM OFF] to stop the beeps and then select the intership channel specified in step ④.
- A different intership channel will be selected if the station you called cannot use the channel.
 - Reply using the microphone. And go to step ⑨.

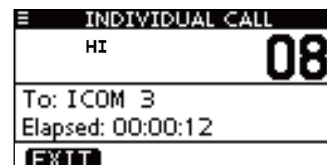

8 DSC OPERATION

Or, when the acknowledgement 'Unable to comply' is received, beeps sound and the screen below is displayed.



Push [ALARM OFF] to stop the beeps. Then push [EXIT] to return to the operating channel (before you entered the MENU screen).

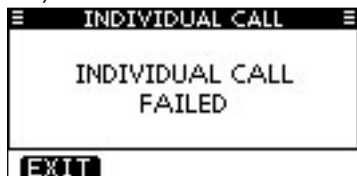

- ⑨ After communicating, push [EXIT] to return to the normal operating mode.

◇ Transmitting an Individual Acknowledgement

When receiving an Individual call, you can transmit an acknowledgement ('Able to Comply,' 'Propose New Channel' or 'Unable to Comply') by using the on-screen prompts (Quick ACK). Also, you can send an acknowledgement through the MENU system (Manual ACK.)

Quick ACK:

- ① When an Individual call is received, beeps sound and the screen below is displayed.

Push [ALARM OFF] to stop the beeps.



- ② Push [ACK].

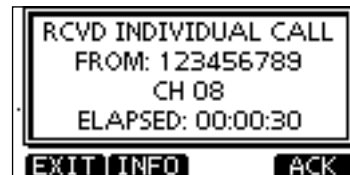

③ Select one of three options, then push [ENTER].



- Able to Comply : Make an acknowledgment call without any changes.
- Unable to Comply : You cannot make a communication. The Acknowledgement call ('Unable to Comply') can be automatically transmitted, if set. See page 61 for details.
- Propose New Channel : You can make an acknowledgement call, but you specify the intership channel. Select a desired intership channel, using [▲](CH)/[▼](CH), then push [ENTER].

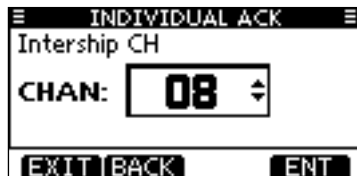

④ The Individual ACK confirmation screen is displayed. Push [CALL] to transmit an acknowledgement call.

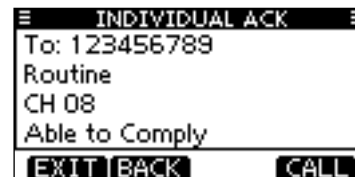

⑤ The screens shown below are displayed.

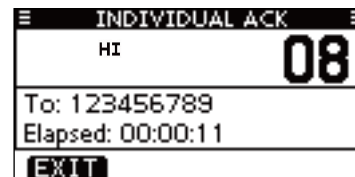
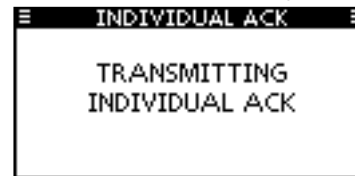

- ⑥ Reply to the call using the microphone.
- ⑦ Push [EXIT] to return to the normal operating mode.

8 DSC OPERATION

Manual ACK:

- ① Enter "INDIVIDUAL ACK" in the DSC CALLS menu.

⟨MENU⟩ ⇨ ⟨DSC Calls⟩ ⇨ ⟨Individual ACK⟩
(Push [MENU]) (Push [▲]/[▼], then push [ENTER].)

- When no Individual call has been received, "Individual ACK" item will not be displayed.



- ② Select a desired individual address or ID code to reply to, using [▲]/[▼], then push [ENTER].



- ③ Perform steps ③ to ⑦, as described in "Quick ACK:," beginning on the previous page.

◇ Transmitting a Group call

The Group call function allows you to transmit a DSC signal to only a specific group.

- ① Enter "GROUP CALL" in the DSC CALLS menu.

⟨MENU⟩ ⇨ ⟨DSC Calls⟩ ⇨ ⟨Group Call⟩
(Push [MENU]) (Push [▲]/[▼], then push [ENTER].)

- ② Select the desired preprogrammed group address or "Manual Input," using [▲]/[▼], then push [ENTER].
 - The ID code for the Group call can be set first. (p. 22)
 - When "Manual Input" is selected, set the 8 digit ID code for the group you wish to call.



- ③ Select a desired intership channel using [▲](CH)/[▼](CH), then push [ENTER].
 - Intership channels are already preset into the transceiver in the recommended order.



About Manual Inputting:

Enter a desired group ID in the following way:

- Select a desired number using [◀]/[▶].
- Push [ENTER] to set it.
- To move the cursor, select either arrow, “←” or “→,” then push [ENTER].
- The first digit is specified as ‘0’ for a Group ID.
- The first two digits are ‘0’ for any Coast station ID.



- ④ A confirmation screen appears.
- Confirm the call contents.



- ⑤ Push [CALL] to transmit the Group call.
- If Channel 70 is busy, the transceiver stands by until the channel becomes clear.



- ⑥ After the Group call has been transmitted, the following screen is displayed.



- ⑦ Announce the information using the microphone.
- ⑧ After the announcement, push [EXIT] to return to the normal operating mode.

8 DSC OPERATION

◇ Transmitting an All Ships call

All ships, that have DSC transceiver, use Channel 70 as their 'listening channel.' When you want to announce a message to these ships within range, use the 'All Ships Call' function.

- ① Enter "ALL SHIPS CALL" in the DSC CALLS menu.

◀MENU> ⇄ <DSC Calls> ⇄ <All Ships Call>
(Push [MENU]) (Push [▲]/[▼], then push [ENTER].)

- ② Select a desired category, using [▲]/[▼], then push [ENTER].

- The selectable category may differ, depending on the programmed setting. Ask your dealer for the selectable categories.

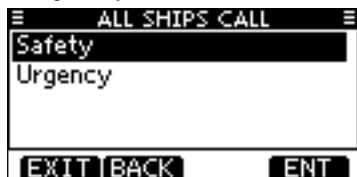

- ③ Select a desired traffic channel, using [▲]/[▼], then push [ENTER].

- The selected channel is displayed.



- ④ A confirmation screen appears.

- Confirm the call contents.

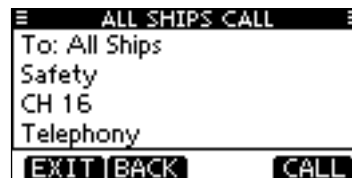

- ⑤ Push [CALL] to transmit the All Ships call.

- If Channel 70 is busy, the transceiver stands by until the channel becomes clear.



- ⑥ After the All Ships call has been transmitted, the following screen is displayed.

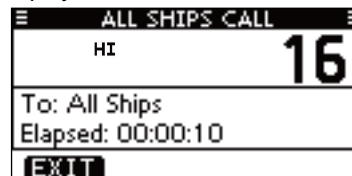

- ⑦ Announce the message using the microphone.

- ⑧ After the announcement, push [EXIT] to return to the normal operating mode.

◇ Transmitting a Test call

Testing on the exclusive DSC distress and safety calling channels should be avoided as much as possible. When testing on a distress/safety channel is unavoidable, you should indicate that these are test transmissions.

Normally the test call would require no further communications between the two stations involved.

- 1 Enter "TEST CALL" in the DSC CALLS menu.

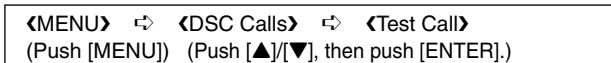

- 2 Select a desired preprogrammed individual address, or "Manual Input," then push [ENTER].
 - The ID code for the Individual call can be set first. (p. 21)
 - When "Manual Input" is selected, set the 9 digit MMSI ID code for the individual you wish to call.

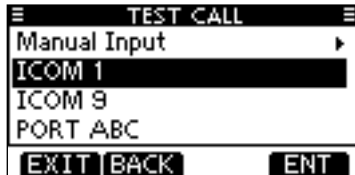

About Manual Inputting:

Enter a desired address ID in the following way:

- Select a desired number using [◀]/[▶].
- Push [ENTER] to set it.
- To move the cursor, select either arrow, "←" or "→," then push [ENTER].
- The first digit is specified as '0' for a Group ID. If a Group ID is entered, an error beep sounds after pushing [FINISH].
- The first two digits are '0' for any Coast station ID.



- 3 A confirmation screen appears.
 - Confirm the call contents.



8 DSC OPERATION

- ④ Push [CALL] to transmit the Test call.
- If Channel 70 is busy, the transceiver stands by until the channel becomes clear.



- ⑤ After the Test call has been transmitted, the following screen is displayed.

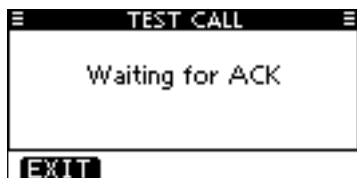

- The transceiver waits for an acknowledgment call on channel 70 for 10 seconds, then waits for a call by alternately monitoring channel 70 and the operating channel.

- ⑥ When the acknowledgement call is received, beeps sound and the following screen is displayed.



- ⑦ Push [ALARM OFF] to stop the beeps, and then the screen as shown below is displayed.



- ⑧ Push [EXIT] to return to the normal operating mode.

◇ Transmitting a Test Acknowledgement call

When the "TEST ACK" in DSC settings is set to 'Auto TX' (p. 61), the transceiver automatically transmits a reply call when receiving a Test call.

Quick ACK:

- ① When a Test call is received, beeps sound and the screen shown below is displayed.
Push [ALARM OFF] to stop the beeps.



- ② Push [ACK].

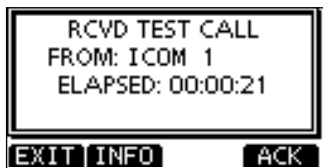

- Push [INFO] to display the Test call information.
Push [BACK] to return to the previous screen, or push [ACK].



- ③ The Test ACK confirmation screen is displayed.
Push [CALL] to transmit the acknowledgement call.



- ④ While transmitting the acknowledgement call, the screen shown below is displayed, and then returns to the normal operating mode.



8 DSC OPERATION

Manual ACK:

- ① Enter "TEST ACK" in the DSC CALLS menu.

◀MENU▶ ⇄ ◀DSC Calls▶ ⇄ ◀Test ACK▶
(Push [MENU]) (Push [▲]/[▼], then push [ENTER].)

- If no Test call has been received, the "TEST ACK" item will not be displayed.

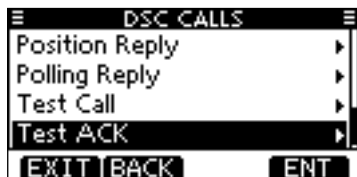

- ② Select a desired Test call to reply to, using [▲]/[▼], then push [ENTER].

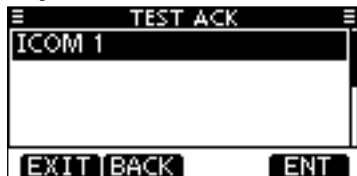

- ③ The Test ACK confirmation screen is displayed. Push [CALL] to transmit the acknowledgement call.



- ④ While transmitting the acknowledgement call, the screen shown below is displayed, and then returns to the normal operating mode.



◇ Transmitting a Position Reply call

Transmit a Position Reply call when a Position Request call is received.

When the “POSITION ACK” in DSC Settings is set to ‘Auto TX’ (p. 61), the transceiver automatically transmits a reply call when receiving a Position Request call.

Quick Reply:

- ① When a Position Request call is received, beeps sound and the screen shown below is displayed.
Push [ALARM OFF] to stop the beeps.



- ② Push [ACK].



- Push [INFO] to display the Position Request call information.
Push [BACK] to return to the previous screen, or push [ACK].



- ③ The Position Reply confirmation screen is displayed.
Push [CALL] to transmit the reply call.

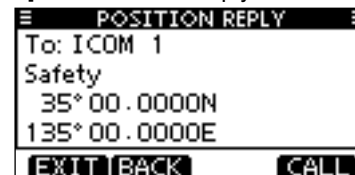

- ④ While transmitting the reply call, the screen shown below is displayed, and then returns to the normal operating mode.



8 DSC OPERATION

Manual Reply:

- ① Enter "POSITION REPLY" in the DSC CALLS menu.

◀MENU▶ ⇄ ◀DSC Calls▶ ⇄ ◀Position Reply▶
(Push [MENU]) (Push [▲]/[▼], then push [ENTER].)

- If no Position Request call has been received, the "POSITION REPLY" item will not be displayed.



- ② Select a desired Position Request call to reply to, using [▲]/[▼], then push [ENTER].



- ③ The Position Reply call confirmation screen is displayed. Push [CALL] to transmit the acknowledgement call.

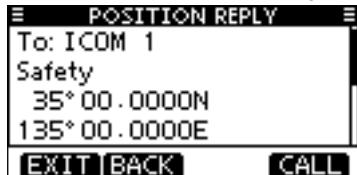

- ④ While transmitting the reply call, the screen shown below is displayed, and then returns to the normal operating mode.



When no GPS data is received or invalid data is received, and both position and time have been manually programmed, the screen shown below appears. Edit your latitude and longitude position and UTC time as follows:



- Push [CHG], then edit your latitude and longitude position and UTC time.
 - Select a desired number using [◀]/[▶].
 - Push [ENTER] to set it.
 - To move the cursor, select either arrow, "←" or "→," then push [ENTER].
 - Select N (North latitude) or S (South latitude) when the cursor is on the 'N' or 'S' position.
 - Select W (West longitude) or E (East longitude) when the cursor is on the 'W' or 'E' position.

◇ Transmitting a Position Report Reply call

Transmit a Position Report Reply call when a Position Report Request call is received.

Quick Reply:

- ① When a Position Report Request call is received, beeps sound and the screen as shown below is displayed.
Push [ALARM OFF] to stop the beeps.



- ② Push [ACK].



- Push [INFO] to display the Position Report Request call information.
Push [BACK] to return to the previous screen, or push [ACK].

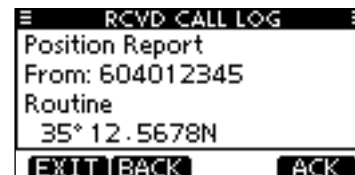

- ③ The Position Report Reply confirmation screen is displayed.
Push [CALL] to transmit the reply call.



- ④ While transmitting the reply call, the screen shown below is displayed, and then returns to the normal operating mode.



8 DSC OPERATION

Manual Reply:

- ① Enter "POSITION REPORT REPLY" in the DSC CALLS menu.

◀MENU> ⇄ ◀DSC Calls> ⇄ ◀Position Report Reply>
(Push [MENU]) (Push [▲]/[▼], then push [ENTER].)

- If no Position Report Request call has been received, the "POSITION REPORT REPLY" item will not be displayed.



- ② Select a desired Position Report Request call to reply to, using [▲]/[▼], then push [ENTER].



- ③ The Position Report Reply call confirmation screen is displayed.

Push [CALL] to transmit the acknowledgement call.



- ④ While transmitting the reply call, the screen shown below is displayed, and then returns to the normal operating mode.



◇ Transmitting a Polling Reply call

Transmit a Polling Reply call when a Polling Request call is received.

When the “POSITION ACK” in DSC Settings is set to ‘Auto TX’ (p. 61), the transceiver automatically transmits a reply call when receiving a Polling Request call.

Quick Reply:

- ① When a Polling Request call is received, beeps sound and the screen as shown below is displayed.
Push [ALARM OFF] to stop the beeps.

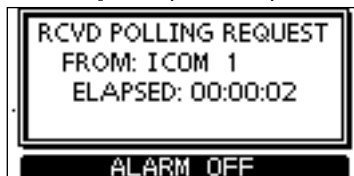

- ② Push [ACK].

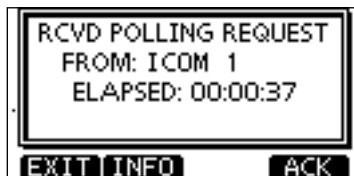

- Push [INFO] to display the Polling Request call information.
Push [BACK] to return to the previous screen, or push [ACK].



- ③ The Polling Reply confirmation screen is displayed.
Push [CALL] to transmit the reply call.

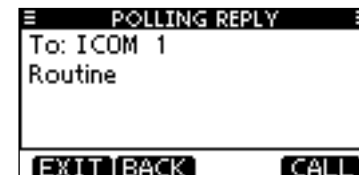

- ④ While transmitting the reply call, the screen shown below is displayed, and then returns to the normal operating mode.

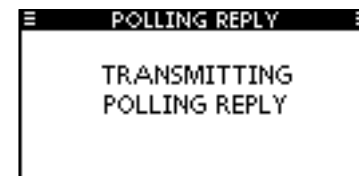

8 DSC OPERATION

Manual Reply:

- ① Enter "POLLING REPLY" in the DSC CALLS menu.

◀MENU> ⇄ ◀DSC Calls> ⇄ ◀Polling Reply>
(Push [MENU]) (Push [▲]/[▼], then push [ENTER].)

- If no Polling Request call has been received, the "POLLING REPLY" item will not be displayed.

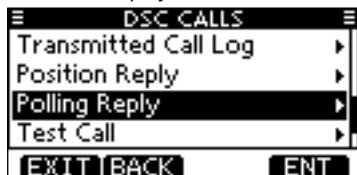

- ② Select a desired Polling Request call to be replied, using [▲]/[▼], then push [ENTER].

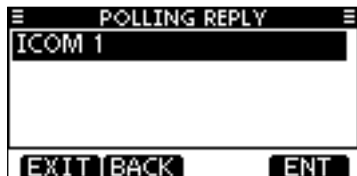

- ③ The Polling Reply call confirmation screen is displayed. Push [CALL] to transmit the acknowledgement call.

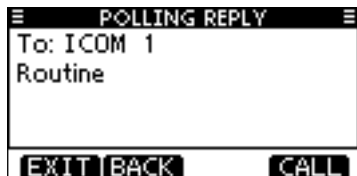

- ④ While transmitting the reply call, the screen shown below is displayed, and then returns to the normal operating mode.



■ Receiving DSC calls

◇ Receiving a Distress Call

When a Distress Call is received:

- ➔ The emergency alarm sounds for 2 minutes.
- ➔ “RCVD DISTRESS” pops up and the LCD backlight blinks.

- ① Push [ALARM OFF] to stop the alarm and the blinking backlight.



- ② Push a softkey to select your desired action.

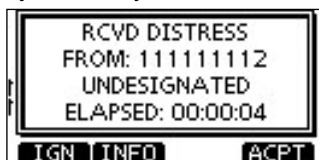

[IGN]

- ➔ Push to return to the normal operating mode.
 - The transceiver exits the DSC mode.
 - By pushing [PTT], the transceiver also exits the DSC mode.
 - “” continues to blink and the Call is stored in the Received Call Log.

[INFO]

- ➔ Push to display the Received call information. (p. 58)

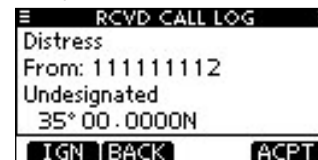

[ACPT]

- ➔ Push to accept the call.
 - And then, push [CH 16] to switch the operating channel to Channel 16, and then monitor it, as a coast station may require assistance.
 - If you haven't pushed [CH 16] within 10 seconds, the operating channel automatically switches to Channel 16. (p. 62)

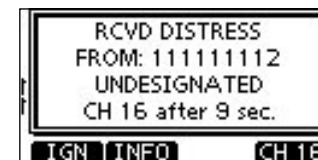

↓ Push

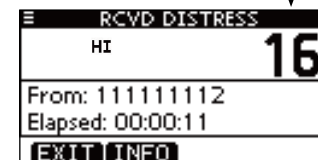

8 DSC OPERATION

◇ Receiving a Distress Acknowledgement

When a Distress Acknowledgement sent to another ship is received:

- The emergency alarm sounds for 2 minutes.
- “RCVD DISTRESS ACK” pops up and the LCD backlight blinks.

- ① Push [ALARM OFF] to stop the alarm and the blinking backlight.



- ② Push a softkey to select your desired action.

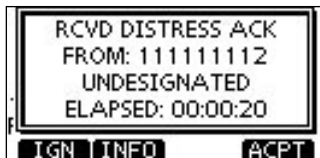

[IGN]

- Push to return to the normal operating mode.
 - The transceiver exits the DSC mode.
 - By pushing [PTT], the transceiver also exits the DSC mode.
 - “✉” continues to blink and the Call is stored in the Received Call Log.

[INFO]

- Push to display the Received call information. (p. 58)



[ACPT]

- Push to accept the call.
And then, push [CH 16] to switch the operating channel to Channel 16, and then monitor it, as a coast station may require assistance.
 - If you haven't pushed [CH 16] within 10 seconds, the operating channel automatically switches to Channel 16. (p. 62)



↓ Push

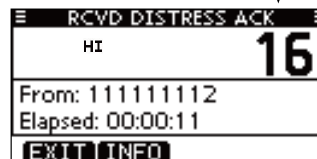

◇ Receiving a Distress Relay Call

When a Distress Relay call is received:

- ➔ The emergency alarm sounds for 2 minutes.
- ➔ “RCVD DISTRESS RELAY” pops up and the LCD backlight blinks.

- ① Push [ALARM OFF] to stop the alarm and the blinking backlight.



- ② Push a softkey to select your desired action.



[IGN]

- ➔ Push to return to the normal operating mode.
 - The transceiver exits the DSC mode.
 - By pushing [PTT], the transceiver also exits the DSC mode.
 - “” continues to blink and the Call is stored in the Received Call Log.

[INFO]

- ➔ Push to display the Received call information. (p. 58)

[ACPT]

- ➔ Push to accept the call.
 - And then, push [CH 16] to switch the operating channel to Channel 16, and then monitor it, as a coast station may require assistance.
 - If you haven't pushed [CH 16] within 10 seconds, the operating channel automatically switches to Channel 16. (p. 62)

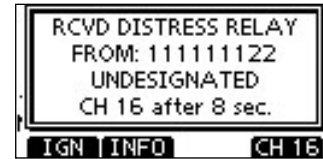

↓ Push

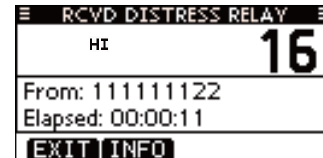

8 DSC OPERATION

◇ Receiving a Distress Relay Acknowledgement

When a Distress Relay Acknowledgement is received:

- The emergency alarm sounds for 2 minutes.
- “RCVD DIST RELAY ACK” pops up and the LCD backlight blinks.

- ① Push [ALARM OFF] to stop the alarm and the blinking backlight.



- ② Push a softkey to select your desired action.



[IGN]

- Push to return to the normal operating mode.
 - The transceiver exits the DSC mode.
 - By pushing [PTT], the transceiver also exits the DSC mode.
 - “✉” continues to blink and the Call is stored in the Received Call Log.

[INFO]

- Push to display the Received call information. (p. 58)

[ACPT]

- Push to accept the call.
And then, push [CH 16] to switch the operating channel to Channel 16, and then monitor it, as a coast station may require assistance.
 - If you haven't pushed [CH 16] within 10 seconds, the operating channel automatically switches to Channel 16. (p. 62)



↓ Push

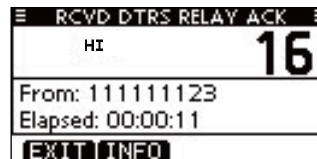

◇ Receiving an Individual Call

When an Individual Call is received:

- The alarm sounds for 2 minutes.
- “RCVD INDIVIDUAL CALL” pops up. The LCD backlight may blink for 2 minutes, depending on the received Category.

- ① Push [ALARM OFF] to stop the alarm and the blinking backlight.
 - If [ALARM OFF] is not pushed within 2 minutes, the next screen may appear, depending on the received Category.



- ② Push a softkey to select your desired action.



[IGN]

- Push to ignore the Call and return to the normal operating mode.
 - The transceiver exits the DSC mode.
 - The Call is stored in the Received Call Log.
 - “” continues to blink and the Call is stored in the Received Call Log.

[INFO]

- Push to display the Received call information. (p. 58)

[ACK]

- Push to display the “INDIVIDUAL ACK” screen to reply to the Call, and select the channel specified by the calling station for voice communication, depending on your situation. See page 31 for details of the Individual Acknowledgement procedure.



When “INDIVIDUAL ACK” is set to “Auto ACK (Unable),” the transceiver automatically replies to the Call. In that case, both the TX and RX calls are stored in the Transmitted and Received Call Logs.

8 DSC OPERATION

◇ Receiving a Group Call

When a Group Call is received:

- The alarm sounds for 2 minutes.
- “RCVD GROUP CALL” pops up. The LCD backlight may blink for 2 minutes, depending on the received Category.

- ① Push [ALARM OFF] to stop the alarm and the blinking backlight.
 - If [ALARM OFF] is not pushed within 2 minutes, the next screen may appear, depending on the received Category.



- ② Push a softkey to select your desired action.



[IGN]

- Push to ignore the Call and return to the normal operating mode.
 - The transceiver exits the DSC mode.
 - “☑” continues to blink and the Call is stored in the Received Call Log.

[INFO]

- Push to display the Received call information. (p. 58)

[ACPT]

- Push to monitor the channel specified by the calling station (Example: 08) for an announcement from the calling station.

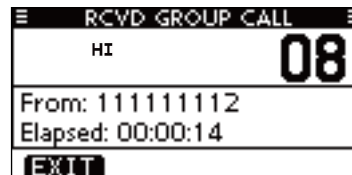

◇ Receiving an All Ships Call

When an All Ships Call is received:

- The alarm sounds for 2 minutes.
- “RCVD ALL SHIPS CALL” pops up. The LCD backlight may blink for 2 minutes, depending on the received Category.

- ① Push [ALARM OFF] to stop the alarm and the blinking backlight.
 - If [ALARM OFF] is not pushed within 2 minutes, the next screen may appear, depending on the received Category.



- ② Push a softkey to select your desired action.



[IGN]

- Push to ignore the Call and return to the normal operating mode.
 - The transceiver exits the DSC mode.
 - “☑” continues to blink and the Call is stored in the Received Call Log.

[INFO]

- Push to display the Received call information. (p. 58)

[ACPT]

- Push to monitor the channel specified by the calling station (Example: 16) for an announcement from the calling station.

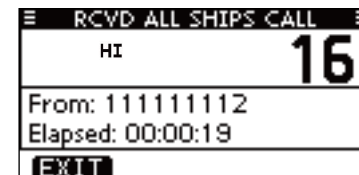

8 DSC OPERATION

◇ Receiving a Geographical Area Call

When a Geographical Area Call (for the area you are in) is received:

- The alarm sounds for 2 minutes.
- “RCVD GEOGRAPHICAL CALL” pops up. The LCD backlight may blink for 2 minutes, depending on the received Category.

- ① Push [ALARM OFF] to stop the alarm and the blinking backlight.
 - If [ALARM OFF] is not pushed within 2 minutes, the next screen may appear, depending on the received Category.



- ② Push a softkey to select your desired action.

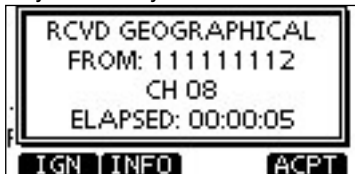

[IGN]

- Push to ignore the Call and return to the normal operating mode.
 - The transceiver exits the DSC mode.
 - “☑” continues to blink and the Call is stored in the Received Call Log.

[INFO]

- Push to display the Received call information. (p. 58)

[ACPT]

- Push to monitor the channel specified by the calling station (Example: 08) for an announcement from the calling station.

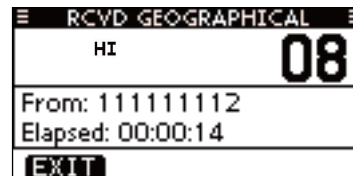

/// When no GPS data is received or if there is a problem with the connected receiver, all Geographical Area Calls are received, regardless of your position.

◇ Receiving a Position Request Call

When a Position Request Call is received:

- ➔ The alarm sounds for 2 minutes.
- ➔ “RCVD POS REQUEST” pops up. The LCD backlight blinks for 2 minutes.

- ① Push [ALARM OFF] to stop the alarm and the blinking backlight.
 - If [ALARM OFF] is not pushed within 2 minutes, the next screen may appear, depending on the received Category.



- ② Push a softkey to select your desired action.



[IGN]

- ➔ Push to ignore the Call and return to the normal operating mode.
 - The transceiver exits the DSC mode.
 - “☑” continues to blink and the Call is stored in the Received Call Log.

[INFO]

- ➔ Push to display the Received call information. (p. 58)

[ACK]

- ➔ Push to display the “POSITION REPLY” screen and send a reply to the Call. (p. 40)



When “POSITION ACK” is set to “Auto TX,” the transceiver automatically replies to the Call. In that case, both the TX and RX calls are stored in the Transmitted and Received Call Logs.

8 DSC OPERATION

◇ Receiving a Position Report Call

When a Position Report Call is received:

- The alarm sounds for 2 minutes.
- "RCVD POSITION REPORT" pops up. The LCD backlight blinks for 2 minutes.

- ① Push [ALARM OFF] to stop the alarm and the blinking backlight.
 - If [ALARM OFF] is not pushed within 2 minutes, the next screen may appear, depending on the received Category.



- ② Push a softkey to select your desired action.

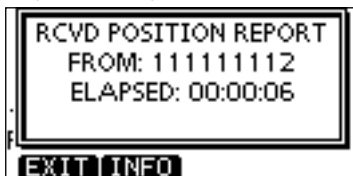

[EXIT]

- Push to ignore the Call and return to the normal operating mode.
 - The transceiver exits the DSC mode.
 - "☑" continues to blink and the Call is stored in the Received Call Log.

[INFO]

- Push to display the Received call information. (p. 58)

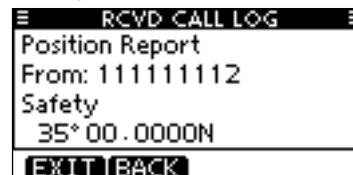

◇ Receiving a Polling Request call

When a Polling Request call is received:

- ➔ The alarm sounds for 2 minutes.
- ➔ “RCVD POLLING REQUEST” pops up. The LCD backlight blinks for 2 minutes.

- ① Push [ALARM OFF] to stop the alarm and the blinking backlight.
 - If [ALARM OFF] is not pushed within 2 minutes, the next screen may appear, depending on the received Category.

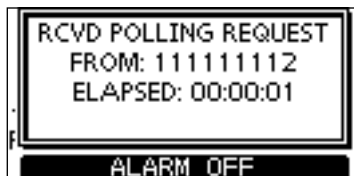

- ② Push a softkey to select your desired action.

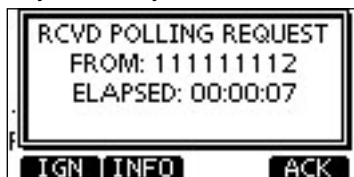

[IGN]

- ➔ Push to ignore the Call and return to the normal operating mode.
 - The transceiver exits the DSC mode.
 - “☑” continues to blink and the Call is stored in the Received Call Log.

[INFO]

- ➔ Push to display the Received call information. (p. 58)

[ACK]

- ➔ Push to display the “POLLING REPLY” screen to reply to the Call. (p. 44)

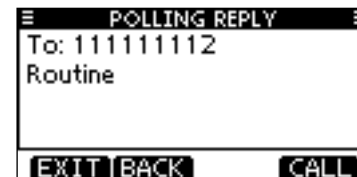

When “POSITION ACK” is set to “Auto TX,” the transceiver automatically replies to the Call. In that case, both the TX and RX calls are stored in the Transmitted and Received Call Logs.

8 DSC OPERATION

◇ Receiving a Test Call

When a Test Call is received:

- The alarm sounds for 2 minutes.
- “RCVD TEST CALL” pops up. The LCD backlight blinks for 2 minutes.

- ① Push [ALARM OFF] to stop the alarm and the blinking backlight.
 - If [ALARM OFF] is not pushed within 2 minutes, the next screen may appear, depending on the received Category.

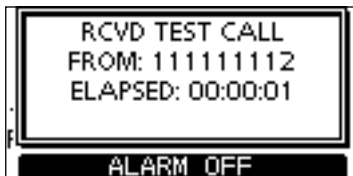

- ② Push a softkey to select your desired action.

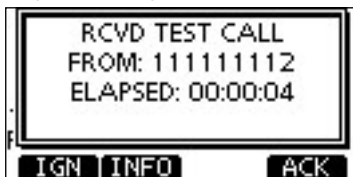

[IGN]

- Push to ignore the Call and return to the normal operating mode.
 - The transceiver exits the DSC mode.
 - “☑” continues to blink and the Call is stored in the Received Call Log.

[INFO]

- Push to display the Received call information. (p. 58)

[ACK]

- Push to display the “TEST ACK” screen to reply to the Call. (p. 38)

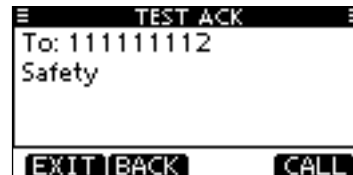

When “TEST ACK” is set to “Auto TX,” the transceiver automatically replies to the Call. In that case, both the TX and RX calls are stored in the Transmitted and Received Call Logs.

◇ Receiving a Test Acknowledgement Call

When a Test Acknowledgement Call is received:

- ➔ The alarm sounds for 2 minutes.
- ➔ “RCVD TEST ACK” pops up. The LCD backlight blinks for 2 minutes.

- ① Push [ALARM OFF] to stop the alarm and the blinking backlight.
 - If [ALARM OFF] is not pushed within 2 minutes, the next screen may appear, depending on the received Category.



- ② Push [EXIT] to return to the normal operating mode.

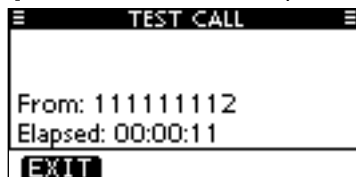

- The transceiver exits the DSC mode.
- “☑” continues to blink and the Call is stored in the Received Call Log.

■ Received Call log

The transceiver automatically stores up to 50 distress messages and 50 other messages, and they can be used as a supplement to your logbook.

- While in the normal operating mode, “☑” blinks in the upper right corner of the LCD when there is an unread message.

◇ Distress message

- ① Push [LOG] to enter “RCVD CALL LOG” in the DSC CALLS menu, or you can enter it through the Menu screen.

<MENU> ⇄ <DSC Calls> ⇄ <Received Call Log>
 (Push [MENU]) (Push [▲]/[▼], then push [ENTER].)

- ② Push [▲] or [▼] to select “Distress,” then push [ENTER].
 - The Distress messages are stored in “Distress.”
 - “☑” appears when there are unread messages.
 - “☒” appears when there are no unread messages.
 - No icon appears when there are no messages.



8 DSC OPERATION

- ③ Push [▲] or [▼] to select the desired item, then push [ENTER].

- The message in the unopened file has not been read.

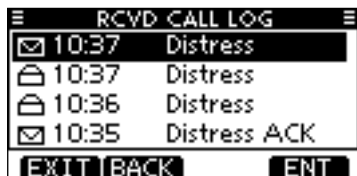

- ④ Push [▲] or [▼] to scroll the message contents.

- Pushing [WP] stores the received position. (p. 68)

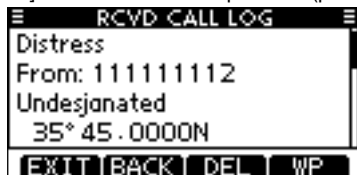

- ⑤ To delete the displayed message, push [DEL].
- The confirmation screen appears, then push [OK] to delete.
- ⑥ Push [EXIT] to return to the normal operating mode.

◆ Other messages

- ① Push [LOG] to enter "RCVD CALL LOG" in the DSC CALLS menu, or you can enter it through the Menu screen.

<MENU>	⇄	<DSC Calls>	⇄	<Received Call Log>
(Push [MENU])		(Push [▲]/[▼],		then push [ENTER].)

- ② Push [▲] or [▼] to select "Others," then push [ENTER].

- The messages other than the Distress are stored in "Others."
- "✉" appears when there are unread messages.
- "👛" appears when there are no unread messages.
- No icon appears when there are no messages.



- ③ Push [▲] or [▼] to select the desired item, then push [ENTER].

- The message in the unopened file has not been read.

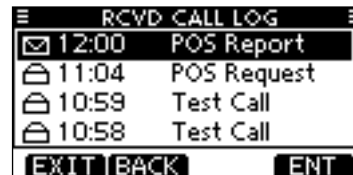

- ④ Push [▲] or [▼] to scroll the message contents.
- The stored message has various information, depending on the DSC call type.
 - Pushing [WP] stores the received position. (p. 68)

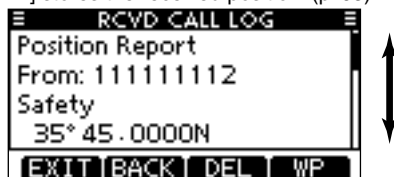

- ⑤ To delete the displayed message, push [DEL].
- The confirmation message screen appears, then push [OK] to delete.
- ⑥ Push [EXIT] to return to the normal operating mode.

■ Transmitted Call log

The transceiver automatically stores up to 50 transmitted calls, and the logs can be used as a supplement to your log-book.

- ① Enter "TX CALL LOG" in the DSC CALLS menu.

◀MENU> ⇄ <DSC Calls> ⇄ <Transmitted Call Log>
(Push [MENU]) (Push [▲]/[▼], then push [ENTER].)

- ② Push [▲] or [▼] to select the desired item, then push [ENTER].



- ④ Push [▲] or [▼] to scroll the message contents.



- ④ To delete the displayed message, push [DEL].
- The confirmation screen appears, then push [OK] to delete.
- ⑤ Push [EXIT] to return to the normal operating mode.

■ DSC Settings

- ◇ Position Input (See page 24)
- ◇ Add Individual ID/Group ID (See pages 21 and 22)
- ◇ Delete Individual ID/Group ID (See page 23)

◇ Automatic Acknowledgement

These items set the Automatic Acknowledgement function to “Auto TX” or “Manual TX.”

When an Individual, Position Request, Polling Request or Test Call is received, the transceiver automatically transmits an Individual Acknowledgement, Position Reply, Polling Reply or Test Acknowledgement Call, respectively.

When “INDIVIDUAL ACK” is set to “Auto TX,” the transceiver automatically transmits the Acknowledgment call including “Unable to Comply” (No Reason Given) after receiving the Individual call.

- ① Enter either “INDIVIDUAL ACK,” “POSITION ACK” or “TEST ACK” in the DSC Settings menu.

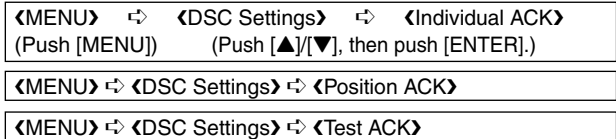

- ② Push [▲] or [▼] to select “Auto TX” or “Manual TX,” then push [ENTER].
 - Push [BACK] to cancel and return to the DSC Settings menu.

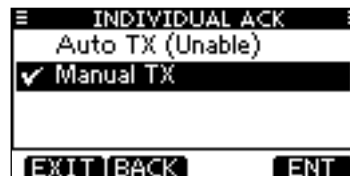

(default: Manual)

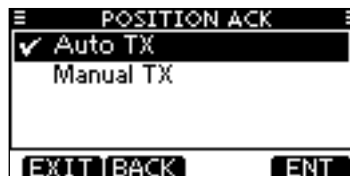

(default: Auto TX)

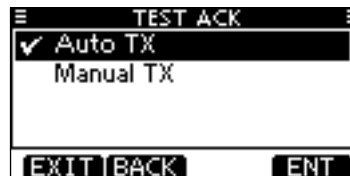

(default: Auto TX)

- ③ Push [EXIT] to return to the normal operating mode.

◇ Channel 16 Switch function

By regulation, after receiving a Distress call, the transceiver switches the operating channel to Channel 16. However, when this setting is set to “OFF,” the function enables the transceiver to remain on the operating channel, even after receiving a Distress call.

- ① Enter “CH 16 SWITCH” in the DSC Settings menu.

◀MENU	↔	◀DSC Settings	↔	◀CH 16 Switch
(Push [MENU])		(Push [▲]/[▼], then push [ENTER].)		

- ② Push [▲] or [▼] to set the Channel 16 Switch function to “Auto (No Delay),” “10 Second Delay” or “OFF,” then push [ENTER].
- Push [BACK] to cancel and return to the DSC Settings menu.

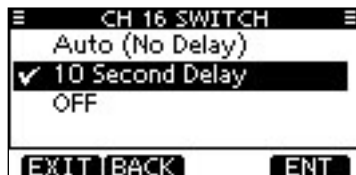

(default)

- Auto (No Delay) : After receiving a Distress call, and [ACPT] is pushed on the confirmation screen, the transceiver immediately switches to Channel 16.
- 10 Second Delay : After receiving a Distress call, and [ACPT] is pushed on the confirmation screen, the transceiver remains on the current operating channel for 10 seconds. After that, the transceiver automatically switches to Channel 16. (default)
- OFF : Even after receiving a Distress call, the transceiver remains on the operating channel.
- “” appears.

- ③ Push [EXIT] to return to the normal operating mode.

8 DSC OPERATION

◇ Alarm

Set the Alarm function ON or OFF, depending on the Category or Status.

- ① Enter "ALARM" in the DSC Settings menu.

◀MENU▶ ⇄ ▶DSC Settings▶ ⇄ ▶Alarm▶
(Push [MENU]) (Push [▲]/[▼], then push [ENTER].)

- ② Push [▲] or [▼] to select the status, then push [ENTER].
 - Push [BACK] to cancel and return to the DSC Settings menu.
 - "Safety," "Routine," "Warning," "Self-Terminate" and "Discrete" are selectable. (default: ON)

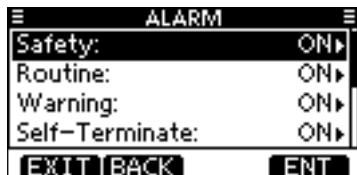

- ③ Push [▲] or [▼] to set the Alarm setting to "ON" or "OFF."
- ④ Push [EXIT] to return to the normal operating mode.

◇ Channel 70 Squelch level

Set the squelch level on Channel 70.

The transceiver has 11 squelch levels between 1 (loose squelch) and 10 (tight squelch) and OPEN. OPEN is completely open.

- ① Enter "CH 70 SQL LEVEL" in the DSC Settings menu.

◀MENU▶ ⇄ ▶DSC Settings▶ ⇄ ▶CH 70 SQL Level▶
(Push [MENU]) (Push [▲]/[▼], then push [ENTER].)

- ② Push [▲]/[▼]/[◀]/[▶] to adjust the squelch level until the noise just disappears, then push [ENTER].
 - Push [BACK] to cancel and return to the DSC Settings menu.

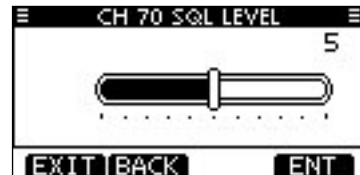

(default)

- ③ Push [EXIT] to return to the normal operating mode.

◇ DSC Loop Test

The DSC loop test function sends transmit DSC signals to the receive AF circuit to compare and check the TX and RX signals at the AF level.

- 1 Enter “DSC LOOP TEST” in the DSC Settings menu.

◀MENU▶ ⇄ ▶DSC Settings▶ ⇄ ▶DSC Loop Test▶
 (Push [MENU]) (Push [▲]/[▼], then push [ENTER].)

- 2 Push [ENTER] to start the DSC loop test.
 - Push [BACK] to cancel and return to the DSC Settings menu.



- When the transmit DSC and receive DSC signals are matched, “OK” appears.
- 3 Push [EXIT] to return to the normal operating mode.

▨ If “NG” appears in step ②, either or both TX and RX DSC circuits has a problem. In that case, you will have to send the transceiver to your nearest dealer for repair.

◇ Channel 70 Watch function

Select whether or not the transceiver monitors Channel 70.

- 1 Enter “CH 70 Watch” in the DSC Settings menu.

◀MENU▶ ⇄ ▶DSC Settings▶ ⇄ ▶CH 70 Watch▶
 (Push [MENU]) (Push [▲]/[▼], then push [ENTER].)

- 2 Push [▲] or [▼] to set the Channel 70 Watch function to “Busy” or “Standby,” then push [ENTER].
 - Push [BACK] to cancel and return to the DSC Settings menu.



(default)

Standby : While receiving no signal, the transceiver monitors Channel 70 according to the Scan Speed time cycle.

Busy : While receiving no signal on the operating channel, the transceiver monitors Channel 70 according to the Scan Speed time cycle. While receiving a signal on the operating channel, the transceiver monitors Channel 70 every 1.5 seconds.

- 3 Push [EXIT] to return to the normal operating mode.

■ MOB (Man OverBoard)

The transceiver can register an MOB (Man OverBoard*) point with its position data.

* The situation in which a person has fallen into the water and is in need of rescue.

To store an MOB point:

- ① Hold down [MOB] for 1 second to store the MOB point.
 - Two beeps sound.
 - After memorizing the MOB point, the information screen “MAN OVERBOARD!” appears.
 - If the GPS receiver has not yet calculated the position, the MOB point cannot be stored.
 - Only one MOB point can be memorized, and the previously stored point is overwritten when a new MOB point is stored.

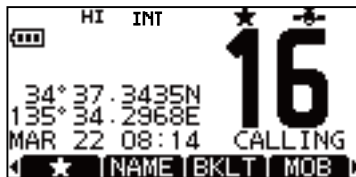

- ② After the information screen appears, push [ENTER] to open the MOB screen, then the navigation to the stored point will start. See page 72 for the navigation details.
 - If no key operation is performed for 10 seconds, the transceiver returns to the previous screen. Or push any key to manually return.



- ③ Push [EXIT] to exit the Navigation screen and return to the normal operating mode.



To check the stored MOB point:

- ① Push [MENU] to enter the MENU screen.
- ② Push [▲]/[▼] and select "MOB" to enter the MOB screen.
 - The MOB screen appears.
 - Pushing [MOB] on the softkey also opens the screen.
 - When the MOB point has not been stored, or has been deleted, a blank screen appears.



- ③ Push a softkey to select your desired action.

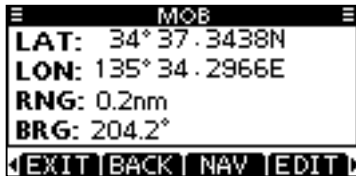

- Push [EXIT] to return to the normal operating mode.
- Push [BACK] to return to the MENU screen.

Starting Navigation to the MOB point: Push [NAV]

The transceiver can navigate to the MOB point.

- ➔ Push [NAV] to start navigation to the MOB point.

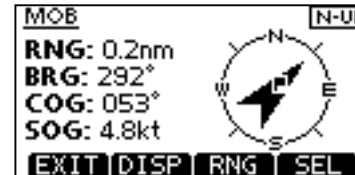
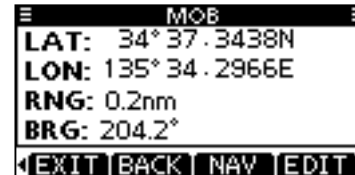

See page 72 for navigation details.

9 OTHER FUNCTIONS

■ MOB (Man Overboard) (Continued)

Editing the MOB point: Push [EDIT]

The stored MOB position can be changed.

- ① Push [EDIT] to enter the position data editing screen.
- ② Edit specific latitude and longitude data in the following way:
 - Select a desired number using [▲]/[▼]/[◀]/[▶].
 - Push [ENTER] to set the digit.
 - Select N (North latitude) or S (South latitude) when the cursor is on the 'N' or 'S' position.
 - Select W (West longitude) or E (East longitude) when the cursor is on the 'W' or 'E' position.
 - To move the cursor, select either arrow, "←" or "→," then push [ENTER].
 - To set the screen data, select "FINISH," then push [ENTER].



- ③ After the confirmation screen appears, push [OK] to save the position data and return to the MOB screen.

Deleting an MOB point: Push [DEL]

The stored MOB point can be deleted.

Please note that a deleted MOB point cannot be restored.

- ① Push [DEL] to delete the MOB point.
 - The confirmation screen "ARE YOU SURE?" appears.
- ② Push [OK] to delete the data and return to the MOB screen.



- A blank screen appears.
- Push [EXIT] to return to the normal operating mode.
- Push [BACK] to return to the MENU screen.

Waypoint

You can store your vessel's position information wherever you are, and also the position information of the vessel you received a DSC call from, as a waypoint. The transceiver can store up to 50 waypoints. Each waypoint can be programmed with an alphanumeric name for easy recognition. Names can be a maximum of 10 characters.

To store your position:

- Hold down [WP] for 1 second to store the waypoint.
 - Two beeps sound.
 - After memorizing the waypoint, the information screen "WAYPOINT WAS STORED" appears.
 - If the GPS receiver has not yet calculated the position, the waypoint cannot be stored.
 - If you have already stored 50 waypoints, the new waypoint cannot be stored.

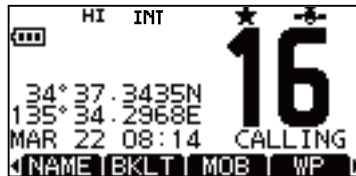

To store a received position:

After receiving a DSC call that includes the position information, the position can be registered as a waypoint.

- ① Enter "RCVD CALL LOG" in the DSC CALLS menu.

◀[MENU]▶ ⇄ ◀[DSC Calls]▶ ⇄ ◀[Received Call Log]▶
 (Push [MENU]) (Push [▲]/[▼], then push [ENTER].)

- Pushing the [LOG] softkey also opens the screen.
- ② Push [▲] or [▼] to select "Distress" or "Others," then push [ENTER].
 - ③ Push [▲] or [▼] to select the desired item, then push [ENTER].
 - ④ Push [WP] to store.



- The confirmation screen "STORE WAYPOINT?" appears.
- ⑤ Push [OK] to register the received position as a waypoint.
 - If you have already stored 50 waypoints, the new waypoint cannot be stored.
 - The received position is stored with its MMSI ID code as the waypoint name. If the ID code has been programmed in your Individual address, the position is stored with the name instead of the ID code.

9 OTHER FUNCTIONS

■ Waypoint (Continued)

To check the stored waypoint:

- ① Push [MENU] to enter the MENU screen.
- ② Push [▲]/[▼] to select “Waypoint” to enter the waypoint list screen.
 - The waypoint list screen appears.
 - Pushing the [WP] softkey also opens the screen.

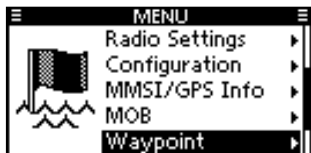

- ③ Push [▲]/[▼] to select the desired waypoint, then push [ENTER] to open the waypoint screen. Or push a softkey on the waypoint list screen to select your desired action.

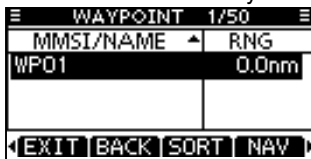

↓ Push [ENTER]

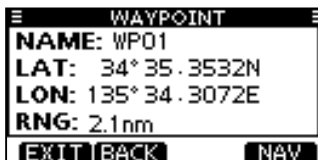

Sorting the waypoints: Push [SORT]

The transceiver can sort the waypoints on the waypoint list screen.

- ➔ Push [SORT] one or more times to sort your desired waypoint's order.
 - The forward or reverse order of the “MMSI/NAME” and forward or reverse order of the “RNG” (Range) can be selected.
 - “▲” or “▼” appears beside the MMSI/NAME or RNG title.

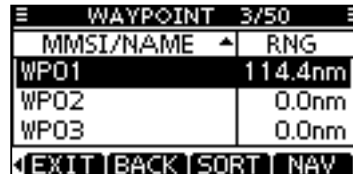

Starting Navigation to the waypoint: Push [NAV]

The transceiver can navigate to the waypoint.

- ➔ Push [NAV] to start navigation to the waypoint.

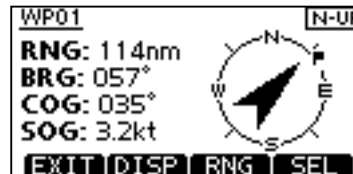

See page 72 for navigation details.

Adding the waypoint: Push [ADD]

New waypoints can be manually programmed with a name and position data.

- ① Push [ADD] to enter the name programming screen.
 - Any one of “WP01” to “WP50” appears as a default name.



- ② If desired, enter a 10 digit name in the following way:
 - Select a desired character using [▲]/[▼]/[◀]/[▶].
 - Push [ENTER] to set it.
 - To move the cursor, select either arrow, “←” or “→,” then push [ENTER].
 - Push [123], [!\$?] or [ABC] to select a character group.

- ③ After entering the name, select “FINISH” by pushing [▲]/[▼]/[◀]/[▶], then push [ENTER] to set it and enter the position data editing screen.
 - The current position data appears on each screen, as the default.
 - Select a desired number using [▲]/[▼]/[◀]/[▶].
 - Select N (North latitude) or S (South latitude) when the cursor is on the ‘N’ or ‘S’ position.
 - Select W (West longitude) or E (East longitude) when the cursor is on the ‘W’ or ‘E’ position.
 - To move the cursor, select either arrow, “←” or “→,” then push [ENTER].
 - To set the screen data, select “FINISH,” then push [ENTER].



- ④ After the confirmation screen appears, push [OK] to save the waypoint and return to the waypoint list screen.

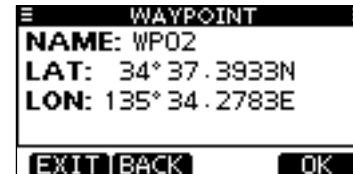

9 OTHER FUNCTIONS

■ Waypoint (Continued)

Editing the waypoint: Push [EDIT]

The stored waypoint name and its position data can be changed.

- 1 Push [EDIT] to enter the name programming screen.
 - The preprogrammed name is displayed.
 - If desired, enter a 10 digit name as described in the step 2 of the previous page.



- 2 Edit specific latitude and longitude data in the following way:
 - The preprogrammed position data appears on each screen.
 - Select a desired number using [▲]/[▼]/[◀]/[▶].
 - Push [ENTER] to set the digit.
 - Select N (North latitude) or S (South latitude) when the cursor is on the 'N' or 'S' position.
 - Select W (West longitude) or E (East longitude) when the cursor is on the 'W' or 'E' position.
 - To move the cursor, select either arrow, "←" or "→," then push [ENTER].
 - To set the screen data, select "FINISH," then push [ENTER].



- 3 After the confirmation screen appears, push [OK] to save the waypoint and return to the waypoint list screen.

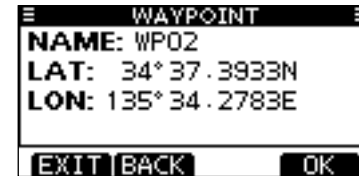

Deleting the waypoint: Push [DEL]

The stored waypoint can be deleted.

Please note that a deleted waypoint cannot be restored.

- 1 Push [DEL] to delete the waypoint.
 - The confirmation screen "ARE YOU SURE?" appears.
- 2 Push [OK] to delete the waypoint and return to the waypoint list screen.



Navigation

The Navigation function navigates from your current position to the specified waypoint (including MOB point).

The MOB point or waypoint has already been registered.

Starting Navigation to the MOB point:

The transceiver can navigate to the MOB point.

- ① Push [MENU] to enter the MENU screen.
- ② Push [▲]/[▼] and select "MOB" to enter the MOB screen.
 - The MOB screen appears.
 - Pushing the [MOB] softkey also opens the screen.
- ③ Push [NAV] to start navigation to the MOB point.

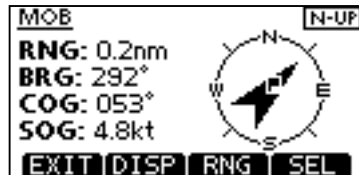
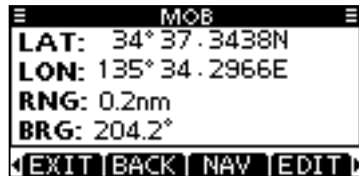

Starting Navigation to the waypoint:

- ① Push [MENU] to enter the MENU screen.
- ② Push [▲]/[▼] to select "Waypoint" to enter the waypoint list screen.
 - The waypoint list screen appears.
 - Pushing the [WP] softkey also opens the screen.
- ③ Push [▲]/[▼] to select the desired waypoint, then push [NAV] to start navigation to the waypoint.

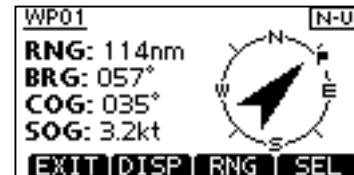
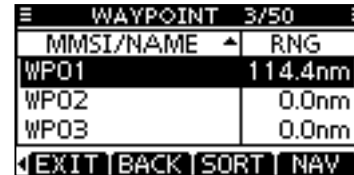

9 OTHER FUNCTIONS

Navigation (Continued)

Navigation screen description:

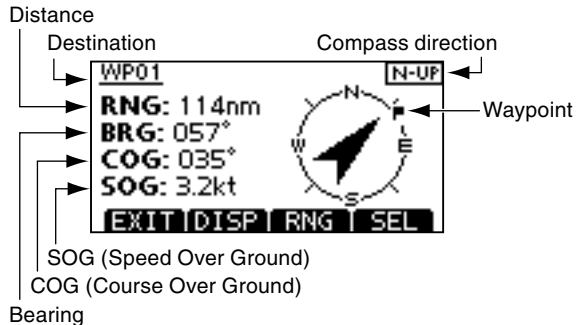

- Push [DISP] to toggle the display type. Two display types are selectable.

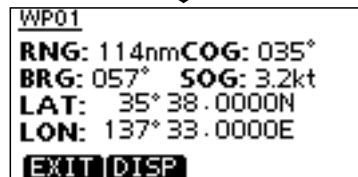
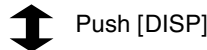
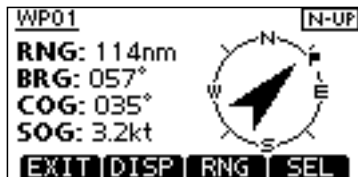

- Push [RNG] to open the range setting window, then push [▲]/[▼]/[◀]/[▶] to select the desired range. Eight ranges are selectable. The range shows the radius of a compass circle.



- Push [SEL] to select compass direction from N-UP, W-UP and AC-UP.
 - N-UP : The top is always north.
 - W-UP : The top is always the waypoint (your destination).
 - AC-UP : The compass is always pointed in your course heading direction.
- Push [EXIT] to return to the normal operating mode.

■ Compass screen

The compass screen displays your vessel's COG (Course Over Ground) and SOG (Speed Over Ground) which can be checked at a glance.

Push [COMP].

- The screen as shown below is displayed.

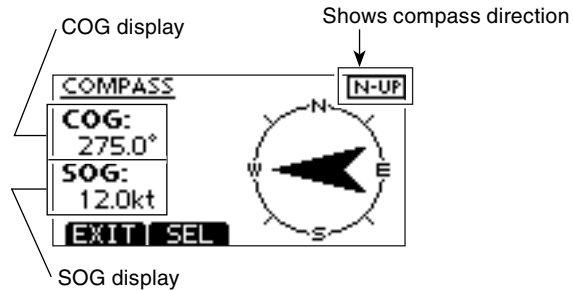

- Push [SEL] to select compass direction between N-UP and AC-UP.
 - N-UP : The top is always north
 - AC-UP : The compass is always pointed in your course heading direction.
- Push [EXIT] to return to the normal operating mode.

■ GPS status screen

GPS Status displays the quantity, signal power and position of the GPS satellites.

Sky view shows the position of visible GPS satellites.

The screen also shows the direction, elevation angle, satellite numbers and their receiving signal strength status.

- ① Push [MENU] to enter the menu screen.
- ② Push [▲]/[▼] to select "GPS Status," then push [ENTER].

- Sky view screen is displayed.

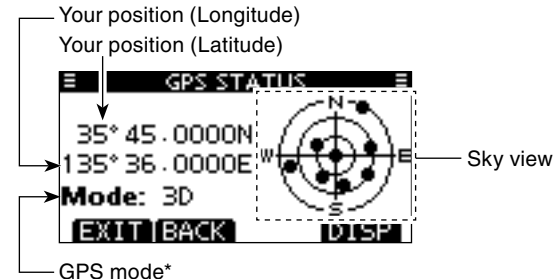

- Push [DISP] each time to toggle between the sky view and satellite signal power screens.
- Push [BACK] to return to the menu screen.
- Push [EXIT] to return to the normal operating mode.

**"3D" is displayed when more than 4 satellites are tracked. When less than 3 satellites are tracked, "2D" is displayed.

9 OTHER FUNCTIONS

■ GPS status screen (Continued)

• About the sky view

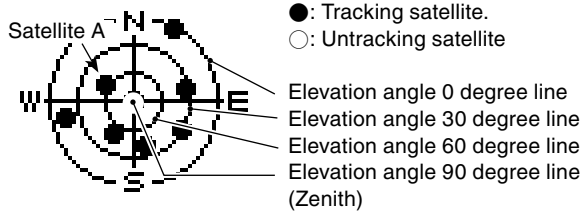

• The image of the satellite

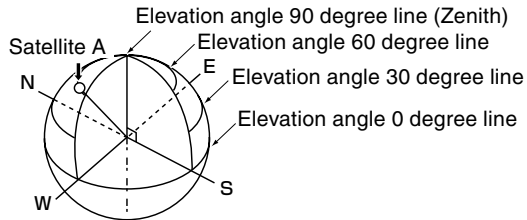

• Satellite signal power screen description

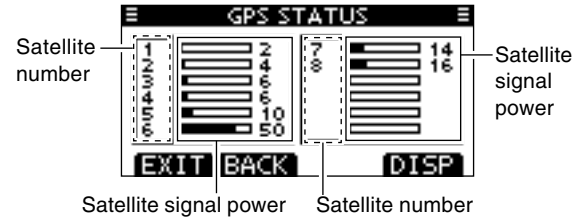

The untracking satellite numbers blink.

Menu screen operation

The Menu screen is used for programming infrequently changed values, function settings or sending DSC calls.

In addition to this page, see pages 78 through 82 for details.



Menu lists

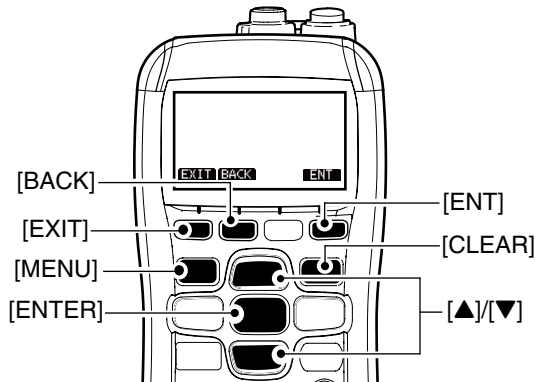

◇ Entering the Menu screen and operation

Example: Set the channel group to “USA.”

① Push [MENU].



② Push [▲]/[▼] to select the root item (Radio Settings), and then push [ENTER].



- If [▲] or [▼] is continuously held down, the items are sequentially highlighted.

③ Push [▲]/[▼] to select “CHAN Group,” and then push [ENTER].



④ Push [▲]/[▼] to select “USA,” and then push [ENTER] to set it.

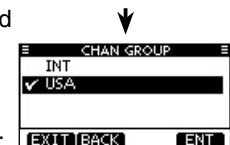

- “✓” is displayed next to “USA.”

⑤ Push [EXIT] to exit the Menu screen.

- Push [CLEAR] or [BACK] to return to the previous screen.

10 MENU SCREEN OPERATION

■ Menu screen items

The Menu screen contains the following items.

◇ DSC Calls

Item	Ref.	Item	Ref.
• Individual Call	p. 29	• Received Call Log	p. 58
• Individual ACK*1	p. 31	• Transmitted Call Log	p. 60
• Group Call	p. 33	• Test Call	p. 36
• All Ships Call	p. 35	• Test ACK*1	p. 38
• Distress Call	p. 25		

*1 Appears only after receiving a corresponding call.

◇ DSC Settings

Item	Ref.	Item	Ref.
• Position Input*2	p. 24	• CH 16 Switch	p. 62
• Individual ID	p. 21	• Alarm	p. 63
• Group ID	p. 22	• CH 70 SQL Level	p. 63
• Individual ACK	p. 61	• DSC Loop Test	p. 64
• Position ACK	p. 61	• CH 70 Watch	p. 64
• Test ACK	p. 61		

*2 Appears only when no GPS information is received.

◇ Radio Settings

Item	Ref.	Item	Ref.
• Scan Type*3	p. 78	• Dual/Tri-Watch*3	p. 78
• Scan Timer*3	p. 78	• Channel Group*4	p. 78

*3 Available except for the Dutch version.

*4 Available except for the European version.

◇ Configuration

Item	Ref.	Item	Ref.
• Backlight	p. 79	• Noise Cancel	p. 80
• Display Contrast	p. 79	• Inactivity Timer	p. 81
• Key Beep	p. 79	• Float 'n Flash	p. 82
• Key Assignment	p. 79	• Monitor	p. 81
• UTC Offset	p. 80	• Unit	p. 81

◇ MMSI/GPS Information

The transceiver shows the programmed MMSI code and GPS information.

If the code is not programmed, "NO DSC MMSI" is displayed.



◇ **MOB** (See pages 65 to 67 for information)

◇ **Waypoint** (See pages 68 to 71 for information)

◇ **GPS Status** (See pages 74 to 75 for information)

■ Radio Settings items

◇ Scan type

Except for the Dutch version, the transceiver has two scan types; Normal scan and Priority scan. A Normal scan searches all Favorite channels in the selected channel group. A Priority scan sequentially searches all Favorite channels, while monitoring Channel 16. (Default: Priority Scan)

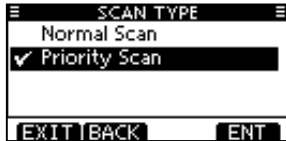

◇ Scan timer

Except for the Dutch version, the scan resume timer can be selected as a pause (OFF) or a timer scan (ON). When OFF is selected, the scan pauses until the signal disappears. When ON is selected, the scan pauses for 5 seconds and then resumes, even if a signal has been received on any channel other than Channel 16. (Default: OFF)



◇ Dual/Tri-watch

Except for the Dutch version, this item can be selected as Dualwatch or Tri-watch. (p. 20) (Default: Dualwatch)



◇ Channel Group

Except for the European version, a channel group suitable for your operating area can be selected. Depending on the transceiver version, INT, USA, ATIS and or DSC may be selectable. (Default: INT)

See page 13 for details.

- The screen below shows the U.K. version.



10 MENU SCREEN OPERATION

■ Configuration items

◇ Backlight

The function display and keys can be backlit for better visibility under low light conditions.

The backlight can be set to 7 levels and OFF. (Default: 4)

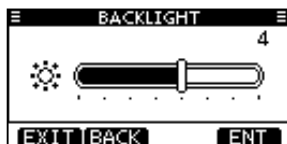

◇ Display contrast

This item adjusts the contrast of the LCD in 8 steps.

Level 1 is the lowest contrast, and level 8 is the highest contrast. (Default: 3)

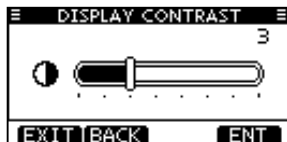

◇ Key Beep

You can turn OFF beep tones for silent operation, or you can turn ON the tones to have confirmation beeps sound when a key is pushed. (Default: ON)

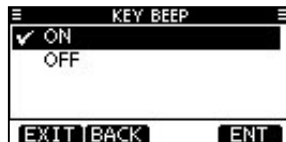

◇ Key Assignment

Desired functions can be assigned to the softkeys.

① When the “KEY ASSIGNMENT” screen is displayed, push [▲]/[▼] to select the desired softkey, and then push [ENTER].

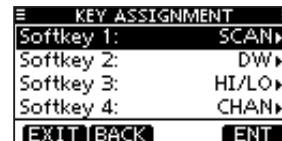

• To return to the default, select “Set default” and then push [ENTER].

③ Push [▲]/[▼] to select the option, and then push [ENTER] to set it.

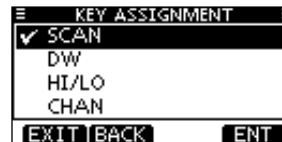

• “✓” is displayed next to the selected option.

◇ UTC Offset

Set the offset time between the UTC (Universal Time Coordinated) and your local time to between -14:00 and +14:00 (in 1 minute steps). (Default: 00:00)



◇ Noise Cancel

Set the Noise Cancel function for both receive and transmit.

- ① When the "NOISE CANCEL" screen is displayed, push [▲]/[▼] to select "RX" or "TX," and then push [ENTER].

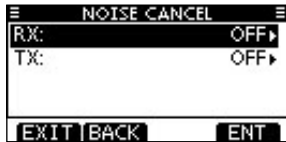

- ② Push [▲]/[▼] to select the option, and then push [ENTER] to set it.
 - "✓" is displayed next to the selected option.
- ③ Push [EXIT] to exit the Menu screen.
 - Push [CLEAR] or [BACK] to return to the previous screen.

• RX

Turn the receive Noise Cancel function ON or OFF.

(Default: OFF)

OFF : Turns OFF the function.

- 1 : The Noise Cancel function reduces random noise components in the received signal to approximately one half.
- 2 : The Noise Cancel function reduces random noise components in the received signal to approximately one third.
- 3 : The Noise Cancel function reduces random noise components in the received signal to approximately one tenth.

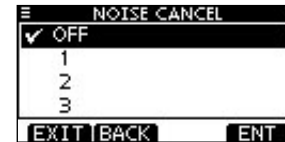

• TX

Turn the transmit Noise Cancel function ON or OFF.

(Default: OFF)

OFF : Turns OFF the function.

ON : The Noise Cancel function reduces random noise components in the transmitted signal to one third.

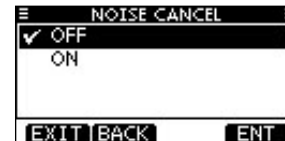

10 MENU SCREEN OPERATION

◇ Inactivity Timer

Set the inactivity timer to between 1 and 10 minutes (in 1 minute steps) or OFF for the “Not DSC Related” items, and to between 1 and 15 minutes or OFF for the “DSC Related” items. The count down alarm sounds 10 seconds before the Inactive timer returns the current screen to the normal operating screen.

- ① When the “INACTIVITY TIMER” screen is displayed, push [▲]/[▼] to select “Not DSC Related” or “DSC Related,” and then push [ENTER].
- ② Push [▲]/[▼] to select the option, and then push [ENTER] to set it.
 - “✓” is displayed next to the selected option.
- ③ Push [EXIT] to exit the Menu screen.
 - Push [CLEAR] or [BACK] to return to the previous screen.

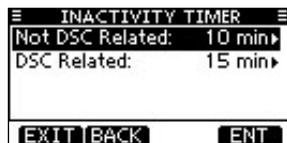

• Not DSC Related

When the LCD displays a screen other than the normal operation screen, or one not related to the DSC, and no key operation occurs for this set period, the transceiver automatically returns to the normal operating screen. (Default: 10 min)



• DSC Related

When the LCD displays the screen related to the DSC, and no key operation occurs for this set period except during distress operation, the transceiver automatically returns to the normal operating screen. (Default: 15 min)



◇ Monitor

Select the desired Monitor switch action. See page 15 for details (Monitor function).



Push : The monitor function is activated by holding down [VOL/SQL] for 1 second. The squelch opens while holding down the key.

Hold : The monitor function is activated by holding down [VOL/SQL] for 1 second. The squelch stays open until any key is pushed.

◇ Unit

Select either the Nautical Mile or Kilo-Meter format to display the distance.

◇ Float 'n Flash

Float 'n Flash function detects that the transceiver has come in contact with water. When the function activates, LCD backlight, keys and trim start to blink to make it easy to find the transceiver even at night or in a dark environment.

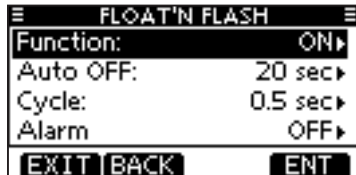

- Function** : Turn the Float 'n Flash function ON or OFF.
(Default: ON)
- Auto OFF** : Set the Auto OFF time period to between 0 and 30 seconds (in 10 second steps). After taking the transceiver out of the water, the LCD backlight keeps blinking during this set period.
(Default: 20 seconds)
- Cycle** : Set the LCD backlight blinking cycle to 0.5, 1, 2 or 4 seconds. The LCD backlight turns ON for 0.5 seconds, and then turns OFF for this set time period.
(Default: 0.5 seconds)
- Alarm** : Select whether or not the alarm sounds while the LCD backlight, keys and trim blink when the Float 'n Flash function is activated.
(Default: OFF)

11 BATTERY CHARGING

■ Battery caution

Misuse of Lithium-ion batteries may result in the following hazards: smoke, fire, or the battery may rupture. Misuse can also cause damage to the battery or degradation of battery performance.

⚠ **DANGER!** Use and charge only specified Icom battery pack with Icom radios or Icom chargers. Only Icom battery packs are tested and approved for use and charge with Icom radios or Icom chargers. Using third-party or counterfeit battery packs or chargers may cause smoke, fire, or cause the battery to burst.

◇ Battery caution

⚠ **DANGER! DO NOT** hammer or otherwise impact the battery. Do not use the battery if it has been severely impacted or dropped, or if the battery has been subjected to heavy pressure. Battery damage may not be visible on the outside of the case. Even if the surface of the battery does not show cracks or any other damage, the cells inside the battery may rupture or catch fire.

⚠ **DANGER! NEVER** use or leave battery pack in areas with temperatures above +55°C. High temperature buildup in the battery, such as could occur near fires or stoves, inside a sun-heated car, or by setting the battery in direct sunlight may cause the battery to rupture or catch fire. Excessive temperatures may also degrade battery performance or shorten battery life.

⚠ **DANGER! DO NOT** expose the battery to rain, snow, saltwater, or any other liquids. Never charge or use a wet battery. If the battery gets wet, be sure to wipe it dry before using. The battery by itself is not waterproof.

⚠ **DANGER! NEVER** incinerate a used battery pack since internal battery gas may cause them to rupture or may cause an explosion.

⚠ **DANGER! NEVER** solder the battery terminals, or **NEVER** modify the battery pack. This may cause heat generation, and the battery may rupture, emit smoke or catch fire.

⚠ **DANGER!** Use the battery only with the transceiver for which it is specified. Never use a battery with any other equipment, or for any purpose that is not described in this instruction manual.

⚠ **DANGER!** If fluid from inside the battery gets in your eyes, blindness can result. Rinse your eyes with clean water, without rubbing them, and see a doctor immediately.

WARNING! Immediately stop using the battery if it emits an abnormal odor, heats up, or is discolored or deformed. If any of these conditions occur, contact your Icom dealer or distributor.

WARNING! Immediately wash, using clean water, any part of the body that comes into contact with fluid from inside the battery.

WARNING! NEVER put the battery in a microwave oven, high-pressure container, or in an induction heating cooker. This could cause overheating, a fire, or cause the battery to rupture.

CAUTION: Always use the battery within the specific temperature range for the transceiver and the battery itself (-15°C to $+55^{\circ}\text{C}$). Using the battery out of its specific temperature range will reduce the battery's performance and battery life. Please note that the specified temperature range of the battery may exceed that of the transceiver. In such cases, the transceiver may not work properly because it is out of its operating temperature range.

CAUTION: Shorter battery life could occur if the battery is left fully charged, completely discharged, or in an excessive temperature environment (above $+50^{\circ}\text{C}$) for an extended period of time. If the battery must be left unused for a long time, it must be detached from the radio after discharging. You may use the battery until the remaining capacity is about half, then keep it safely in a cool dry place with the temperature range as follows:

-20°C to $+50^{\circ}\text{C}$ (within a month)

-20°C to $+35^{\circ}\text{C}$ (within three months)

-20°C to $+25^{\circ}\text{C}$ (within a year)

◇ Charging caution

Charge the battery pack at least once every six months, even if it has been not used for a long period of time. The battery pack will have slowly self-discharged, even though it has not been used. If the battery pack is left for a long period without being charged, its life cycle will be shorter, or worse, it will never accept a charge again.

Due to the characteristics of the Li-ion rectangular battery, the battery pack may change its shape as the charge and discharge cycles are repeated. This is a normal phenomenon, and it is quite

safe to continue to use the pack, as long as it is properly handled. However, when the shape of the battery pack is so changed that the battery pack or battery cover can not be correctly attached to the transceiver, it is time to replace it with a new one. Otherwise, the transceiver can be damaged due to the loss of air tightness.

⚠ **DANGER! NEVER** charge the battery pack in areas with extremely high temperatures, such as near fires or stoves, inside a sun-heated car, or in direct sunlight. In such environments, the safety/protection circuit in the battery will activate, causing the battery to stop charging.

WARNING! DO NOT charge or leave the battery in the battery charger beyond the specified time for charging. If the battery is not completely charged by the specific time, stop charging and remove the battery from the battery charger. Continuing to charge the battery beyond the specific time limit may cause a fire, overheating, or the battery may rupture.

WARNING! NEVER insert the transceiver (battery attached to the transceiver) into the charger if it is wet or soiled. This could corrode the battery charger terminals or damage the charger. The charger is not waterproof.

CAUTION: DO NOT charge the battery outside of the specified temperature range: $\pm 0^{\circ}\text{C}$ to $+45^{\circ}\text{C}$. Icom recommends charging the battery at $+20^{\circ}\text{C}$. The battery may heat up or rupture if charged out of the specified temperature range, and battery performance or battery life may be reduced.

11 BATTERY CHARGING

■ Regular battery charger

◇ BC-204 installation

• To a desktop

Supplied screws

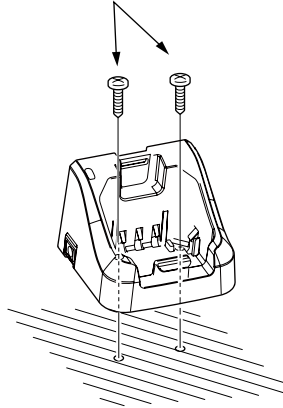

• To a wall

Supplied screws

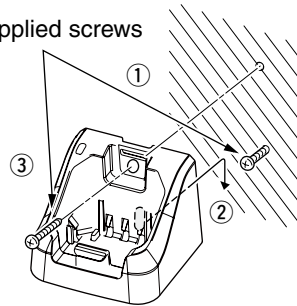

◇ Regular charging with the BC-204 + BC-147S

The BC-204 with BC-147S provides regular charging of the Li-ion battery pack.

• Charging time: approximately 9 hours.

Optional OPC-515L* (for a 13.8 V power source), CP-25 or CP-23L (for a 12 V cigarette lighter socket) can be used instead of the AC adapter.

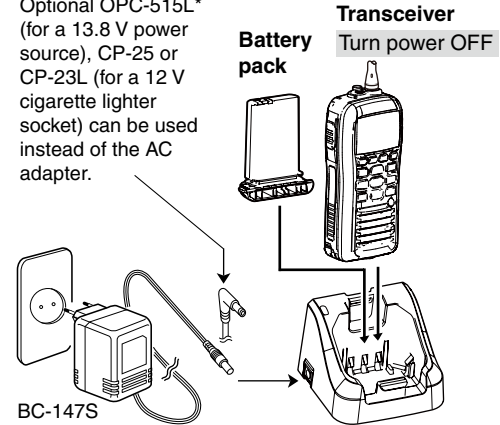

***CAUTION: NEVER** connect the OPC-515L to a power source using reverse polarity. This will ruin the battery charger.

White line: ⊕ Black line: ⊖

Optional battery chargers

◇ Rapid charging with the BC-205 + BC-123S

The optional BC-205 with the BC-123S will provide rapid charging of the Li-ion battery pack.

(Charging time: approximately 2.5 hours)

- An AC adapter or the OPC-515/CP-23L DC power cable is additionally required, and may be supplied with BC-205, depending on the version.

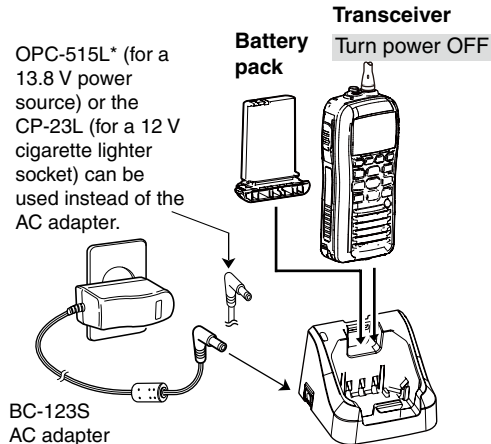

/// *CAUTION: NEVER connect the OPC-515L to a power source using reverse polarity. This will ruin the battery charger.

/// White line : ⊕ Black line : ⊖

◇ Rapid charging with the BC-197 + BC-157S or OPC-656

The optional BC-197 with the BC-157S will simultaneously charge up to 6 Li-ion battery packs. The following items are additionally required. (Charging time: approximately 2.5 hours)

- Six AD-124 charger adapters.
- The OPC-656 DC power cable.

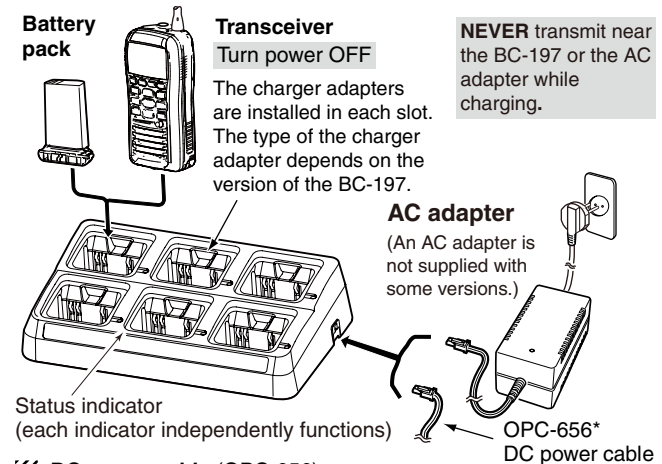

/// *DC power cable (OPC-656)
(Connect to a DC power supply: 12 to 16 V/at least 7 A)

/// NEVER reverse the polarity when connecting the power cable to a power source. This will ruin the battery charger.

/// Red line : ⊕ Black line : ⊖

11 BATTERY CHARGING

IMPORTANT: Battery charging caution

Ensure the slots on the battery pack are correctly aligned with the guide tabs inside the charger adapter.
(This is an illustration of the BC-204.)

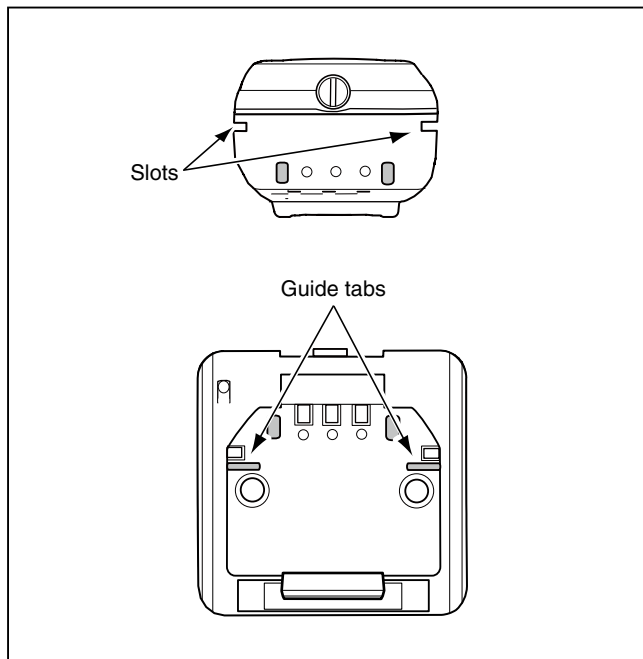

◇ Elastic strap attachment

Hold down the transceiver or battery pack, using an elastic strap* if necessary. This helps stabilize the battery pack or the transceiver in the charger in unstable situations. Follow the steps described below.

* Not supplied with the transceiver.

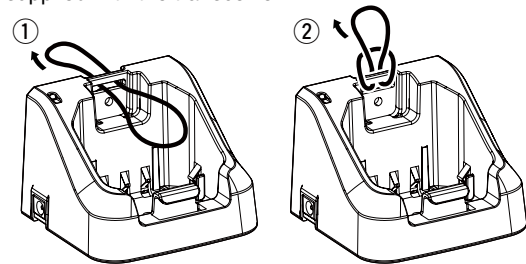

③ When charging, put the strap under the hook to securely hold down the transceiver or battery pack.

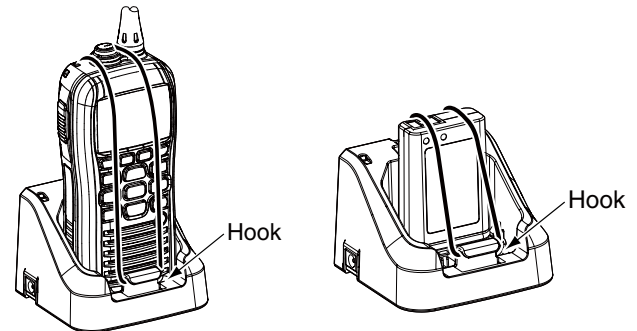

OPTIONAL SPEAKER-MICROPHONE 12

■ HM-167 descriptions

Alligator type clip

To attach the speaker-microphone to your shirt or collar, etc.

PTT switch

Push to transmit.
Release to receive.

Microphone

Speaker

Turn the transceiver power OFF when connecting the HM-167.

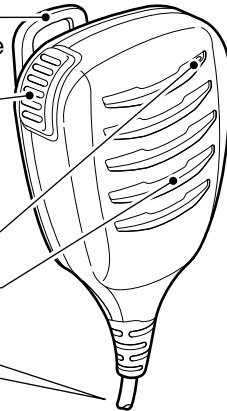

NEVER immerse the connector in water. If the connector becomes wet, be sure to dry it **BEFORE** attaching it to the transceiver.

NOTE: The microphone is located near the top of the speaker-microphone, as shown in the illustration above. To maximize the readability of your transmitted signal (voice), hold the microphone approximately 5 to 10 cm from your mouth, and speak at a normal voice level.

■ Attachment

Turn power OFF before attaching the speaker-microphone. Then, insert the speaker-microphone's connector into the [SP MIC] connector and carefully screw it tight, as shown in the diagram below. Be careful not to cross-thread the connection.

IMPORTANT: KEEP the transceiver's [SP MIC] cap attached when the speaker-microphone is not used. If the cover is not attached, water will get into the transceiver. Moreover, the terminals (pins) will become rusty, or the transceiver will function abnormally if the connector gets wet.

Set the triangle mark ▽ to the back side.

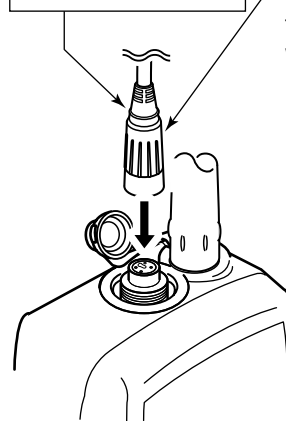

CAUTION: Attach the speaker-microphone's connector securely to prevent accidental dropping, or water intrusion in the connector.

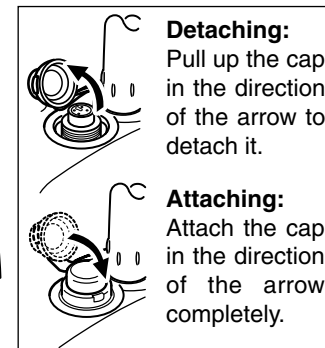

Detaching:

Pull up the cap in the direction of the arrow to detach it.

Attaching:

Attach the cap in the direction of the arrow completely.

11

12

13 TROUBLESHOOTING

PROBLEM	POSSIBLE CAUSE	SOLUTION	REF.
The transceiver does not turn ON.	<ul style="list-style-type: none"> • The Battery is exhausted or over discharged. • The Battery pack is not correctly attached. 	<ul style="list-style-type: none"> • Recharge the battery pack. • Correctly attach the battery pack. 	<p>p. 83</p> <p>p. 3</p>
Little or no sound comes from the speaker.	<ul style="list-style-type: none"> • The squelch level is set too high. • The volume level is set too low. • The speaker has been exposed to water. • Water has entered to [SP/MIC] connector. 	<ul style="list-style-type: none"> • Set the squelch to the threshold point. • Set the volume to a suitable level. • Remove the water with the AquaQuake function. • Dry [SP/MIC] connector 	<p>p. 14</p> <p>p. 16</p> <p>–</p>
Transmitting is impossible	<ul style="list-style-type: none"> • Some channels are programmed for low power or receive only by regulations. • The battery is exhausted. • The battery is overcharged. • The output power is set to low. 	<ul style="list-style-type: none"> • Change channels. • Recharge the battery pack. • Verify the battery voltage is correct. • Push [HI/LO] to select high power. 	<p>p. 12</p> <p>p. 83</p> <p>p. 14</p>
Scan does not start.	<ul style="list-style-type: none"> • Favorite channels are not programmed. 	<ul style="list-style-type: none"> • Set the desired channels as Favorite channels. 	p. 19
No beeps sound.	<ul style="list-style-type: none"> • Beep tones are turned OFF. 	<ul style="list-style-type: none"> • Turn the beep tones ON in the CONFIGURATION menu. 	p. 79
Distress calls cannot be transmitted.	<ul style="list-style-type: none"> • MMSI (DSC self ID) code is not programmed. 	<ul style="list-style-type: none"> • Program the MMSI (DSC self ID) code. 	p. 10

■ Specifications

◇ General

- Frequency coverage : Tx 156.000–161.450 MHz
Rx 156.000–163.425 MHz
- Mode : FM (16K0G3E), DSC (16K0G2B)
- Operating temperature range : –15°C to +55°C
- Current drain (approximately) : Tx (5 W) 1.5 A
Tx (1 W) 0.7 A
Tx (0.5 W) 0.6 A
Rx Max. audio 0.5 A
- Power supply requirement : 7.4 V DC nominal (negative ground)
- Frequency stability : ±1.5 kHz
- Antenna impedance : 50 Ω nominal
- Dimensions (approximately) : 61.2(W) × 141.4(H) × 43.2(D) mm
(Projections not included)
- Weight (approximately) : 287 g with BP-275

◇ Transmitter

- Output power : 5 W/1 W/0.5 W*
*German version only
- Modulation system : Variable reactance frequency modulation
- Max. frequency deviation : ±5 kHz
- Adjacent channel power : 70 dB
- Spurious emissions : 0.25 μW

Receiver

- Sensitivity (typical) : –4 dBμ emf at 20 dB SINAD
- Squelch sensitivity (threshold) : –5 dBμ emf (typical)
- Intermodulation rejection ratio : 68 dB
- Spurious response rejection ratio : 70 dB
- Adjacent channel selectivity : 70 dB
- Audio output power (at 10% distortion with an 8 Ω load) : 0.2 W (External)
0.7 W typical at 1 kHz (Internal)

All stated specifications are subject to change without notice or obligation.

14 SPECIFICATIONS AND OPTIONS

Options

• BP-275 Li-ion BATTERY PACK

Battery pack	Voltage	Capacity	Battery life*
BP-275	7.4 V	1500 mAh (min.) 1590 mAh (typ.)	8 hrs.

* The operating periods are calculated under the following conditions; TX : RX : Standby = 5 : 5 : 90

- **BC-204** REGULAR CHARGER + **BC-147S** AC ADAPTER
Used for regular charging of battery pack.
(Charging time: approximately 9 hours)
- **BC-205** RAPID CHARGER + **BC-123S** AC ADAPTER
For rapid charging of battery pack.
(Charging time: approximately 2.5 hours)
- **BC-197** RAPID CHARGER + **BC-157S** AC ADAPTER
For rapid charging of 6 battery packs.
(Charging time: approximately 2.5 hours)
- **OPC-515L/OPC-656** DC POWER CABLE
For charging of the battery packs using a 12 V DC power source instead of the AC adapter.
(OPC-515L for BC-204 and BC-205 : OPC-656 for BC-197)
- **HM-167** SPEAKER MICROPHONE
Full sized waterproof speaker-microphone including alligator type clip to attach to your shirt or collar.

• FA-SC59V ANTENNA

• MB-109 BELT CLIP

• MB-96F LEATHER BELT HANGER

• CP-23L/CP-25 CIGARETTE LIGHTER CABLE

For charging with the BC-204 or BC-205 charger through a 12 V cigarette lighter socket.

(CP-25 for BC-204 : CP-23L for BC-205)

NOTE:

The CP-23L is equipped with a 4 A fuse and the CP-25 with a 1 A fuse. If the fuses blow, replace them with new rated fuses.

DO NOT use fuses with amp ratings other than the ratings written above.

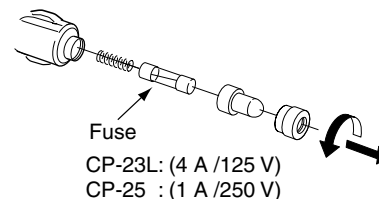

Approved Icom optional equipment is designed for optimal performance when used with an Icom transceiver. Icom is not responsible for the destruction or damage to an Icom transceiver in the event the Icom transceiver is used with equipment that is not manufactured or approved by Icom.

CHANNEL LIST 15

• International channels

CH	Frequency (MHz)		CH	Frequency (MHz)		CH	Frequency (MHz)		CH	Frequency (MHz)		CH	Frequency (MHz)		CH	Frequency (MHz)	
	Transmit	Receive		Transmit	Receive		Transmit	Receive		Transmit	Receive		Transmit	Receive		Transmit	Receive
01	156.050	160.650	11	156.550	156.550	21	157.050	161.650	61	156.075	160.675	71	156.575	156.575	81	157.075	161.675
02	156.100	160.700	12	156.600	156.600	22	157.100	161.700	62	156.125	160.725	72	156.625	156.625	82	157.125	161.725
03	156.150	160.750	13	156.650	156.650	23	157.150	161.750	63	156.175	160.775	73	156.675	156.675	83	157.175	161.775
04	156.200	160.800	14	156.700	156.700	24	157.200	161.800	64	156.225	160.825	74	156.725	156.725	84	157.225	161.825
05	156.250	160.850	15 ^{*2}	156.750	156.750	25	157.250	161.850	65	156.275	160.875	75 ^{*4}	156.775	156.775	85	157.275	161.875
06	156.300	156.300	16	156.800	156.800	26	157.300	161.900	66	156.325	160.925	76 ^{*4}	156.825	156.825	86	157.325	161.925
07	156.350	160.950	17 ^{*2}	156.850	156.850	27	157.350	161.950	67	156.375	156.375	77	156.875	156.875	87	157.375	157.375
08	156.400	156.400	18	156.900	161.500	28	157.400	162.000	68	156.425	156.425	78	156.925	161.525	88	157.425	157.425
09	156.450	156.450	19	156.950	161.550	37A ^{*3}	157.850	157.850	69	156.475	156.475	79	156.975	161.575	P4 ^{*3}	161.425	161.425
10	156.500	156.500	20	157.000	161.600	60	156.025	160.625	70 ^{*1}	156.525	156.525	80	157.025	161.625			

*1 DSC operation only.

*2 Channels 15 and 17 may also be used for on-board communications provided the effective radiated power does not exceed 1 W, and subject to the national regulations of the administration concerned when these channels are used in its territorial waters.

*3 UK Marina Channels: M1=37A (157.850 MHz), M2=P4 (161.425 MHz) for U.K. version only.

*4 The output power of channels 75 and 76 are limited to low power (1 W) only. The use of these channels should be restricted to navigation-related communications only and all precautions should be taken to avoid harmful interference to channel 16, e.g. by means geographical separation.

• USA channels (for U.K. version only)

CH	Frequency (MHz)		CH	Frequency (MHz)		CH	Frequency (MHz)		CH	Frequency (MHz)		CH	Frequency (MHz)		CH	Frequency (MHz)	
	Transmit	Receive		Transmit	Receive		Transmit	Receive		Transmit	Receive		Transmit	Receive		Transmit	Receive
01A	156.050	156.050	12	156.600	156.600	22A	157.100	157.100	64A	156.225	156.225	75 ^{*1}	156.775	156.775	85	157.275	161.875
--	---	---	13 ^{*1}	156.650	156.650	23A	157.150	157.150	65A	156.275	156.275	76 ^{*1}	156.825	156.825	85A	157.275	157.275
03A	156.150	156.150	14	156.700	156.700	24	157.200	161.800	66A	156.325	156.325	77 ^{*1}	156.875	156.875	86	157.325	161.925
--	---	---	15 ^{*1}	156.750	156.750	25	157.250	161.850	67 ^{*1}	156.375	156.375	78A	156.925	156.925	86A	157.325	157.325
05A	156.250	156.250	16	156.800	156.800	26	157.300	161.900	68	156.425	156.425	79A	156.975	156.975	87	157.375	161.975
06	156.300	156.300	17 ^{*1}	156.850	156.850	27	157.350	161.950	69	156.475	156.475	80A	157.025	157.025	87A	157.375	157.375
07A	156.350	156.350	18A	156.900	156.900	28	157.400	162.000	70 ^{*2}	156.525	156.525	81A	157.075	157.075	88	157.425	162.025
08	156.400	156.400	19A	156.950	156.950	37A ^{*3}	157.850	157.850	71	156.575	156.575	82A	157.125	157.125	88A	157.425	157.425
09	156.450	156.450	20	157.000	161.600	61A	156.075	156.075	72	156.625	156.625	83A	157.175	157.175	P4 ^{*3}	161.425	161.425
10	156.500	156.500	20A	157.000	157.000	--	---	---	73	156.675	156.675	84	157.225	161.825			
11	156.550	156.550	21A	157.050	157.050	63A	156.175	156.175	74	156.725	156.725	84A	157.225	157.225			

*1 Low power only. *2 DSC operation only. *3 UK Marina Channels: M1=37A (157.850 MHz), M2=P4 (161.425 MHz) for U.K. version only.

NOTE: Simplex channels, 3, 21, 23, 61, 64, 81, 82 and 83 **CANNOT** be lawfully used by the general public in U.S.A. waters.

Count on us!

< Intended Country of Use >											
<input type="checkbox"/> AT	<input type="checkbox"/> BE	<input type="checkbox"/> CY	<input type="checkbox"/> CZ	<input type="checkbox"/> DK	<input type="checkbox"/> EE						
<input type="checkbox"/> FI	<input type="checkbox"/> FR	<input type="checkbox"/> DE	<input type="checkbox"/> GR	<input type="checkbox"/> HU	<input type="checkbox"/> IE						
<input type="checkbox"/> IT	<input type="checkbox"/> LV	<input type="checkbox"/> LT	<input type="checkbox"/> LU	<input type="checkbox"/> MT	<input type="checkbox"/> NL						
<input type="checkbox"/> PL	<input type="checkbox"/> PT	<input type="checkbox"/> SK	<input type="checkbox"/> SI	<input type="checkbox"/> ES	<input type="checkbox"/> SE						
<input type="checkbox"/> GB	<input type="checkbox"/> IS	<input type="checkbox"/> LI	<input type="checkbox"/> NO	<input type="checkbox"/> CH	<input type="checkbox"/> BG						
<input type="checkbox"/> RO	<input type="checkbox"/> TR	<input type="checkbox"/> HR									

A-7024D-1EU
Printed in Japan
© 2012 Icom Inc.

Printed on recycled paper with soy ink.

Icom Inc.

1-1-32 Kamiminami, Hirano-ku, Osaka 547-0003, Japan