



INSTRUCTION MANUAL

VHF MARINE TRANSCEIVER

IC-M604A



Icom Inc.

Thank you for choosing this Icom product.

This product is designed and built with Icom's state of the art technology and craftsmanship. With proper care, this product should provide you with years of trouble-free operation.

◇ **FEATURES**

- *Built-in DSC meets ITU Class D requirement*
- *Front and rear panel microphone connection*
- *Optional COMMANDMICII™ (HM-157) and COMMANDMICIII™ (HM-162) are available and up to two COMMANDMIC™s can be connected*
- *Easy to make individual DSC Calls using Icom's MA-500TR Class B AIS Transponder*

Icom, Icom Inc. and the Icom logo are registered trademarks of Icom Incorporated (Japan) in Japan, the United States, the United Kingdom, Germany, France, Spain, Russia, Australia, New Zealand, and/or other countries. COMMANDMIC is a registered trademark of Icom Incorporated (Japan) in the United States.

IMPORTANT

READ ALL INSTRUCTIONS carefully and completely before using the transceiver.

SAVE THIS INSTRUCTION MANUAL — This instruction manual contains important operating instructions for the IC-M604A.

EXPLICIT DEFINITIONS

WORD	DEFINITION
⚠ WARNING!	Personal injury, fire hazard or electric shock may occur.
CAUTION	Equipment damage may occur.
NOTE	Recommended for optimum use. No risk of personal injury, fire or electric shock.

CLEAN THE TRANSCEIVER AND MICROPHONE THOROUGHLY WITH FRESH WATER after exposure to saltwater, and dry it before operating. Otherwise, the transceiver's keys, switches and controllers may become unusable, due to salt crystallization.

IN CASE OF EMERGENCY

If your vessel requires assistance, contact other vessels and the Coast Guard by sending a Distress call on Channel 16.

USING CHANNEL 16

DISTRESS CALL PROCEDURE

1. "MAYDAY MAYDAY MAYDAY"
2. "THIS IS" (name of vessel).
3. Say your call sign or other indication of the vessel (AND 9 digit DSC ID if you have one).
4. "LOCATED AT" (your position).
5. State the nature of the distress and assistance required.
6. Give any other information which might facilitate the rescue.

Or, transmit your Distress call using digital selective calling on Channel 70.

USING DIGITAL SELECTIVE CALLING (Ch 70)

DISTRESS CALL PROCEDURE

1. While lifting up the key cover, hold down **[DISTRESS]** for 5 seconds until you hear 5 short beeps change to one long beep.
2. Wait for an acknowledgment on Channel 70 from a coast station.
 - After the acknowledgement is received, Channel 16 is automatically selected.
3. Hold down **[PTT]**, then transmit the appropriate information as listed above.

NOTE

A WARNING STICKER is supplied with the transceiver. To comply with FCC regulations, this sticker must be affixed in such a location as to be readily seen from the operating controls of the radio as in the diagram below. Make sure the chosen location is clean and dry before applying the sticker.

EXAMPLE



RADIO OPERATOR WARNING



Icom requires the radio operator to meet the FCC requirements for radio frequency exposure. An omnidirectional antenna with gain not greater than 9 dBi must be mounted a minimum of 5 meters (measured from the lowest point of the antenna) vertically above the main deck and all possible personnel. This is the minimum safe separation distance estimated to meet all RF exposure compliance requirements. This 5 meter distance is based on the FCC Safe Maximum Permissible Exposure (MPE) distance of 3 meters added to the height of an adult (2 meters) and is appropriate for all vessels.

For watercraft without suitable structures, the antenna must be mounted so as to maintain a minimum of 1 meter vertically between the antenna, (measured from the lowest point of the antenna), to the heads of all persons AND all persons must stay outside of the 3 meter MPE radius.

Do not transmit with radio and antenna when persons are within the MPE radius of the antenna, unless such persons (such as driver or radio operator) are shielded from antenna field by a grounded metallic barrier. The MPE radius is the minimum distance from the antenna axis that person should maintain in order to avoid RF exposure higher than the allowable MPE level set by FCC.

FAILURE TO OBSERVE THESE LIMITS MAY ALLOW THOSE WITHIN THE MPE RADIUS TO EXPERIENCE RF RADIATION ABSORPTION WHICH EXCEEDS THE FCC MAXIMUM PERMISSIBLE EXPOSURE (MPE) LIMIT. IT IS THE RESPONSIBILITY OF THE RADIO OPERATOR TO ENSURE THAT THE MAXIMUM PERMISSIBLE EXPOSURE LIMITS ARE OBSERVED AT ALL TIMES DURING RADIO TRANSMISSION. THE RADIO OPERATOR IS TO ENSURE THAT NO BYSTANDERS COME WITHIN THE RADIUS OF THE MAXIMUM PERMISSIBLE EXPOSURE LIMITS.

Determining MPE Radius

THE MAXIMUM PERMISSIBLE EXPOSURE (MPE) RADIUS HAS BEEN ESTIMATED TO BE A RADIUS OF ABOUT 3M PER OET BULLETIN 65 OF THE FCC. THIS ESTIMATE IS MADE ASSUMING THE MAXIMUM POWER OF THE RADIO AND ANTENNAS WITH A MAXIMUM GAIN OF 9dBi ARE USED FOR A SHIP MOUNTED SYSTEM.

TABLE OF CONTENTS

IMPORTANT	i
EXPLICIT DEFINITIONS	i
IN CASE OF EMERGENCY	ii
NOTE	ii
RADIO OPERATOR WARNING	iii
PRECAUTIONS	v
1 OPERATING RULES	1
2 PANEL DESCRIPTION	2-6
■ Panel description	2
■ Function display	4
■ Speaker microphone	6
3 BASIC OPERATION	7-12
■ Channel selection	7
■ Receiving and transmitting	9
■ Call channel programming	10
■ Microphone lock function	10
■ Display backlight	10
■ Channel comments	11
■ AquaQuake water draining function	11
■ Optional Voice scrambler operation	12
4 DUALWATCH/TRI-WATCH	13
■ Description	13
■ Operation	13
5 SCAN OPERATION	14-15
■ Scan types	14
■ Setting TAG channels	15
■ Starting a scan	15
6 DSC OPERATION	16-38
■ MMSI code programming	16
■ DSC address ID	16

■ Position and Time programming	18
■ Position and Time display	19
■ GPS information display	19
■ Distress call	20
■ Transmitting DSC Calls	23
■ Receiving DSC Calls	34
■ Received messages	40
■ DSC Set mode	41
7 OTHER FUNCTIONS	43-46
■ Intercom operation	43
■ Hailer operation	44
■ Automatic foghorn	45
■ RX speaker function	46
8 SET MODE	47-49
■ Set mode programming	47
■ Set mode items	47
9 CONNECTIONS AND MAINTENANCE	50-57
■ Connections	50
■ Fuse replacement	51
■ Supplied accessories	51
■ Antenna	51
■ Mounting the transceiver	52
■ MB-75 installation	53
■ UT-112/UT-98 installation	54
■ HM-157/HM-162 installation	55
10 TROUBLESHOOTING	58
11 SPECIFICATIONS AND OPTIONS	59-60
■ Specifications.....	59
■ Options	60
12 CHANNEL LIST	61



PRECAUTIONS

⚠ **WARNING! NEVER** connect the transceiver to an AC outlet. This may pose a fire hazard or result in an electric shock.

⚠ **WARNING! NEVER** connect the transceiver to a power source of more than 16 V DC or use reverse polarity. This will ruin the transceiver.

⚠ **WARNING! NEVER** cut the DC power cable between the DC plug at the back of the transceiver and fuse holder. If an incorrect connection is made after cutting, the transceiver may be damaged.

⚠ **WARNING! NEVER** operate the transceiver during a lightning storm. It may result in an electric shock, cause a fire or damage the transceiver. Always disconnect the power source and antenna before a storm.

CAUTION: NEVER place the transceiver where normal operation of the vessel may be hindered or where it could cause bodily injury.

CAUTION: Changes or modifications to this device, not expressly approved by Icom Inc., could void your authority to operate this device under FCC regulations.

KEEP the transceiver and microphone at least 1 m (3.3 ft) away from the vessel's magnetic navigation compass.

DO NOT operate or place the transceiver in areas with temperatures below -20°C (-4°F) or above $+60^{\circ}\text{C}$ ($+140^{\circ}\text{F}$) or, in areas subject to direct sunlight, such as the dashboard.

DO NOT use harsh solvents such as benzine or alcohol to clean the transceiver, as they will damage the transceiver's surfaces. If the transceiver becomes dusty or dirty, wipe it clean with a soft, dry cloth.

BE CAREFUL! The transceiver rear panel will become hot when operating continuously for long periods of time.

Place the transceiver in a secure place to avoid inadvertent use by children.

BE CAREFUL! The transceiver and the optional HM-157 COMMANDMICII™/HM-162* COMMANDMICIII™ employ waterproof construction, which corresponds to IPX7. However, once the transceiver or microphone has been dropped, waterproof protection cannot be guaranteed because of possible damage to the transceiver's or microphone's case or the waterproof seal.

* Equivalent to IPX8

Icom is not responsible for the destruction or damage to the Icom transceiver, if the malfunction is because of:

- Force majeure, including, but not limited to, fires, earthquakes, storms, floods, lightning, other natural disasters, disturbances, riots, war, or radioactive contamination.
- The use of Icom transceivers with any equipment that is not manufactured or approved by Icom.

◇ Priorities

- Read all rules and regulations pertaining to call priorities, and keep an up-to-date copy handy. Safety and distress calls take priority over all others.
- You must monitor Channel 16 when you are not operating on another channel.
- False or fraudulent distress calls are prohibited under law.

◇ Privacy

- Information overheard, but not intended for you, cannot lawfully be used in any way.
- Indecent or profane language is prohibited.

◇ Radio licenses

(1) SHIP STATION LICENSE

You may require a current radio station license before using the transceiver. It is unlawful to operate a ship station which is not licensed, but required to be.

If required, contact your dealer or the appropriate government agency for a Ship-Radiotelephone license application. This government-issued license states the call sign which is your craft's identification for radio purposes.

(2) OPERATOR'S LICENSE

A Restricted Radiotelephone Operator Permit is the license most often held by small vessel radio operators when a radio is not required for safety purposes.

If required, the Restricted Radiotelephone Operator Permit must be posted or kept with the operator. If required, only a licensed radio operator may operate a transceiver.

However, non-licensed individuals may talk over a transceiver if a licensed operator starts, supervises, ends the call and makes the necessary log entries.

A current copy of the applicable government rules and regulations is only required to be on hand for vessels in which a radio telephone is compulsory. However, even if you are not required to have these on hand it is your responsibility to be thoroughly acquainted with all pertinent rules and regulations.

NOTE: Even though the IC-M604A is capable of operation on VHF marine channels 3, 21, 23, 61, 64, 81, 82 and 83, according to FCC regulations these simplex channels cannot be lawfully used by the general population in USA waters.

■ Panel description

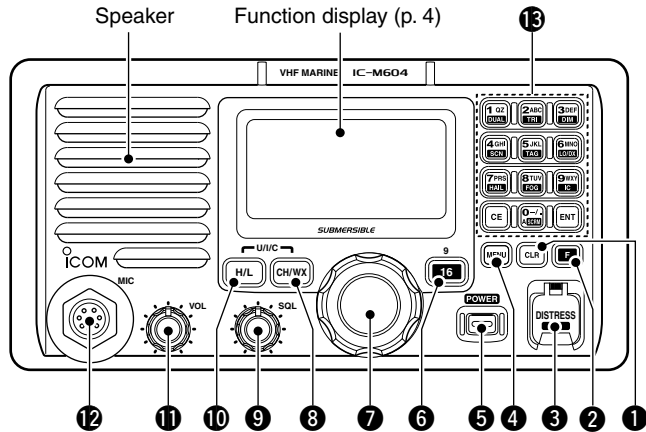

1 CLEAR KEY [CLR]

Push to cancel the entered function, exit the Set mode. (p. 47)

2 FUNCTION KEY [F]

After pushing this key, some keys perform a secondary functions.

- “F” is displayed when a secondary function can be accessed.

3 DISTRESS KEY [DISTRESS] (pp. 20, 22)

Hold down for 5 seconds to transmit a Distress call.

4 DSC MENU KEY [MENU] (p. 16)

Push to toggle the DSC menu ON or OFF.

5 POWER KEY [POWER] (p. 9)

- ➔ Push to turn ON the transceiver.
- ➔ Hold down for 1 second to turn OFF the transceiver.

6 CHANNEL 16/CALL CHANNEL KEY [16•9]

- ➔ Push to select Channel 16. (p. 7)
- ➔ Hold down for 1 second to select the Call channel. (p. 7)
 - “CALL” is displayed when the Call channel is selected.
- ➔ Hold down for 3 seconds to enter Call channel programming mode when the Call channel is selected. (p. 10)
- ➔ While holding down [H/L], push to enter channel comments programming mode. (p. 11)
- ➔ While turning ON the transceiver, push to enter Set mode. (p. 43)

7 SELECTOR DIAL [SELECTOR] (pp. 7–9)

Rotate to select the operating channels, set mode contents, and so on.

8 CHANNEL/WEATHER CHANNEL KEY [CH/WX]

- ➔ When pushed momentarily, selects and toggles the regular channels and weather channels. (p. 8)
- ➔ While holding down [H/L], push to sequentially select one of three channel groups. (p. 8)
 - USA, International and Canadian channel groups are selectable.

9 SQUELCH CONTROL [SQL] (p. 9)

Rotate to set the squelch threshold level.

10 TRANSMIT POWER KEY [H/L]

- ➔ Push to toggle the output power high or low. (p. 9)
 - Some channels are set to only low power.
- ➔ While holding down this key, some keys perform secondary functions.

11 VOLUME CONTROL [VOL] (p. 9)

Rotate to adjust the audio level.

12 MIC CONNECTOR

Connect only the supplied microphone.

CAUTION: NEVER connect another microphone here, such as the optional COMMANDMIC™s. It may cause damage to the transceiver.

13 KEYPAD

- ➔ Inputs numbers for channel number input, and so on.
 - After inputting the desired channel number, then push [ENT].
 - Hold down [0•A] to input 'A' for simplex channels.
- ➔ Inputs numbers, letters and some symbols for channel comment input.
- ➔ After pushing [F], push to perform the secondary function.
 - Most of the secondary functions (except TAG channel setting, Attenuator, RX speaker and Auto foghorn functions) can be cleared or cancelled when [CLR] is pushed.



- ➔ Number input: '1'
- ➔ Comment input: '1,' 'Q,' 'Z,' 'q,' 'z' or space
- ➔ After pushing [F], push to turn the Dualwatch function ON or OFF. (p. 13)



- ➔ Number input: '2'
- ➔ Comment input: '2,' 'A,' 'B,' 'C,' 'a,' 'b' or 'c'
- ➔ After pushing [F], push to turn the Tri-watch function ON or OFF. (p. 13)



- ➔ Number input: '3'
- ➔ Comment input: '3,' 'D,' 'E,' 'F,' 'd,' 'e' or 'f'
- ➔ After pushing [F], push this key then rotate [SELECTOR] to adjust the LCD and key backlight brightness. (p. 10)



- ➔ Number input: '4'
- ➔ Comment input: '4,' 'G,' 'H,' 'I,' 'g,' 'h' or 'i'
- ➔ After pushing [F], push to start or stop a scan. (p. 15)



- ➔ Number input: '5'
- ➔ Comment input: '5,' 'J,' 'K,' 'L,' 'j,' 'k' or 'l'
- ➔ After pushing [F], push to set the displayed channel as a TAG channel. (p. 15)
- ➔ While holding down [H/L], push for 3 seconds to clear or set all TAG channels. (p. 15)



- ➔ Number input: '6'
- ➔ Comment input: '6,' 'M,' 'N,' 'O,' 'm,' 'n' or 'o'
- ➔ After pushing [F], push to turn the Attenuator ON or OFF. (p. 9)
 - "LOC" is displayed when the Attenuator is activated.

2 PANEL DESCRIPTION

■ Panel description (Continued)



- ➔ Number input: '7'
- ➔ Comment input: '7,' 'P,' 'R,' 'S,' 'p,' 'r' or 's'
- ➔ After pushing [7], push to turn the Hailer function ON or OFF. (p. 44)
- ➔ After pushing [7], hold down for 1 second to turn the RX speaker function ON or OFF. (p. 46)



- ➔ Number input: '8'
- ➔ Comment input: '8,' 'T,' 'U,' 'V,' 't,' 'u' or 'v'
- ➔ After pushing [8], push to turn the Automatic foghorn function ON or OFF. (p. 45)



- ➔ Number input: '9'
- ➔ Comment input: '9,' 'W,' 'X,' 'Y,' 'w,' 'x' or 'y'
- ➔ After pushing [9], push to turn the Intercom function ON or OFF. (p. 43)



- ➔ Number input: '0'
- ➔ Number input: Hold down for 1 second to input the character 'A' for simplex channel.
- ➔ Comment input: '0' and symbols ('-' '/' ':')
- ➔ After pushing [0], push to activate an optional Voice scrambler function. (p. 12)
 - The optional Voice scrambler function cannot be used on Channels 16 and 70.



- ➔ Push to enter the input channel comment, selected item, and so on.



- ➔ Push to clear the entered data.

■ Function display

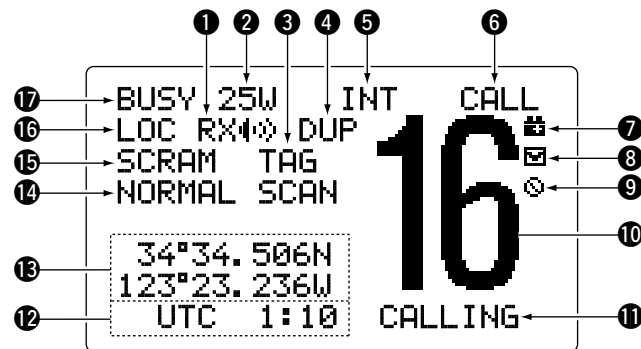

- ① **RX SPEAKER ICON** (p. 46)
Displayed when in the RX speaker mode.
- ② **POWER ICON** (p. 9)
 - ➔ "25W" is displayed when high power is selected.
 - ➔ "1W" is displayed when low power is selected.
- ③ **TAG CHANNEL ICON** (p. 15)
Displayed when a TAG channel is selected.
- ④ **DUPLEX ICON** (p. 8)
Displayed when a duplex channel is selected.
- ⑤ **CHANNEL GROUP ICON** (p. 8)
Indicates whether a USA "USA," International "INT," Canadian "CAN" or weather "WX" channel is in use.

6 CALL CHANNEL ICON (pp. 7, 10)

Displayed when the Call channel is selected.

7 LOW BATTERY ICON

Blinks when the battery voltage drops to approximately 10 V DC or less.

8 MAIL ICON

Blinks when there is a message which has not been read. (P. 40)

9 Auto SW ICON

Blinks when both the Auto SW function and Auto Tune timer are turned OFF. (P. 39)

10 CHANNEL NUMBER READOUT

Displays the selected operating channel number.

11 CHANNEL COMMENT INDICATOR

Channel comments are displayed if programmed. (p. 11)

12 TIME ZONE INDICATOR

- ➔ Displays the current time data when a GPS receiver is connected, or the time data is manually programmed.
 - When the GPS current time data is invalid, “??” may blink every 2 seconds instead of current time data. After 23.5 hours have passed, “No Time” will be displayed.
 - “??” may blink every 2 seconds instead of current time data, after 4 hours have passed from the time when the time data was manually programmed. The manually programmed time data is held for only 23.5 hours, and after that, “No Time” will be displayed.
- ➔ “Local” is displayed when the offset time data is set. (p. 42)
- ➔ “No Time” is displayed when no GPS receiver is connected and no time data is manually input.

13 POSITION INDICATOR

- ➔ Displays the current position data when a GPS receiver is connected, or the time data is manually programmed.
 - When the GPS current time data is invalid, “??” may blink every 2 seconds instead of position data. The last position data is held for only 23.5 hours, and after that, “No Position” will be displayed.
 - “??” may blink every 2 seconds instead of data, after 4 hours have passed from the time when the time data is manually programmed. The manually programmed position data is held for only 23.5 hours, and after that, “No Position” will be displayed.
- ➔ “No Position” is displayed when no GPS receiver is connected and no position data is manually input.

14 SCAN INDICATOR

- ➔ “PRI-SCAN 16” is displayed during Priority scan; “NORMAL SCAN” is displayed during Normal scan. (p. 15)
- ➔ “DUAL 16” is displayed during Dualwatch; “TRI 16” is displayed during Tri-watch. (p. 13)

15 SCRAMBLER ICON (p. 12)

Displayed when the voice scrambler function is turned ON. (only when the optional scrambler unit is installed.)

16 LOCAL ICON (p. 9)

Displayed when the Attenuator function is turned ON.

17 BUSY/TRANSMIT ICON (p. 9)

- ➔ “BUSY” is displayed when receiving a signal or when the squelch opens.
- ➔ “TX” is displayed while transmitting.

2 PANEL DESCRIPTION

■ Speaker microphone

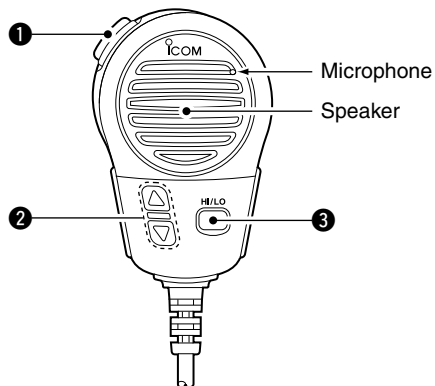

① PTT SWITCH [PTT]

Hold down to transmit, release to receive. (p. 9)

② CHANNEL UP/DOWN KEYS [▲]/[▼]

- ➔ Push either key to change the operating channels, Set mode settings, and so on. (pp. 7–9, 47)
- ➔ Checks TAG channels, changes scanning direction or manually resumes a scan. (p. 15)

③ TRANSMIT POWER KEY [HI/LO]

- ➔ Push to toggle the power high and low. (p. 9)
 - Some channels are set to only low power.
- ➔ While holding down [HI/LO], turn ON the transceiver to turn the Microphone lock function ON or OFF. (p. 10)

■ Channel selection

◇ Channel 16

Channel 16 is the distress and safety channel. It is used for establishing initial contact with a station and for emergency communications. Channel 16 is monitored during both Dualwatch and Tri-watch. While standing by, you must monitor Channel 16.

- Push **[16•9]** momentarily to select Channel 16.
- Push **[CH/WX]** to return to the screen before selecting Channel 16, or rotate **[SELECTOR]** to select a channel.
 - Pushing the keypad keys, or **[▲]/[▼]** on the microphone, also selects a channel.

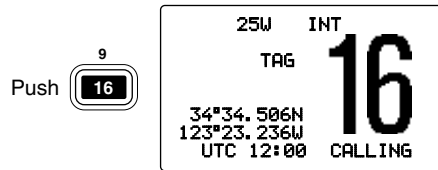

✓ *Convenient!*

When the Favorite channel function is turned ON (p. 49), pushing the **[▲]/[▼]** keys on the microphone sequentially selects the favorite channels in the selected channel group.

- The favorite channels are set by the TAG channel setting. (p. 15)

◇ Channel 9 (Call channel)

Each regular channel group has a separate leisure-use Call channel. The Call channel is monitored during Tri-watch. The Call channels can be programmed, and are used to store your most often used channel in each channel group for quick recall. (p. 10)

- Hold down **[16•9]** for 1 second to select the Call channel of the selected channel group.
 - “CALL” and Call channel number are displayed.
 - Each channel group may have an independent Call channel after programming a Call channel. (p. 10)
- Push **[CH/WX]** to return to the screen before you selected Call channel, or rotate **[SELECTOR]** to select a channel.
 - Pushing keys on the keypad, or **[▲]/[▼]** on the microphone, also selects a channel.

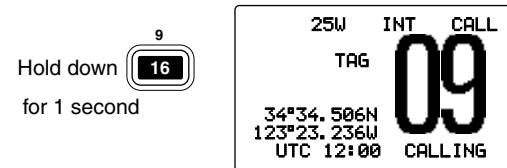

3 BASIC OPERATION

■ Channel selection (Continued)

◇ USA, International and Canadian channels

The IC-M604A is preset with 59 USA, 59 international and 63 Canadian channels. These channel groups may be set for your operating area.

- ① Push **[CH/WX]** to select a regular channel.
 - If a weather channel is displayed, push **[CH/WX]** again.
- ② While holding down **[H/L]**, push **[CH/WX]** to change the channel group, if necessary.
 - USA, International and Canadian channel groups can be sequentially selected.
- ③ Rotate **[SELECTOR]** to select a channel.
 - “DUP” is displayed for duplex channels.
 - “A” is displayed when a simplex channel is selected.
 - Pushing the keypad keys, or **[▲]/[▼]** on the microphone, also selects a channel.

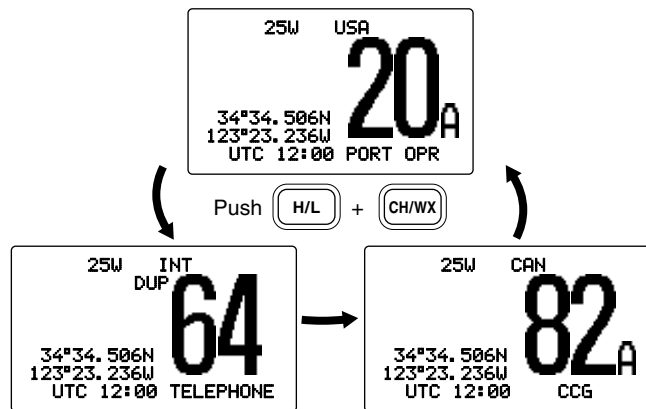

◇ Weather channels

The IC-M604A has 10 weather channels. These are used for monitoring broadcasts from NOAA (National Oceanographic and Atmospheric Administration.)

The transceiver can automatically detect a weather alert tone on the selected weather channel while receiving on another channel, during standby on a regular channel or while scanning. (p. 48)

- ① Push **[CH/WX]** once or twice to select a weather channel.
 - “WX” is displayed when a weather channel is selected.
 - “WX ALERT” is displayed when the weather alert function is turned ON. (p. 48)
- ② Rotate **[SELECTOR]** to select a channel.
 - Pushing the keypad keys, or **[▲]/[▼]** on the microphone, also selects a channel.

Push **[CH/WX]** once or twice

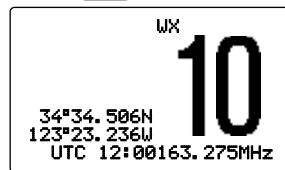

Weather alert is OFF.

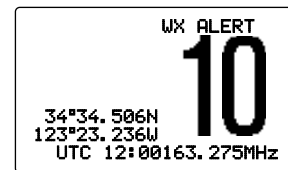

Weather alert is ON.

■ Receiving and transmitting

CAUTION: Transmitting without an antenna will damage the transceiver.

- ① Push **[POWER]** to turn ON the transceiver.
- ② Set the audio and squelch levels.
 - ➔ Rotate **[SQL]** fully counterclockwise first.
 - ➔ Rotate **[VOL]** to adjust the audio output level.
 - ➔ Rotate **[SQL]** clockwise until the noise disappears.
- ③ While holding down **[H/L]**, push **[CH/WX]** several times to change the channel group. (p. 8)
- ④ Rotate **[SELECTOR]** to select a channel. (pp. 6, 7, 61)
 - Pushing the keypad keys, or **[▲]/[▼]** on the microphone, also selects a channel.
 - When receiving a signal, “BUSY” is displayed and audio is heard from the speaker.
 - You may need to further adjust **[VOL]**.
- ⑤ Push **[A]**, then push **[6•LO/DX]** to turn the receive Attenuator function ON or OFF, if necessary.
 - “LOC” is displayed when the receive Attenuator is ON.
- ⑥ Push **[H/L]** to select the output power, if necessary.
 - “25W” or “1W” is displayed when high or low power is selected.
 - Choose low power for short range communications, choose high power for longer distance communications.
 - Some channels are restricted to only low power.
- ⑦ Hold down **[PTT]** to transmit, then speak into the microphone at your normal voice level.
 - “TX” is displayed.
 - Channel 70 cannot be used for transmission other than DSC.
- ⑧ Release **[PTT]** to receive.

Simplex channels, 3, 21, 23, 61, 64, 81, 82 and 83 **CANNOT** be lawfully used by the general public in USA waters.

IMPORTANT: To maximize the readability of your transmitted signal, pause a few seconds after pushing **[PTT]**, hold the microphone 5 to 10 cm (2 to 4 inches) from your mouth and speak at a normal voice level.

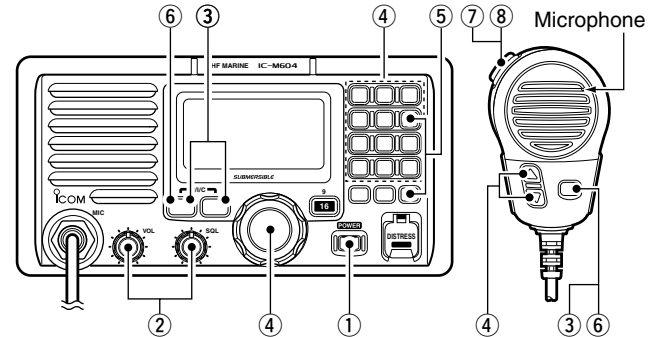

✓ NOTE for Time-out Timer (TOT) function

The TOT function inhibits continuous transmission over a preset period of time after the transmission starts. 10 seconds before the TOT function activates, a beep sounds to indicate the transmission will be shut down and “TOT” is displayed on the channel comment indicator. Transmission is not possible for 10 seconds after this transmission shut down.

3 BASIC OPERATION

■ Call channel programming

The Call channel is used to select Channel 9 (default), however, you can program the Call channel with your most often-used channels in each channel group for quick recall.

- ① While holding down **[H/L]**, push **[CH/WX]** several times to select the desired channel group (USA, International or Canada) to be programmed.
- ② Hold down **[16•9]** for 1 second to select the Call channel of the selected channel group.
 - “CALL” and the Call channel number are displayed.
- ③ Hold down **[16•9]** again for 3 seconds (until a long beep changes to 2 short beeps) to enter the Call channel programming mode.
 - Channel number starts blinking.
- ④ Rotate **[SELECTOR]** to select the desired channel.
- ⑤ Push **[16•9]** to program the displayed channel as the Call channel.
 - Push **[CLR]** to cancel.
 - The channel number stops blinking.

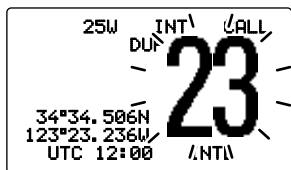
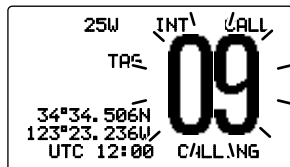

■ Microphone lock function

The Microphone lock function electrically locks **[▲]/[▼]** and **[HI/LO]** keys on the supplied microphone. This prevents accidental channel changes and function access.

- While holding down **[HI/LO]** on the microphone, turn ON the power to turn the Microphone lock function ON or OFF.

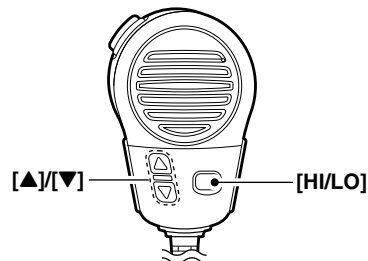

■ Display backlight

The function display and keys can be backlit for better visibility under low light conditions.

- After pushing **[E]**, push **[3•DIM]** then rotate **[SELECTOR]** to adjust the brightness of the LCD and key backlight, then push **[ENT]**.
 - The backlight is adjustable in 7 levels, or set to OFF.

■ Channel comments

Each channel can be labeled with a unique alphanumeric ID of up to 10 characters.

Capital letters, small letters, 0 to 9, some symbols (- . /) and space can be used.

- ① Select the desired channel.
 - Cancel Dualwatch, Tri-watch or Scan first.
 - ② While holding down **[H/L]**, push **[16•9]** to edit the channel comment.
 - A cursor and the first character start alternately blinking.
- 25W INT

71

34°34.506N
123°23.236W /
UTC 12:00 MEASURE...
- ③ Push the appropriate key several times to select the desired character.
 - See the table to the right for selectable characters.
 - Rotate **[SELECTOR]** or push **[▲]/[▼]** on the microphone to move the cursor.
 - Push **[CE]** to clear the channel comment.
 - Push **[CLR]** to cancel and exit the screen.
 - ④ Push **[ENT]** to input and set the comment.
 - The cursor and the character stop blinking.
 - ⑤ Repeat steps ① to ④ to program other channel comments, if desired.

• Selectable characters

KEY	CHARACTERS	KEY	CHARACTERS
1 QZ DUAL	1 Q Z q z (space)	6 MNO LOIDX	6 M N O m n o
2 ABC TRI	2 A B C a b c	7 PRS HAL	7 P R S p r s
3 DEF DIM	3 D E F d e f	8 TUV FOG	8 T U V t u v
4 GHI SCN	4 G H I g h i	9 WXY IC	9 W X Y w x y
5 JKL TAG	5 J K L j k l	0 - / . ASCRM	0 - / .

■ AquaQuake water draining function

The IC-M604A uses a new technology to clear water away from the speaker grill: AquaQuake. AquaQuake helps clear water away from the speaker housing (water that might otherwise muffle the sound coming from the speaker). The IC-M604A emits a vibrating noise when this function is being used.

- While holding down **[H/L]**, turn ON the transceiver.
 - A low beep tone sounds while **[H/L]** key is pushed and held to drain water, regardless of **[VOL]** control setting.
 - All other key operations are disabled while the AquaQuake function is activated.

/// To clear water away from the HM-162, hold down **[PTT]**, and then turn ON the transceiver.

3 BASIC OPERATION

■ Optional Voice scrambler operation

◇ Activating the scrambler function

The optional Voice scrambler provides private communications. In order to receive or send scrambled transmissions you must first activate the scrambler function. To activate the function, an optional scrambler unit is necessary. See pages 49 and 54 for setting and installation of the scrambler unit. Ask your dealer for details.

/// The scrambler function automatically turns OFF when
/// Channel 16 or 70 is selected.

- ① Rotate **[SELECTOR]** to select the desired channel other than Channel 16 and 70.
- ② Push **[F]**, then push **[0•SCRM]** to turn the Voice scrambler function ON.
 - “SCRAM” is displayed.
- ③ To turn OFF the scrambler function, repeat step ②.
 - “SCRAM” disappears.

◇ Programming scrambler codes

There are 32 codes (1 to 32) or 128 codes (0 to 127)* selectable for programming when an optional scrambler unit is installed. In order to understand one another, all transceivers in your group must have the same scramble code. This function may not be available depending on the dealer setting.

*Depending on the installed scrambler unit.

- ① Push **[POWER]** to turn OFF the transceiver. Hold down **[16•9]**, and push **[POWER]** to enter Set mode.
- ② After the Set mode screen is displayed, release **[16•9]**.
- ③ Rotate **[SELECTOR]** to select the “Scrambler Code,” then push **[ENT]**.
- ④ Rotate **[SELECTOR]** to select the desired scrambler code.
- ⑤ Push **[ENT]** to set and exit the scrambler code item.
- ⑥ Push **[CLR]**, or rotate **[SELECTOR]** to select “Exit,” then push **[ENT]** to exit the Set mode.

[Example]: Programming scrambler code 8.

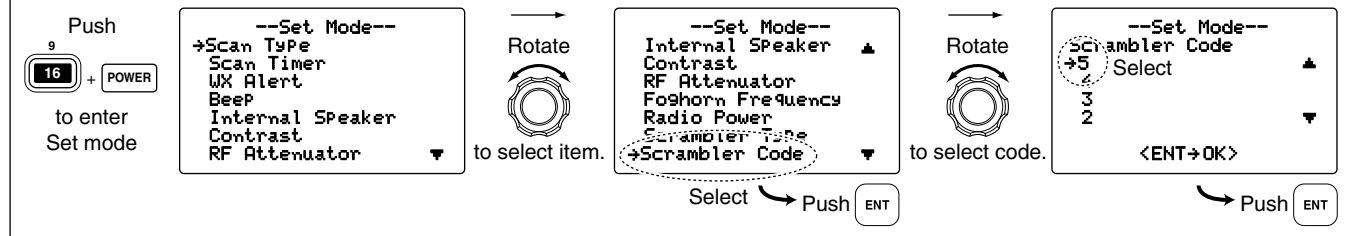

■ Description

Dualwatch monitors Channel 16 while you are receiving on another channel; Tri-watch monitors Channel 16 and the Call channel while receiving another channel. Dualwatch and Tri-watch are both convenient for monitoring Channel 16 when you are operating on another channel.

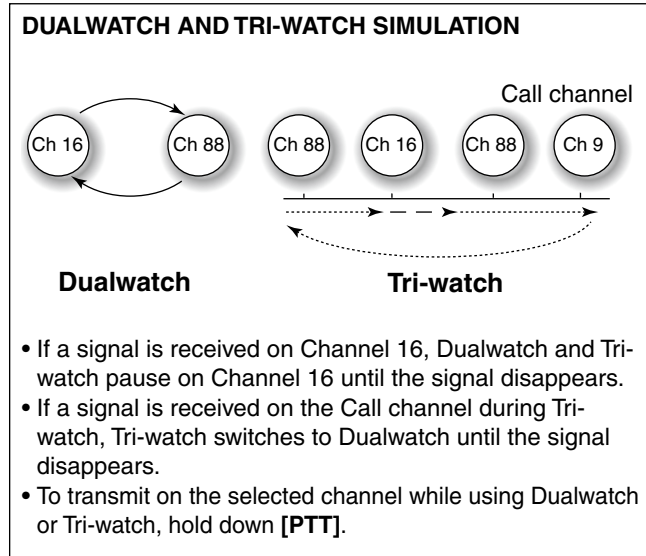

■ Operation

- ① Select the desired channel.
- ② Push [F], then push [1•DUAL] to start Dualwatch or [2•TRI] to start Tri-watch.
 - "DUAL 16" is displayed during Dualwatch; "TRI 16" is displayed during Tri-watch.
 - A beep tone sounds when a signal is received on Channel 16.
- ③ To cancel Dualwatch or Tri-watch, push [CLR] or repeat step ②.

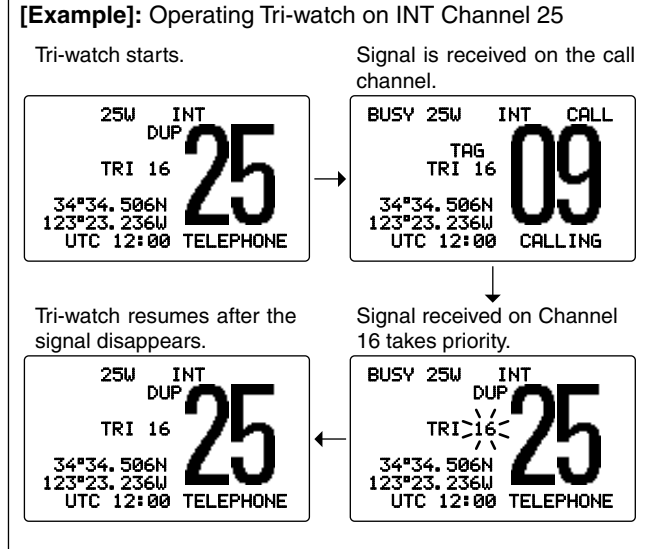

■ Scan types

Scanning is an efficient way to locate signals quickly over a wide frequency range. The transceiver has Priority scan and Normal scan.

When the Weather alert function is turned ON, the previously selected (last used) weather channel is also checked while scanning. (p. 48)

PRIORITY SCAN

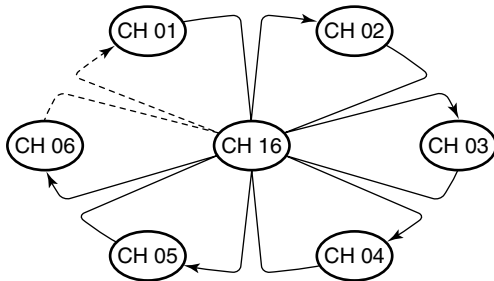

Priority scan sequentially searches through all TAG channels while monitoring Channel 16. When a signal is detected on Channel 16, the scan pauses until the signal disappears; when a signal is detected on a channel other than Channel 16, the scan switches to Dualwatch until the signal disappears.

Set the TAG channels (scanned channel) before scanning. Clear the TAG channels which inconveniently stop scanning, such as those for digital communication use. (Refer to the right page for details.)

∕∕ Choose Priority or Normal scan in the Set mode. (p. 47)

NORMAL SCAN

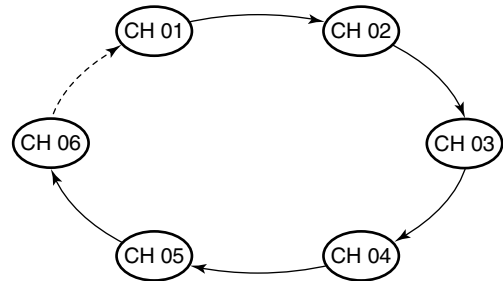

Normal scan, like priority scan, sequentially searches through all TAG channels. However, unlike priority scan, Channel 16 is not checked unless it is set as a TAG channel.

■ Setting TAG channels

For more efficient scanning, add the desired channels as TAG channels, or clear the TAG of unwanted channels. Channels that are not tagged will be skipped while scanning. TAG channels can be independently assigned to each channel group (USA, International and Canada).

- ① While holding down [H/L], push [CH/WX] several times to select the desired channel group.
- ② Select the desired channel to be set as a TAG channel.
- ③ Push [F], then push [5•TAG] to set the displayed channel as a TAG channel.
 - “TAG” is displayed on the screen.
- ④ To cancel the TAG channel setting, repeat step ③.
 - “TAG” disappears.

Clearing (or setting) all tagged channels

To clear all TAG channels setting in the selected channel group while holding down [H/L], push [5•TAG] for 3 seconds (until a long beep changes to 2 short beeps).

- Repeat the above procedure to set all channels in the group as TAG channels.

■ Starting a scan

First, set the Priority or Normal scan type, and the scan resume timer in the Set mode. (p. 47)

- ① To start a scan, while holding down [H/L], push [CH/WX] several times to select the channel group, if desired.
- ② Set TAG channels as described to the left.
- ③ Make sure the squelch is closed to start a scan.
- ④ Push [F], then push [4•SCAN] to start a Priority or Normal scan.
 - “PRI-SCAN 16” or “NORMAL SCAN” is displayed on the screen.
 - When a signal is detected, the scan pauses until the signal disappears or resumes after pausing 5 seconds, depending on the Set mode setting. (Channel 16 is still monitored during a Priority scan.)
 - Rotate [SELECTOR] or push [▲]/[▼] on the microphone to check the scanning TAG channels, to change the scanning direction, or to resume the scan manually.
 - A beep tones sounds and “16” blinks when a signal is received on Channel 16 during a Priority scan.
- ⑤ To stop the scan, push [CLR] or repeat step ④.

[Example]: Starting a normal scan.

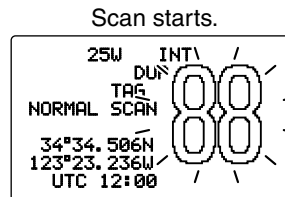
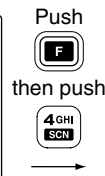
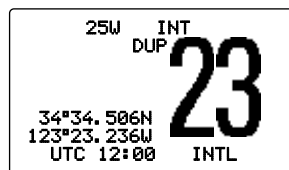

When a signal is received

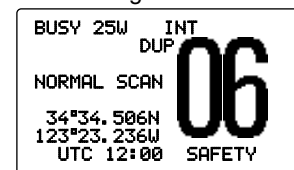

6

DSC OPERATION

■ MMSI code programming

The 9 digit MMSI (Maritime Mobile Service Identity: DSC self ID) code can be programmed at power ON.

/// This code programming can only be performed TWICE.

- ① First, turn OFF the transceiver. Then, while holding down [MENU], push [POWER] to turn ON the transceiver to enter the MMSI code programming mode.
- ② After the DSC menu screen is displayed, release [MENU].
- ③ Enter "MMSI check" in the DSC Set up menu.

```

<DSC Menu> ⇄ <Set up> ⇄ <MMSI Check>
(Push [MENU]) (Rotate [SELECTOR], then push [ENT].)

```

- ④ Edit the specific MMSI code by pushing the keypad keys.
 - Rotate [SELECTOR] to move the cursor backward or forward.

```

--DSC Menu--
MMSI Check
  █
-----
<CLR>Exit / <ENT>OK>

```

- ⑤ After carefully entering the 9 digit code, then push [ENT] to set the code.
 - Returns to the DSC set up menu.
- ⑥ Push [CLR] or rotate [SELECTOR] to select "Exit," then push [ENT] to return to the DSC menu.
 - Push [ENT] again to return to the normal operating mode.

■ DSC address ID

A total of 100 DSC address IDs can be entered, and a name of up to 10 characters assigned to the ID.

◇ Programming Individual ID

- ① Enter "Add: INDU ID" in the DSC Set up menu.

```

<DSC Menu> ⇄ <Set up> ⇄ <Add: INDU ID>
(Push [MENU]) (Rotate [SELECTOR], then push [ENT].)

```

- ② Set the individual ID and ID name by pushing the keypad keys.
 - Edit the 9 digits of the appropriate distress ID directly with the keypad.
 - Rotate [SELECTOR] to move the cursor backward or forward.
 - Push [CE] to clear the ID and name.
 - Push [CLR] to cancel and exit the screen.

```

--DSC Menu--
Add: Individual ID
Input 9 digits
  █
-----
Input name
-----
<CLR>Exit / <ENT>OK>

```

- ③ Push [ENT] to set the ID and return to the DSC set up menu.
- ④ Push [CLR] or rotate [SELECTOR] to select "Exit," then push [ENT] to return to the DSC menu.
 - Push [ENT] again to return to the normal operating mode.

◆ Deleting Individual ID

- Enter "DEL:INDV ID" in the DSC Set up menu.

```

<DSC Menu> ⇨ <Set up> ⇨ <DEL:INDV ID>
(Push [MENU]) (Rotate [SELECTOR], then push [ENT].)
    
```

- When no address ID is programmed, "No ID" is displayed. Push [CLR] to exit.

- Rotate [SELECTOR] to select the desired ID name to delete.

```

--DSC Menu--
Select ID
John
Paul
→George
Michael

<CLR→Exit / ENT→OK>
    
```

- Push [ENT] to delete the selected individual ID and return to the DSC Set up menu.
- Push [CLR] or rotate [SELECTOR] to select "Exit," then push [ENT] to return to the DSC menu.
 - Push [ENT] again to return to the normal operating mode.



◆ Programming Group ID

- Enter "Add:Group ID" in the DSC Set up menu.

```

<DSC Menu> ⇨ <Set up> ⇨ <Add:Group ID>
(Push [MENU]) (Rotate [SELECTOR], then push [ENT].)
    
```

- Set the group ID and ID name by pushing the keypad keys.
 - Edit the 8 digits of the group ID by pushing the keypad keys.
 - Rotate [SELECTOR] to move the cursor backward or forward.
 - Push [CE] to clear the ID and name.
 - Push [CLR] to cancel and exit the screen.

-  The first one digit is fixed for a group ID.
-  The first two digits are '0' for any Coast station ID.

```

--DSC Menu--
Add:Group ID
Input 8 digits
█
Input name
-----

<CLR→Exit / ENT→OK>
    
```

- Push [ENT] to set the ID and return to the DSC Set up menu.
- Push [CLR] or rotate [SELECTOR] to select "Exit," then push [ENT] to return to the DSC menu.
 - Push [ENT] again to return to the normal operating mode.

◆ Deleting Group ID

- Enter "DEL:Group ID" in the DSC Set up menu.

```

<DSC Menu> ⇨ <Set up> ⇨ <DEL:Group ID>
(Push [MENU]) (Rotate [SELECTOR], then push [ENT].)
    
```

- When no address ID is programmed, "No ID" is displayed. Push [CLR] to exit.
- Rotate [SELECTOR] to select the desired ID name to delete.
 - Push [ENT] to delete the selected group ID and return to the DSC Set up menu.
 - Push [CLR] or rotate [SELECTOR] to select "Exit," then push [ENT] to return to the DSC menu.
 - Push [ENT] again to return to the normal operating mode.

■ Position and Time display

When a GPS receiver (NMEA0183 ver. 2.0 or 3.01) is connected, the transceiver displays the current position and time. When no GPS receiver is connected, the transceiver displays the manually entered position and time.

A GPS receiver appropriate for the IC-M604A is not supplied from Icom. A GPS receiver in NMEA0183 ver. 2.0 or 3.01 format is required for position and time indication. Ask your dealer about suitable GPS receivers.

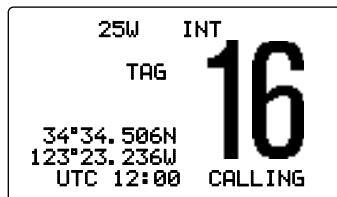

- With a receiver that is compatible with several sentence formats, the order of input precedence is 'RMC,' 'GGA,' 'GNS', 'GLL' and 'VTG.'
- When sentence format 'RMC' is received, the time display includes a date. Thus, the "UTC" or "Local" icon is not displayed.
- "??" may blink instead of position and time displays when the GPS data is invalid, or has not been manually updated for 4 hours.
- A warning alarm sounds when the GPS data has been interrupted for 10 minutes, or has not been manually updated for 4 hours.

■ GPS information display

When a GPS receiver (NMEA0183 ver. 2.0 or 3.01) is connected, the transceiver displays the GPS information after holding down [ENT] for 1 second.

Hold down  for 1 second

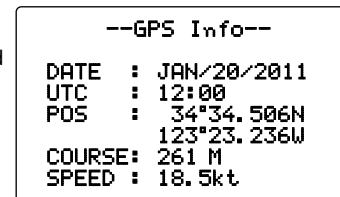

6 DSC OPERATION

■ Distress call

A Distress call should be transmitted if, in the opinion of the Master, the ship or a person is in distress and requires immediate assistance.

NEVER USE THE DISTRESS CALL WHEN YOUR SHIP OR A PERSON IS NOT IN AN EMERGENCY. A DISTRESS CALL CAN BE USED ONLY WHEN IMMEDIATE HELP IS NEEDED.

◇ Simple call

- ① Confirm no Distress call is being received.
- ② While lifting up the key cover, hold down **[DISTRESS]** for 5 seconds to transmit the Distress call.
 - Emergency channel (Channel 70) is automatically selected and the Distress call is transmitted.
 - When no GPS is connected, input your position and UTC time, if possible.
 - While holding down **[DISTRESS]**, the key backlight blinks.

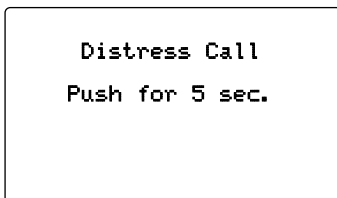

- ③ After transmitting the call, the transceiver waits for an acknowledgment call.
 - The Distress call is automatically transmitted every 3.5 to 4.5 minutes.
 - After 2 seconds, the transceiver is automatically set to Channel 16.

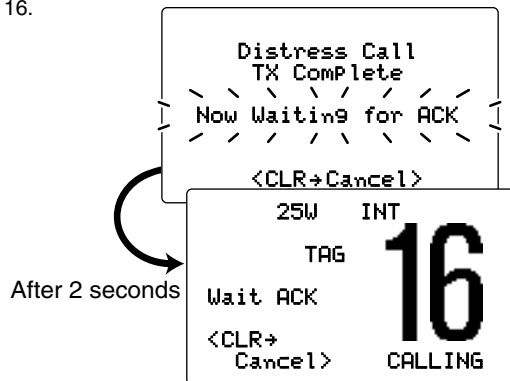

- ④ After receiving the acknowledgment, reply using the microphone.

```

25W INT
TAG
Received 16
DistressACK
<Osaka Bay
<CLR+
BeeP Off> CALLING

```

- ➔ A distress alert contains (default);
 - Kind of distress : Undesignated distress
 - Position data : The latest GPS or manual input position data is held for 23.5 hours, or until the transceiver is turned OFF.
- ➔ The Distress call is repeated every 3.5 to 4.5 minutes, until receiving an 'acknowledgement.' ('Call repeat' mode)
- ➔ Push **[DISTRESS]** to transmit a renewed Distress call, if required.
- ➔ Push **[CLR]** to cancel the 'Call repeat' mode.
- ➔ "???" may blink instead of position and time displays when the GPS data is invalid, or has not been manually updated for 4 hours.

◇ Regular call

The nature of the Distress call should be included in the Distress call.

- ① Enter "Distress Setting" in the DSC menu.

```

<DSC Menu> → <Distress Setting>
(Push [MENU]) (Rotate [SELECTOR], then push [ENT].)

```

- ② Rotate **[SELECTOR]** to select the nature of the distress, then push **[ENT]**.

- 'Undesignated,' 'Explosion,' 'Flooding,' 'Collision,' 'Grounding,' 'Capsizing,' 'Sinking,' 'Adrift (Disable adrift),' 'Abandoning (Abandoning ship),' 'Piracy (Piracy attack)' and 'MOB (Man overboard)' are selectable.
- The nature of the distress is stored for 10 minutes after a selection is made.

```

--DSC Menu--
Select Nature
Undesignated
+Explosion
Flooding
Collision
<CLR→Exit / ENT→OK>

```

- ➔ When a GPS receiver (NMEA0183 ver. 2.0 or 3.01) is connected, steps ③ and ④ (Current position/time programming) are not displayed. Go to step ⑤.

6 DSC OPERATION

◇ Regular call (Continued)

- ③ The position information is displayed. Edit your position (latitude and longitude) data by pushing the keypad keys.
- Push **[6•MNO]** to edit N; North latitude or **[7•PRS]** to edit S; South latitude.
 - Push **[3•DEF]** to edit E; East longitude or **[9•WXY]** to edit W; West longitude.
 - Rotate **[SELECTOR]** to move the cursor backward or forward.
 - Push **[CE]** to clear the position data.
 - Push **[CLR]** to cancel and exit the screen.

```
--DSC Menu--
Input Position
Lat/itide
┌──┴──┐
└──┬──┘ N      Null
Lat/itide
┌──┴──┐
└──┬──┘ W      Null
  <CE→Null Data>
  <CLR→Exit / ENT→OK>
```

- ④ After editing the position data, then push **[ENT]** to set. Edit the current UTC time with the keypad, then push **[ENT]**.
- Edit the digit of the current UTC time by pushing the keypad keys.
 - Rotate **[SELECTOR]** to move the cursor backward or forward.
 - Push **[CE]** to clear the time.
 - Push **[CLR]** to cancel and exit the screen.

```
--DSC Menu--
Input UTC Time
┌──┴──┐
└──┬──┘ Null
  <CE→Null Data>
  <CLR→Exit / ENT→OK>
```

- ⑤ Hold down **[DISTRESS]** for 5 seconds to transmit the Distress call.
- While holding down **[DISTRESS]**, the key backlight blinks.
 - The selected nature of the distress is stored for 10 minutes.
- ⑥ After transmitting the Distress call, the transceiver waits for an acknowledgment call.
- The Distress call is automatically transmitted every 3.5 to 4.5 minutes.
 - After 2 seconds, the transceiver is set to Channel 16 automatically.

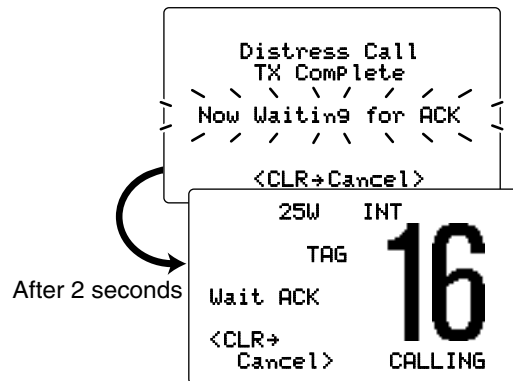

- ⑦ After receiving the acknowledgment, reply using the microphone.

```

      25W   INT
      TAG
Received
DistressACK
<Osaka Bay
<CLR→
Beep Off>   CALLING
16
  
```

- A distress alert contains (default);
 - Kind of distress : Undesignated distress
 - Position data : The latest GPS or manual input position data is held for 23.5 hours, or until the transceiver is turned OFF.
- The Distress call is repeated every 3.5 to 4.5 minutes, until receiving an 'acknowledgement.' ('Call repeat' mode)
- Push **[DISTRESS]** to transmit a renewed Distress call, if required.
- Push **[CLR]** to cancel the 'Call repeat' mode.
- "???" may blink instead of position and time displays when the GPS data is invalid, or has not been manually updated for 4 hours.

■ Transmitting DSC Calls

▨ To ensure the DSC function operated correctly, please make sure you set the squelch correctly. (p. 9)

◇ Transmitting an Individual Call

The Individual Call function allows you to transmit a DSC signal to only a specific ship.

- ① Enter "Individual Call" in the DSC menu.

```

<DSC Menu> ⇄ <Individual Call>
(Push [MENU]) (Rotate [SELECTOR], then push [ENT].)
  
```

- ② Rotate **[SELECTOR]** to select the desired preset individual address or "Manual InPut," then push **[ENT]**.
- The ID code for the Individual Call can be set first. (p. 16)
 - When "Manual InPut" is selected, use the keypad keys to set the 9 digit MMSI ID code for the individual you wish to call.

```

--DSC Menu--
Select Address
Manual InPut
John
→Paul
George
<CLR→Exit / ENT→OK>
  
```

▨ **NOTE:** When a base station is selected in step ②, the voice channel is automatically specified by the base station, then "Individual Call Ready" will be displayed. Therefore, skip step ③ and go directly to step ④.

6 DSC OPERATION

■ Transmitting DSC Calls (Continued)

- ③ Rotate **[SELECTOR]** to select a desired intership channel, or "Manual Input," then push **[ENT]**.
- Inter-ship channels are already preset into the transceiver in the recommended order.

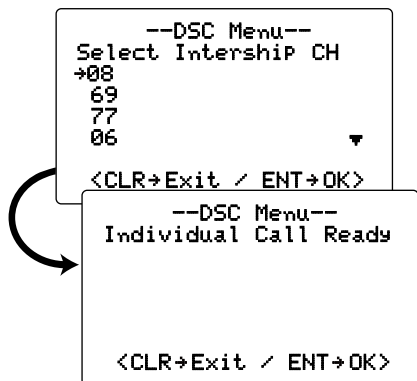

- ④ Push **[ENT]** to transmit the Individual Call.
- If Channel 70 is busy, the transceiver stands by until the channel becomes clear.
- ⑤ Standby on Channel 70 until an acknowledgement is received.

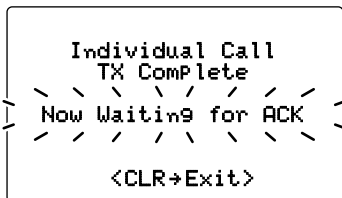

- ⑥ When the acknowledgement 'Able to comply' is received, the channel specified in step ③ is selected and beeps automatically sound. Or, when the acknowledgement 'Unable to comply' is received, beeps sound and the display returns to the operating channel (before you entered the DSC menu).

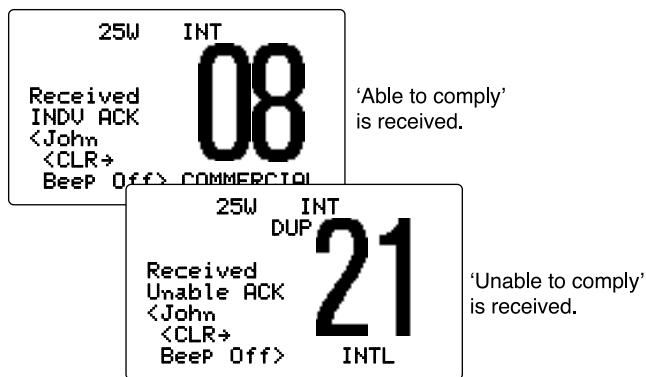

- ⑦ Push **[CLR]** to stop the beep, then hold down **[PTT]** to communicate your message to the responding ship.

✓ *Convenient!*

When the Icom MA-500TR CLASS B AIS TRANSPONDER is connected to your transceiver, an individual DSC Call can be transmitted to a selected AIS target using the transponder, without needing to enter the target's MMSI code. See the MA-500TR instruction manual for more details.

◇ Transmitting an Individual Acknowledgement

When an Individual Call is received, you can transmit an acknowledgement ('Able to comply' or 'Unable to comply') by using the on screen prompts (see page 35 for details). You can also send an acknowledgement through the menu system, as follows.

- ① Enter "Individual ACK" in the DSC menu.

```
<DSC Menu> ⇨ <Individual ACK>
(Push [MENU])      (Rotate [SELECTOR], then push [ENT].)
```

- "Individual ACK" item is displayed after an Individual Call is received.

- ② Rotate [SELECTOR] to select the desired individual address or ID code, then push [ENT].

```
--DSC Menu--
Select Address
John
→Paul
George

<CLR→Exit / ENT→OK>
```

- ③ Rotate [SELECTOR] to select "Able to Comply" or "Unable to Comply," then push [ENT].
- When "Unable to Comply," is selected, 'No reason given' will be transmitted.

```
--DSC Menu--
Select Action
→Able to Comply
Unable to Comply

<CLR→Exit / ENT→OK>
```

↓

```
--DSC Menu--
Individual ACK Ready

<CLR→Exit / ENT→OK>
```

- ④ Push [ENT] to transmit the acknowledgement call to the selected station.
- ⑤ After the Individual acknowledgement call has been transmitted, the specified channel (specified by the calling station) is automatically selected when "Able to Comply" is selected, or returns to the previous screen (before you entered the DSC menu) when "Unable to Comply" is selected in step ③.

6 DSC OPERATION

■ Transmitting DSC Calls (Continued)

◇ Transmitting a Group Call

The Group Call function allows you to transmit a DSC signal to only a specific group.

- ① Enter "Group Call" in the DSC menu.

```
<DSC Menu> ⇄ <Group Call>
(Push [MENU])      (Rotate [SELECTOR], then push [ENT].)
```

- ② Rotate [SELECTOR] to select the desired preset group address or "Manual Input," then push [ENT].
- The ID code for the Group Call can be set first. (p. 17)
 - When "Manual Input" is selected, set the 8 digit ID code for the group you wish to call using keypad keys.

```
--DSC Menu--
Select Address
Manual Input
→Icom
Group A

<CLR→Exit / ENT→OK>
```

- ③ Rotate [SELECTOR] to select a desired intership channel or "Manual Input," then push [ENT].
- Intership channels are already preset into the transceiver in recommended order.
- ▨ The first one digit is specified '0' for a Group ID.
▨ The first two digits are '0' for any Coast station ID.

```
--DSC Menu--
Select Intership CH
→08
69
77
06
▼

<CLR→Exit / ENT→OK>
```

→

```
--DSC Menu--
Group Call Ready

<CLR→Exit / ENT→OK>
```

- ④ Push [ENT] to transmit the Group Call.
- If Channel 70 is busy, the transceiver stands by until the channel becomes clear.
- ⑤ After the Group Call has been transmitted, the following message is displayed.

```
Group Call
TX Complete

<CLR→Exit>
```

- ⑥ Push [CLR] to exit and the transceiver automatically selects the intership channel specified in step ③.
- Even if [CLR] has not been pushed, the transceiver automatically selects the specified intership channel in step ③ after 2 seconds of inactivity.

◇ Transmitting an All Ships Call

Large ships use Channel 70 as their 'listening channel.' When you want to announce a message to all ships within range, use the 'All Ships Call' function.

- ① Enter "All Ships Call" in the DSC menu.

```

<DSC Menu>  ⇐  <All Ships Call>
(Push [MENU])  (Rotate [SELECTOR], then push [ENT].)
    
```

- ② Rotate [SELECTOR] to select a desired category, then push [ENT].

- The selectable category may differ, depending on the programmed setting. Ask your dealer for the selectable categories.

```

--DSC Menu--
Select Category
→Safety
  Urgency

<CLR→Exit / ENT→OK>
    
```

- ③ Rotate [SELECTOR] to select a desired traffic channel, then push [ENT].
 - The selected channel is displayed.

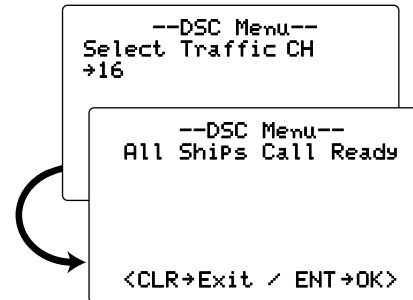

- ④ Push [ENT] to transmit the All Ships Call.
 - Channel 70 is selected and the All Ships Call is transmitted.
- ⑤ After the call has been transmitted, the following message is displayed.

```

All Ships Call
TX Complete

<CLR→Exit>
    
```

- ⑥ Push [CLR] to exit and the transceiver automatically selects Channel 16.
 - Even if [CLR] has not been pushed, the transceiver automatically selects Channel 16 after 2 seconds of inactivity.

6 DSC OPERATION

■ Transmitting DSC Calls (Continued)

◇ Transmitting a Position Request Call

Transmit a Position Request Call when you want to know a specific ship's current position.

- ① Enter "Position Request" in the DSC menu.

```
<DSC Menu> ⇄ <Position Request>
(Push [MENU])      (Rotate [SELECTOR], then push [ENT].)
```

- ② Rotate [SELECTOR] to select the desired preset individual address or "Manual InPut," then push [ENT].

- The ID code can be set first. (p. 16)
- When "Manual InPut" is selected, push the keypad keys to set the 9 digit MMSI number for the individual you wish to call.

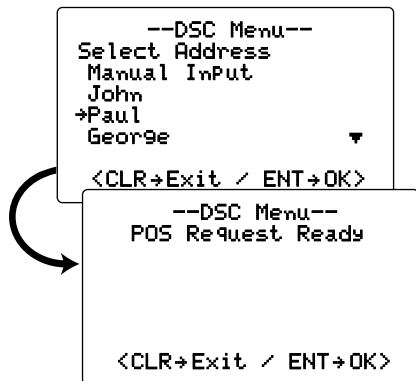

- ③ Push [ENT] to transmit the Position Request Call.

- If Channel 70 is busy, the transceiver stands by until the channel becomes clear.

- ④ After the Position Request Call has been transmitted, the following message is displayed.

```
Position Request
TX Complete
Now Waiting for ACK
<CLR→Exit>
```

- ⑤ Push [CLR] to return to the previous screen before you entered the DSC menu.

- Even if [CLR] has not been pushed, the display automatically returns to the previous screen after 2 seconds of inactivity.

◇ Transmitting a Position Report Call

Transmit a Position Report Call when you want to announce your own position to a specific ship and receive an answer back.

- ① Enter "Position RePort" in the DSC menu.

```
<DSC Menu> ⇄ <Position RePort>
(Push [MENU]) (Rotate [SELECTOR], then push [ENT].)
```

- ② Rotate [SELECTOR] to select the desired preset individual address or "Manual InPut," then push [ENT].
 - The ID code can be set first. (p. 16)
 - When "Manual InPut" is selected, push the keypad keys to set the 9 digit MMSI number for the individual you wish to call.

```
--DSC Menu--
Select Address
Manual InPut
John
→Paul
George
<CLR→Exit / ENT→OK>
```

When a GPS receiver (NMEA0183 ver. 2.0 or 3.01) is connected, next steps ③ and ④ (Current position/time programming) are not displayed. Go to step ⑤.

- ③ The position information is displayed. Edit your position data (latitude and longitude) by pushing the keypad keys. (p. 18)
- ④ After editing the position data, then push [ENT] to set. Then set the current UTC time directly with the keypad, then push [ENT].

```
--DSC Menu--
Position RePort Ready

<CLR→Exit / ENT→OK>
```

- ⑤ Push [ENT] to transmit the Position Report Call.
 - If Channel 70 is busy, the transceiver stands by until the channel becomes clear.
- ⑥ After the Position Report Call has been transmitted, the following message is displayed.

```
Position RePort
TX Complete

<CLR→Exit>
```

- ⑦ Push [CLR] to return to the previous screen before you entered the DSC menu.
 - Even if [CLR] has not been pushed, the display automatically returns to the previous screen after 2 seconds of inactivity.

6 DSC OPERATION

■ Transmitting DSC Calls (Continued)

◇ Transmitting a Polling Request Call

Transmit a Polling Request Call when you want to know if a specific vessel is within communication range.

- ① Enter "Polling Request" in the DSC menu.

```
<DSC Menu>  ⇐  <Polling Request>
(Push [MENU])  (Rotate [SELECTOR], then push [ENT].)
```

- ② Rotate [SELECTOR] to select the desired preset individual address or "Manual InPut," then push [ENT].

- The ID code can be set first. (p. 16)
- When "Manual InPut" is selected, push the keypad keys to set the 9 digit MMSI number for the individual you wish to call.

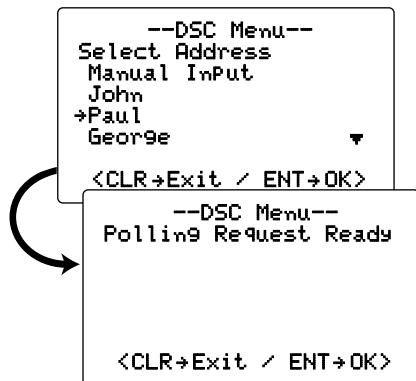

- ③ Push [ENT] to transmit the Polling Request Call.
- ④ After the call has been transmitted, the following message is displayed.

```
Polling Request
TX Complete
-----
Now Waiting for ACK
-----
<CLR→Exit>
```

- ⑤ Push [CLR] to return to the previous screen before entering DSC menu.
 - Even if [CLR] has not been pushed, the display automatically returns to the previous screen after 2 seconds of inactivity.

◇ Transmitting a Position Reply Call

Transmit a Position Reply Call when a Position Request Call is received.

- ① Enter "Position Reply" in the DSC menu.

```

<DSC Menu>  ←  <Position Reply>
(Push [MENU])    (Rotate [SELECTOR], then push [ENT].)
  
```

- ② Rotate [SELECTOR] to select the desired individual address or ID code, then push [ENT].

When a GPS receiver (NMEA0183 ver. 2.0 or 3.01) is connected, next steps ③ and ④ (Current position/time programming) are not displayed. Go to step ⑤.

- ③ The position information is displayed. Edit your position data (latitude and longitude) by pushing the keypad keys. (p. 18)
- ④ After editing the position data, then push [ENT] to set. Edit the current UTC time by pushing the keypad keys, then push [ENT].

```

--DSC Menu--
Position Reply Ready

<CLR>Exit / ENT>OK>
  
```

- ⑤ Push [ENT] to transmit the Position Reply Call to the selected station.
- Your position data is transmitted, when [ENT] is pushed.

◇ Transmitting a Position Report Reply Call

Transmit a Position Report Reply Call when a Position Report Call is received.

- ① Enter "POS Report Reply" in the DSC menu.

```

<DSC Menu>  ←  <POS Report Reply>
(Push [MENU])    (Rotate [SELECTOR], then push [ENT].)
  
```

- ② Rotate [SELECTOR] to select the desired individual address or ID code, then push [ENT].
- ③ Push [ENT] to transmit the Position Report Reply Call to the selected station.

◇ Transmitting a Polling Reply Call

Transmit a Polling Reply Call when a Polling Request Call is received.

- ① Enter "Polling Reply" in the DSC menu.

```

<DSC Menu>  ←  <Polling Reply>
(Push [MENU])    (Rotate [SELECTOR], then push [ENT].)
  
```

- ② Rotate [SELECTOR] to select the desired individual address or ID code, then push [ENT].
- ③ Push [ENT] to transmit the Polling Reply Call to the selected station.

6 DSC OPERATION

■ Transmitting DSC Calls (Continued)

◇ Test call

Testing on the exclusive DSC distress and safety calling channels should be avoided as much as possible by using other methods. When testing on the distress/safety channel is unavoidable, it should be indicated that these are test transmissions.

Normally the test call would require no further communications between the two stations involved.

- ① Enter "Test Call" in the DSC menu.

```
<DSC Menu> ⇄ <Test Call>
(Push [MENU]) (Rotate [SELECTOR], then push [ENT].)
```

- ② Rotate **[SELECTOR]** to select a desired preset Individual address or "Manual InPut," then push **[ENT]**.
 - The ID code for the individual can be set first. (p. 16)
 - When "Manual InPut" is selected, push the keypad keys to set the 9 digit MMSI ID code for the individual you wish to call.

```
--DSC Menu--
Select Address
Manual InPut
→ John
Paul
George
<CLR→Exit / ENT→OK>
```

- ③ After step ②, "Test Call Ready" is displayed.

```
--DSC Menu--
Test Call Ready
<CLR→Exit / ENT→OK>
```

- ④ Push **[ENT]** to transmit the Test call.
 - If Channel 70 is busy, the transceiver stands by until the channel becomes clear.

```
Test Call
```

- ⑤ After the Test call has been transmitted, the display automatically returns to the previous screen (before you entered the DSC menu).

◇ Transmitting a Test Ack call

Transmit a Test Acknowledgement call when a Test call is received.

- Enter "Test ACK" in the DSC menu.
 - "Test ACK" is displayed after receiving a Test call.

```
<DSC Menu> ⇄ <Test ACK>
(Push [MENU]) (Rotate [SELECTOR], then push [ENT].)
```

- Rotate [SELECTOR] to select a desired individual address, then push [ENT].

```
--DSC Menu--
Select Address
→Paul

<CLR→Exit / ENT→OK>
```

- After pushing [ENT], Channel 70 is automatically selected and "Test ACK Ready" is displayed.

```
--DSC Menu--
Test ACK Ready

<CLR→Exit / ENT→OK>
```

- Push [ENT] to transmit the Test Ack call.

Test ACK

- After the Test Ack call has been transmitted, the display automatically returns to the previous screen (before you entered the DSC menu).

■ Receiving DSC Calls

◇ Receiving a Distress call

While monitoring Channel 70 and a distress call is received:

- The emergency alarm sounds.
- “☒” and the LCD backlight blink.
 - Push [CLR] to stop the beep and the backlight blinking.
- “Received Distress” is displayed on the screen, then Channel 16 is automatically selected.
- Continue monitoring Channel 16 as a coast station may require assistance.

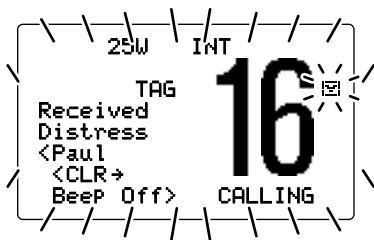

◇ Receiving a Distress Acknowledgement

While monitoring Channel 70 and a Distress acknowledgement to other ship is received:

- The emergency alarm sounds.
- “☒” and the LCD backlight blink.
 - Push [CLR] to stop the beep and the backlight blinking.
- “Received DistressACK” is displayed on the screen, then Channel 16 is automatically selected.

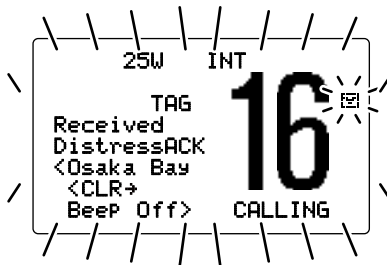

◇ Receiving a Distress Relay call/ Distress Relay Acknowledgement

While monitoring Channel 70 and a Distress Relay call/Distress Relay Acknowledgement is received:

- The emergency alarm sounds.
- “☒” and the LCD backlight blink.
 - Push [CLR] to stop the beep and the backlight blinking.
- “Received DistressRLY”/“DTR RLY ACK” is displayed on the screen, then Channel 16 is automatically selected.

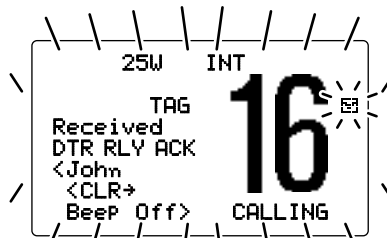
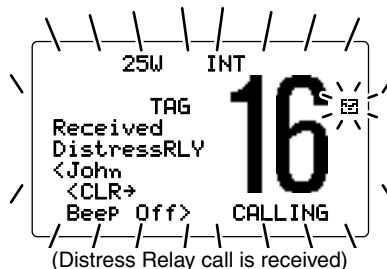

(Distress Relay Acknowledgement is received)

◇ Receiving an Individual Call

While monitoring Channel 70 and an Individual Call is received:

- The emergency alarm or beeps sound, depending on the received category.
- “Received Individual” is displayed on the screen.
- “☒” and the LCD backlight blink.
- Push [CLR] to stop the beeps and the backlight blinking, then push [ENT] to reply to the call and select the channel specified by the calling station for voice communication (depending on your situation see page 25 for individual acknowledgement call procedure for details.); push [CLR] to ignore the Individual Call.



◇ Receiving a Group Call

While monitoring Channel 70 and a Group Call is received:

- The emergency alarm or beeps sound depending on the received category.
- “Received Group” is displayed on the screen.
- “☒” and the LCD backlight blink.
- Push [CLR] to stop the beeps and the backlight blinking, then push [ENT] to monitor the specified channel for an announcement from the calling vessel; push [CLR] to ignore the Group Call.



◇ Receiving an All Ships call

While monitoring Channel 70 and an All Ships call is received:

- The emergency alarm sounds when the category is 'Distress' or 'Urgency'; 2 beeps sound for other categories.
- “Received All Ships” is displayed on the screen.
- “☒” and the LCD backlight blink.
- Push [CLR] to stop the beeps and the backlight blinking, then push [ENT] to monitor channel 16 for an announcement from the calling vessel, push [CLR] to ignore the call.

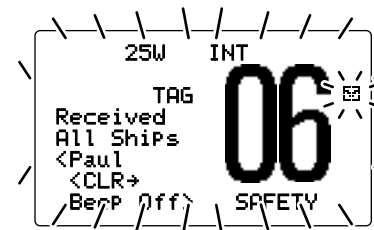

6 DSC OPERATION

■ Receiving DSC Calls (Continued)

◇ Receiving a Geographical Area call

While monitoring Channel 70 and a Geographical Area call (for the area you are in) is received:

- Emergency alarm or beeps sound depending on the received category.
- “Received GeoGraphic” is displayed on the screen.
- “☒” and the LCD backlight blink.

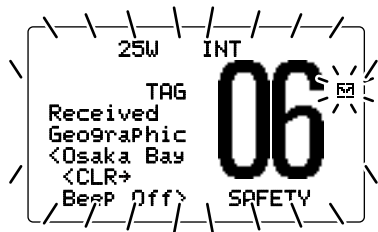

- Push [CLR] to stop the beeps and the backlight blinking, then push [ENT] to change to the channel specified by the calling station for voice communication; push other key to ignore the Geographical Area call.
- Monitor the selected channel for an announcement from the calling station.

▨ When no GPS receiver is connected or if there is a problem with the connected receiver, all Geographical Area calls are received, regardless of your position.

◇ Receiving a Position Request Call

While monitoring Channel 70 and a Position Request Call is received:

- “Received POS Request” is displayed on the screen.
- “☒” and the LCD backlight blink.
- Push [CLR] to stop the beep and the backlight blinking, then push [ENT] to reply to the call; push [CLR] to ignore the call.

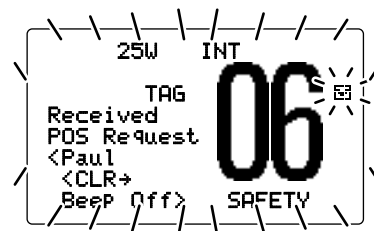

◇ Receiving a Position Report Call

While monitoring Channel 70 and a Position Report Call is received:

- “Received POS Report” is displayed on the screen.
- “☒” and the LCD backlight blink.
- Push [CLR] to stop the beeps and the backlight blinking, then push [ENT] to reply to the call; push [CLR] to ignore the call.
 - After transmitting a reply call, then push [ENT] to display the position information, or push [CLR] to exit the screen.

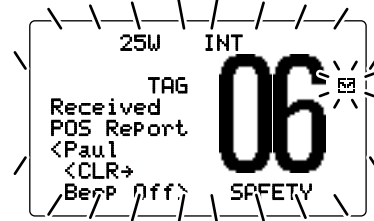

◇ Receiving a Polling Request Call

While monitoring Channel 70 and a Polling Request Call is received:

- “Received POLL REQ” is displayed on the screen.
- “☐” and the LCD backlight blink.
- Push [CLR] to stop the beep and the backlight blinking, then push [ENT] to reply to the call; push [CLR] to ignore the call.

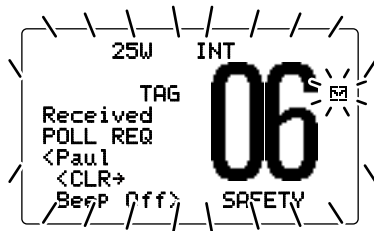

◇ Receiving a Position Reply Call

While monitoring Channel 70 and a Position Reply Call is received:

- “Received POS RePlY” is displayed on the screen.
- “☐” and the LCD backlight blink.
- Push [CLR] to stop the beep and the backlight blinking, then push [ENT] to display the position information; push [CLR] to ignore the reply call.

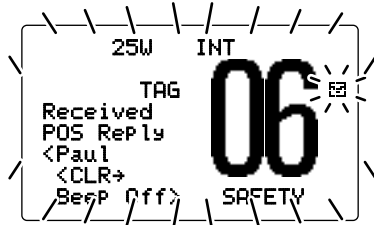

◇ Receiving a Position Report Reply Call

While monitoring Channel 70 and a Position Report Reply Call is received:

- “Received POS RePlY” is displayed on the screen.
- “☐” and the LCD backlight blink.
- Push [CLR] to stop the beep and the backlight blinking, then push [ENT] to display the position information; push [CLR] to ignore the reply call.

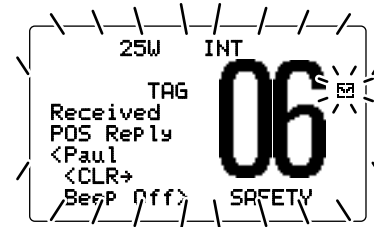

◇ Receiving a Polling Reply Call

While monitoring Channel 70 and a Polling Reply Call is received:

- “Received POLL RePlY” is displayed on the screen.
- “☐” and the LCD backlight blink.
- Push [CLR] to stop the beep and the backlight blinking, then push [CLR] again to exit the screen.

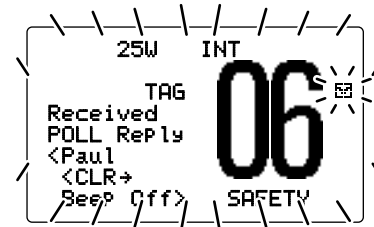

6 DSC OPERATION

■ Receiving DSC Calls (Continued)

◇ Receiving a Test call

When a Test call is received:

- “☒” and the LCD backlight blink.
- The beeps sound for 2 minutes.
 - Push **[CLR]** to stop the beep and the backlight blinking.

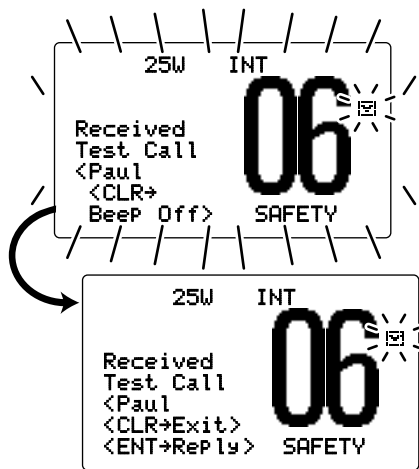

- Push **[ENT]** to reply to the call; push **[CLR]** to ignore the call, and then return to the previous screen (before you received the Test call).

◇ Receiving a Test Acknowledgement call

When a Test Acknowledgement call is received:

- “☒” and the LCD backlight blink.
- The beeps sound for 2 minutes.
 - Push **[CLR]** to stop the beep and the backlight blinking.

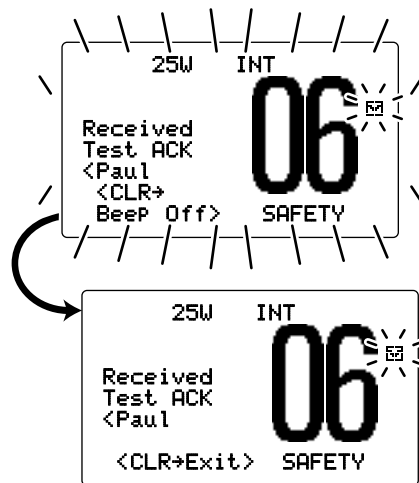

- Push **[CLR]** to return to the previous screen (before you received the Test Acknowledgement call).

◇ **Auto Switch function**

By regulation, after receiving a Distress call, the transceiver basically switches the operating channel to Channel 16. However, when this setting is set to “OFF,” the function enables the transceiver to remain on the operating channel even after receiving a Distress call.

- ① Enter “Auto SW” in the DSC Set up menu.

```

<DSC Menu> ⇄ <Set up> ⇄ <Auto SW>
(Push [MENU])      (Rotate [SELECTOR], then push [ENT].)
```

- ② Rotate [SELECTOR] to turn the Auto switch “ON” or “OFF.”

ON : The transceiver automatically switches the operating channel to Channel 16 after receiving a Distress call.

OFF : The transceiver remains on the operating channel even after receiving a Distress call. (default)

- ③ Push [ENT] to set and exit the setting.
 - Push [CLR] to cancel and exit the setting, if desired.

◇ **Auto Tune timer**

This is the amount of time after receiving a Distress call before the transceiver switches to Channel 16.

- ① Enter “Auto Tune” in the DSC Set up menu.

```

<DSC Menu> ⇄ <Set up> ⇄ <Auto Tune>
(Push [MENU])      (Rotate [SELECTOR], then push [ENT].)
```

- ② Rotate [SELECTOR] to turn the Auto Tune timer “ON” or “OFF.”

ON : After receiving a Distress call, the transceiver remains on the operating channel for 10 seconds, and then automatically switches to Channel 16. (default)

Within 10 seconds, the following action can be taken:

- Push [ENT] to immediately switch to Channel 16.
- Push [CLR] to cancel the Auto tune timer, and the transceiver remains on the operating channel.

OFF : Turns OFF the Auto Tune timer.

- ③ Push [ENT] to set and exit the setting.
 - Push [CLR] to cancel and exit the setting, if desired.

The action of the transceiver may differ, depending on the combination of the Auto Switch function and the Auto Tune timer settings.

• **Combined operation when receiving a DSC Call:**

		Auto Switch	
		OFF	ON
Auto tune	OFF	The transceiver remains on the operating channel. • “⊗” blinks.	The transceiver automatically switches to Channel 16.
	ON	The transceiver remains on the operating channel for 10 seconds, and then automatically switches to Channel 16. Within 10 seconds, the following action can be taken: • When [ENT] is pushed, immediately switches to Channel 16. • When [CLR] is pushed, remains on the operating channel since the Auto Tuner timer is cancelled.	

6 DSC OPERATION

■ Received messages

The transceiver automatically stores up to 20 distress messages and 20 other messages. The messages can be used as a supplement to your logbook.

- “” blinks when there is a message which has not been read.

◇ Distress message

- ① Enter “Distress” in the DSC menu.

```
<DSC Menu> ⇄ <Received Calls> ⇄ <Distress>
(Push [MENU])      (Rotate [SELECTOR], then push [ENT].)
```

- ② Rotate [SELECTOR] to select the desired message, then push [ENT].

- Blinking messages have not been read.
- The messages are stored in “Distress” in the DSC menu if its category or format specifier is ‘Distress.’

```
--DSC Menu--
Select Message
->Distress
->Distress Ack
<CLR→Exit / ENT→OK>
```

- ③ Rotate [SELECTOR] to scroll the selected message.

Rotate



```
--DSC Menu--
Distress
<John
Explosion
LAT: 12°34.567N
LON: 123°45.678W
<CLR→Exit / CE→Del>
```

- ④ Push [CLR] to exit the screen or push [CE] to clear the displayed message and return to the DSC menu.

◇ Other messages

- ① Enter “Other” in the DSC menu.

```
<DSC Menu> ⇄ <Received Calls> ⇄ <Other>
(Push [MENU])      (Rotate [SELECTOR], then push [ENT].)
```

- ② Rotate [SELECTOR] to scroll to the desired message, then push [ENT].

- Blinking messages have not read.

```
--DSC Menu--
Select Message
->Individual Call
->Group Call
Position Replay
All Ships Call
<CLR→Exit / ENT→OK>
```

- ③ Rotate [SELECTOR] to scroll the message.

- The stored message has various information, depending on the type of Distress call.

```
--DSC Menu--
Individual Call
<Paul
Routine
F3E simplex
CH08
<CLR→Exit / CE→Del>
```

- ④ Push [CLR] to exit the screen or push [CE] to clear the displayed message and return to the DSC menu.

■ DSC Set mode

◇ **Add Individual ID/Group ID** (See pages 16, 17)

◇ **Delete Individual ID/Group ID** (See page 17)

◇ **MMSI Code Check**

The programmed 9 digit MMSI (DSC self ID) code can be checked in the DSC Set mode.

① Enter "MMSI Check" in the DSC Set up menu.

```
<DSC Menu> ⇨ <Set up> ⇨ <MMSI Check>
(Push [MENU])      (Rotate [SELECTOR], then push [ENT].)
```

② Check the 9 digit MMSI (DSC self ID) code.

```
--DSC Menu--
MMSI Check
123456789

<CLR>Exit>
```

③ Push [CLR] to return to the DSC Set up menu.

④ Push [CLR] or rotate [SELECTOR] to select "Exit," then push [ENT] to return to the DSC menu.

- Push [ENT] again to return to the normal operating mode.

◇ **Automatic Acknowledgement**

This item sets the automatic acknowledgement function to ON or OFF.

When a position request, position report or polling request call is received, the transceiver automatically transmits a position request reply, position report reply or polling reply call, respectively.

① Enter "Position Auto ACK" in the DSC menu.

```
<DSC Menu> ⇨ <Set up> ⇨ <Position Auto ACK>
(Push [MENU])      (Rotate [SELECTOR], then push [ENT].)
```

② Rotate [SELECTOR] to turn the automatic acknowledgement function ON or OFF.

```
--DSC Menu--
Position Auto ACK
ON
→OFF

<CLR>Exit / ENT→OK>
```

③ Push [ENT] to return to the DSC Set up menu.

④ Push [CLR] or rotate [SELECTOR] to select "Exit," then push [ENT] to return to the DSC menu.

- Push [ENT] again to return to the normal operating mode.

6 DSC OPERATION

■ Received messages (Continued)

◇ Offset Time

This item sets the offset time from the UTC (Universal Time Coordinated) time.

- ① Enter "Offset Time" in the DSC Set up menu.

```
<DSC Menu> ⇄ <Set up> ⇄ <Offset Time>
(Push [MENU]) (Rotate [SELECTOR], then push [ENT].)
```

- ② Set the offset time from the UTC (Universal Time Coordinated) time.
 - Edit the digit of offset time by pushing the keypad keys.
 - Push [0•-/.] to edit "-" or "+", when the cursor is on the first digit.
 - Rotate [SELECTOR] to move the cursor backward or forward.
 - Push [CE] to clear the time data.
 - Push [CLR] to cancel and return to the DSC Set up menu.

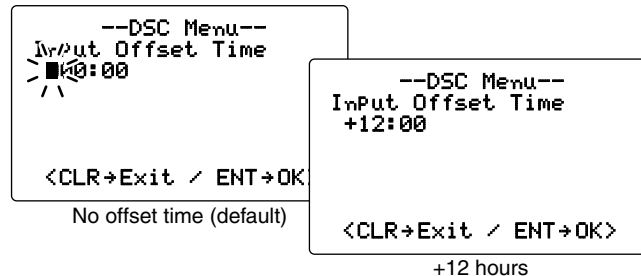

- ③ Push [ENT] to set and return to the DSC Set up menu.
- ④ Push [CLR] or rotate [SELECTOR] to select "Exit," then push [ENT] to return to the DSC menu.
 - Push [ENT] again to return to the normal operating mode.

◇ NMEA Output

Select an NMEA Output function from List Station, All Station or OFF.

When receiving position acknowledgment, the transceiver outputs it to the external equipment via the NMEA connector.

- ① Enter "NMEA Output" in the DSC menu.

```
<DSC Menu> ⇄ <Set up> ⇄ <NMEA Output>
(Push [MENU]) (Rotate [SELECTOR], then push [ENT].)
```

- ② Rotate [SELECTOR] to select the NMEA Output function from List Station, All Station or OFF.
 - List Station : Outputs the position data from the specified vessels listed on the DSC individual ID screen.
 - All Station : Outputs the position data from all vessels.
 - OFF : Outputs no position data to external equipment.



- ③ Push [ENT] to set and return to the DSC Set up menu.
 - Push [CLR] to cancel and exit the mode to DSC set up menu.
- ④ Push [CLR] or rotate [SELECTOR] to select "Exit," then push [ENT] to return to the DSC menu.
 - Push [ENT] again to return to the normal operating mode.

■ Intercom operation

The optional intercom function allows you to talk to the deck from the cabin. The optional COMMANDMICII™ or COMMANDMICIII™ microphone, is required.

Connect the COMMANDMIC™ as described on page 50.

- Up to two COMMANDMIC™s can be simultaneously connected.
- Transmitting is impossible while using the intercom.
- The received signal is muted while using the intercom.

- ① Push [**IC**], then push [**9**•**IC**] to enter the intercom mode.
 - The COMMANDMIC™ power is automatically turned ON, even if the power is OFF.

When the connected COMMANDMIC™ is one, step ② is not displayed. Go to step ③.

- ② Select the desired intercom party, transceiver (RADIO) or COMMANDMIC™ (INTERCOM), then push [**ENT**]*.
 - * Push [**LO/DX**] (**IC** SCR) from the COMMANDMICII™ (HM-157). Push [**LO/DX**•**IC**] SCR) from the COMMANDMICIII™ (HM-162).

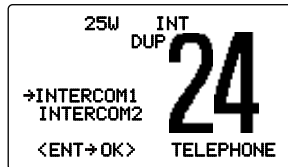

IC-M604A

Select within 5 seconds from entering intercom mode.

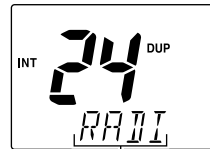

HM-157

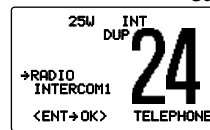

HM-162

NOTE: The COMMANDMIC™, connected to the [COMMAND MIC-1] connector, is recognized as 'INTERCOM1,' and the other side is 'INTERCOM2.'

- ③ Hold down [**9**•**IC**] for more than 1 second to sound the intercom beep while holding.
 - The transceiver and the COMMANDMIC™ second beeps.
- ④ Hold down [**PTT**] and speak into the microphone at a normal voice level.
 - "TALK" or "LISTEN" is displayed on the caller or listener function screen, respectively.
 - * "TALK" or "LSTN" is displayed on the HM-157.
 - "WAIT" is displayed on the IC-M604A or HM-162 if it is idle.
 - To adjust the IC-M604A's speaker output level, rotate [**VOL**].
 - To adjust the HM-157's speaker output level, push [**VOL**•**DIM** PA/RX 4⁰⁰], then push [**▲**] or [**▼**] on the HM-157.
 - To adjust the HM-162's speaker output level, rotate [**SELECTOR**].



IC-M604A (caller)



HM-157 (listener)

The other intercom party is displayed here.

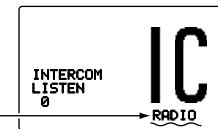

HM-162 (listener)

7 OTHER FUNCTIONS

■ Intercom operation (Continued)

- ⑤ After releasing [PTT] you can hear the response through the speaker.
- ⑥ To return to normal operation, push [CLR] or repeat step ①.

- While in the intercom mode, the transceiver functions (transmit and receive) are interrupted. If the transceiver is in transmit mode, the intercom function is disabled.
- When a DSC Call is received, the intercom function is interrupted with an automatic return to the transceiver mode. The Function screen displays 'Receiving DSC Calls.' (p. 32)
- When a WX alert is received, "WX ALERT" blinks and a beep sounds. The WX alert sounds after the Intercom use is finished.

■ Hailer operation

The IC-M604A has a 2-way hailer function for voice amplification and reception over a loudspeaker, making it unnecessary to leave the bridge to hear a hailing party. Connect an external hailer speaker as described on page 50.

- ① Push [G], then push [7•HAIL] to activate the hailer.



- ② Hold down [PTT] and speak into the microphone at a normal voice level .
 - "TALK" or "LISTEN" respectively is displayed on the caller or listener function display.
 - To adjust the hailer level, rotate [SELECTOR].
- ③ After releasing [PTT] you can hear the response through the speaker.
- ④ To turn OFF the hailer, push [CLR] or repeat step ①.

- While in the hailer mode, the transceiver functions (transmit and receive) are interrupted. If the transceiver is transmitting, the hailer function is disabled.
- When a DSC Call is received, the hailer function is interrupted with an automatic return to the transceiver mode. The Function screen displays 'Receiving DSC Calls.' (p 34)

■ Automatic foghorn

The automatic foghorn function repeatedly sounds a horn until the function is turned OFF. Four patterns are selectable for varying situations.

A hailer speaker is used to sound the foghorn. To use this function, the hailer speaker must be connected to the transceiver. See page 50 for connection details.

TYPE		PATTERN	USAGE
UNDERWAY	One 5-second blasts every 120 seconds.	<p>The diagram shows a single rectangular pulse representing a 5-second blast. A horizontal dimension line below the pulse is labeled $5s \pm 1$. A longer horizontal dimension line below the pulse, representing the interval between blasts, is labeled 120s.</p>	Motor vessel underway and making way.
STOP	Two 5-second blasts (separated by 2 seconds) every 120 seconds.	<p>The diagram shows two rectangular pulses, each representing a 5-second blast. A horizontal dimension line between the two pulses is labeled 2s. A horizontal dimension line below the first pulse is labeled $5s \pm 1$. A longer horizontal dimension line below the two pulses, representing the interval between groups of blasts, is labeled 120s.</p>	Motor vessel underway but stopped (not making way).
SAIL	One 5-second blast followed by two 1-second blasts (each separated by 2 seconds) every 120 seconds.	<p>The diagram shows one rectangular pulse representing a 5-second blast, followed by two smaller rectangular pulses representing 1-second blasts. A horizontal dimension line between the two 1-second pulses is labeled 2s. A horizontal dimension line below the first pulse is labeled $5s \pm 1$. A longer horizontal dimension line below the entire sequence, representing the interval between groups of blasts, is labeled 120s.</p>	Sailing vessel underway, fishing vessel (underway or anchored), vessel not under command, a vessel restricted in her ability to maneuver (underway or at anchor), or a vessel towing or pushing another ahead.
TOW	One 5-second blast followed by three 1-second blasts (each separated by 2-seconds) every 120 seconds.	<p>The diagram shows one rectangular pulse representing a 5-second blast, followed by three smaller rectangular pulses representing 1-second blasts. A horizontal dimension line between the three 1-second pulses is labeled 2s. A horizontal dimension line below the first pulse is labeled $5s \pm 1$. A longer horizontal dimension line below the entire sequence, representing the interval between groups of blasts, is labeled 120s.</p>	Vessel under tow (manned).

/// The audio frequency of the foghorn is selectable. See page 48 for details.

7 OTHER FUNCTIONS

■ Automatic foghorn (Continued)

- ① Push **[F]**, then push **[8•FOG]** to activate the foghorn. .

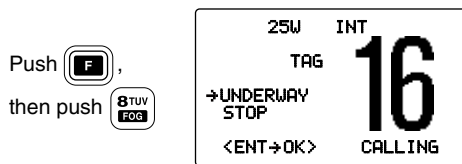

- ② Rotate **[SELECTOR]** to select the desired foghorn pattern, then push **[ENT]**.
- 'UNDERWAY', 'STOP', 'SAIL', 'TOW' are selectable. (p. 45)
 - Even if **[ENT]** has not been pushed, the display automatically changes to the next step after about 5 seconds of inactivity.
- ③ Rotate **[SELECTOR]** to adjust the foghorn level, then push **[ENT]**.
- The foghorn level is adjustable in 31 steps.
 - Even if **[ENT]** has not been pushed, the display automatically changes to the next step after about 5 seconds of inactivity.

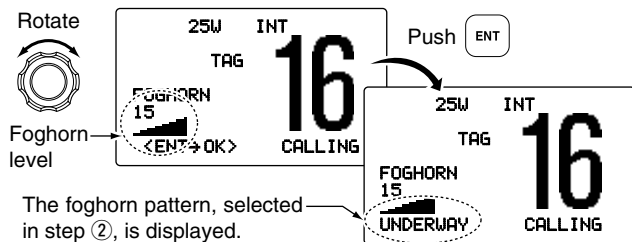

- ④ To return to normal operation, repeat step ①.

When a DSC Call is received, the automatic foghorn function is interrupted with an automatic return to the transceiver mode. The function LCD displays 'Receiving DSC Calls.' (p. 34)

■ RX speaker function

The IC-M604A has an RX speaker function. When this function is turned ON, the received audio can be heard on the deck or tower through a hailer speaker.

Connect a hailer speaker as described on page 50.

- ① Push **[F]**, then hold down **[7•HAIL]** for 1 second to enter the RX Speaker mode.
- "RX" is displayed.

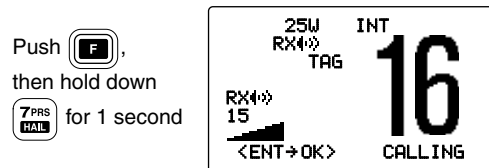

- ② Rotate **[SELECTOR]** to adjust the audio output level, then push **[ENT]**.
- ③ To return to normal operating mode, repeat step ①.

While in the RX speaker mode, rotate **[SELECTOR]** while holding down **[7•HAIL]** after pushing **[F]**, to adjust the audio output level. After adjusting, then push **[ENT]**.

- Rotate **[SELECTOR]** within 1 second after pushing **[7•HAIL]**, or the transceiver returns to the normal operating mode.

■ Set mode programming

The Set mode is used to change the settings of the transceiver's functions: Scan type, Scan resume timer, Weather alert, Beep tone, Internal speaker, LCD contrast, Attenuation level, Automatic foghorn frequency, Radio power*¹, Scrambler type*², Scrambler code*², Favorite channel and Remote ID.

*¹Displayed only when an optional COMMANDMIC™ is connected.

*²Displayed only when an optional scrambler unit is installed.

/// Selectable functions may differ, depending on dealer setting.

- ① Turn OFF the transceiver, then while holding down [16•9], push [POWER] to enter the Set mode.
- ② After the screen is displayed, release [16•9].
- ③ Rotate [SELECTOR] to select the desired item, then push [ENT].
- ④ Rotate [SELECTOR] to select the desired setting of the item, then push [ENT] to set.
- ⑤ Push [CLR], or rotate [SELECTOR] to select "Exit" then push [ENT] to exit the Set mode and return to the normal operating mode.

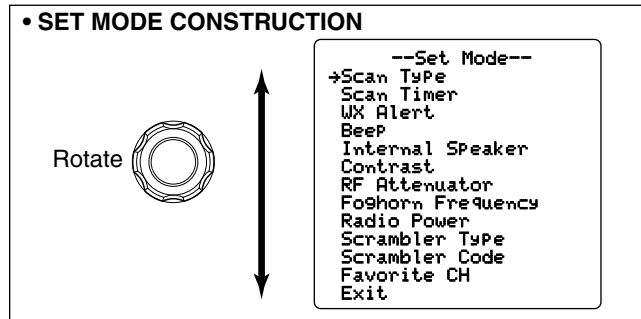

■ Set mode items

◇ Scan type

The transceiver has 2 scan types: normal scan and priority scan. Normal scan searches all TAG channels in the selected channel group. Priority scan sequentially searches all TAG channels while monitoring Channel 16.

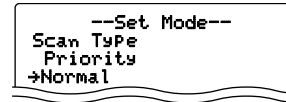

(Default: Normal)

◇ Scan resume timer

The scan resume timer can be selected as a pause (OFF) or timer scan (ON). When OFF is selected, the scan pauses until the signal disappears. When ON is selected, the scan pauses 5 seconds and then resumes, even if a signal has been received on any channel other than Channel 16.



(Default: OFF)

8 SET MODE

◇ Weather Alert

A NOAA broadcast station transmits a weather alert tone before important weather information. When “ON” is selected, the previously selected (used) weather channel is checked any time during standby, or while scanning. When “ON with WX SCAN” is selected, the weather channels are sequentially checked during standby, or while scanning. The “WX ALERT” indicator blinks until the transceiver is operated after the transceiver detects the alert.

- “WX ALERT” is displayed instead of “WX” when the function is turned ON.

```
--Set Mode--  
WX Alert  
ON  
ON with WX SCAN  
→OFF
```

(Default: OFF)

◇ Beep tone

You can select silent operation by turning beep tones OFF, or you can have confirmation beeps sound at the push of a key by turning beep tones ON.

```
--Set Mode--  
Beep  
→ON  
OFF
```

(Default: ON)

◇ Internal speaker

When an external speaker is connected, and the transceiver’s internal speaker is not required, the internal speaker and the speaker in the microphone can be deactivated.

```
--Set Mode--  
Internal Speaker  
→ON  
OFF
```

(Default: ON)

◇ LCD contrast

This item adjusts the contrast of the LCD in 8 steps.

```
--Set Mode--  
Contrast  
→5  
4  
3  
2  
▲  
▼  
<CLR→Exit / ENT→OK>
```

(Default: 5)

◇ Attenuation level

This item sets the receive attenuation level for the Attenuator function from 3 levels.

```
--Set Mode--  
RF Attenuator  
Max  
Mid  
→Min
```

(Default: Min)

◇ Automatic foghorn frequency

The audio frequency of the automatic foghorn can be adjusted to suit your preference. While this item is selected, holding down [PTT] sounds the foghorn— experiment with the selectable frequencies until you find one you like.

- The selectable frequency range is 200 Hz to 850 Hz, in 50 Hz steps.

```
--Set Mode--  
Foghorn Frequency  
→400  
350  
300  
250  
▲  
▼  
<CLR→Exit / ENT→OK>
```

(Default: 400)

◇ **Radio power**

(Displayed when a COMMANDMIC™ is connected)

This item sets the Radio power function to ON or OFF.

ON : The transceiver's power is controlled by the optional command microphone. When the command microphone is turned OFF, the transceiver is automatically turned OFF.

OFF : The transceiver's power is not controlled by the optional command microphone. Even if the command microphone is turned OFF, the transceiver will continue to work.

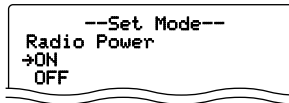

(Default: ON)

◇ **Scrambler type**

(Appears when a scrambler unit is installed)

When an optional scrambler unit* is installed, the scrambler type can be selected in the Set mode, depending on dealer setting.



(Default: UT-112)

* The UT-98 is a discontinued model, and the current model is the UT-112.

◇ **Scrambler code** (Displayed when a scrambler unit is installed)

The scrambler code can be set depending on dealer setting.

- 32 codes (1 to 32) can be selected for UT-112. (Default: 1)
- 128 codes (0 to 127) can be selected for UT-98*. (Default: 0)

When UT-112 is installed

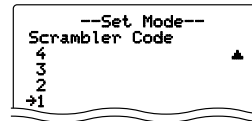

When UT-98 is installed



◇ **Favorite channel**

Sets the Favorite channel function ON or OFF.

The channel is programmed by the TAG channel setting (p. 15).

ON : Pushing [▲]/[▼] on the microphone sequentially selects the favorite channels in the selected channel group.

OFF : Pushing [▲]/[▼] on the microphone sequentially selects all channels in the selected channel group.



(Default: ON)

◇ **Remote ID**

Set a Remote ID number between 01 and 69.

The ID is included in the sentence of the format for the Icom original NMEA.

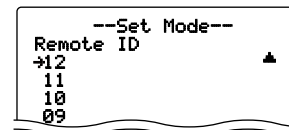

(Default: 12)

■ Connections

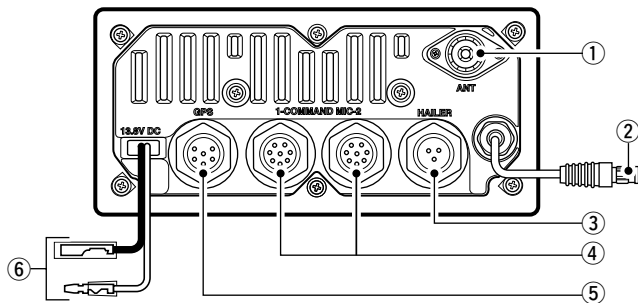

❶ ANTENNA CONNECTOR

Connects a marine VHF antenna with a PL-259 connector to the transceiver.

⚠ **CAUTION:** Transmitting without an antenna will damage the transceiver.

❷ MICROPHONE CONNECTOR

Connect the supplied microphone only.

⚠ **CAUTION: NEVER** connect other microphones here, such as the optional HM-157/HM-162, for they may cause damage to the transceiver.

❸ HAILER/FOGHORN CONNECTOR

Connects a hailer speaker (30 W nominal at 13.8 V/ 4 Ω).



❹ EXTERNAL MICROPHONE CONNECTORS

[COMMAND MIC-1]/[COMMAND MIC-2]

Connects the optional COMMANDMIC™ (HM-157/HM-162.)

⚠ **CAUTION: NEVER** connect other microphone here, such as the HM-134, may cause damage to the transceiver.

❺ GPS RECEIVER/EXTERNAL SPEAKER CONNECTOR

➔ Connects a GPS receiver for position and time display.

- An NMEA0183 ver. 2.0 or 3.01 (sentence format RMC, GGA, GNS, GLL) compatible GPS receiver is required. Ask your dealer about suitable GPS receivers.

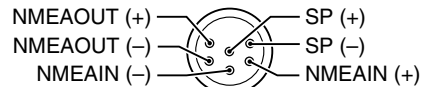

Transceiver's rear panel view

➔ Connects to a PC or navigation equipment (NMEA0183 ver. 3.01 sentence DSC, DSE format compatible) for plotting received position data from other ships.

➔ Connects to an external speaker.

⚠ **NOTE:** Attach the supplied connector covers to ❷, ❸, ❹ or ❺ when they are not in use.

◇ Connect to the MA-500TR

Connect the transceiver to the MA-500TR CLASS B AIS TRANSPONDER using the OPC-2014* NMEA CONNECTOR CABLE. After connecting, an Individual DSC Call can be made to the AIS target using the transponder without entering the target's MMSI code.

* OPC-2014 is supplied with the MA-500TR

• NMEA PIN ASSIGNMENT

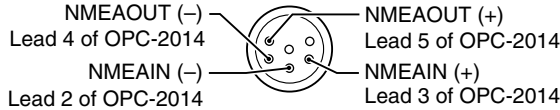

Transceiver's rear panel view

6 DC POWER CONNECTOR

Connect the supplied DC power cable from this connector to an external 13.8 V DC power source.

CAUTION: After connecting the DC power cable, wrap the connectors with a rubber vulcanizing tape, to prevent water seeping into the transceiver.

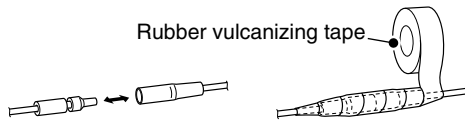

■ Fuse replacement

A fuse is installed in the supplied DC power cable. If the fuse blows, track down the source of the problem, have it repaired, and replace the damaged fuse with a new rated one.

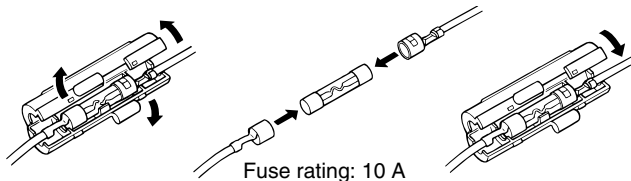

■ Supplied accessories

The following accessories are supplied.

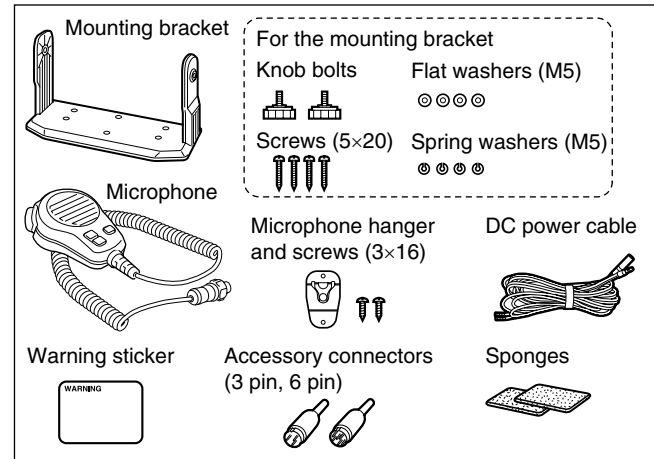

■ Antenna

A key element in the performance of any communication system is the antenna. Ask your dealer about antennas and the best place to mount them.

■ Mounting the transceiver

◇ Using the supplied mounting bracket

The universal mounting bracket supplied with your transceiver allows overhead or upright mounting.

- Mount the transceiver securely with the 4 supplied screws (5 × 20 mm) to a surface which is more than 10 mm (0.4 in) thick and can support more than 5 kg (11 lb).
- Mount the transceiver so that the face of the transceiver is at 90° to your line of sight when operating it.

▨ **KEEP** the transceiver and microphone at least 1 m (3.3 ft) away from the vessel's magnetic navigation compass.

▨ **NOTE:**

- Check the installation angle; the function display may not be easy-to-read at some angles.
- If the transceiver mounting place has strong vibration, use the supplied sponges between the transceiver and mounting bracket to reduce the vibration.

• OVERHEAD MOUNTING

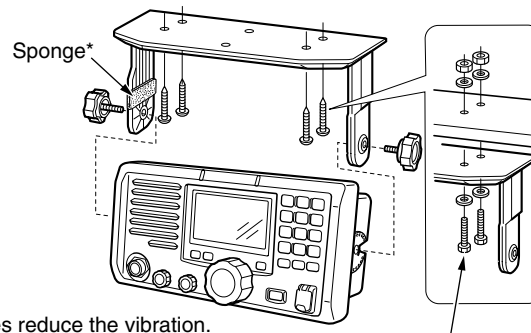

*Sponges reduce the vibration.
See NOTE to the left.

These bolts are shown as only mounting example.
Not supplied with accessories.

• UPRIGHT MOUNTING

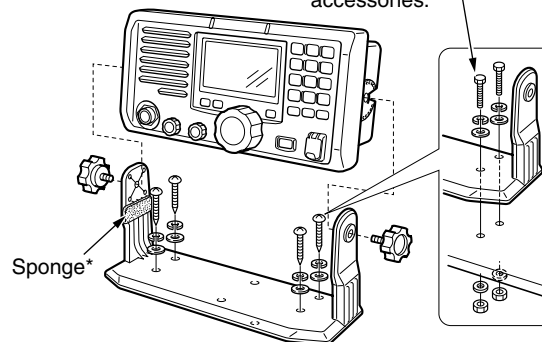

■ MB-75 installation

An optional MB-75 FLUSH MOUNT KIT is available for mounting the transceiver to a flat surface such as an instrument panel.

KEEP the transceiver and microphone at least 1 m (3.3 ft) away from the vessel's magnetic navigation compass.

- ① Using the attached template, carefully cut a hole into the instrument panel (or wherever you plan to mount the transceiver).
- ② Slide the transceiver into the hole as shown below.

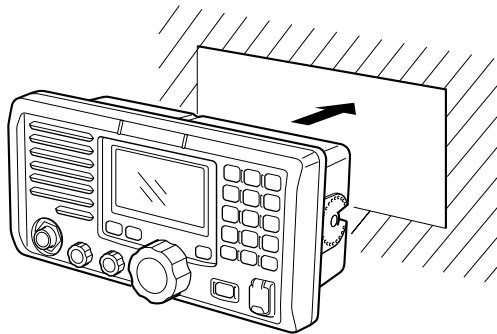

- ③ Attach the 2 supplied bolts (M5 × 8 mm) on either side of the IC-M604A.

- ④ Attach the clamps on either side of the IC-M604A.
 - Make sure that the clamps align parallel to the IC-M604A's body.

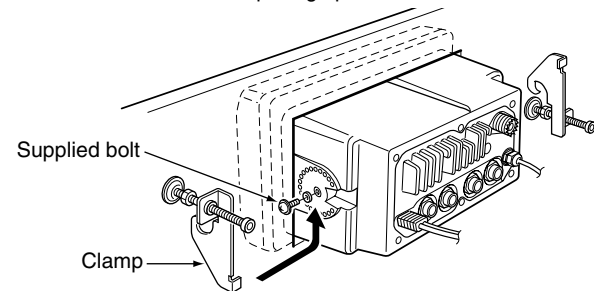

- ⑤ Tighten the end bolts on the clamps (rotate clockwise) so that the clamps press firmly against the inside of the instrument control panel. (Torque: 0.6 N.m)
- ⑥ Tighten the locking nuts (rotate counterclockwise) so that the IC-M604A is securely mounted into position.

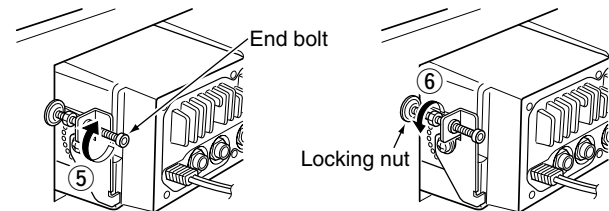

- ⑦ Connect the antenna and power cable.

■ UT-112/UT-98* installation

⚠ WARNING! DISCONNECT the DC power cable from the transceiver before performing any work on the transceiver. Otherwise, there is danger of electric shock and/or equipment damage.

Follow the case opening procedure shown here when you want to install an optional unit (UT-112 or UT-98*).

- ① Remove the 12 screws and open the transceiver.

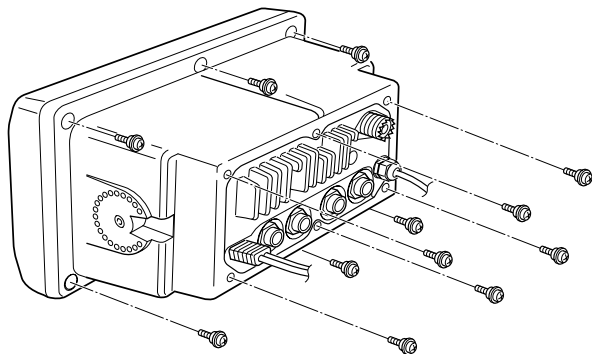

Torque (0.7 N.m)

- ② Turn the transceiver upside down, then disconnect the flat cables and Rear mic control (6-pin) from LOGIC board, and Front mic control (2-pin) and Volume control (3-pin) from AF board.

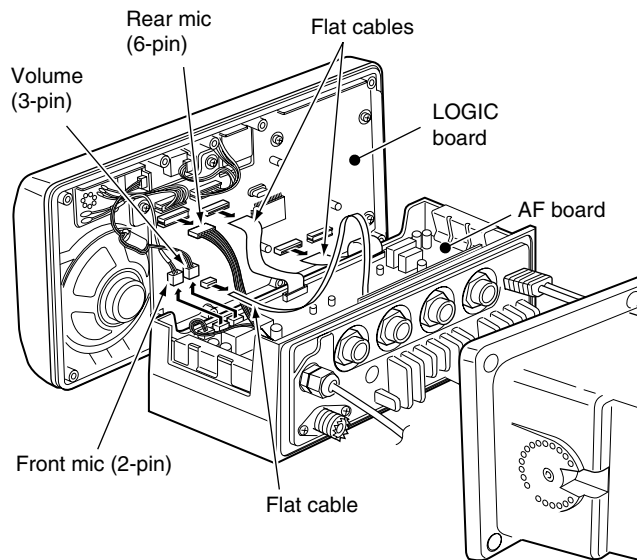

* The UT-98 is the discontinued model, and the current model is the UT-112.

- ③ Install an optional unit to J3 on the AF board as shown below.

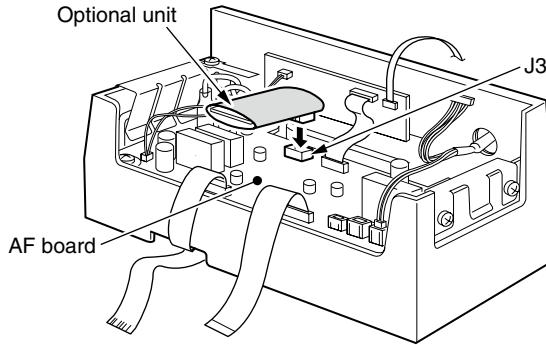

- ④ Reconnect the cables, and reassemble the unit to its original configuration.

CAUTION:

- When re-assembling the case and tightening the screws, you must keep the specified torque (0.7 N.m). Otherwise the transceiver may be damaged (torque too high) or lose waterproof efficiency (torque too low).
- When uninstalling the optional unit, remove it vertically. Wiggling the unit from side to side may damage the connector.

■ HM-157/HM-162 installation

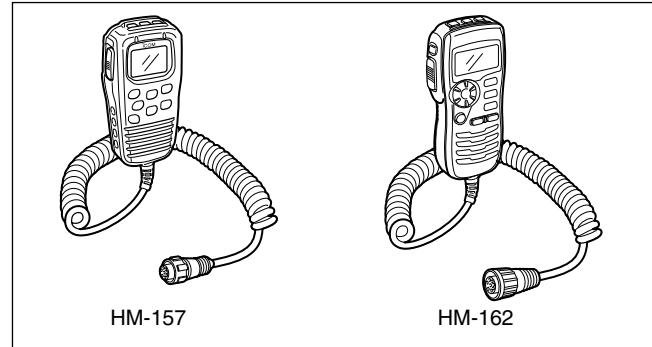

The optional HM-157 can be connected to the transceiver directly, as well as using the supplied connection cable for longer distance remote operation. The connector of the connection cable can be installed into a cabinet, wall, and so on, as a built-in plug.

- The optional HM-162 should be installed to the transceiver using the supplied connection cable.

For longer distance remote operation, the optional extension cable, OPC-999/OPC-1541* (6 m; 20 ft/connecting between transceiver and the connection cable), is available, and up to two OPC-999/OPC-1541* can be added.

*OPC-999 : For the HM-157
 OPC-1541 : For the HM-162

Do not connect the HM-157 to the OPC-1541, and the HM-162 to the OPC-999/OPC-1000.

9 CONNECTIONS AND MAINTENANCE

■ HM-157/HM162 installation (Continued)

- ① Insert the supplied cable (or HM-157 without the cable) into the [COMMAND MIC-1] or [COMMAND MIC-2] connector and tighten the cable nut as shown below.
 - Up to two COMMANDMIC™s can be connected simultaneously.
 - The HM-157 and HM-162 can be connected at the same time.

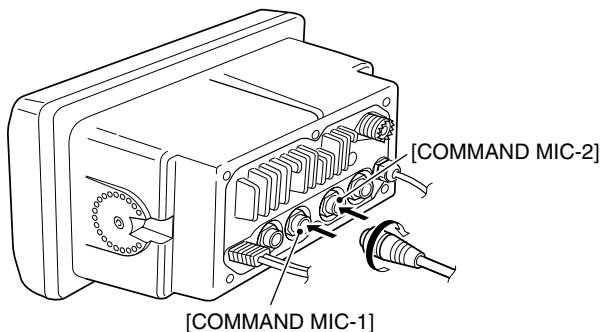

- ② To use the supplied cable as a wall socket, perform the following steps.
- ③ Using the mounting base as a template, carefully mark the holes where the cable and three screws will be fastened.
- ④ Drill holes at these marks.

- ⑤ Install the mounting base using the supplied screws as shown below.

• HM-157

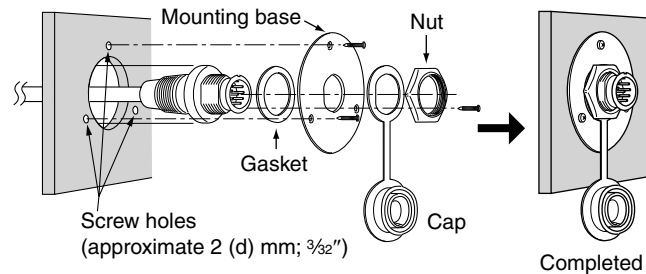

• HM-162

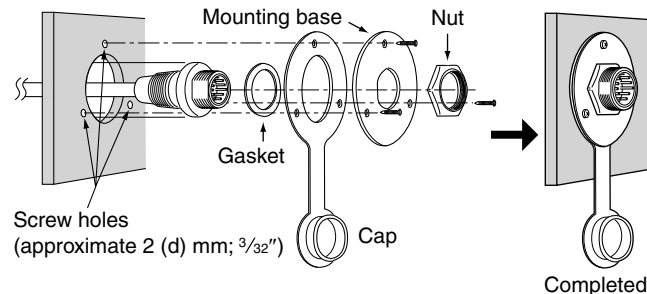

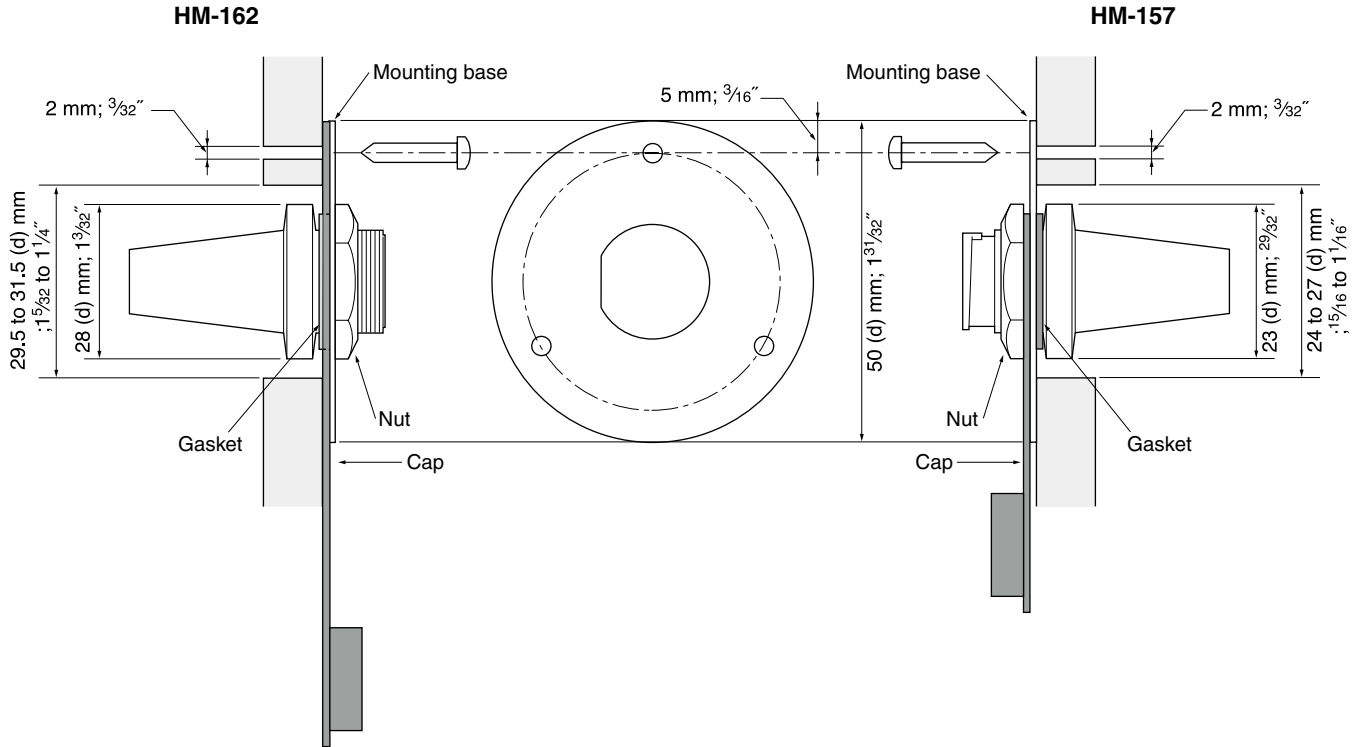

10 TROUBLESHOOTING

PROBLEM	POSSIBLE CAUSE	SOLUTION	REF.
The transceiver does not turn ON.	<ul style="list-style-type: none"> • Bad connection to the power supply. 	<ul style="list-style-type: none"> • Check the connection between the battery- and the transceiver. 	pp. 50, 51
No sound comes from the speaker.	<ul style="list-style-type: none"> • Squelch level is too high. • Volume level is too low. • Speaker has been exposed to water. • Internal speaker is turned OFF. 	<ul style="list-style-type: none"> • Set [SQL] to the threshold point. • Adjust [VOL] to a suitable level. • Clear water from the speaker. • Turn the internal speaker ON in the Set mode. 	p. 9 p. 9 p. 11 p. 48
Sensitivity is low.	<ul style="list-style-type: none"> • The attenuator is activated. 	<ul style="list-style-type: none"> • Push [6•[LO/PTX] after pushing [E] to turn the function OFF. 	p. 9
Transmitting is impossible, or high power cannot be selected.	<ul style="list-style-type: none"> • Some channels are programmed for only low power or receive by regulation. • The output power is set to low. 	<ul style="list-style-type: none"> • Change channels. • Push [H/L] to select high power. 	pp. 7, 8, 61 p. 9
Scan does not start.	<ul style="list-style-type: none"> • TAG channel is not programmed. 	<ul style="list-style-type: none"> • Set the desired channels as TAG channels. 	p. 15
No beep sounds.	<ul style="list-style-type: none"> • Beep tones are turned OFF. • The squelch is open. 	<ul style="list-style-type: none"> • Turn the beep tone ON in the Set mode. • Set [SQL] to the threshold point. 	p. 48 p. 9
Receive signal cannot be understood.	<ul style="list-style-type: none"> • Optional voice scrambler is turned OFF. • Scramble code is not set correctly. 	<ul style="list-style-type: none"> • Turn the optional voice scrambler ON. • Reset the scramble code. 	pp. 12, 49
Distress call cannot be transmitted.	<ul style="list-style-type: none"> • MMSI (DSC self ID) code is not programmed. 	<ul style="list-style-type: none"> • Program the MMSI (DSC self ID) code. 	p. 16

■ Specifications

◇ General

- Frequency coverage: TX 156.025–157.425 MHz
RX 156.050–163.275 MHz
- Mode: FM (16K0G3E), DSC (16K0G2B)
- Current drain (at 13.8 V): TX high (25 W) 5.5 A
Maximum audio 1.5 A
- Power supply requirement: 13.8 V DC \pm 15%
(negative ground)
- Frequency stability: \pm 5 ppm
- Operating temp. range: -20°C to $+60^{\circ}\text{C}$; -4°F to $+140^{\circ}\text{F}$
- Antenna impedance: 50 Ω nominal
- Input impedance (MIC): 2 k Ω
- Output impedance (audio): 4 Ω
- Dimensions: 220(W) \times 110(H) \times 109.4(D) mm
(Projections not included) 8.7(W) \times 4.3(H) \times 4.3(D) in
- Weight: Approximate 1400 g; 3.09 lb

◇ Transmitter

- RF output power: 25 W and 1 W
- Modulation system: Variable reactance frequency modulation
- Maximum frequency deviation: \pm 5.0 kHz
- Spurious emissions: Less than -70 dBc
- Adjacent channel power: More than 70 dB
- Audio harmonic distortion: Less than 10%
(at 1 kHz, 60% deviation)
- Residual modulation: More than 40 dB
- Audio frequency response: $+1$ to -3 dB of 6 dB/octave range from 300 Hz to 3000 Hz

◇ Receiver

- Receive system: Double conversion superheterodyne
- Sensitivity (12 dB SINAD): -120 dBm (typical)
 -120 dBm (typical) (CH 70 receiver)
- Squelch sensitivity: Less than -117 dBm
- Spurious response: More than 80 dB
- Intermodulation: More than 80 dB
- Adjacent channel selectivity: More than 80 dB
- Hum and noise: More than 40 dB
- Audio output power: 5.0 W (typical) at 10% distortion with a 4 Ω load

All stated specifications are subject to change without notice or obligation.

11 SPECIFICATIONS AND OPTIONS

◆ Dimensions

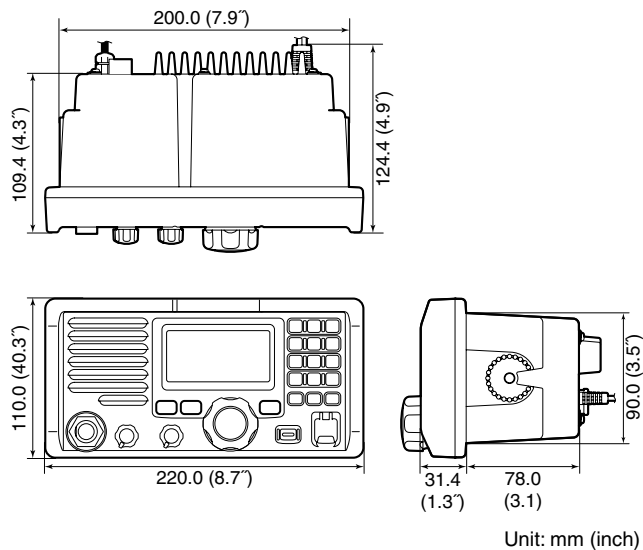

■ Options

- **MB-75** FLUSH MOUNT KIT

For mounting the transceiver to a panel.

- **HM-157** COMMANDMICII™

External microphone-type controller. Provides optional inter-com operation. 6 m (20 feet) microphone cable and mounting base included. Black and white colors are available.

Do not connect the HM-157 to the OPC-1541.

- **HM-162** COMMANDMICIII™

External microphone-type controller. Provides optional inter-com operation. 6 m (20 feet) microphone cable and mounting base included. Black and white colors are available.

Do not connect the HM-162 to the OPC-999/OPC-1000.

- **HM-126RB/RG** HAND MICROPHONE

Equipped with [▲]/[▼] (channel up/down,) [HI/LO] and [PTT] keys, a speaker and microphone.

- **OPC-999** MICROPHONE EXTENSION CABLE

6 m (20 feet) microphone extension cable for optional HM-157 COMMANDMICII™. Up to 2 OPC-999 can be connected. (18 m; 60 feet maximum)

- **OPC-1541** MICROPHONE EXTENSION CABLE

6 m (20 feet) microphone extension cable for optional HM-162 COMMANDMICIII™. Up to 2 OPC-1541 can be connected. (18 m; 60 feet maximum)

- **UT-112** VOICE SCRAMBLER UNIT

Ensures private communications. 32 codes are available. Not available in some countries.

- **OPC-1000** MICROPHONE EXTENSION CABLE

6 m (20 feet) microphone extension cable for the supplied microphone.

Count on us!

A-6914H-1US-①

Printed in Japan

© 2011–2016 Icom Inc.

Printed on recycled paper with soy ink.

Icom Inc.

1-1-32 Kamiminami, Hirano-ku, Osaka 547-0003, Japan