

ICOM

INSTRUCTION MANUAL

VHF MARINE TRANSCEIVER
IC-M58



Icom Inc.

IN CASE OF EMERGENCY

If your vessel requires assistance, contact other vessels and the Coast Guard by sending a distress call on channel 16.

◇ USING CHANNEL 16

DISTRESS CALL PROCEDURE

1. "MAYDAY MAYDAY MAYDAY"
2. "THIS IS -----" (name of vessel)
3. "LOCATED AT-----" (your position)
4. Give the reason for the distress call.
5. Explain what assistance you need.
6. Give additional information:
 - Vessel type
 - Vessel length
 - Vessel color

Or, transmit your distress call using digital selective calling on channel 70 (the optional UX-114 DSC UNIT must be installed).

◇ USING DIGITAL SELECTIVE CALLING (ch 70) (UX-114 required)

DISTRESS CALL PROCEDURE

1. Push and hold [16•EMER] for 5 secs until "DST" appears on the display.
2. After channel 16 is automatically selected, transmit the appropriate information as at left.
3. When you cannot make contact using a DSC distress call, use the "all ships call" function:

Push and hold [9•ALL] (or [C•ALL]) for 5 secs.
 - After a channel is automatically selected, transmit the appropriate information as in step 2.

TABLE OF CONTENTS

IN CASE OF EMERGENCY.....i	5 DIGITAL SELECTIVE	9 CONNECTIONS AND
TABLE OF CONTENTS ii	CALLING.....14–18	MAINTENANCE.....24–27
IMPORTANT iii	■ General.....14	■ Unpacking24
VERSION NOTES..... iii	■ Distress call15	■ Additional requirements24
CAUTIONS iii	■ All ships call (TX).....16	■ Connections.....25
1 OPERATING RULES.....1	■ All ships call (RX).....17	■ Mounting the transceiver.....26
2 PANEL DESCRIPTION..... 2–5	■ Sensor distress call (TX).....18	■ Antenna26
■ Front panel2	■ Individual call (RX).....18	■ Fuse replacement27
■ Function display4	■ Distress call (RX).....18	■ Backup battery27
3 BASIC OPERATION 6–9	■ Distress relay call18	■ Cleaning.....27
■ Power ON.....6	6 MEMORY AND CALL CHANNEL	10 TROUBLESHOOTING28
■ Channel selection6	PROGRAMMING19	11 VHF MARINE CHANNEL LIST...29
■ Receiving8	■ Memory channels19	12 SPECIFICATIONS30
■ Transmitting8	■ Call channel.....19	13 OPTIONS31
4 SCANS.....10–13	7 OTHER FUNCTIONS.....20	
■ General10	■ Voice scrambler.....20	
■ Weather alert12	■ Display backlighting20	
■ Dualwatch/tri-watch.....13	■ Power saver.....20	
	8 SET MODE21–23	
	■ Entering SET mode.....21	

IMPORTANT

READ ALL INSTRUCTIONS carefully and completely before using the transceiver.

SAVE THIS INSTRUCTION MANUAL – This instruction manual contains important safety and operating instructions for the IC-M58.

YOU MUST HAVE a DSC vessel ID in order to operate the optional DSC functions of the transceiver. See your Dealer for details.

VERSION NOTES

This manual describes operating procedures for both the U.S.A. and U.K. versions of the IC-M58. Note that while basic operation is identical for both of these versions, there are some minor differences (see table at right). Keep these differences in mind when following the instructions in this manual as most of the examples make use of the U.S.A. switch nomenclature.

CAUTIONS

NEVER connect the transceiver to more than a 16 V DC power source or an AC outlet. This will ruin the transceiver.

AVOID using or placing the transceiver in direct sunlight or in areas with temperatures below -20°C (-4°F) or over $+60^{\circ}\text{C}$ ($+140^{\circ}\text{F}$).

KEEP the transceiver out of the reach of children.

KEEP the antenna cable and DC power cable as far away as possible from electrical pumps, generators and other electronic instruments to prevent instrument malfunctions.

KEEP the transceiver and microphone at least 1 meter away from your vessel's magnetic navigation compass.

DIFFERENCE	U.S.A.	U.K.
SCAN	Priority/normal	Priority only
WEATHER CHANNELS	1 to 10	None
CALL CHANNEL	Programmable	Ch 37A (fixed)
CALL SWITCH LABEL	9	C
CHANNEL SWITCH LABEL	U/WX	I/U

• PRIORITIES

- 1) Read all rules and regulations pertaining to priorities and keep an up-to-date copy handy. Safety and distress calls take priority over all others.
- 2) You must monitor channel 16 when you are not operating on another channel.
- 3) False or fraudulent distress calls are prohibited under law.

• PRIVACY

- 1) Information overheard but not intended for you cannot lawfully be used in any way.
- 2) Indecent or profane language is prohibited.

• RADIO LICENSES

(1) SHIP STATION LICENSE

When your craft is equipped with a VHF FM transceiver, you must have a current radio station license before using the transceiver. It is unlawful to operate a ship station which is not licensed.

Inquire through your dealer or the appropriate government agency for a Ship-Radiotelephone license. This license includes the call sign which is your craft's identification for radio purposes.

(2) OPERATOR'S LICENSE

A Restricted Radiotelephone Operator Permit is the license most often held by small vessel radio operators when a radio is not required for safety purposes. You can usually obtain this permit by mail.

The Restricted Radiotelephone Operator Permit must be posted near the transceiver or be kept with the operator. Only a licensed radio operator may operate a transceiver.

However, non-licensed individuals may talk over a transceiver if a licensed operator starts, supervises, ends the call and makes the necessary log entries.

A current copy of the applicable government rules and regulations is only required to be on hand for vessels in which a radiotelephone is compulsory. However, even if you are not required to have these on hand it is your responsibility to be thoroughly acquainted with all pertinent rules and regulations.

■ Front panel

DUAL/TRI-WATCH SWITCH [DUAL • □ •SCAN]

- Activates dual or tri-watch. (p. 13)
- Push and hold for 1 sec. to start a scan. (p. 11)
- While pushing [HI/LO], specifies the selected channel as a lockout channel. (p. 11)

MEMORY CHANNEL SWITCH [MR•MW]

- Selects memory channels. (p. 7)
- Push and hold to program memory channels (p. 19)

CHANNEL SELECTOR [CHANNEL]

Selects an operating channel. (p. 7)

HIGH/LOW POWER SWITCH [HI/LO•DIM]

- Toggles between high and low output powers. (p. 8)
- While pushing, rotate the channel selector to adjust the display and control/switch backlighting intensity. (p. 20)

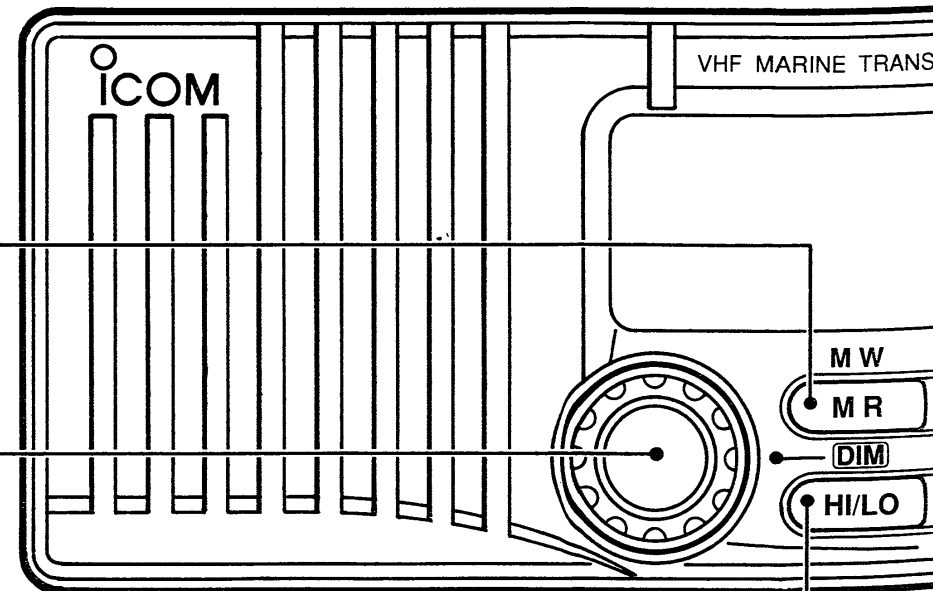

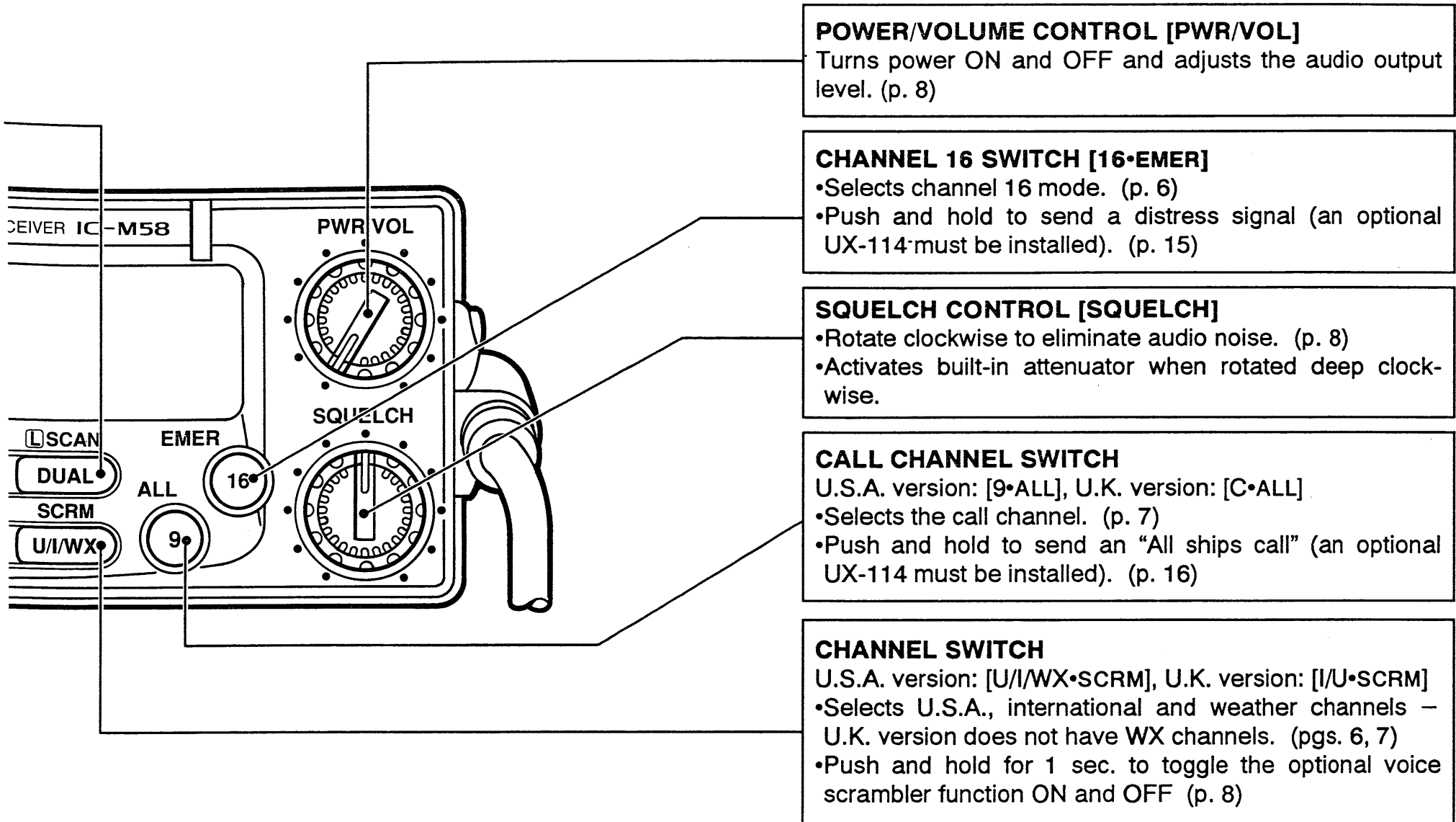

2 PANEL DESCRIPTION

■ Function display

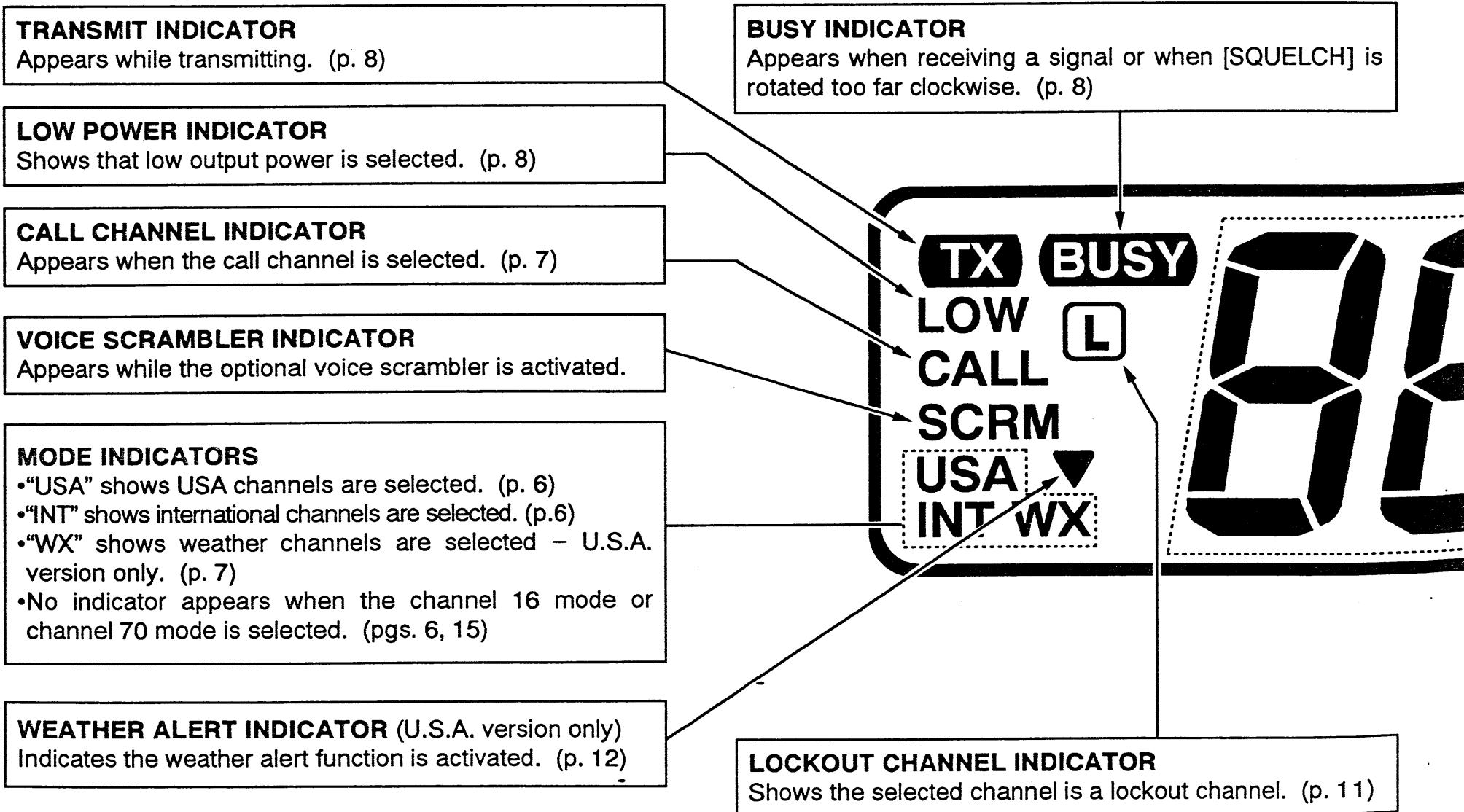

DUAL/TRI-WATCH INDICATORS

Blink while dual/tri-watch is activated. (p. 13)
 •“DUAL” blinks during dualwatch.
 •“DUAL” and “▼” blink during tri-watch.

DSC INDICATORS

One or more of these indicators appear while activating a DSC (digital selective calling) function. (pgs. 14–18)

MEMORY INDICATOR

Appears while in memory mode. (p. 7)

MEMORY NUMBER INDICATOR

•Shows the selected memory number. (p. 7)
 •“b” is indicated when the connected battery capacity is exhausted.

NMEA INDICATOR

Appears when NMEA devices are connected. (p. 25)

DUPLEX INDICATOR

Shows the selected channel is a duplex channel.

CHANNEL INDICATOR

Shows the operating channel. (pgs. 6, 7)

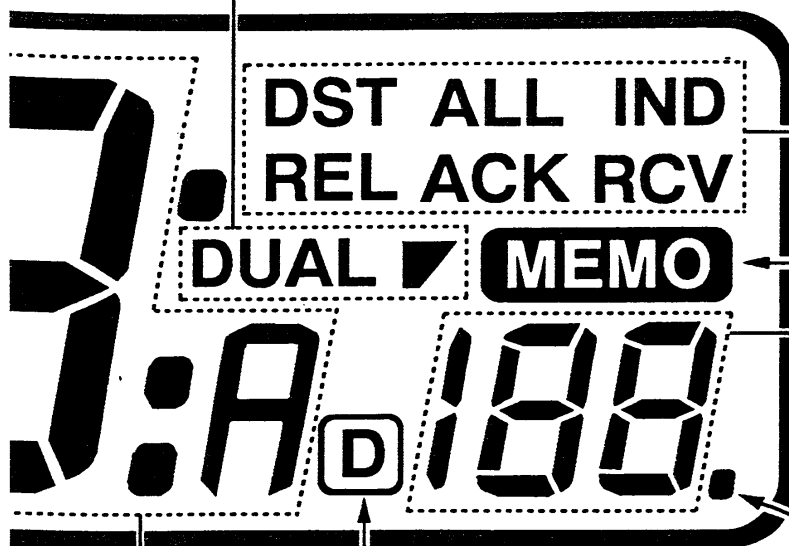

3

BASIC OPERATION

Power ON

① Rotate [PWR/VOL] clockwise to turn power ON.

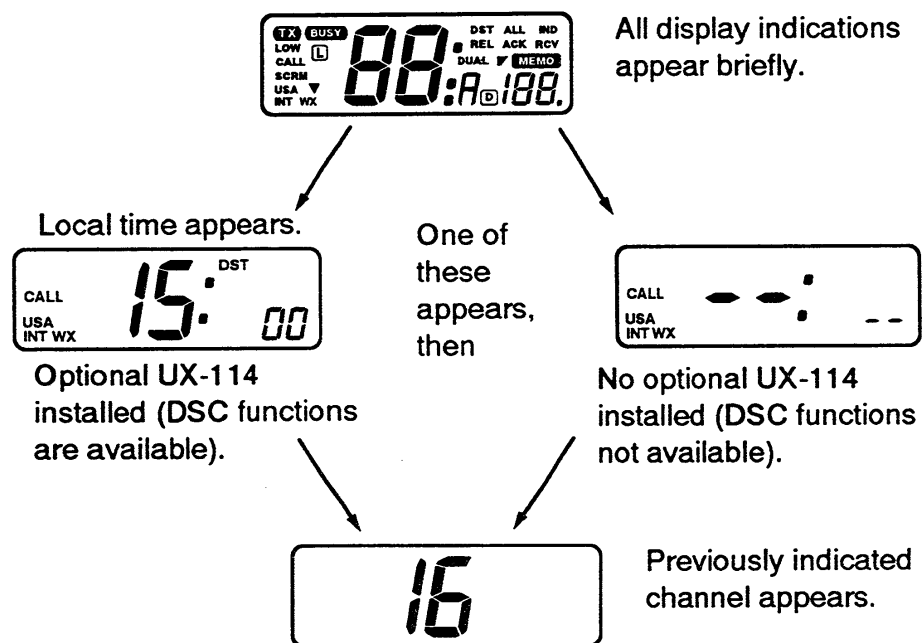

② Operate the transceiver as indicated in the following sections.

Channel selection

◇ CHANNEL 16

Channel 16 is the distress and calling channel. It is used for establishing initial contact with another station and for emergency communications. While standing by you are required to monitor channel 16.

Push **16**



or

Hang the mic on the mic hanger.

[CHANNEL] rotation selects previous channel.



Only "16" appears.

◇ USA CHANNELS

There are 58 USA channels. Establish initial contact on channel 16, then move to an agreed upon channel for communications. Some channels can only transmit at low power (see the channel list, p. 29).

Push **U/I/WX**



or

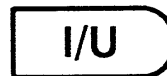



one or more times, then rotate [CHANNEL] to select a channel.



"USA" indicates that a channel in the U.S.A. channel group is selected.

◇ INTERNATIONAL CHANNELS

There are 85 international channels. Establish initial contact on channel 16, then move to an agreed upon channel for communications (some channels are low power only, p. 29).



Push  or  one or more times, then rotate [CHANNEL] to select a channel.



"INT" indicates that a channel in the international group is selected.

◇ CALL CHANNEL

The call channel is used to store your most often-used channel for quick recall. In addition, the call channel is monitored during tri-watch. The call channel is fixed at 37A for the U.K version; the default for the U.S.A. version is 9.

Push  or  [CHANNEL] rotation selects the previously selected channel.



"CALL" indicates that the call channel is selected.

◇ WEATHER CHANNELS (U.S.A. version only)

In North American waters, there are 10 NOAA weather channels which broadcast local weather forecasts and issue weather advisories. These channels are for receive ONLY.

Push  one or more times, then rotate [CHANNEL] to select a channel.



"WX" indicates that a weather channel is selected.

◇ MEMORY CHANNELS

24 memory channels are used to store often-used channels for easy recall and scanning.

Push  [CHANNEL] rotation selects programmed memory channels only (p. 19).



"MEMO" indicates that a memory channel is selected.

3 BASIC OPERATION

■ Receiving

- ① Rotate [PWR/VOL] to turn power ON.
- ② Rotate [SQUELCH] fully counterclockwise.
- ③ Adjust [PWR/VOL] to a suitable listening level.
- ④ Rotate [SQUELCH] clockwise until the audio noise disappears.
- ⑤ Select the desired channel. See pgs. 6–7 for details.
 - When a signal is received:
 - The squelch opens.
 - Audio is emitted from the speaker.
 - “BUSY” appears in the function display.
- ⑥ When an interrupting signal is received, rotate [SQUELCH] deeply clockwise.



◇ RECEIVING A SCRAMBLED SIGNAL

In order to understand scrambled signals, an optional UT-79 must be installed.

Push [U/I/WX•SCRM] for 1 sec. to turn the voice scrambler ON.

- “SCRM” appears in the display.
- See p. 20 for details on setting a scramble code.
- Repeat the above step to turn the function OFF.

■ Transmitting

Before transmitting a signal, read call procedures on p. 9.

- ① Select an operating channel. See p. 6–7 for details.
- ② Push [HI/LO] to select transmit output power.
 - “LOW” appears when low output power is selected.
 - Transmission is restricted on some channels. See p. 9.
 - For privacy activate the optional voice scrambler function (see left below) and set a scramble code (p. 20).
- ③ Push and hold the PTT switch to transmit.
 - “TX” appears.
- ④ Speak into the microphone at your normal voice level.
 - Do not hold the microphone too closely to your mouth or speak too loudly. This may distort the transmit signal.
- ⑤ Release the PTT switch to receive.

/// **IMPORTANT:** In order to maximize the readability of your transmitted signal, pause for a moment after pushing [PTT], hold the microphone 15–20 cm from your mouth, then speak into the microphone at an even, normal voice level.

CALL PROCEDURES

You must identify yourself when you transmit and you must respect time limits.

- 1) Give your call sign each time you call another vessel or a coast station. If you have no call sign, identify the station by giving the vessel name and the name of the license.
- 2) Give your call sign at the end of each transmission that lasts more than 3 minutes.
- 3) You must pause and give your call sign at least once every 15 minutes during long ship-to-shore calls.
- 4) Keep your calls short (less than 3 minutes). Wait 2 minutes before repeating a call.
- 5) Unnecessary transmissions are not allowed.

LOW VOLTAGE NOTE

When “**b**” appears as shown at right, there is a DC power source problem. In this case, check your vessel’s battery and DC power cable.



TRANSMITTER RESTRICTIONS

CHANNEL NUMBER	U.S.A. CHANNELS	INTERNATIONAL CHANNELS
13	Momentary high power*	No restriction
15	Receive only	Low power only
17	Low power only	
67	Momentary high power*	No restriction
70	Low power only (no voice)	
Weather channels	Receive only	

***Momentary high power**

On these channels, transmissions using high power are momentarily possible. To use high power, push and hold [HI/LO] while transmitting.

TIME-OUT TIMER (TOT) – U.S.A. only

The transceiver has a TOT to prevent continuous, long transmissions. Transmit is automatically inhibited after 5 min. of continuous transmission.

General

The IC-M58 has normal and priority scans* (selectable in SET mode) for each group of channels. In addition, lockout channels can be set for any of these scans.

8 different scans (with or without lockout channels) are possible with the transceiver as follows:

*Priority ONLY for the U.K. version .

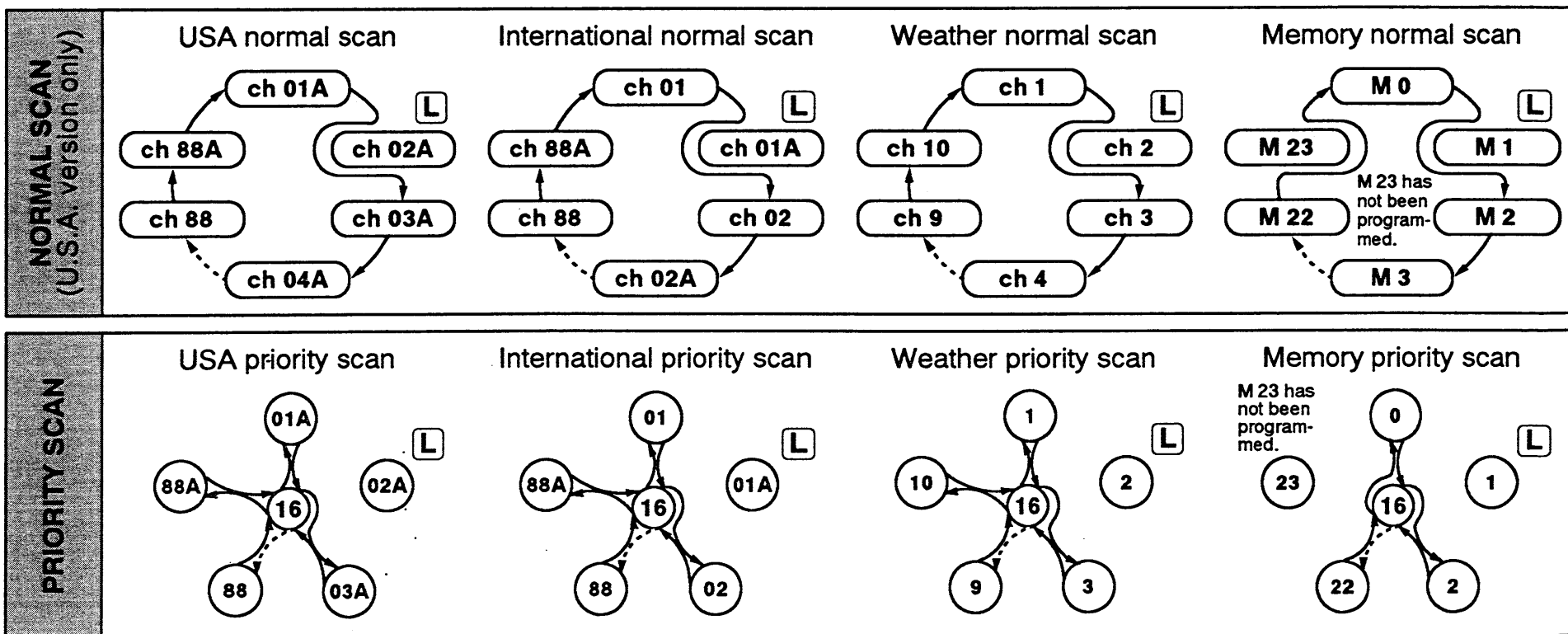

- Weather scans do not apply to the U.K. version.
- “L” shows that the channel is a lockout channel.
- Transmitting (pushing PTT) cancels the scan.



- Normal scan pauses on a signal and resumes according to the scan timer setting in SET mode (p. 23).
- Priority scan becomes dual watch while receiving a signal and pauses for any signals on channel 16.

• SCAN START/STOP

Select normal or priority scan in SET mode, then:

- ① Select the desired channel group.
 - To select U.S.A., international or weather channels, push [U/I/WX] one or more times.
 - To select memory channels, push [MR].
- ② Lock out or unlock channels depending on your preference. (See below.)
- ③ Rotate [SQUELCH] clockwise until the audio noise disappears.
- ④ Push and hold [DUAL•SCAN] for 1 sec. to start the scan.
 - The scan indicator (a dot) blinks while scanning.
- ⑤ When a signal is received, scan pauses for 5 secs., then resumes (this can be changed in SET mode – p. 23).
 - When priority scan is selected in SET mode, dualwatch starts.
- ⑥ Push [DUAL•SCAN] again to stop the scan and remain in the same channel group.
 - Push [16] to stop the scan and select channel 16.
 - Transmitting (pushing [PTT]) also stops the scan.

PROGRAMMING A LOCKOUT CHANNEL

- ① Select the desired channel group.
- ② Select the channel to be locked out using the channel selector.
- ③ While pushing [HI/LO], push [DUAL•SCAN] to lockout the channel.
 - “” appears.
- ④ To cancel the lockout, repeat step ③.
 - “” disappears.

[EXAMPLE]: Locking out USA channel 06.

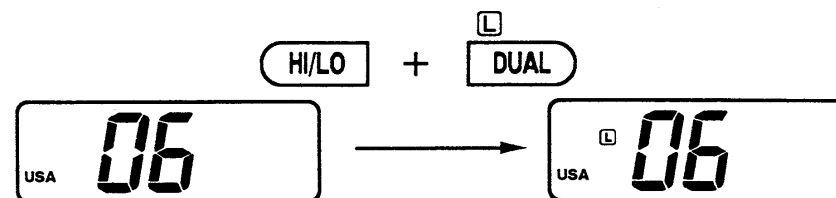

[EXAMPLE]: Locking out memory 15.

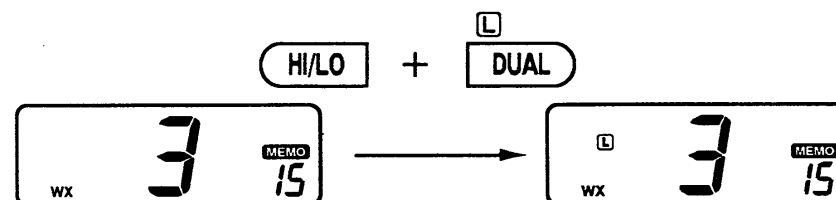

4 SCANS

■ Weather alert (U.S.A. version only)

When the IC-M58 catches a weather alert tone on a weather channel while scanning, the transceiver sounds an alert beep to indicate that an emergency weather report is on the air.

• TURNING THE FUNCTION ON AND OFF

Enter SET mode to turn the function ON or OFF. (Refer to p. 23)

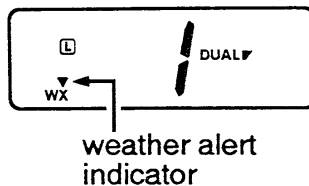

The weather alert function is available only while scanning channels which include weather channels. The weather alert does not function while scanning non-weather channels, even when “▼” appears.

What is the weather alert tone?

The NOAA weather radio broadcasts are continuous, pre-recorded broadcasts. In case of a local weather emergency, the broadcast becomes live. Before this live broadcast, a warning tone (1050 Hz) is transmitted.

• ACTIVATING THE FUNCTION

- ① Turn the weather alert function ON.
 - See left and SET mode (p. 23) for details.
- ② Push [U/I/WX] one or more times to select weather channels, then, push and hold [DUAL•SCAN] for 1 sec. to start weather scan.
 - Memory scans can also be used. See below.
- ③ When the transceiver catches an alert tone on a weather channel, a 1 sec. beep sounds and the scan automatically stops on the channel to receive the emergency weather report.
- ④ To cancel the scan manually, push [DUAL•SCAN] again.

NOTE: While scanning on the weather channels with the weather alert function ON, the scan does not pause for normal signals (except for signals on ch 16 during priority scan).

CONVENIENT

If weather channels have been programmed into memory channels, use a memory scan with the weather function ON. The scan pauses for signals on USA or international channels and stops with a beep for an alert tone on weather channels.

Dualwatch/tri-watch

Dualwatch monitors ch 16 while you are receiving another channel; tri-watch monitors ch 16 and the call channel while receiving another channel. Select dual watch or tri-watch in advance using SET mode (see p. 22).

- ① Select the desired operating channel.
- ② Push [DUAL] to start dualwatch/tri-watch.
 - “DUAL” blinks during dualwatch; “DUAL ▽” blink during tri-watch.
 - Tri-watch becomes dualwatch when receiving a signal on the call channel.
- ③ To cancel dualwatch/tri-watch, push [DUAL] again.
 - “DUAL” or “DUAL ▽” disappears.

DUALWATCH/TRI-WATCH SIMULATION

Dualwatch

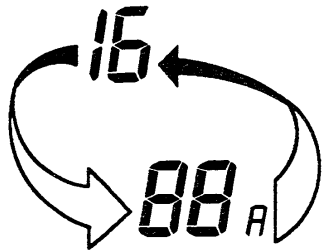

Tri-watch
Call channel (programmable for U.S.A. version only.)

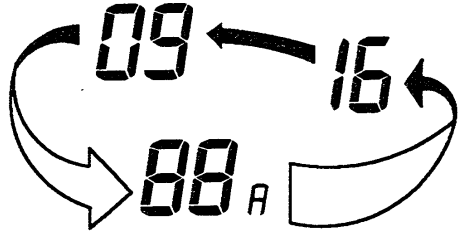

- If a signal is received on channel 16, dualwatch/tri-watch pauses on channel 16 until the signal disappears.
- If a signal is received on the call channel during tri-watch, tri-watch becomes dualwatch until the signal disappears.
- To transmit on the selected channel during dualwatch/tri-watch, push and hold [PTT].

[EXAMPLE]: Operating tri-watch on USA channel 07A.

Push **DUAL**

Tri-watch starts.

Signal received on call channel.

Signal received on ch 16 takes priority.

Tri-watch resumes after the signal disappears.

■ General

Digital Selective Calling (or DSC) is a method of radio communications involving digital signals rather than the more conventional method of voice communications. The advantage of using digital communications over voice communications is that information (especially useful for distress calls and other urgent matters) can be pre-programmed into a radio and transmitted quickly and accurately. For example, at the push of a switch, a vessel's identity, position (latitude and longitude) and the time, etc. can be transmitted. Because of the digital nature of the communications, future implementations of DSC could involve much more detailed information transmission.

With the installation of an optional UX-114 DSC UNIT, the IC-M58 meets U.S. Coast Guard proposal SC-101, and can transmit and receive DSC signals in addition to other functions. The table at right lists the DSC functions possible when the optional UX-114 is installed. Refer to p. 25 for connections.

DSC FUNCTION OVERVIEW	
Distress call	Vessel ID, time and position* are transmitted as digital signals.
Distress call (RX)	Sounds emergency beeps when selecting ch 70 and receiving a distress call.
Distress relay call (RX)	"DST REL" appears when selecting ch 70 and receiving a distress relay call.
All ships call (Tx)	Controls the <i>large ships standby channel</i> for contact with them.
All ships call (RX)	Channel control signal can be received when selecting ch 70.
Individual call (RX)	"IND" appears when selecting ch 70 and receiving your individual address code.
Sensor distress call (TX)†	When a connected sensor detects an emergency condition, a distress call is automatically transmitted.

*When NMEA equipment is connected.

†When sensors (eg. for fire, water, etc.) are connected.

Distress call

- ① Push and hold [16•EMER] for 5 secs.
 - The transceiver automatically selects channel 70, an alert beep sounds 5 times and any connected external alarm devices are activated.
- ② Release [16•EMER].
 - When a shore station (or another vessel with DSC encoding/decoding capability) receives your distress call, an acknowledgement is transmitted back to you and "ACK" and "RCV" appear momentarily. After that, the transceiver automatically selects channel 16.
 - If no acknowledgement is received after 25 secs., the transceiver automatically selects channel 16.
- ③ Wait for a voice reply on channel 16.
- ④ While pushing [PTT], transmit your distress message to the responding party.
 - When [PTT] or [16] is not pushed within 3.5 mins. of sending a DSC distress call, and no "ACK" is received, ch 70 is automatically selected and your DSC signal is retransmitted.

◇ To remove "DST" from the function display, turn power OFF, then ON again.

NOTE: When a navigation receiver with NMEA 0183 output capability is connected, your vessel's position is automatically transmitted with the distress call.

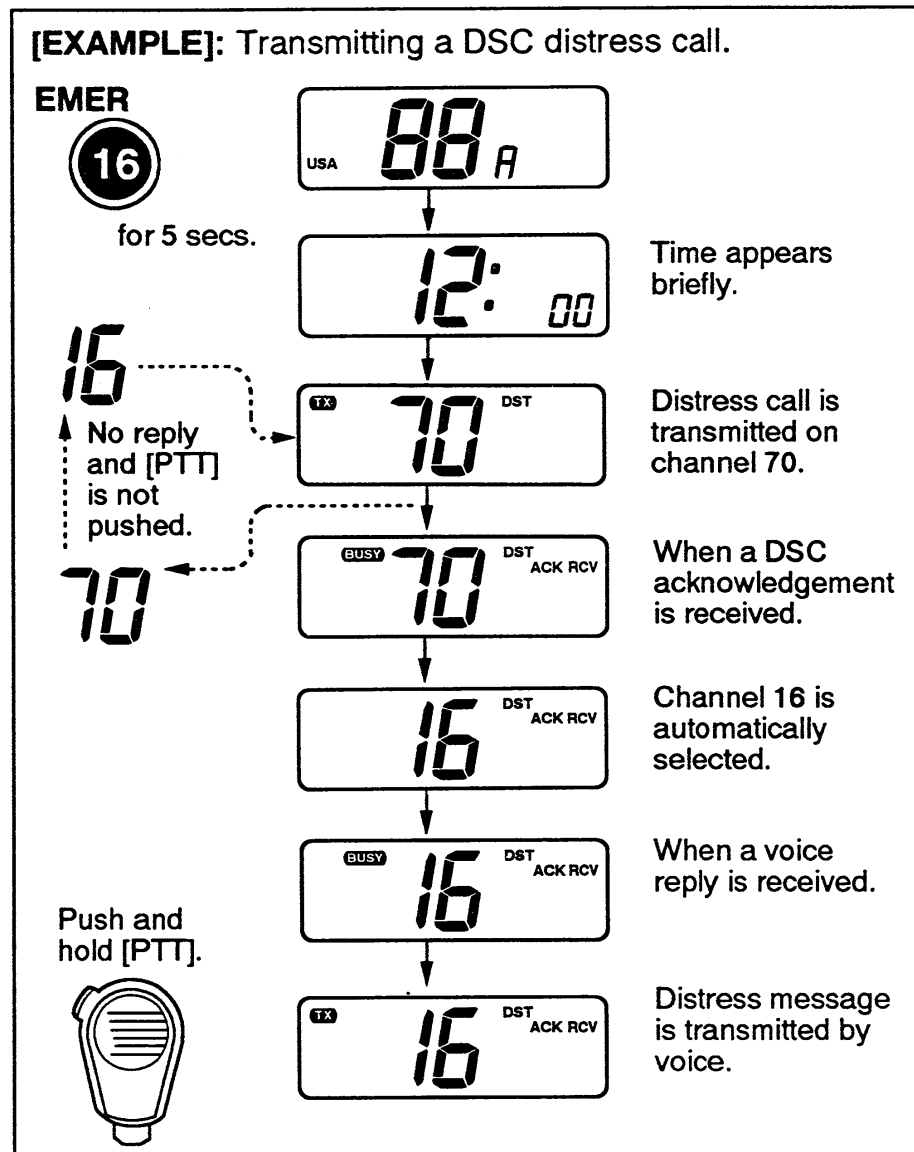

5 DIGITAL SELECTIVE CALLING

■ All ships call (TX)

Large ships use channel 70 as their “listening channel.” When you want to contact one of these ships, use the “all ships call” function.

- ① Select a simplex channel to communicate on.
 - Some 'A' channels (eg. channel 88A) cannot be used.
- ② Rotate [SQUELCH] clockwise until the audio noise disappears.
- ③ Push [9•ALL] or [C•ALL] for 5 secs.
 - Channel 70 is automatically selected, “ALL” appears on the display and the channel data you selected in ① is transmitted at low power.
 - When channel 70 is busy, the transceiver waits until the channel clears, and then sends the “all ships call”; when you want to cancel the function, push any switch.
 - After transmission, the previous channel is selected.
- ④ Push and hold [PTT] to communicate your message to the responding party.

NOTE: An “all ships call,” after transmitting a distress call, includes emergency data. In this case, the “all ships call” acts as a distress call and alerts other vessels to your situation.

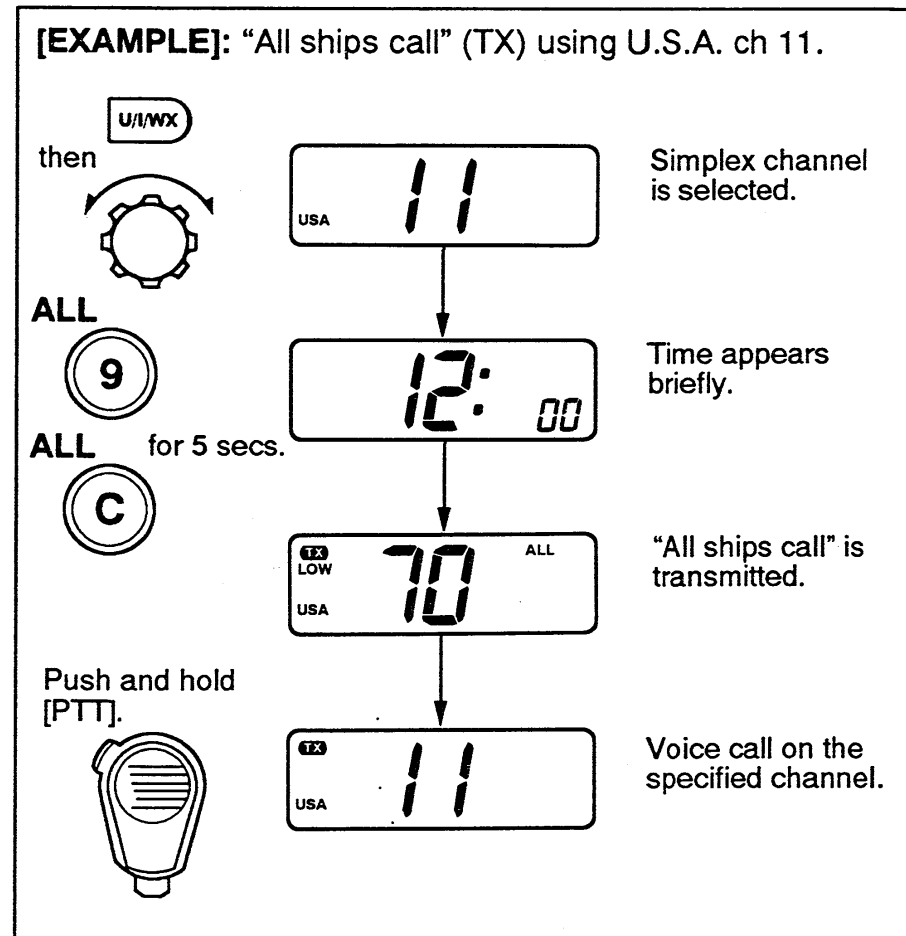

■ All ships call (RX)

To receive an “all ships call” transmission, channel 70 must be monitored.

- ① Select channel 70.
- ② When receiving an “all ships call,” a specified channel and “ALL”/“RCV” appear on the function display.
 - The transceiver automatically selects the specified channel.
- ③ Wait for a voice call on the specified channel.
- ④ If you are contacted by voice, push [PTT] to reply.
 - “RCV” and “ALL” disappear.
 - Some other switches also remove “RCV” and “ALL” from the display.

NOTE: When receiving an “all ships call” from a vessel that has previously transmitted a DSC distress call, emergency beep alerts sound.

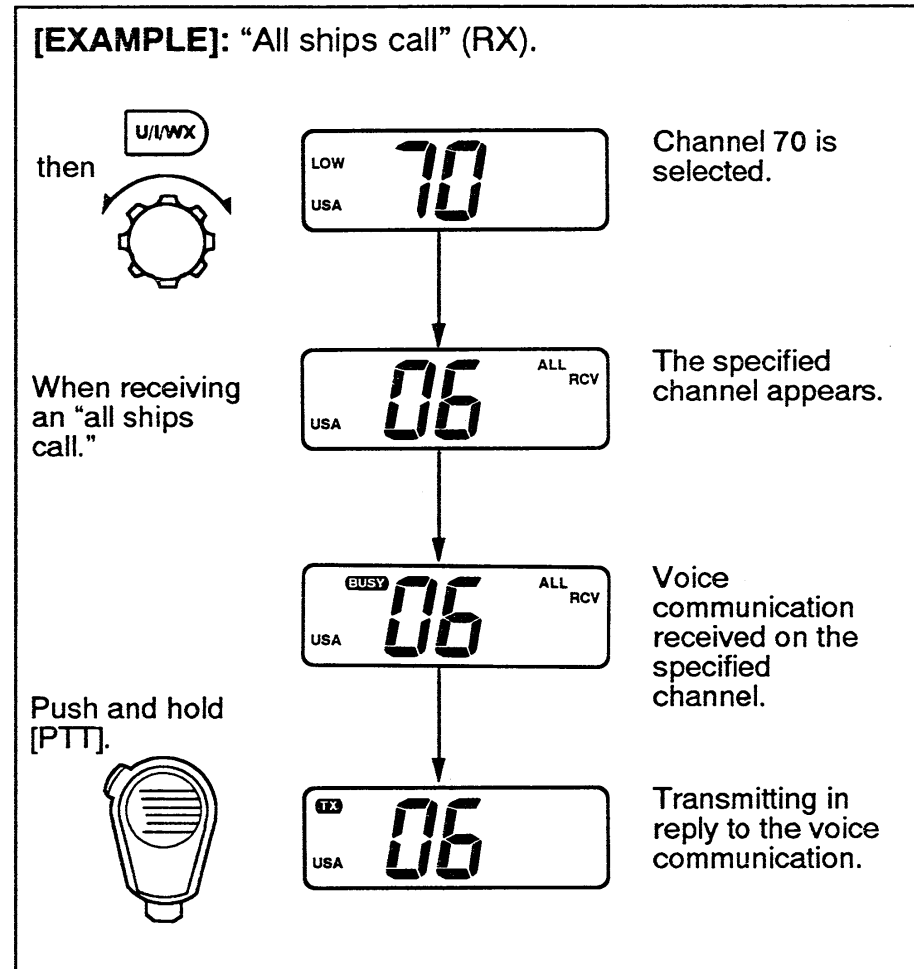

5 DIGITAL SELECTIVE CALLING

■ Sensor distress call (TX)

When sensors are connected, the IC-M58 will alert you to abnormal conditions eg. fire, water ingress, etc.

When a sensor detects an abnormal condition, the transceiver emits alert beeps for 25 secs. After 30 secs. have elapsed, a DSC distress call is transmitted on channel 70. See pgs. 15–17 for DSC distress call details.

- When connected, external alarm devices are activated.

■ Individual call (RX)

The IC-M58 is capable of receiving DSC signals addressed to your vessel's DSC ID, while you are monitoring channel 70.

◇ “RCV” and “IND” appear.

- The transceiver automatically sends an acknowledgement and selects the specified channel.

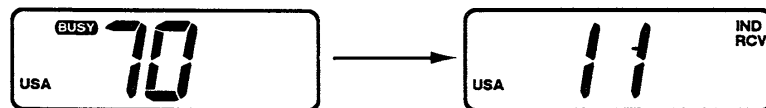

■ Distress call (RX)

The IC-M58 can receive DSC distress calls sent from shore (or ship) stations.

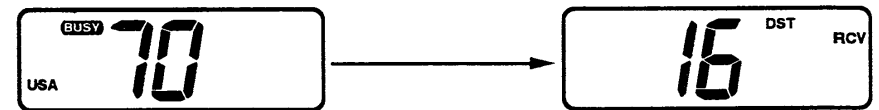

- When receiving a DSC distress call, emergency beep alerts sound.

■ Distress relay call (RX)

When you are monitoring channel 70, the IC-M58 can receive DSC distress relay calls which have been relayed through a shore (or ship) station. In this case, the following display appears briefly before channel 16 is automatically selected.



- When receiving a DSC distress relay call, emergency beep alerts sound.

Memory channels

◇ To program:

- ① Push and hold [MR•MW] for 2 sec.
 - The memory channel number blinks.
- ② Rotate the channel selector to select the desired memory.
- ③ Push [U/I/WX] to select a channel group (U.S.A., international, weather). (See pgs. 6–7)
 - The channel number blinks.
- ④ Rotate the channel selector to select the channel you wish to program.
- ⑤ Push [MR] to complete the programming.
 - Memory mode is automatically selected.
- ⑥ To program additional memories, repeat from step ①.

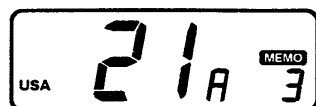
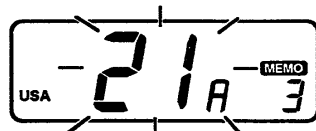
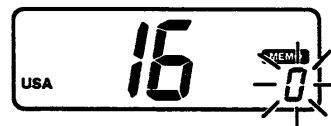

Call channel

◇ To program (U.S.A. version only):

- ① Push [9] to select the call channel.
- ② While pushing [HI/LO], push and hold [9] for 1 sec.
 - The call channel and channel group indicator blink.
- ③ Push [U/I/WX] one or more times to select international, USA or weather channels.
- ④ Rotate the channel selector to select the channel you wish to program.
- ⑤ Push [9] to complete the programming and select the call channel.

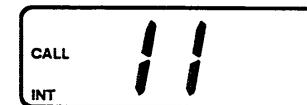

NOTE: Output power can be programmed into a memory channel. Push [HI/LO] while the channel number blinks to program.

■ Voice scrambler Optional UT-79 required

To transmit or receive scrambled signals, the voice scrambler function **MUST** be turned ON. (See p. 8) In addition, all members of a group **MUST** have the same scramble code programmed.

NOTE: The voice scrambler function does not operate on channel 16.

◇ To set a scramble code:

① Turn the voice scrambler function OFF if it is ON.

- Pushing and holding [U/I/WX•SCRM] for 1 sec. toggles the function ON and OFF.

② While pushing and holding [U/I/WX•SCRM], rotate the channel selector to select the desired code.

- The first "click" when rotating the channel selector displays the currently set code.
- 0 to 127 can be set as codes.



"SCRM" disappears



Current code



New code selected

■ Display backlighting

The function display and switches can be backlit for better visibility under low light conditions.

While pushing [HI/LO•**DIM**], rotate the channel selector to adjust the backlighting.

- Backlighting can be set to 1 of 3 intensities or turned OFF.
- While the power saver is activated (see below), the display backlighting automatically turns OFF. However, when the power saver is temporarily canceled (such as when receiving a signal), the backlighting comes back ON again.

■ Power saver Using SET mode

A power saver function is available and can be turned ON and OFF in SET mode (p. 22).

The power saver function conserves battery power by resting the transceiver's receive circuit at specified intervals during stand by. This is useful when using the transceiver with your vessel's engine turned OFF.

■ Entering SET mode

SET mode is used to customize operation of the transceiver to suit your operating needs.

◇ To enter SET mode:

- ① While pushing [HI/LO], turn power ON.
 - Keep pushing [HI/LO] until the initial SET mode display appears.
 - SET mode is selected.
- ② To exit SET mode, push [16] or turn power OFF, then ON again.

◇ To select an item:

There are up to 8 items in SET mode (depending on options installed) that may be adjusted to suit your operating needs.

- ① Enter SET mode as above.
- ② Push [HI/LO] to select the desired item; then rotate [CHANNEL] to select the desired condition.
 - See the following pages for details on each SET mode item.

▨ The diagram at right shows the default settings for each SET mode item and the order of selection.

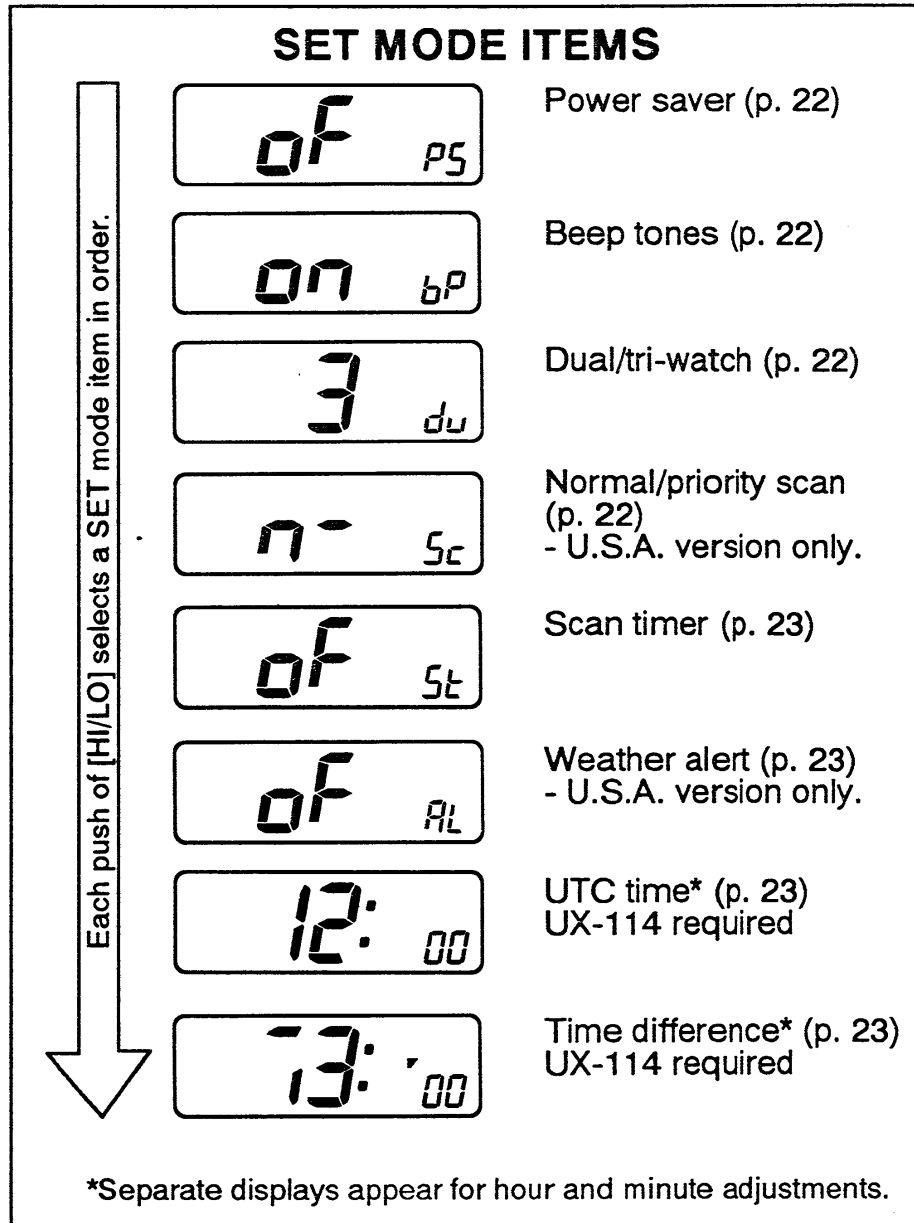

8 SET MODE

◇ POWER SAVER

This item sets the power saver function ON or OFF.
(See p. 20)

Power saver OFF (default)

of PS

on PS

Power saver ON

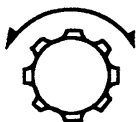

◇ BEEP TONES

This item sets the transceiver's confirmation beep tones
(when pushing a switch/rotating [CHANNEL]) ON or OFF.

Beep tones ON (default)

on bP

of bP

Beep tones OFF

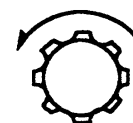

NOTE: DSC alert tones and
the WX alert tone CANNOT
be turned OFF.

◇ DUAL/TRI-WATCH

This item sets the watch function to dual or tri-watch.

Tri-watch (default)

3 du

2 du

Dualwatch

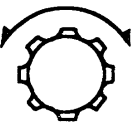

◇ NORMAL/PRIORITY SCAN (U.S.A. version only)

This item sets the scan function to normal or priority
operation. (See p. 10)

Normal scan (default)

n- SC

p- SC

Priority scan

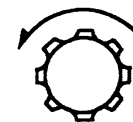

◇ **SCAN TIMER**

This item sets the scan timer ON or OFF.

Scan timer OFF (default)



- Scan pauses on a signal and resumes 2 sec. after it disappears.



Scan timer ON

- Scan pauses on a signal and resumes 5 sec. later.

◇ **WEATHER ALERT (U.S.A. version only) -**

This item sets the weather alert function ON or OFF.
(See p. 12)

Weather alert OFF (default)

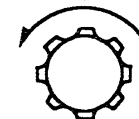

Weather alert ON

◇ **UTC (UNIVERSAL TIME COORDINATED)**

This item sets the transceiver's internal clock to UTC time (an optional UX-114 is required) for distress calls.



- Rotate [CHANNEL] to adjust the hours (24-hour clock).



- Rotate [CHANNEL] to adjust the minutes.
-Seconds are reset to zero.

◇ **TIME DIFFERENCE**

This item sets the time difference between local time and UTC so that the local time is displayed during DSC operation (an optional UX-114 is required).

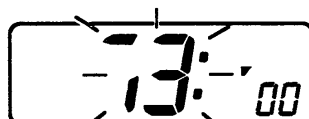

- Rotate [CHANNEL] to adjust the hours: -13 to +13.

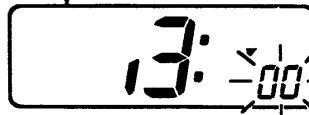

- Rotate [CHANNEL] to adjust the minutes.

NOTE: If 0:00 is assigned to this item, the time appearing in the function display is the same as that set for UTC.

■ Unpacking

① Mounting bracket	1
② DC power cable	1
③ Microphone hanger	1
④ Mounting bracket knobs	4
⑤ Flat washers (M4)	2
⑥ Mounting screws	4
⑦ Flat washers (M5)	8
⑧ Star washers	4
⑨ Nuts (M5)	4
⑩ Mounting screws	4
⑪ Mic hanger screws (3.5 × 3.0)	2
⑫ External speaker plug	1
⑬ Fuses (10 A)	2

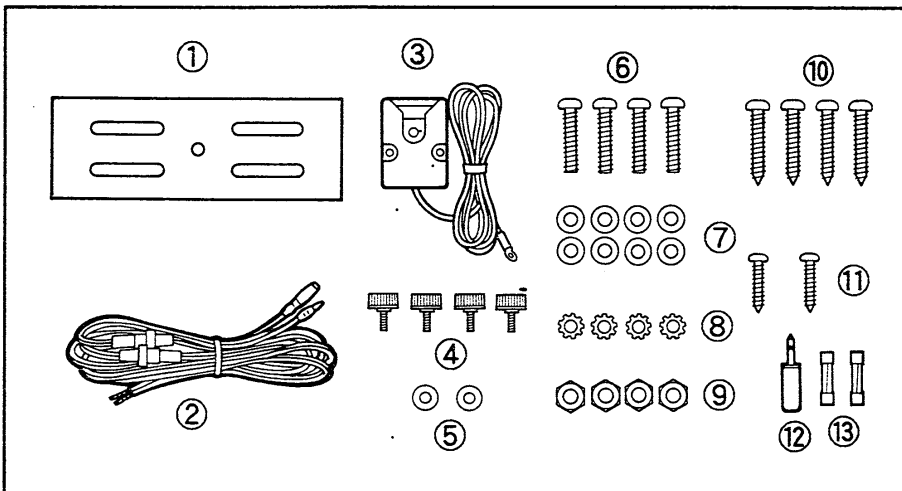

■ Additional requirements

◇ FOR GENERAL OPERATION

- Marine VHF antenna
- Coaxial cable

◇ FOR DSC OPERATION

- UX-114 DSC UNIT

◇ FOR ENHANCED DSC OPERATION

- Navigation receiver with NMEA0183 output (such as Loran-C or GPS) for sending positioning data with a distress call
- One or more external alarm devices to alert you when you are away from the transceiver
- One or more sensors for sensor distress calls

◇ FOR VOICE SCRAMBLER OPERATION

- UT-79 VOICE SCRAMBLER UNIT

■ Connections

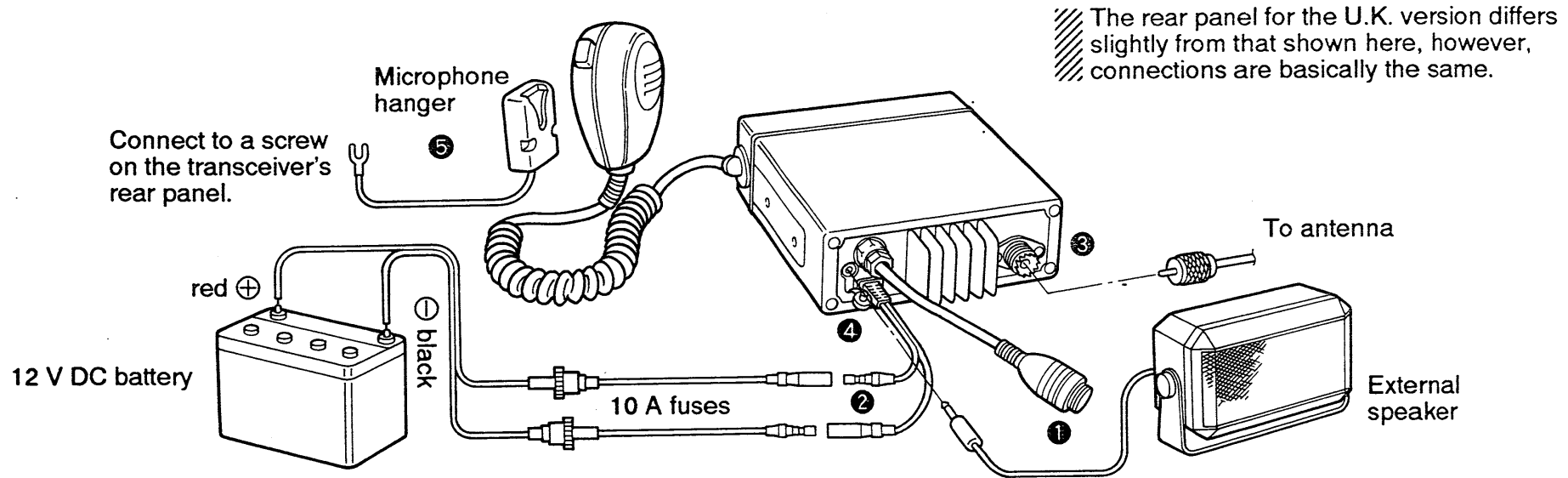

① DSC CONNECTOR (optional UX-114)

7-pin plug connects a navigation receiver for transmission of position data, sensor(s) for the sensor distress call and/or emergency alarm device(s).

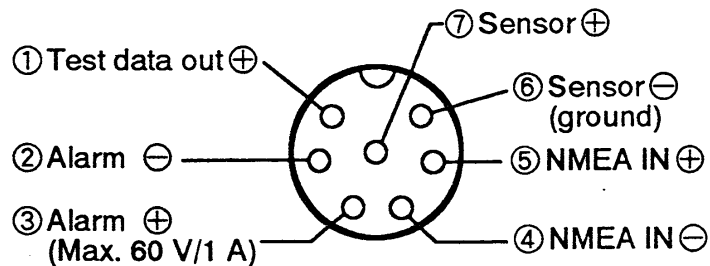

② DC POWER CONNECTOR

Connects the supplied DC power cable from this connector to an external 12 V DC power source.

③ ANTENNA CONNECTOR

Connects a marine VHF antenna with a PL-259 connector to the transceiver.

CAUTION: Transmitting without an antenna will damage the transceiver.

④ EXTERNAL SPEAKER JACK

⑤ MICROPHONE HANGER

Connects to the transceiver's ground. Resting the mic on the hanger automatically selects channel 16.

9 CONNECTIONS AND MAINTENANCE

■ Mounting the transceiver

The universal mounting bracket supplied with your transceiver allows overhead or dashboard mounting. Please read the following instructions carefully.

- Mount the transceiver securely with bolts and nuts or it may come loose as a result of wave shocks or vibration.
- Mount the transceiver so that the face of the transceiver is at 90 degrees to your line of sight when operating it.

CAUTION: KEEP the transceiver and microphone at least 1 meter away from your vessel's magnetic navigation compass.

NOTE: Check the installation angle; the function display may not be easy-to-read at some angles.

NOTE: When installing an optional UX-114 DSC UNIT, attach the WARNING sticker supplied with the UX-114 near the transceiver's front panel so that it is clearly visible during operation.

■ Antenna

A key element in the performance of any communication system is an antenna. Ask your dealer about antennas and the best places to mount them.

DASHBOARD MOUNTING

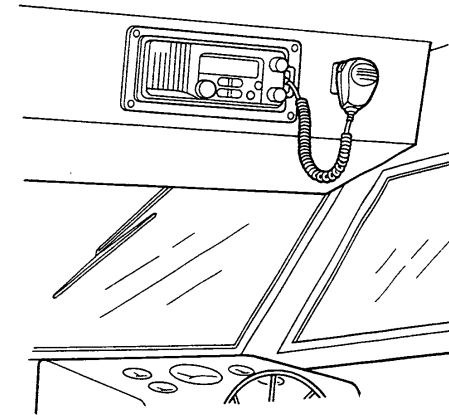

An optional MB-28 is available for mounting the transceiver as above.

OVERHEAD MOUNTING

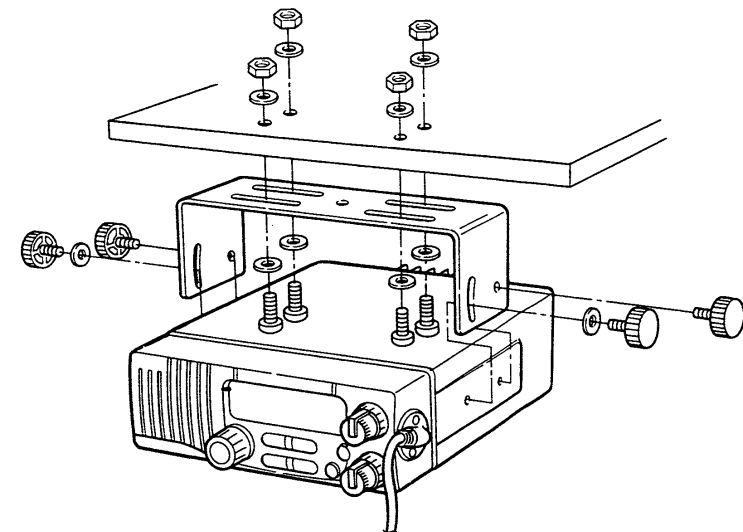

■ Fuse replacement

Two fuses are installed in the supplied DC power cable. If a fuse blows or the transceiver stops functioning, track down the source of the problem, if possible, and replace the damaged fuse with a new, rated fuse.

- Fuse rating : 10 A

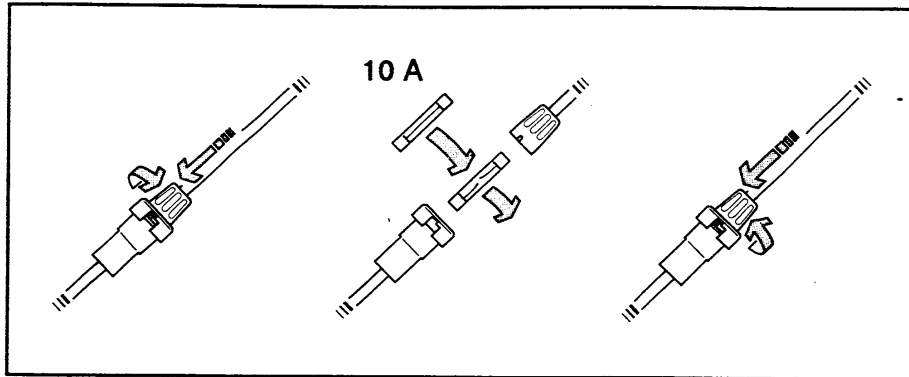

■ Backup battery

The IC-M58 has no backup battery. However, the optional UX-114 has a backup battery to maintain the time. Memory channel contents, etc. are maintained by EEPROM. The normal life of this EEPROM is over 100 years and therefore should never need replacing. If you have reason to believe the EEPROM may be faulty, have a qualified Icom Dealer or Service Technician look at it.

■ Cleaning

If the transceiver becomes dusty or dirty, wipe it clean with a dry, soft cloth.

AVOID the use of solvents such as benzene or alcohol, as they may damage transceiver surfaces.

10 TROUBLESHOOTING

PROBLEM	POSSIBLE CAUSE	SOLUTION	REF.
No power comes ON.	<ul style="list-style-type: none"> • Power cord not connected correctly. • Blown fuse. 	<ul style="list-style-type: none"> • Check the power cord connection. • Check the polarity of the power connection, then, replace the fuse. 	p. 25 p. 27
No sound comes from the speaker.	<ul style="list-style-type: none"> • Handset is out of the cradle (when an optional handset is used). 	<ul style="list-style-type: none"> • Set the handset into the cradle. 	—
Sensitivity is low and only strong signals are audible.	<ul style="list-style-type: none"> • [SQUELCH] is rotated too far clockwise. 	<ul style="list-style-type: none"> • Rotate [SQUELCH] counterclockwise to a suitable position. 	—
Transmitting is impossible or high power cannot be selected.	<ul style="list-style-type: none"> • Transmission is restricted on some channels. 	<ul style="list-style-type: none"> • Change channels. 	p. 8
The displayed channel cannot be changed.	<ul style="list-style-type: none"> • The channel 16 mode has been selected. • Dual/tri-watch has been activated. • Scan has been activated. 	<ul style="list-style-type: none"> • Select another mode. • Push [DUAL] to cancel dual/tri-watch. • Push [DUAL•SCAN] to cancel the scan. 	p. 6 p. 13 p. 11
The memory number cannot be changed.	<ul style="list-style-type: none"> • Other memories have not been programmed. 	<ul style="list-style-type: none"> • Program at least 2 memories. 	p. 19
Scanning or dualwatch/tri-watch does not function.	<ul style="list-style-type: none"> • The channel 16 mode has been selected. • The squelch is open. 	<ul style="list-style-type: none"> • Select another mode. • Rotate [SQUELCH] clockwise. 	p. 6 p. 8
Scan does not pause on some weather channels.	<ul style="list-style-type: none"> • The weather alert function has been turned ON. 	<ul style="list-style-type: none"> • Turn the function OFF in SET mode. 	p. 23
Receive signal cannot be understood.	<ul style="list-style-type: none"> • Voice scrambler has been turned OFF. • Voice scrambler code has not been set correctly. 	<ul style="list-style-type: none"> • Push [U/I/WX•SCRM] to turn it ON. • Reset the scramble code. 	p. 8 p. 20

VHF MARINE CHANNEL LIST 11

Channel number		Frequency (MHz)	
INT	USA	Trans-cieve	Receive
01		156.050	160.850
	01A	156.050	156.050
02		156.100	160.700
	02A	156.100	156.100
03		156.150	160.750
	03A	156.150	156.150
04		156.200	160.800
	04A	156.200	156.200
05		156.250	160.850
	05A	156.250	156.250
06	06	156.300	156.300
07		156.350	160.950
	07A	156.350	156.350
08	08	156.400	156.400
09	09	156.450	156.450
10	10	156.500	156.500
11	11	156.550	156.550
12	12	156.600	156.600
13	13 *3	156.650	156.650
14	14	156.700	156.700
15 *1	15 *2	156.750	156.750
16	16	156.800	156.800
17 *1	17 *1	156.850	156.850
18		156.900	161.500
	18A	156.900	156.900

Channel number		Frequency (MHz)	
INT	USA	Trans-cieve	Receive
19		156.950	161.550
	19A	156.950	156.950
20	20	157.000	161.600
	20A	157.000	157.000
21		157.050	161.650
	21A	157.050	157.050
22		157.100	161.700
	22A	157.100	157.100
23		157.150	161.750
	23A	157.150	157.150
24	24	157.200	161.800
25	25	157.250	161.850
26	26	157.300	161.900
27	27	157.350	161.950
28	28	157.400	162.000
60		156.025	160.625
	60A	156.025	156.025
61		156.075	160.675
	61A	156.075	156.075
62		156.125	160.725
	62A	156.125	156.125
63		156.175	160.775
	63A	156.175	156.175
64		156.225	160.825
	64A	156.225	156.225

Channel number		Frequency (MHz)	
INT	USA	Trans-cieve	Receive
65		156.275	160.875
	65A	156.275	156.275
66		156.325	160.925
	66A	156.325	156.325
67	67 *3	156.375	156.375
68	68	156.425	156.425
69	69	156.475	156.475
70 *1	70 *1	156.525	156.525
71	71	156.575	156.575
72	72	156.625	156.625
73	73	156.675	156.675
74	74	156.725	156.725
75	75	Guard	Guard
76	76	Guard	Guard
77	77	156.875	156.875
78		156.925	161.525
	78A	156.925	156.925
79		156.975	161.575
	79A	156.975	156.975
80		157.025	161.625
	80A	157.025	157.025
81		157.075	161.675
	81A	157.075	157.075
82		157.125	161.725
	82A	157.125	157.125

Channel number		Frequency (MHz)	
INT	USA	Trans-cieve	Receive
83		157.175	161.775
	83A	157.175	157.175
84	84	157.225	161.825
84		157.225	157.225
85	85	157.275	161.875
85		157.275	157.275
86	86	157.325	161.925
	86A	157.325	157.325
87	87	157.375	161.975
87		157.375	157.375
88	88	157.425	162.025
	88A	157.425	157.425
WX channel (U.S.A. only)	Frequency (MHz)		
	Transmit	Receive	
01	RX only	162.550	
02	RX only	162.400	
03	RX only	162.475	
04	RX only	162.425	
05	RX only	162.450	
06	RX only	162.500	
07	RX only	162.525	
08	RX only	161.650	
09	RX only	161.775	
10	RX only	163.275	

*1 Low power only *2 Transmit is inhibited *3 Momentary high power.

NOTE: U.S.A. version includes all "A" channels in the INT channel group.

12 SPECIFICATIONS

GENERAL

- Frequency coverage : Transmit 156–157.5 MHz
Receive 156–163 MHz
- Mode : 16K0G3E
- Number of memory channels : 25 (24 regular memories and 1 call channel)
- Power supply requirement : 13.8 V DC \pm 15%
- Current drain (at 13.8 V DC) : Transmit,
high power 6.0 A
low power 1.5 A
Receive,
standby 350 mA
max. audio output 1.2 A
- Frequency stability : \pm 0.0005%
- Usable temp. range : -20°C to $+60^{\circ}\text{C}$;
 -4°F to $+140^{\circ}\text{F}$
- Dimensions (W) \times (H) \times (D): 140 \times 55 \times 155 mm
5 1/2 \times 2 5/32 \times 6 3/32 in
(projections not included)
- Weight : 1.0 kg/2.2 lb

TRANSMITTER

- Output power : High 25 W Low 1 W
- Modulation system : Variable reactance phase modulation
- Max. frequency deviation : \pm 5.0 kHz
- Spurious emissions : Less than -70 dB (U.S.A.)
Less than -80 dB (U.K.)
- Microphone impedance : 600 Ω

RECEIVER

- Receive system : Double-conversion superheterodyne
- Intermediate frequencies : 1st 21.8 MHz 2nd 455 kHz
- Sensitivity : 0.32 μV for 12 dB SINAD
- Squelch sensitivity : 0.18 μV at threshold
- Adjacent channel selectivity : More than 70 dB
- Spurious response rejection : More than 70 dB
- Intermodulation rejection : More than 70 dB
- Audio output power : 3.5 W with a 4 Ω load
- Audio output impedance : 4 Ω

All stated specifications are subject to change without notice or obligation.



HS-57 HANDSET KIT
Provides listening privacy.

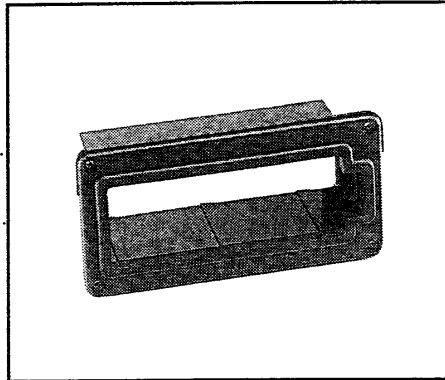

MB-28 FLUSH MOUNT
For mounting the IC-M58 to a panel. Available in black or white.

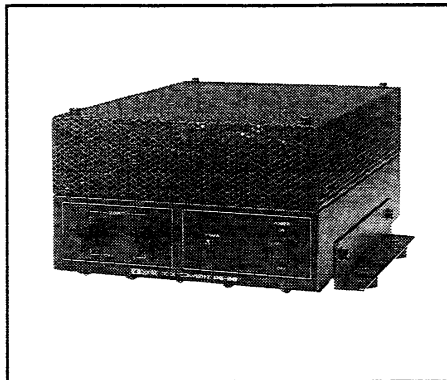

**PS-66
DC-DC CONVERTER**
Input voltage: 19 to 32 V DC
Output voltage: 13.6 V DC

◇ INTERNAL UNITS

• UT-79 VOICE SCRAMBLER UNIT

Provides private communications. Analog-type voice scrambling unit with 128 scramble codes available.

• UX-114 DSC UNIT

When the UX-114 is installed, the transceiver conforms to U.S. Coast Guard proposal SC-101 for marine digital communications.

◇ EXTERNAL SPEAKERS

• SP-5 EXTERNAL SPEAKER

A large external speaker for superior audio output.

• SP-10 EXTERNAL SPEAKER

A compact external speaker. Features easy installation.

Count on us!

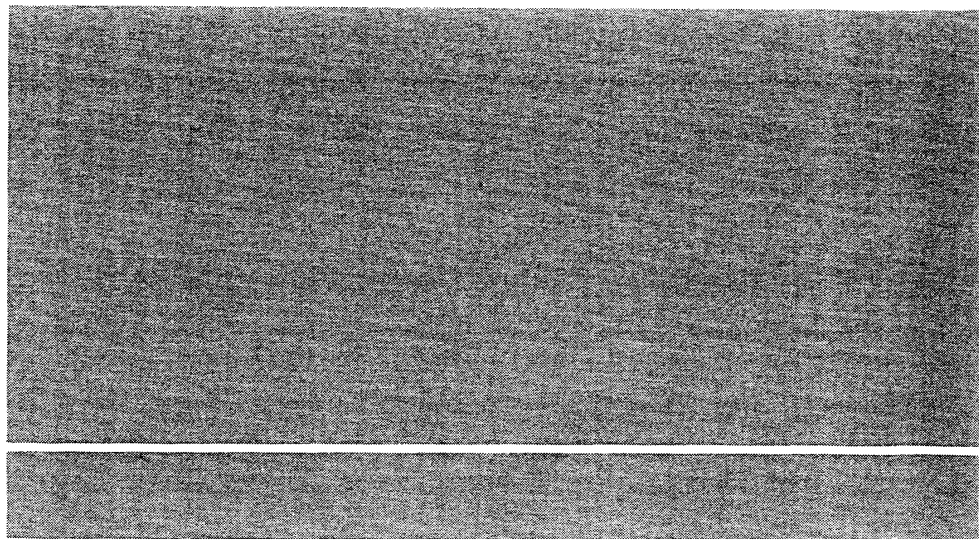

A-5316S-1EX
Printed in Japan
Copyright © 1994 by Icom Inc.



Icom Inc.
6-9-16, Kamihigashi, Hirano-ku, Osaka 547, Japan