



## INSTRUCTION MANUAL

VHF MARINE TRANSCEIVER

# IC-M504A



Icom Inc.

---

## FOREWORD

---

Thank you for purchasing this Icom product. The IC-M504A VHF MARINE TRANSCEIVER is designed and built with Icom's state of the art technology and craftsmanship. With proper care, this product should provide you with years of trouble-free operation.

We appreciate you making the IC-M504A your radio of choice, and hope you agree with Icom's philosophy of "technology first." Many hours of research and development went into the design of your IC-M504A.

### ◇ **FEATURES**

- *Simple operation with large keys*
- *Easy to hear speaker*
- *Built-in DSC meets ITU Class D requirement*
- *Rugged waterproof construction*
- *Optional COMMANDMICII™ (HM-157) and COMMANDMICIII™ (HM-162) are available*
- *Easy to make individual DSC calls using Icom's MA-500TR Class B AIS Transponder*

---

## IMPORTANT

---

**READ ALL INSTRUCTIONS** carefully and completely before using the transceiver.

**SAVE THIS INSTRUCTION MANUAL** — This instruction manual contains important operating instructions for the IC-M504A.

---

## EXPLICIT DEFINITIONS

---

WORD	DEFINITION
⚠ <b>WARNING!</b>	Personal injury, fire hazard or electric shock may occur.
<b>CAUTION</b>	Equipment damage may occur.
<b>NOTE</b>	If disregarded, inconvenience only. No risk of personal injury, fire or electric shock.

**CLEAN THE TRANSCEIVER AND MICROPHONE THOROUGHLY WITH FRESH WATER** after exposure to water including salt, otherwise, the keys and switch may become inoperable due to salt crystallization.

---

## IN CASE OF EMERGENCY

---

If your vessel requires assistance, contact other vessels and the Coast Guard by sending a Distress call on Channel 16.

### **USING CHANNEL 16**

#### **DISTRESS CALL PROCEDURE**

1. "MAYDAY MAYDAY MAYDAY"
2. "THIS IS ....." (name of vessel).
3. Say your call sign or other description of the vessel (AND 9 digit DSC ID if you have one).
4. "LOCATED AT ....." (your position).
5. State the nature of the distress and assistance required.
6. Give any other information which might facilitate the rescue.

Or, transmit your Distress call using digital selective calling on Channel 70.

### **USING DIGITAL SELECTIVE CALLING (Ch 70)**

#### **DISTRESS CALL PROCEDURE**

1. While lifting up the key cover, hold down **[DISTRESS]** for 5 seconds until you hear 5 short beeps and then one long beep.
2. Wait for an acknowledgment on Channel 70 from a coast station.
  - After the acknowledgement is received, Channel 16 is automatically selected.
3. Hold down **[PTT]**, then transmit the appropriate information as listed above.

---

## NOTE

---

**A WARNING STICKER** is supplied with the transceiver. To comply with FCC regulations, this sticker must be affixed in such a location as to be readily seen from the operating controls of the radio as in the diagram below. Make sure the chosen location is clean and dry before applying the sticker.

### EXAMPLE

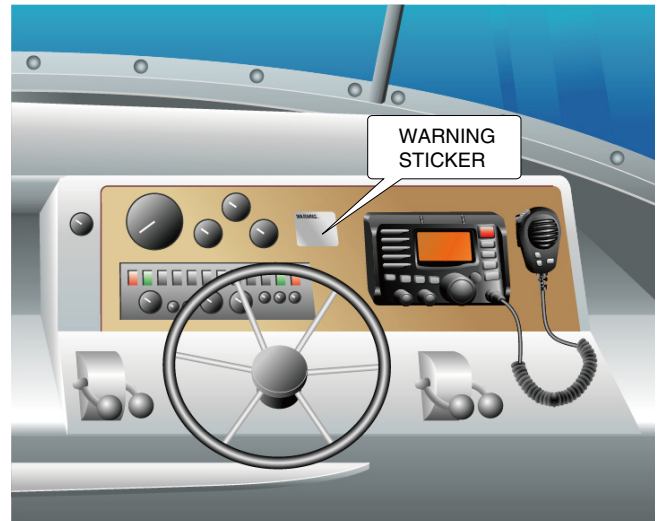

---

## RADIO OPERATOR WARNING

---



Icom requires the radio operator to meet the FCC Requirements for Radio Frequency Exposure. An omnidirectional antenna with gain not greater than 9 dBi must be mounted a minimum of 5 meters (measured from the lowest point of the antenna) vertically above the main deck and all possible personnel. This is the minimum safe separation distance estimated to meet all RF exposure compliance requirements. This 5 meter distance is based on the FCC Safe Maximum Permissible Exposure (MPE) distance of 3 meters added to the height of an adult (2 meters) and is appropriate for all vessels.

For watercraft without suitable structures, the antenna must be mounted so as to maintain a minimum of 1 meter vertically between the antenna, (measured from the lowest point of the antenna), to the heads of all persons AND all persons must stay outside of the 3 meter MPE radius.

Do not transmit with radio and antenna when persons are within the MPE radius of the antenna, unless such persons (such as driver or radio operator) are shielded from antenna field by a grounded metallic barrier. The MPE Radius is the minimum distance from the antenna axis that person should maintain in order to avoid RF exposure higher than the allowable MPE level set by FCC.

**FAILURE TO OBSERVE THESE LIMITS MAY ALLOW THOSE WITHIN THE MPE RADIUS TO EXPERIENCE RF RADIATION ABSORPTION WHICH EXCEEDS THE FCC MAXIMUM PERMISSIBLE EXPOSURE (MPE) LIMIT. IT IS THE RESPONSIBILITY OF THE RADIO OPERATOR TO ENSURE THAT THE MAXIMUM PERMISSIBLE EXPOSURE LIMITS ARE OBSERVED AT ALL TIMES DURING RADIO TRANSMISSION. THE RADIO OPERATOR IS TO ENSURE THAT NO BYSTANDERS COME WITHIN THE RADIUS OF THE MAXIMUM PERMISSIBLE EXPOSURE LIMITS.**

### **Determining MPE Radius**

**THE MAXIMUM PERMISSIBLE EXPOSURE (MPE) RADIUS HAS BEEN ESTIMATED TO BE A RADIUS OF ABOUT 3M PER OET BULLETIN 65 OF THE FCC. THIS ESTIMATE IS MADE ASSUMING THE MAXIMUM POWER OF THE RADIO AND ANTENNAS WITH A MAXIMUM GAIN OF 9dBi ARE USED FOR A SHIP MOUNTED SYSTEM.**

# TABLE OF CONTENTS

FOREWORD .....	i	■ Position and time indication .....	19
IMPORTANT .....	i	■ GPS information display .....	19
EXPLICIT DEFINITIONS .....	i	■ Distress call .....	20
IN CASE OF EMERGENCY .....	ii	■ Transmitting DSC calls .....	23
NOTE .....	ii	■ Receiving DSC calls .....	35
RADIO OPERATOR WARNING .....	iii	■ Received messages .....	43
TABLE OF CONTENTS .....	iv	■ DSC Set up menu .....	44
PRECAUTIONS .....	v	<b>7 OTHER FUNCTIONS .....</b>	<b>48–52</b>
<b>1 OPERATING RULES .....</b>	<b>1</b>	■ Intercom operation .....	48
<b>2 PANEL DESCRIPTION .....</b>	<b>2–5</b>	■ RX Speaker function .....	49
■ Front panel .....	2	■ Hailer operation .....	50
■ Function display .....	4	■ Automatic Foghorn function .....	51
■ Speaker Microphone .....	5	<b>8 SET MODE .....</b>	<b>53–55</b>
<b>3 BASIC OPERATION .....</b>	<b>6–11</b>	■ Set mode programming .....	53
■ Channel selection .....	6	■ Set mode items .....	53
■ Receiving and transmitting .....	8	<b>9 CONNECTIONS AND MAINTENANCE .....</b>	<b>56–66</b>
■ Call channel programming .....	9	■ Connections .....	56
■ Channel comments .....	9	■ Antenna .....	58
■ Microphone Lock function .....	10	■ Fuse replacement .....	58
■ Display backlight .....	10	■ Cleaning .....	58
■ Optional voice scrambler operation .....	11	■ Supplied accessories .....	58
<b>4 SCAN OPERATION .....</b>	<b>12–13</b>	■ Mounting the transceiver .....	59
■ Scan types .....	12	■ MB-75 installation .....	60
■ Setting TAG channels .....	13	■ UT-112/UT-98 installation .....	61
■ Starting a scan .....	13	■ Microphone installation .....	62
<b>5 DUALWATCH/TRI-WATCH .....</b>	<b>14</b>	<b>10 TROUBLESHOOTING .....</b>	<b>67</b>
■ Description .....	14	<b>11 SPECIFICATIONS AND OPTIONS .....</b>	<b>68–69</b>
■ Operation .....	14	■ Specifications .....	68
<b>6 DSC OPERATION .....</b>	<b>15–47</b>	■ Options .....	69
■ MMSI code programming .....	15	<b>12 CHANNEL LIST .....</b>	<b>70</b>
■ DSC address ID .....	16	<b>13 TEMPLATE .....</b>	<b>71</b>
■ Position and time programming .....	18	<b>14 FCC INFORMATION .....</b>	<b>73</b>



---

## PRECAUTIONS

---

⚠ **WARNING! NEVER** connect the transceiver to an AC outlet. This may pose a fire hazard or result in an electric shock.

⚠ **WARNING! NEVER** connect the transceiver to a power source of more than 16 V DC or use reverse polarity. This will ruin the transceiver.

⚠ **WARNING! NEVER** cut the DC power cable between the DC plug at the back of the transceiver and fuse holder. If an incorrect connection is made after cutting, the transceiver may be damaged.

**CAUTION: NEVER** place the transceiver where normal operation of the vessel may be hindered or where it could cause bodily injury.

**CAUTION:** Changes or modifications to this device, not expressly approved by Icom Inc., could void your authority to operate this device under FCC regulations.

**KEEP** the transceiver and microphone at least 1 m (3.3 ft) away from the vessel's magnetic navigation compass.

**DO NOT** use or place the transceiver in areas with temperatures below  $-20^{\circ}\text{C}$  ( $-4^{\circ}\text{F}$ ) or above  $+60^{\circ}\text{C}$  ( $+140^{\circ}\text{F}$ ) or, in areas subject to direct sunlight, such as the dashboard.

**DO NOT** use harsh solvents such as benzine or alcohol to clean the transceiver, as they will damage the transceiver's surfaces. If the transceiver becomes dusty or dirty, wipe it clean with a soft, dry cloth.

**BE CAREFUL!** The transceiver rear panel will become hot when operating continuously for long periods of time.

Place the transceiver in a secure place to avoid inadvertent use by children.

**BE CAREFUL!** The transceiver and the optional HM-157 COMMANDMICII™/HM-162 COMMANDMICIII™ meet IPX8 requirements for waterproof protection. However, once the transceiver has been dropped, waterproof protection cannot be guaranteed because of possible damage to the transceiver's case or the waterproof seal.

Icom, Icom Inc. and the Icom logo are registered trademarks of Icom Incorporated (Japan) in Japan, the United States, the United Kingdom, Germany, France, Spain, Russia and/or other countries.

COMMANDMIC is a registered trademark of Icom Incorporated (Japan) in Japan and the United States.

## ◇ Priorities

- Read all rules and regulations pertaining to call priorities, and keep an up-to-date copy handy. Safety and distress calls take priority over all others.
- You must monitor Channel 16 when you are not operating on another channel.
- False or fraudulent distress calls are prohibited under law.

## ◇ Privacy

- Information overheard, but not intended for you, cannot lawfully be used in any way.
- Indecent or profane language is prohibited.

## ◇ Radio licenses

### (1) SHIP STATION LICENSE

You may require a current radio station license before using the transceiver. It is unlawful to operate a ship station which is not licensed, but required to be.

If required, contact your dealer or the appropriate government agency for a Ship-Radiotelephone license application. This government-issued license states the call sign which is your craft's identification for radio purposes.

### (2) OPERATOR'S LICENSE

A Restricted Radiotelephone Operator Permit is the license most often held by small vessel radio operators when a radio is not required for safety purposes.

If required, the Restricted Radiotelephone Operator Permit must be posted or kept with the operator. If required, only a licensed radio operator may operate a transceiver.

However, non-licensed individuals may talk over a transceiver if a licensed operator starts, supervises, ends the call and makes the necessary log entries.

A current copy of the applicable government rules and regulations is only required to be on hand for vessels in which a radio telephone is compulsory. However, even if you are not required to have these on hand it is your responsibility to be thoroughly acquainted with all pertinent rules and regulations.

**NOTE:** Even though the IC-M504A is capable of operation on VHF marine channels 3, 21, 23, 61, 64, 81, 82 and 83, according to FCC regulations these simplex channels cannot be lawfully used by the general population in USA waters.

## Front panel

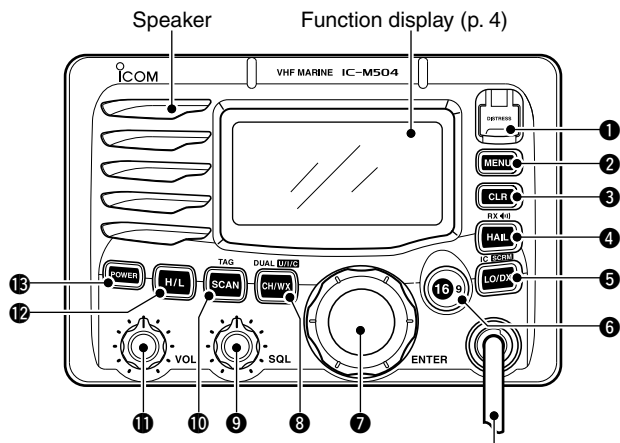

The microphone may be connected here, or the microphone and its connection kit for the rear panel are separately included, depending on the transceiver version.  
 • See pages 58 and 62 for details.

- 1 DISTRESS KEY [DISTRESS]** (pp. 20, 22)  
Hold down for 5 seconds to transmit a Distress call.
- 2 DSC MENU KEY [MENU]**  
Push to toggle the DSC menu appear or disappear. (p. 15)
- 3 CLEAR KEY [CLR]** (pp. 9, 55)  
Push to cancel the entered function, exit Set mode.

- 4 HAIL/RX SPEAKER KEY [HAIL•RX ◀▶]**
  - ➔ Push to turn the hailer mode ON or OFF. (p. 50)
  - ➔ Hold down for 1 second to turn the RX Speaker mode ON or OFF. (p. 49)
  - ➔ While holding down [H/L], push to turn the Automatic Foghorn function ON. (p. 51)
- 5 ATTENUATOR/INTERCOM KEY [LO/DX•IC•SCRM]**
  - ➔ Push to turn the Attenuator function ON or OFF. (p. 8)
  - “LOC” appears when the Attenuator function is turned ON.
  - ➔ Hold down for 1 second to activate an optional Intercom function. (p. 48)
  - ➔ Hold down to call the optional Command microphone while in Intercom mode. (p. 48)
  - ➔ While holding down [H/L], push to turn the Voice Scrambler function ON or OFF. (p. 11)
- 6 CHANNEL 16/CALL CHANNEL KEY [16•9]**
  - ➔ Push to select Channel 16. (p. 6)
  - ➔ Hold down for 1 second to select Call channel. (p. 6)
  - “CALL” appears when Call channel is selected.
  - ➔ Hold down for 3 seconds to enter Call channel programming mode when Call channel is selected. (p. 9)
  - ➔ While holding down [H/L], push to enter the channel comment programming mode. (p. 9)
  - ➔ Push to move the cursor forward while in the channel comment programming mode. (p. 9)
  - ➔ While turning power ON, push to enter Set mode. (p. 53)



**7 CHANNEL SELECTOR [DIAL•ENTER]**

- Rotate to select the operating channels, Set mode settings, etc. (pp. 6–8, 53)
- While holding down [H/L], rotate to adjust the brightness of the LCD and key backlight. (p. 10)
- Push to enter the input channel comment, selected item, etc. (pp. 9, 53)
- Rotate to check TAG channels, changes scanning direction or resumes the scan manually during scan. (p. 13)
- While holding down [HAIL•RX ◀▶], rotate to adjust the audio level in RX Speaker mode. (p. 49)
- Hold down for 1 second to display the GPS information when a GPS receiver is connected. (p. 19)

**8 CHANNEL/WEATHER CHANNEL KEY [CH/WX•DUAL•U//C]**

- Selects and toggles the regular channel and Weather channel when pushed momentarily. (p. 7)
- Hold down for 1 second to start Dualwatch or Tri-watch. (p. 14)
- Push to stop Dualwatch or Tri-watch when either is activated. (p. 14)
- Push to move the cursor backward while in the channel comment programming mode. (p. 9)
- While holding down [H/L], push to select one of three channel groups in sequence. (p. 7)
  - U.S.A., International and Canadian channels are available.

**9 SQUELCH CONTROL [SQL]**

Rotate to set the squelch threshold level. (p. 8)

**10 SCAN/TAG KEY [SCAN•TAG] (p. 13)**

- Push to start and stop Normal or Priority scan.
- Hold down for 1 second to set or clear the displayed channel as a TAG (scanned) channel.
- While holding down [H/L], hold down for 3 seconds to clear or set all TAG channels in the selected channel group.

**11 VOLUME CONTROL [VOL] (p. 8)**

Rotate to adjust the audio level.

**12 TRANSMIT POWER KEY [H/L]**

- Push to toggle the power high or low. (p. 8)
  - Some channels are set to low power only.
- While pushing this key, some keys perform secondary functions.

**13 POWER KEY [POWER] (p. 8)**

- Push to turn power ON.
- Hold down for 1 second to turn power OFF.

## 2 PANEL DESCRIPTION

### ■ Function display

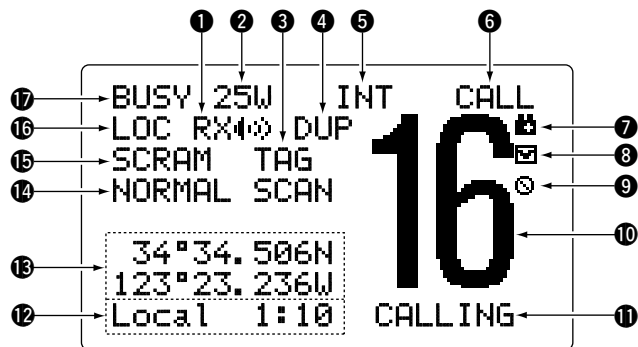

- 1 RX SPEAKER ICON** (p. 49)  
Appears during the RX Speaker mode.
- 2 POWER ICON** (p. 8)
  - “25W” appears when high power is selected.
  - “1W” appears when low power is selected.
- 3 TAG CHANNEL ICON** (p. 13)  
Appears when a TAG channel is selected.
- 4 DUPLEX ICON** (p. 7)  
Appears when a duplex channel is selected.
- 5 CHANNEL GROUP ICON** (p. 7)  
Indicates whether an U.S.A. “USA,” International “INT,” Canadian “CAN” or weather “WX” channel is in use.
- 6 CALL CHANNEL ICON** (pp. 6, 9)  
Appears when the call channel is selected.

- 7 LOW BATTERY ICON**  
Blinks when the battery voltage drops to approximately 10 V DC or below.
- 8 MAIL ICON** (pp. 35, 43)  
Blinks when there is an unread message.
- 9 AUTO SW ICON** (pp. 46, 47)  
Blinks when both the Auto Switch function and Auto Tune timer are turned OFF.
- 10 CHANNEL NUMBER READOUT**  
Indicates the selected operating channel number.
- 11 CHANNEL COMMENT INDICATOR**  
Channel comment appears if programmed. (p. 9)
  - In the Hailer mode, “WAIT” appears while holding down [PTT] of the optional Command microphone.
- 12 TIME ZONE INDICATOR**
  - Shows the current time data when a GPS receiver is connected, or the time data is manually programmed.
    - When the GPS current time data is invalid, “??” may blink every 2 seconds instead of current time data. After 23.5 hours have passed, “No Time” will appear.
    - “??” may blink every 2 seconds instead of current time data, after 4 hours have passed from the time when the time data was manually programmed. The manually programmed time data is held for only 23.5 hours, and after that, “No Time” will appear.
  - “Local” appears when the offset time data is set. (p. 44)
  - “No Time” appears when no GPS receiver is connected and no time data is manually input.

**13 POSITION INDICATOR**

- Shows the current position data when a GPS receiver is connected, or the time data is manually programmed.
  - When the GPS position data is invalid, “??” may blink every 2 seconds instead of position data. The last position data is held for only 23.5 hours, and after that, “No Position” will appear.
  - “??” may blink every 2 seconds instead of position data, after 4 hours have passed from the time when the position data is manually programmed. The manually programmed position data is held for only 23.5 hours, and after that, “No Position” will appear.
- “No Position” appears when no GPS receiver is connected and no position data is input manually.

**14 SCAN INDICATOR**

- “PRI-SCAN 16” appears during Priority scan; “NORMAL SCAN” appears during Normal scan. (p. 13)
- “DUAL 16” appears during Dualwatch; “TRI 16” appears during Tri-watch. (p. 14)

**15 SCRAMBLER ICON** (p. 11)

Appears when the voice scrambler function is turned ON. (only when the optional scrambler unit is installed.)

**16 LOCAL ICON** (p. 8)

Appears when the Attenuator function is turned ON.

**17 BUSY/TRANSMIT ICON** (p. 8)

- “BUSY” appears when receiving a signal or when the squelch opens.
- “TX” appears while transmitting.

**Speaker Microphone**

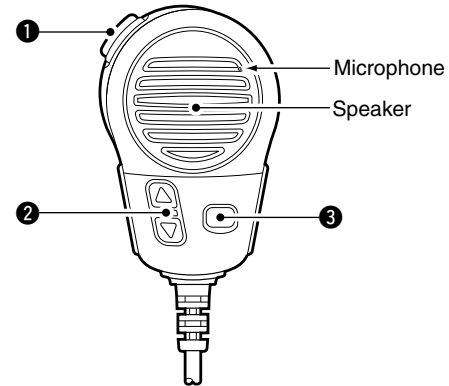

**1 PTT SWITCH [PTT]**

Hold down to transmit; release to receive. (p. 8)

**2 CHANNEL UP/DOWN KEYS [▲]/[▼]**

- Push either key to change the operating channel, Set mode settings, etc. (pp. 6, 7, 53)
- Checks TAG channels, changes scanning direction or manually resumes a scan. (p. 13)

**3 TRANSMIT POWER KEY [HI/LO]**

- Push to toggle the power high and low. (p. 8)
  - Some channels are set to only low power.
- While holding down [HI/LO], turn ON the to turn the Microphone Lock function ON or OFF. (p. 10)

## ■ Channel selection

### ◇ Channel 16

Channel 16 is the distress and safety channel. It is used for establishing initial contact with a station and for emergency communications. Channel 16 is monitored during both Du-alwatch and Tri-watch. While standing by, you must monitor Channel 16.

- Push **[16•9]** momentarily to select Channel 16.
- Push **[CH/WX•DUAL•U//C]** to return to the screen before you selected Channel 16, or rotate **[DIAL]** to select an operating channel.

Push 

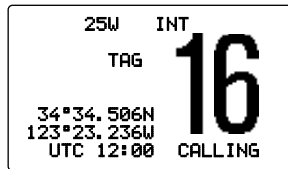

### ◇ Channel 9 (Call channel)

Each regular channel group has a separate leisure-use Call channel. The Call channel is monitored during Tri-watch. The Call channels can be programmed and are used to store your most often used channel in each channel group for quick recall. (p. 9)

- Hold down **[16•9]** for 1 second to select the Call channel of the selected channel group.
  - “CALL” and Call channel number appear.
  - Each channel group may have an independent call channel after programming a Call channel. (p. 9)
- Push **[CH/WX•DUAL•U//C]** to return to the screen before you selected Call channel, or rotate **[DIAL]** to select a channel.

Hold down   
for 1 second

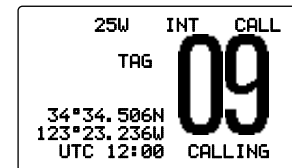

◇ **U.S.A., international and Canadian channels**

The IC-M504A is pre-programmed with 59 U.S.A., 59 international and 63 Canadian channels. These channel groups may be specified for the operating area.

- ① Push **[CH/WX•DUAL•U//C]** to select a regular channel.
  - If a weather channel appears, push **[CH/WX•DUAL•U//C]** again.
- ② While holding down **[H/L]**, push **[CH/WX•DUAL•U//C]** to change the channel group, if necessary.
  - U.S.A., International and Canadian channel groups can be sequentially selected.
- ③ Rotate **[DIAL]** to select a channel.
  - “DUP” appears for duplex channels.
  - When a simplex channel is selected, “A” appears.
  - Pushing the keypad keys, or **[▲]/[▼]** on the microphone, also selects a channel.

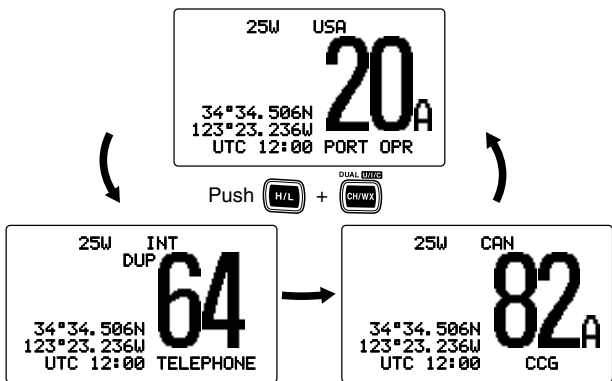

◇ **Weather channels**

The IC-M504A has 10 weather channels. These are used for monitoring broadcasts from NOAA (National Oceanographic and Atmospheric Administration.)

The transceiver can automatically detect a weather alert tone on the selected weather channel while receiving on another channel, during standby on a regular channel or while scanning. (p. 54)

- ① Push **[CH/WX•DUAL•U//C]** once or twice to select a weather channel.
  - “WX” appears when a weather channel is selected.
  - “WX ALERT” appears when the Weather Alert function is in turned ON. (p. 54)
- ② Rotate **[DIAL]** to select a channel.
  - Pushing the keypad keys, or **[▲]/[▼]** on the microphone, also selects a channel.

Push **[CH/WX]** once or twice

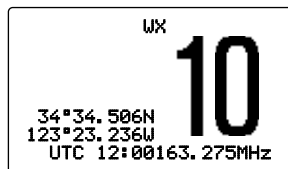

When weather alert is OFF.

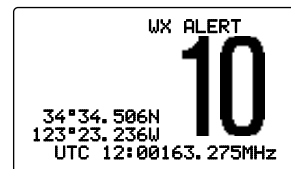

When weather alert is ON.

### 3 BASIC OPERATION

## ■ Receiving and transmitting

/// **CAUTION:** Transmitting without an antenna will damage the transceiver.

- ① Push **[POWER]** to turn ON the power.
- ② Set the audio and squelch levels.
  - ➔ Rotate **[SQL]** fully counterclockwise first.
  - ➔ Rotate **[VOL]** to adjust the audio output level.
  - ➔ Rotate **[SQL]** clockwise until the noise disappears.
- ③ While holding down **[H/L]**, push **[CH/WX•DUAL•U/I/C]** one or more times to change the channel group. (p. 7)
- ④ Rotate **[DIAL]** to select a channel. (pp. 6, 7)
  - Pushing the keypad keys, or **[▲]/[▼]** on the microphone, also selects a channel.
  - When receiving a signal, “BUSY” appears and audio is emitted from the speaker.
  - Further adjustment of **[VOL]** may be necessary.
- ⑤ Push **[LO/DX•IC•SCRM]** to turn the receive Attenuator function ON or OFF, if necessary.
  - “LOC” appears when the receive Attenuator function is ON.
- ⑥ Push **[H/L]** to select the output power if necessary.
  - “25W” or “1W” appears when high or low power is selected, respectively.
  - Choose low power for short range communications, choose high power for longer distance communications.
  - Some channels are for low power only.
- ⑦ Hold down **[PTT]** to transmit, then speak into the microphone at your normal voice level.
  - “TX” appears.
  - Channel 70 cannot be used for transmission other than DSC.
- ⑧ Release **[PTT]** to receive.

/// Simplex channels, 3, 21, 23, 61, 64, 81, 82 and 83 **CANNOT** be lawfully used by the general public in U.S.A. waters.

/// **IMPORTANT:** To maximize the readability of your transmitted signal, pause a few seconds after pushing **[PTT]**, hold the microphone 2 to 4 inches (5 to 10 cm) from your mouth and speak at a normal voice level.

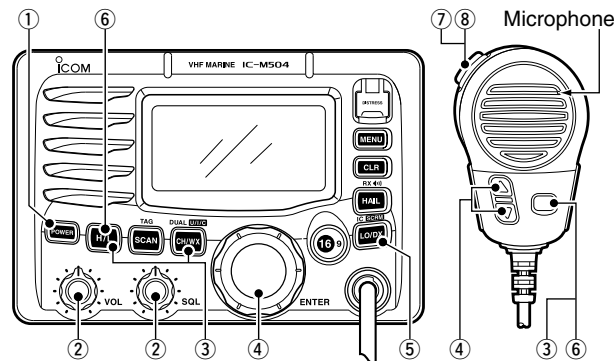

### ✓ NOTE for TOT (Time-out Timer) function

The TOT function inhibits continuous transmission over a pre-set time period after the transmission starts.

10 seconds before the TOT function activates, a beep sounds to indicate the transmission will be shut down and “TOT” appears on the channel comment indicator. Transmission is not possible for 10 seconds after this transmission shut down.

## ■ Call channel programming

The Call channel is used to select Channel 9 (default); however, you can program the Call channel with your most often-used channels in each channel group for quick recall.

- ① While holding down **[H/L]**, push **[CH/WX•DUAL•U//C]** several times to select the desired channel group (U.S.A., International or Canada) to be programmed.
- ② Hold down **[16•9]** for 1 second to select the Call channel of the selected channel group.
  - “CALL” and Call channel number appear.

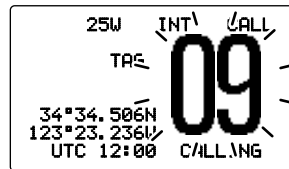

- ③ Hold down **[16•9]** again for 3 seconds (until a long beep changes to 2 short beeps) to enter the Call channel programming mode.
  - Channel number starts blinking.
- ④ Rotate **[DIAL]** to select the desired channel.
- ⑤ Push **[16•9]** to program the displayed channel as the Call channel.
  - Push **[CLR]** to cancel.
  - The channel number stops blinking.

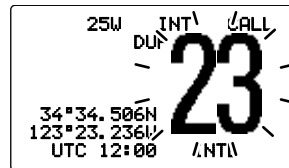

## ■ Channel comments

Each channel can be labeled with a unique alphanumeric ID of up to 10 characters.

Capital letters, small letters, 0 to 9, some symbols (— . /) and space can be used.

- ① Select the desired channel.
  - Cancel Dualwatch, Tri-watch or Scan first.
- ② While holding down **[H/L]**, push **[16•9]** to edit the channel comment.
  - A cursor and the first character start blinking alternately.
- ③ Rotate **[DIAL]** to select the desired character.
  - Push **[16•9]** to move the cursor forward, or **[CH/WX•DUAL•U//C]** to move it backward.
- ④ Repeat step ③ to input all characters.
  - Push **[CLR]** to cancel and exit the mode.
- ⑤ Push **[DIAL•ENTER]** to input and set the comment.
  - The cursor and the character stop blinking.
- ⑥ Repeat steps ① to ⑤ to program other channel comments, if desired.

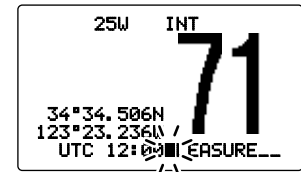

### 3 BASIC OPERATION

#### ■ Microphone Lock function

The Microphone Lock function electrically locks [▲]/[▼] and [HI/LO] keys on the supplied microphone. This prevents accidental channel changes and function access.

- ➔ While holding down [HI/LO] on the microphone, turn ON the power to turn the Microphone Lock function ON or OFF.

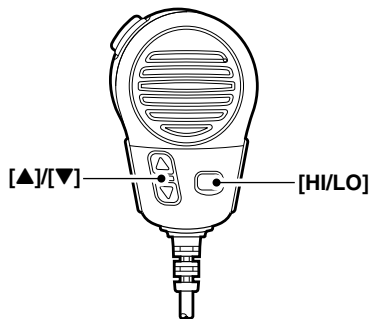

#### ■ Display backlight

The function display and keys can be backlit for better visibility under low light conditions.

- ➔ While holding down [H/L], rotate [DIAL] to adjust the brightness of the LCD and key backlight. Then, push [DIAL•ENTER].
  - The backlight is adjustable in 7 levels and OFF.

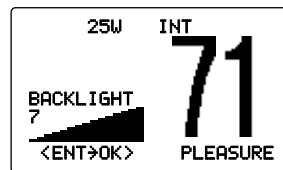



## ■ Optional voice scrambler operation

### ◇ Activating the scrambler

The optional voice scrambler provides private communications. In order to receive or send scrambled transmissions you must first activate the scrambler function. To activate the function, an optional scrambler unit is necessary. See page 61 for setting the scrambler unit. Ask your dealer for details.

/// The scrambler function automatically turns OFF when Channel 16 or 70 is selected.

- ① Rotate **[DIAL]** to select the desired channel other than Channel 16 and 70.
- ② While holding down **[H/L]**, push **[LO/DX•IC•SCRM]** to turn ON the optional Voice Scrambler function.
  - “SCRAM” appears.
- ③ To turn OFF the function, repeat step ②.
  - “SCRAM” disappears.

### ◇ Programming scrambler codes

There are 32 codes (1 to 32) or 128 codes (0 to 127)\* available for programming when an optional scrambler unit is installed. In order to understand one another, all transceivers in your group must have the same scramble code. This function may not be available depending on the dealer setting.

\*Depends on the installed scrambler unit.

- ① Turn the power OFF, then while holding down **[16•9]**, push **[POWER]** to enter the Set mode.
- ② After the display appears, release **[16•9]**.
- ③ Rotate **[DIAL]** to select the “Scrambler Code,” the push **[DIAL•ENTER]**.
- ④ Rotate **[DIAL]** to select the desired scrambler code.
- ⑤ Push **[DIAL•ENTER]** to set and exit the scrambler code item.
- ⑥ Push **[CLR]**, or rotate **[DIAL]** to select “Exit,” then push **[DIAL•ENTER]** to exit Set mode.

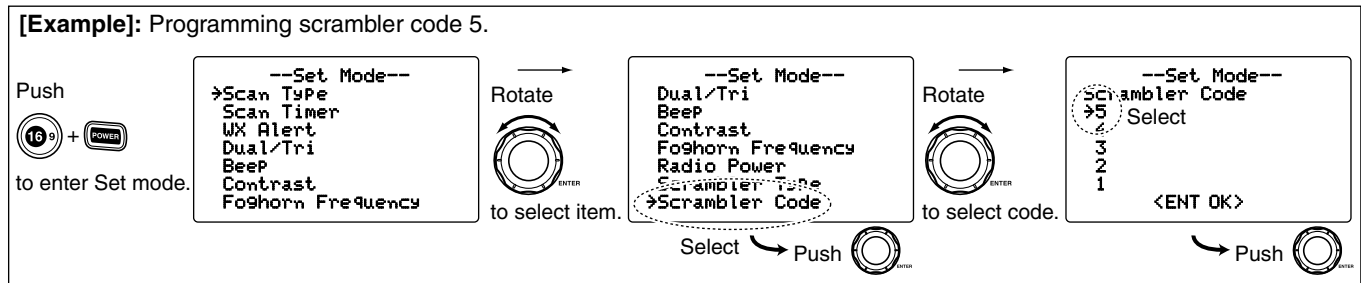

## ■ Scan types

Scanning is an efficient way to locate signals quickly over a wide frequency range. The transceiver has Priority scan and Normal scan.

When the Weather Alert function is turned ON, the previously selected (last used) weather channel is also checked while scanning. (p. 54)

### PRIORITY SCAN

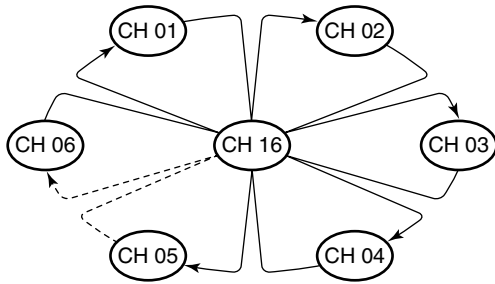

Priority scan searches through all TAG channels in sequence while monitoring Channel 16. When a signal is detected on Channel 16, scan pauses until the signal disappears; when a signal is detected on a channel other than Channel 16, scan becomes Dualwatch until the signal disappears.

Set the TAG channels (scanned channel) before scanning. Clear the TAG channels which inconveniently stop scanning, such as those for digital communication use. (Refer to the right page for details.)

/// Choose Priority or Normal scan in Set mode. (p. 53)

### NORMAL SCAN

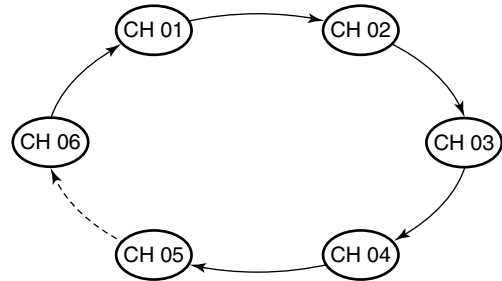

Normal scan, like Priority scan, searches through all TAG channels in sequence. However, unlike Priority scan, Channel 16 is not checked unless Channel 16 is set as a TAG channel.

## ■ Setting TAG channels

For more efficient scanning, add the desired channels as TAG channels or clear the TAG for unwanted channels.

Channels that are not tagged will be skipped during scanning. TAG channels can be assigned to each channel group (U.S.A., International and Canada)) independently.

- ① While holding down [H/L], push [CH/WX•DUAL•U//C] one or more times to select the desired channel group.
- ② Select the desired channel to be set as a TAG channel.
- ③ Hold down [SCAN•TAG] for 1 second to set the displayed channel as a TAG channel.
  - “TAG” appears on the display.
- ④ To cancel the TAG channel setting, repeat step ③.
  - “TAG” disappears.

### ✓ Clearing (or setting) all tagged channels

While holding down [H/L], hold down [SCAN•TAG] for 3 seconds (until a long beep changes to 2 short beeps) to clear all TAG channels setting in the selected channel group.

- Repeat above procedure to set all channels as TAG channels.

## ■ Starting a scan

Set scan type (Priority or Normal scan) and scan resume timer first using Set mode. (p. 53)

- ① While holding down [H/L], push [CH/WX•DUAL•U//C] one or more times to select the desired channel group, if desired.
- ② Set TAG channels as described to the left.
- ③ Make sure the squelch is closed to start a scan.
- ④ Push [SCAN•TAG] to start Priority or Normal scan.
  - “PRI-SCAN 16” appears during Priority scan; “NORMAL SCAN” appears during Normal scan.
  - When a signal is detected, scan pauses until the signal disappears or resumes after pausing 5 seconds depending on the Set mode setting. (Channel 16 is still monitored during Priority scan.)
  - Rotate [DIAL], or push [▲]/[▼] on the microphone, to check the scanning TAG channels, to change the scanning direction or resume the scan manually.
  - A beep tone sounds and “16” blinks when a signal is received on Channel 16 during Priority scan.
- ⑤ To stop the scan, push [CLR] or repeat step ④.

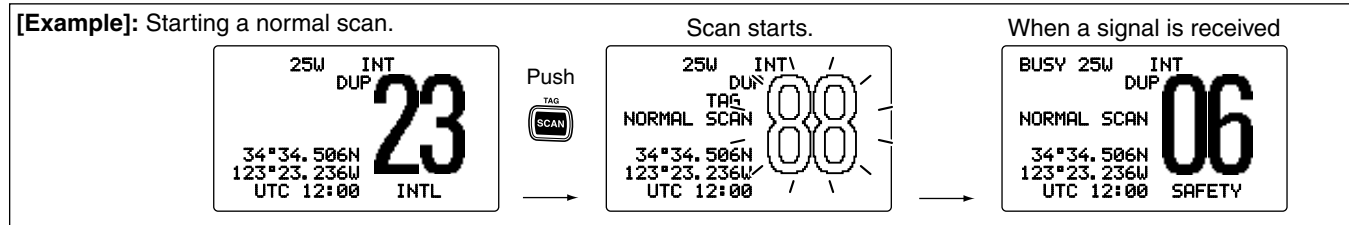

## ■ Description

Dualwatch monitors Channel 16 while you are receiving on another channel; Tri-watch monitors Channel 16 and the Call channel while receiving another channel. Dualwatch/Tri-watch is convenient for monitoring Channel 16 when you are operating on another channel.

### DUALWATCH/TRI-WATCH SIMULATION

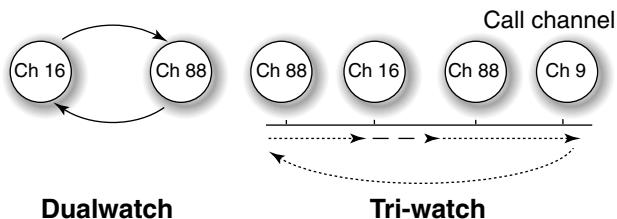

- If a signal is received on Channel 16, Dualwatch/Tri-watch pauses on Channel 16 until the signal disappears.
- If a signal is received on the Call channel during Tri-watch, Tri-watch becomes Dualwatch until the signal disappears.
- To transmit on the selected channel during Dualwatch/Tri-watch, hold down [PTT].

## ■ Operation

- ① Select Dualwatch or Tri-watch in Set mode. (p. 54)
- ② Rotate [DIAL] to select the desired operating channel.
- ③ Hold down [CH/WX•DUAL•U/I/C] for 1 second to start Dualwatch or Tri-watch.
  - “DUAL 16” appears during Dualwatch; “TRI 16” appears during Tri-watch.
  - A beep tone sounds when a signal is received on Channel 16.
- ④ To cancel Dualwatch/Tri-watch, push [CH/WX•DUAL•U/I/C] again.

**[Example]:** Operating Tri-watch on INT Channel 25

Tri-watch starts.

```

25W INT
  DUP
TRI 16 25
34°34.506N
123°23.236W
UTC 12:00 TELEPHONE
  
```

Signal is received on Call channel.

```

BUSY 25W INT CALL
      TAG
      TRI 16 09
34°34.506N
123°23.236W
UTC 12:00 CALLING
  
```

Tri-watch resumes after the signal disappears.

```

25W INT
  DUP
TRI 16 25
34°34.506N
123°23.236W
UTC 12:00 TELEPHONE
  
```

Signal received on Channel 16 takes priority.

```

BUSY 25W INT
      DUP
      TRI 16 25
34°34.506N
123°23.236W
UTC 12:00 TELEPHONE
  
```



## 6 DSC OPERATION

### ■ DSC address ID

A total of 100 DSC address IDs can be programmed and named with up to 10 characters.

#### ◇ Programming Individual ID

- ① Enter "Add: INDV ID" in the DSC Set up menu.

```
<DSC Menu> ⇨ <Set up> ⇨ <Add: INDV ID>
(Push [MENU]) (Rotate [DIAL], then push [DIAL•ENTER].)
```

- ② Rotate [DIAL] to input the individual ID and ID name.

- Push [16•9] to move the cursor forward, or [CH/WX•DUAL•U/IC] to move it backward.
- Push [CLR] to cancel and return to the DSC Set up menu.
- "Full ID" appears when 100 DSC address IDs are already set.
- After inputting the 9 digit code, push [DIAL•ENTER] or [16•9] to edit the ID name.

- /// The first digit is specified as '0' for a Group ID.
- /// The first two digits are '0' for any Coast station ID.

```
--DSC Menu--
Add: Individual ID
Input 9 digits
└─┬─┘
  █
└─┬─┘
  █
Input name
-----
<CLR>Exit / <ENT>OK>
```

- ③ After inputting the ID name, push [DIAL•ENTER] to program.
- ④ Push [CLR], or rotate [DIAL] to select "Exit" then push [DIAL•ENTER], to return to the DSC menu.
  - Repeat step ④ again to return to the normal operating mode.

#### ◇ Deleting Individual ID

- ① Enter "DEL: INDV ID" in the DSC Set up menu.

```
<DSC Menu> ⇨ <Set up> ⇨ <DEL: INDV ID>
(Push [MENU]) (Rotate [DIAL], then push [DIAL•ENTER].)
```

- When no address ID is programmed, "No ID" is displayed. In this case, push [CLR] to exit.

- ② Rotate [DIAL] to select the desired ID name to delete.

```
--DSC Menu--
Select ID
John
Paul
→George
Michael
<CLR>Exit / <ENT>OK>
```

- ③ Push [DIAL•ENTER] to delete the selected individual ID and return to the DSC Set up menu.
- ④ Push [CLR], or rotate [DIAL] to select "Exit" then push [DIAL•ENTER], to return to the DSC menu.
  - Repeat step ④ again to return to the normal operating mode.

### ◇ Programming Group ID

- ① Enter "Add: Group ID" in the DSC Set up menu.

```

<DSC Menu> ⇄ <Set up> ⇄ <Add:Group ID>
(Push [MENU]) (Rotate [DIAL], then push [DIAL•ENTER].)
    
```

- ② Rotate [DIAL] to input the group ID and ID name.
  - The group ID is a unique number that you create for your group. The ID name is an associated text name for that group.
  - Push [16•9] to move the cursor forward, or [CH/WX•DUAL•U/I/C] to move it backward.
  - Push [CLR] to cancel and return to the DSC Set up menu.
  - "Full ID" appears when 100 DSC address IDs are already set.
  - After inputting the 8 digit code, push [DIAL•ENTER] or [16•9] to edit the ID name.

- /// The first digit is specified as '0' for a Group ID.
- /// The first two digits are '0' for any Coast station ID.

```

--DSC Menu--
Add:Group ID
Input 8 digits
  █
Input name
-----
<CLR>Exit / ENT>OK>
    
```

- ③ After inputting the ID name, push [DIAL•ENTER] to program.
- ④ Push [CLR], or rotate [DIAL] to select "Exit" then push [DIAL•ENTER], to return to the DSC menu.
  - Repeat step ④ again to return to the normal operating mode.

### ◇ Deleting Group ID

- ① Enter "DEL: Group ID" in the DSC Set up menu.

```

<DSC Menu> ⇄ <Set up> ⇄ <DEL:Group ID>
(Push [MENU]) (Rotate [DIAL], then push [DIAL•ENTER].)
    
```

- When no address ID is programmed, "No ID" is displayed. In this case, push [CLR] to exit.

- ② Rotate [DIAL] to select the desired ID name to delete.

```

--DSC Menu--
Select ID
Icom
Group A
→Group B
Group C
<CLR>Exit / ENT>OK>
    
```

- ③ Push [DIAL•ENTER] to delete the selected group ID and return to the DSC Set up menu.
- ④ Push [CLR], or rotate [DIAL] to select "Exit" then push [DIAL•ENTER], to return to the DSC menu.
  - Repeat step ④ again to return to the normal operating mode.

### ■ Position and time programming

A Distress Call should include the ship's position and time data. If no GPS is connected, your position and UTC (Universal Time Coordinated) time should be manually input. They are automatically included when a GPS receiver (NMEA0183 ver. 2.0 or 3.01) is connected.

- ▧ • Manual programming is disabled when a GPS receiver (NMEA0183 ver. 2.0 or 3.01) is connected.
- ▧ • Manually programmed position/time data will be held for only 23.5 hours.

① Enter "Position Input" in the DSC menu.

```

<DSC Menu> ⇄ <Position Input>
(Push [MENU]) (Rotate [DIAL], then push [DIAL•ENTER].)
    
```

② Edit your position (latitude and longitude) data by rotating [DIAL].

- Push [16•9] to move the cursor forward, or [CH/WX•DUAL•U/I/C] to move it backward.
- Rotate [DIAL] to edit N; North latitude or S; South latitude when the cursor is on the 'N' or 'S' position.
- Rotate [DIAL] to edit W; West longitude or E; East longitude when the cursor is on the 'W' or 'E' position.
- Hold down [CLR] for 1 second to clear the latitude/longitude data.
- Push [CLR] to cancel and return to the DSC menu.

```

--DSC Menu--
Input Position
Latitude
> ■ . . . . . N      Null
Longitude
  ■ . . . . . W      Null
<CLR 1sec>Null Data>
<CLR>Exit / ENT>OK>
    
```

③ After editing the position data, push [DIAL•ENTER] to program. Rotate [DIAL] to edit the current UTC time, then push [DIAL3•ENTER].

- Push [16•9] to move the cursor forward, or [CH/WX•DUAL•U/I/C] to move it backward.
- Hold down [CLR] for 1 second to clear the UTC time data.
- Push [CLR] to cancel and return to the DSC menu.

```

--DSC Menu--
Input UTC Time
> ■ . . . . . Null
<CLR 1sec>Null Data>
<CLR>Exit / ENT>OK>
    
```

④ Push [CLR], or rotate [DIAL] to select "Exit" then push [DIAL•ENTER] to returns to the DSC menu.

- Repeat step ④ again to return to the normal operating mode.



## ■ Position and time indication

When a GPS receiver (NMEA0183 ver. 2.0 or 3.01) is connected, the transceiver displays the current position and time. When no GPS receiver is connected, the transceiver displays the manually entered position and time.

A GPS receiver appropriate for the IC-M504A is not supplied by Icom. A GPS receiver in NMEA0183 ver. 2.0 or 3.01 format is required for position and time indication. Ask your dealer about suitable GPS receivers.

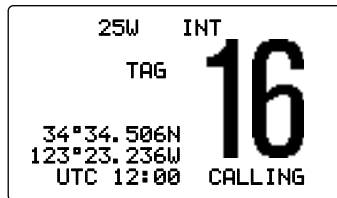

- ➔ With a receiver that is compatible with several sentence formats, the order of input precedence is 'RMC,' 'GGA,' 'GNS,' 'GLL' and 'VTG.'
- ➔ When sentence format 'RMC' is received, the time display includes a date. Thus, the "UTC" or "Local" icon is not displayed.
- ➔ "???" may blink instead of position and time displays when the GPS data is invalid, or has not been manually updated for 4 hours.
- ➔ A warning alarm sounds when the GPS data has been interrupted for 10 minutes, or has not been manually updated for 4 hours.

## ■ GPS information display

When a GPS receiver (NMEA0183 ver. 2.0 or 3.01) is connected, the transceiver displays the GPS information after holding down **[DIAL•ENTER]** for 1 second.

Hold down



for 1 second.

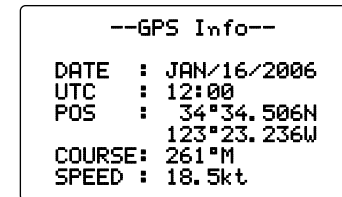

## 6 DSC OPERATION

### ■ Distress call

A Distress call should be transmitted, if in the opinion of the Master, the ship or a person is in distress and requires immediate assistance.

**NEVER USE THE DISTRESS CALL WHEN YOUR SHIP OR A PERSON IS NOT IN AN EMERGENCY. A DISTRESS CALL CAN BE USED ONLY WHEN IMMEDIATE HELP IS NEEDED.**

#### ◇ Simple call

- ① Confirm no Distress Call is being received.
- ② While lifting up the key cover, hold down **[DISTRESS]** for 5 seconds to transmit the Distress call.
  - Emergency channel (Channel 70) is automatically selected and the Distress call is transmitted.
  - When no GPS is connected, input your position and UTC time, if possible. (p. 44)
  - While holding down **[DISTRESS]**, the key backlighting blinks.

Distress Call  
Push for 5 sec.

- ③ After transmitting the call, the transceiver waits for an acknowledgment call.
  - The Distress Call is automatically transmitted every 3.5 to 4.5 minutes.
  - After 2 seconds, the transceiver is automatically set to Channel 16.

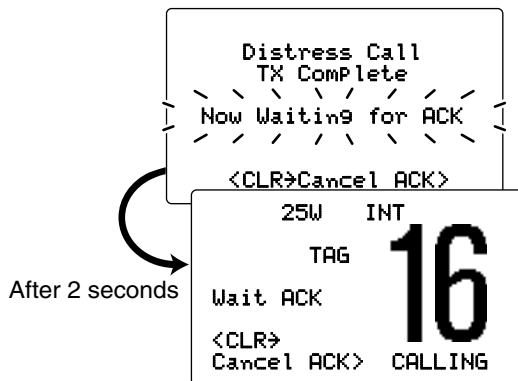

- ④ After receiving the acknowledgment, reply using the microphone.

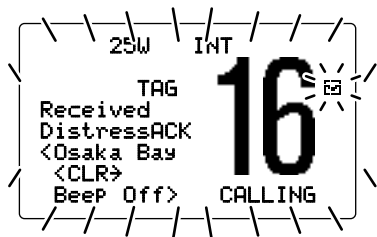

- ➔ A distress alert contains (default);
  - Kind of distress : Undesignated distress
  - Position data : The latest GPS or manual input position data is held for 23.5 hours, or until the power is turned OFF.
- ➔ The Distress call is repeated every 3.5 to 4.5 minutes, until an 'acknowledgement' is received. ('Call repeat' mode)
- ➔ Push **[DISTRESS]** to transmit a renewed Distress call, if required.
- ➔ Push **[CLR]** to transmit the Cancel Ack call, then cancel the 'Call repeat' mode.
- ➔ "???" may blink instead of position and time displays when the GPS data is invalid, or has not been manually updated for 4 hours.

### ◇ Regular call

The nature of the Distress call should be included in the Distress call.

- ① Enter "Distress Setting" in the DSC menu.

```

<DSC Menu> ⇄ <Distress Setting>
(Push [MENU]) (Rotate [DIAL], then push [DIAL•ENTER].)
```

- ② Rotate **[DIAL]** to select the nature of the distress, then push **[DIAL•ENTER]**.

- 'Undesignated,' 'Explosion,' 'Flooding,' 'Collision,' 'Grounding,' 'Capsizing,' 'Sinking,' 'Adrift (Disable adrift),' 'Abandoning (Abandoning ship),' 'Piracy (Piracy attack)' and 'MOB (Man overboard)' are available.
- The nature of the distress is stored for 10 minutes after a selection is made.

```

--DSC Menu--
Select Nature
Undesignated
→Explosion
Flooding
Collision

<CLR>Exit / ENT→OK>
```

- ⚡ When a GPS receiver (NMEA0183 ver. 2.0 or 3.01) is connected, steps ③ and ④ (Current position/time programming) do not appear. Go to step ⑤.

☞ Continued on the next page.



- ⑦ After receiving the acknowledgment, reply using the microphone.

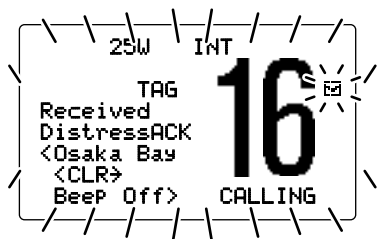

- ➔ A distress alert contains (default);
  - Kind of distress : Undesignated distress
  - Position data : The latest GPS or manual input position data is held for 23.5 hours, or until the power is turned OFF.
- ➔ The Distress call is repeated every 3.5 to 4.5 minutes, until an 'acknowledgement' is received. ('Call repeat' mode)
- ➔ Push **[DISTRESS]** to transmit a renewed Distress call, if required.
- ➔ Push **[CLR]** to transmit the Cancel Ack call, then cancel the 'Call repeat' mode.
- ➔ "??" may blink instead of position and time displays when the GPS data is invalid, or has not been manually updated for 4 hours.

## ■ Transmitting DSC calls

▨ To ensure correct operation of the DSC function, please make sure you set the squelch correctly. (p. 8)

### ◆ Transmitting an individual call

The Individual Call function allows you to transmit a DSC signal to only a specific ship.

- ① Enter "Individual Call" in the DSC menu.

```

<DSC Menu> ⇄ <Individual Call>
(Push [MENU]) (Rotate [DIAL], then push [DIAL•ENTER].)
```

- ② Rotate **[DIAL]** to select the desired pre-programmed individual address, or "Manual Input," then push **[DIAL•ENTER]**.

- The ID code for the Individual call can be set first. (p. 16)
- When "Manual Input" is selected, set the 9 digit MMSI ID code for the individual you wish to call with **[DIAL]**. (See 'About Manual Inputting' as described on the next page.)



▨ **NOTE:** When a base station is selected in step ②, the voice channel is automatically specified by the base station, then "Individual Call Ready" will appear. Therefore, skip step ③ and go directly to step ④.

➤ Continued on the next page.



- ⑥ When the acknowledgement 'Able to comply' is received, the channel specified in step ③ is selected and beeps automatically sound.

Or, when the acknowledgement 'Unable to comply' is received, beeps sound and the display returns to the operated channel (before you entered the DSC menu).

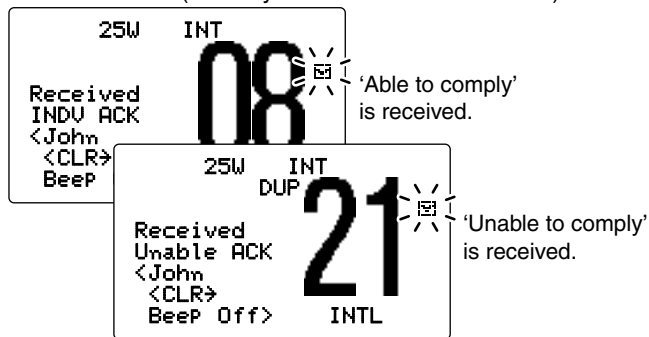

- ⑦ Push [CLR] to stop the beeps, then hold down [PTT] to communicate your message to the responding ship.

**✓ Convenient!**

When the Icom MA-500TR CLASS B AIS TRANSPONDER is connected to your transceiver, you can transmit individual DSC Calls to selected AIS targets on the transponder without needing to enter the target's MMSI code.

See the MA-500TR instruction manual for more details.

**◇ Transmitting an Individual Acknowledgement**

When receiving an Individual Call, you can transmit an acknowledgement ('Able to comply' or 'Unable to comply') by using the on screen prompts (Quick ACK.) Also, you can send an acknowledgement through the menu system (Manual ACK.)

**Quick ACK:**

- ➔ After an Individual call is received, push [CLR] to stop the beeps, and then push [DIAL•ENTER]. (Now go to step ③ on the next page.)

**Manual ACK:**

- ① Enter "Individual ACK" in the DSC menu.
  - "Individual ACK" item appears after an Individual Call is received.

```

<DSC Menu> ⇄ <Individual ACK>
(Push [MENU])      (Rotate [DIAL], then push [DIAL•ENTER].)
    
```

- ② Rotate [DIAL] to select the desired individual address or ID code, then push [DIAL•ENTER].

```

--DSC Menu--
Select Address
John
→Paul
George
Michael

<CLR>Exit / ENT→OK
    
```

☞ Continued on the next page.

## 6 DSC OPERATION

### ■ Transmitting DSC calls

#### ◇ Transmitting an Individual Acknowledgement (Continued)

- ③ Rotate **[DIAL]** to select “Able to Comply” or “Unable to Comply,” then push **[DIAL•ENTER]**.
  - When “Unable to Comply” is selected, ‘No Reason Given’ will be transmitted.
  - After pushing **[DIAL•ENTER]**, “Individual ACK Ready” is displayed.

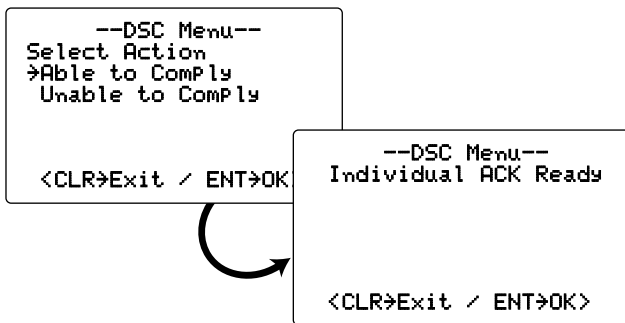

- ④ Push **[DIAL•ENTER]** to transmit the Acknowledgement Call to the selected station.
  - Emergency channel (Channel 70) is automatically selected.
  - If Channel 70 is busy, the transceiver stands by until the channel becomes clear.
- ⑤ After the call has been transmitted, the channel, specified by the calling station, is automatically selected when “Able to Comply” is selected in step ③. Or the display returns to the previous screen (before you entered the DSC menu) when “Unable to Comply” is selected.

#### ◇ Transmitting a Group Call

The Group Call function allows you to transmit a DSC signal to only a specific group.

- ① Enter “Group Call” in the DSC menu.

```
<DSC Menu> ⇄ <Group Call>
(Push [MENU]) (Rotate [DIAL], then push [DIAL•ENTER].)
```

- ② Rotate **[DIAL]** to select the desired pre-programmed group address or “Manual InPut,” then push **[DIAL•ENTER]**.
  - The ID code for the Group call can be set first. (p. 17)
  - When “Manual InPut” is selected, set the 8 digit ID code for the group you wish to call with **[DIAL]**. (See ‘About Manual Inputting’ as described to the right.)

```
--DSC Menu--
Select Address
  Manual InPut
  >Icom
  Group A

<CLR>Exit / ENT>OK
```





## 6 DSC OPERATION

### ◇ Transmitting an All Ships Call

Large ships use Channel 70 as their 'listening channel.' When you want to announce a message to these ships within range, use the 'All Ships Call' function.

- ① Enter "All Ships Call" in the DSC menu.

```
<DSC Menu> ⇄ <All Ships Call>
(Push [MENU]) (Rotate [DIAL], then push [DIAL•ENTER].)
```

- ② Rotate [DIAL] to select the desired category, then push [DIAL•ENTER].

• The selectable category may differ, depending on the programmed setting. Ask your dealer for the selectable categories.

```
--DSC Menu--
Select Category
→Safety
  Urgency

<CLR>Exit / <ENT>OK>
```

- ③ Rotate [DIAL] to select a desired Traffic channel, then push [DIAL•ENTER].

• The selected channel is displayed.  
• After pushing [DIAL•ENTER], "All Ships Call Ready" is displayed.

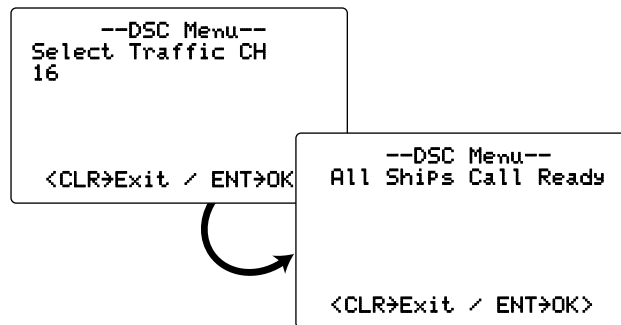

- ④ Push [DIAL•ENTER] to transmit the All Ships Call.
- Emergency channel (Channel 70) is automatically selected.
  - If Channel 70 is busy, the transceiver stands by until the channel becomes clear.
- ⑤ After the call has been transmitted, the following message is displayed.

```
--DSC Menu--
All Ships Call
TX Complete

<CLR>Exit>
```

- ⑥ Push [CLR] to exit, and the transceiver automatically selects the channel specified in step ③.
- Even if [CLR] hasn't been pushed, the transceiver automatically selects the specified channel in step ③ after 2 second of inactivity.

### ◇ Transmitting a Position Request Call

Transmit a Position Request Call when you want to know a specific ship's current position, etc.

- 1 Enter "Position Request" in the DSC menu.

```

<DSC Menu> ⇄ <Position Request>
(Push [MENU]) (Rotate [DIAL], then push [DIAL•ENTER].)

```

- 2 Rotate [DIAL] to select the desired pre-programmed individual address, or "Manual InPut," then push [DIAL•ENTER].

- The ID code for the Individual call can be set first. (p. 16)
- When "Manual InPut" is selected, set the 9 digit MMSI ID code for the individual you wish to call with [DIAL]. (See 'About Manual Inputting' as described on page 24.)
- After pushing [DIAL•ENTER], "POS Request Ready" is displayed.

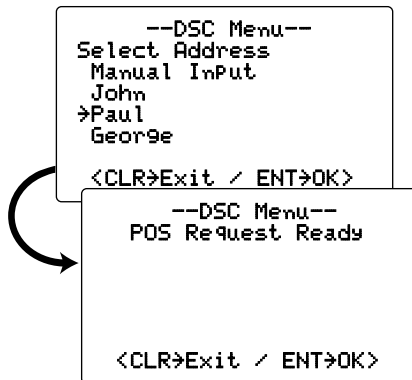

- 3 Push [DIAL•ENTER] to transmit the Position Request Call.
  - Emergency channel (Channel 70) is automatically selected.
  - If Channel 70 is busy, the transceiver stands by until the channel becomes clear.
- 4 After the Position Request Call has been transmitted, the following message is displayed.

```

--DSC Menu--
Position Request
TX Complete

```

```

<CLR>Exit>

```

- 5 Push [CLR] to return to the previous screen before you entered the DSC menu.
  - Even if [CLR] hasn't been pushed, the display automatically returns to the previous screen after 2 second of inactivity.

## 6 DSC OPERATION

### ◇ Transmitting a Position Report Call

Transmit a Position Report Call when you want to announce your own position to a specific ship and receive an answer back.

- ① Enter "Position Report" in the DSC menu.

```
<DSC Menu> ⇄ <Position Report>
(Push [MENU]) (Rotate [DIAL], then push [DIAL•ENTER].)
```

- ② Rotate [DIAL] to select the desired pre-programmed individual address, or "Manual Input," then push [DIAL•ENTER].

- The ID code for the Individual call can be set first. (p. 16)
- When "Manual Input" is selected, set the 9 digit MMSI ID code for the individual you wish to call with [DIAL]. (See 'About Manual Inputting' as described on page 24.)

```
--DSC Menu--
Select Address
Manual Input
John
→Paul
George
<CLR>Exit / ENT>OK>
```

When a GPS receiver (NMEA0183 ver. 2.0 or 3.01) is connected, next steps ③ and ④ (Current position/time programming) do not appear. Go to step ⑤.

- ③ The position information appears. Rotate [DIAL] to edit your position data (latitude and longitude). (p. 18)

- ④ After editing the position data, push [DIAL•ENTER] to program. Rotate [DIAL] to edit the current UTC time, then push [DIAL•ENTER]. (p. 18)

- After pushing [DIAL•ENTER], "Position Report Ready" is displayed.

```
--DSC Menu--
Position RePort Ready
```

```
<CLR>Exit / ENT>OK>
```

- ⑤ Push [DIAL•ENTER] to transmit the Position Report Call.
- Emergency channel (Channel 70) is automatically selected.
  - If Channel 70 is busy, the transceiver stands by until the channel becomes clear.
- ⑥ After the Position Report Call has been transmitted, the following message is displayed.

```
--DSC Menu--
Position RePort
TX Complete
```

```
<CLR>Exit>
```

- ⑦ Push [CLR] to return to the previous screen before you entered the DSC menu.
- Even if [CLR] hasn't been pushed, the display automatically returns to the previous screen after 2 seconds of inactivity.

### ◇ Transmitting a Polling Request Call

Transmit a Polling Request Call when you want to know a specific vessel is in the communication area, or not.

- ① Enter "Polling Request" in the DSC menu.

```
<DSC Menu> ⇄ <Polling Request>
(Push [MENU]) (Rotate [DIAL], then push [DIAL•ENTER].)
```

- ② Rotate [DIAL] to select the desired pre-programmed individual address, or "Manual Input," then push [DIAL•ENTER].

- The ID code for the Individual call can be set first. (p. 16)
- When "Manual Input" is selected, set the 9 digit MMSI ID code for the individual you wish to call with [DIAL]. (See 'About Manual Inputting' as described on page 24.)
- After pushing [DIAL•ENTER], "Polling Request Ready" is displayed.

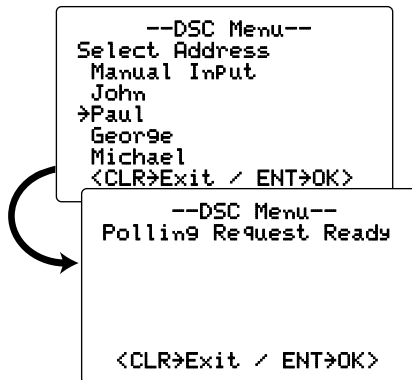

- ③ Push [DIAL•ENTER] to transmit the Polling Request Call.
- Emergency channel (Channel 70) is automatically selected.
  - If Channel 70 is busy, the transceiver stands by until the channel becomes clear.
- ④ After the Polling Request Call has been transmitted, the following message is displayed.

```
--DSC Menu--
Polling Request
TX Complete
```

```
<CLR>Exit
```

- ⑤ Push [CLR] to return to the previous screen before you entered the DSC menu.
- Even if [CLR] hasn't been pushed, the display automatically returns to the previous screen after 2 seconds of inactivity.

## 6 DSC OPERATION

### ◇ Transmitting a Position Reply Call

Transmit a Position Reply Call when a Position Request Call is received.

When the Automatic Acknowledgement function is ON (p. 45), the transceiver automatically transmits a reply call after receiving a Position Request Call.

- ① Enter "Position Reply" in the DSC menu.

• "Position Reply" item appears after a position request call is received.

```
<DSC Menu> ⇄ <Position Reply>
(Push [MENU]) (Rotate [DIAL], then push [DIAL•ENTER].)
```

- ② Rotate [DIAL] to select the desired individual address or ID code, then push [DIAL•ENTER].

```
--DSC Menu--
Select Address
 John
→Paul
 George
 Michael

<CLR>Exit / ENT>OK>
```

When a GPS receiver (NMEA0183 ver. 2.0 or 3.01) is connected, next steps ③ and ④ (Current position/time programming) do not appear. Go to step ⑤.

- ③ The position information appears. Rotate [DIAL] to edit your position data (latitude and longitude). (p. 18)

- ④ After editing the position data, push [DIAL•ENTER] to program. Rotate [DIAL] to edit the current UTC time, then push [DIAL•ENTER]. (p. 18)

• After pushing [DIAL•ENTER], "Position Reply Ready" is displayed.

```
--DSC Menu--
Position Reply Ready
```

```
<CLR>Exit / ENT>OK>
```

- ⑤ Push [DIAL•ENTER] to transmit the Position Reply Call to the selected station.

- Your position data is transmitted.
- Emergency channel (Channel 70) is automatically selected.
- If Channel 70 is busy, the transceiver stands by until the channel becomes clear.

### ◇ Transmitting a Position Report Reply call

Transmit a Position Report Reply Call when a Position Report Call\* is received.

When the Automatic Acknowledgement function is ON (p. 45), the transceiver automatically transmits a reply call after receiving a Position Report call\*.

\*Only when the received Position Report call requires a reply,

- ① Enter "POS Report Reply" in the DSC menu.
  - "POS Report Reply" item appears after a Position Report Call is received.

```

<DSC Menu> ⇄ <POS Report Reply>
(Push [MENU]) (Rotate [DIAL], then push [DIAL•ENTER].)

```

- ② Rotate [DIAL] to select the desired individual address or ID code, then push [DIAL•ENTER].
  - After pushing [DIAL•ENTER], "POS REP Reply Ready" is displayed.

```

--DSC Menu--
POS REP Reply Ready

```

```

<CLR>Exit / <ENT>OK>

```

- ③ Push [DIAL•ENTER] to transmit the Position Report Reply Call to the selected station.
  - Emergency channel (Channel 70) is automatically selected.
  - If Channel 70 is busy, the transceiver stands by until the channel becomes clear.

### ◇ Transmitting a Polling Reply Call

Transmit a Polling Reply Call when a Polling Request Call is received.

When the Automatic Acknowledgement function is ON (p. 45), the transceiver automatically transmits a reply call after receiving a Polling Request call.

- ① Enter "Polling Reply" in the DSC menu.
  - "Polling Reply" item appears after a polling request call is received.

```

<DSC Menu> ⇄ <Polling Reply>
(Push [MENU]) (Rotate [DIAL], then push [DIAL•ENTER].)

```

- ② Rotate [DIAL] to select the desired individual address or ID code, then push [DIAL•ENTER].
  - After pushing [DIAL•ENTER], "Polling Reply Ready" is displayed.

```

--DSC Menu--
Polling Reply Ready

```

```

<CLR>Exit / <ENT>OK>

```

- ③ Push [DIAL•ENTER] to transmit the Polling Reply call to the selected station.
  - Emergency channel (Channel 70) is automatically selected.
  - If Channel 70 is busy, the transceiver stands by until the channel becomes clear.

## 6 DSC OPERATION

### ◇ Test call

Testing on the exclusive DSC distress and safety calling channels should be avoided as much as possible. When testing on the distress/safety channel is unavoidable, you should indicate that these are test transmissions.

Normally the test call would require no further communications between the two stations involved.

- ① Enter "Test Call" in the DSC menu.

```
<DSC Menu> ⇄ <Test Call>
(Push [MENU]) (Rotate [DIAL], then push [DIAL•ENTER].)
```

- ② Rotate [DIAL] to select the desired pre-programmed individual address, or "Manual Input," then push [DIAL•ENTER].

- The ID code for the Individual call can be set first. (p. 16)
- When "Manual Input" is selected, set the 9 digit MMSI ID code for the individual you wish to call with [DIAL]. (See 'About Manual Inputting' as described on page 24.)
- After pushing [DIAL•ENTER], "Test Call Ready" is displayed.

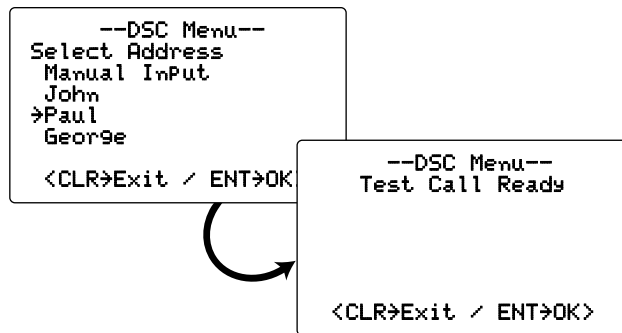

- ③ Push [DIAL•ENTER] to transmit the Test call.
  - Emergency channel (Channel 70) is automatically selected.
  - If Channel 70 is busy, the transceiver stands by until the channel becomes clear.
- ④ After the Test call has been transmitted, the display automatically returns to the previous screen (before you entered the DSC menu).



### ◇ Transmitting a Test Ack call

Transmit a Test Acknowledgement call when a Test call is received.

- Enter "Test ACK" in the DSC menu.
  - "Test ACK" item appears after a Test call is received.

```

<DSC Menu> → <Test ACK>
(Push [MENU])      (Rotate [DIAL], then push [DIAL•ENTER].)
    
```

- Rotate [DIAL] to select the desired individual address or ID code, then push [DIAL•ENTER].
  - After pushing [DIAL•ENTER], "Test ACK Ready" is displayed.

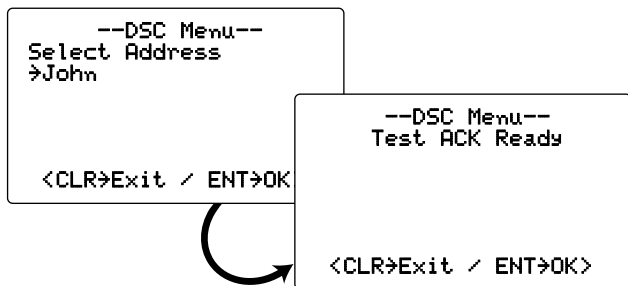

- Push [DIAL•ENTER] to transmit the Test Ack call.
  - Emergency channel (Channel 70) is automatically selected.
  - If Channel 70 is busy, the transceiver stands by until the channel becomes clear.
- After the Test Ack call has been transmitted, the display automatically returns to the previous screen (before you entered the DSC menu).

## ■ Receiving DSC calls

### ◇ Receiving a Distress Call

When a Distress Call is received:

- The emergency alarm sounds.
- "☒" and the LCD backlight blink.
  - Push [CLR] to stop the beeps and the backlight blinking. ("☒" continues to blink.)
- "Received Distress" appears on the display, then Channel 16 is automatically selected.
  - This action can be changed, depending on the combination of the Auto Switch function and Auto Tune timer settings. See pages 46 and 47 for more details.
- Continue monitoring Channel 16 as a coast station may require assistance.

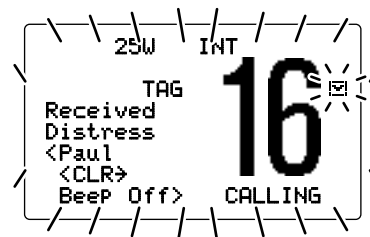



## 6 DSC OPERATION

### ■ Receiving DSC calls (Continued)

#### ◇ Receiving a Distress Acknowledgement

When a Distress Acknowledgement to other ship is received:

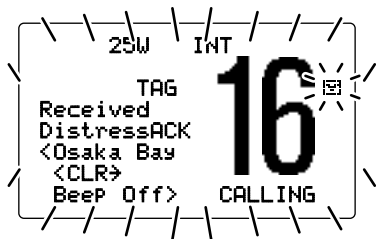

- The emergency alarm sounds.
- “” and the LCD backlight blink.
  - Push [CLR] to stop the beeps and the backlight blinking. (“” continues to blink.)
- “Received DistressACK” appears on the display, then Channel 16 is automatically selected.

▨ This action can be changed, depending on the combination of the Auto Switch function and Auto Tune timer settings. See pages 46 and 47 for more details.



#### ◇ Receiving a Distress Relay Call

When a Distress Relay call is received:

- The emergency alarm sounds.
- “” and the LCD backlight blink.
  - Push [CLR] to stop the beeps and the backlight blinking. (“” continues to blink.)
- “Received DistressRLY” appears on the display, then Channel 16 is automatically selected.

▨ This action can be changed, depending on the combination of the Auto Switch function and Auto Tune timer settings. See pages 46 and 47 for more details.

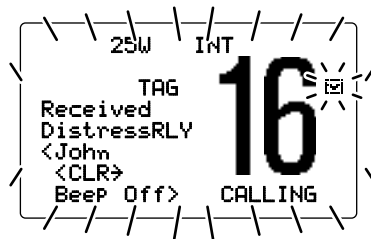

### ◇ Receiving a Distress Relay Acknowledgement

When a Distress Relay Acknowledgement is received:

- ➔ The emergency alarm sounds.
- ➔ “☒” and the LCD backlight blink.
  - Push **[CLR]** to stop the beeps and the backlight blinking. (“☒” continues to blink.)
- ➔ “DTR RLY ACK” appears on the display, then Channel 16 is automatically selected.

▨ This action can be changed, depending on the combination of the Auto Switch function and Auto Tune timer settings. See pages 46 and 47 for more details.

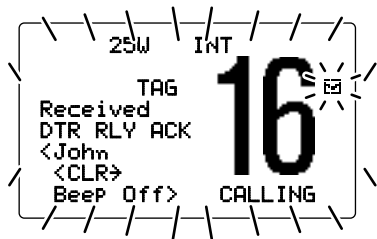

▨ **NOTE:** The alarm does not sound within 1 hour from receiving the distress relay or distress relay acknowledgement call if receiving the duplicate call.

### ◇ Receiving an Individual Call

When an Individual Call is received:

- ➔ The emergency alarm or beeps sound depending on the received category.
- ➔ “Received Individual” appears on the display.
- ➔ “☒” and the LCD backlight blink.
- ➔ Push **[CLR]** to stop the beeps and the backlight blinking, then push **[DIAL•ENTER]** to reply to the call and select the channel specified by the calling station for voice communication (depending on your situation; see page 25 for details of the Individual Acknowledgement procedure.); push **[CLR]** to ignore the call.
  - “☒” continues to blink.

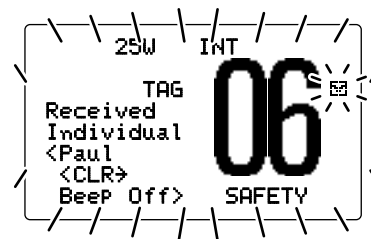



## 6 DSC OPERATION

### ■ Receiving DSC calls (Continued)

#### ◇ Receiving a Group Call



When a Group Call is received:

- The emergency alarm or beeps sound depending on the received category.
- “Received Group” appears on the display.
- “” and the LCD backlight blink.
- Push [CLR] to stop the beeps and the backlight blinking, then push [DIAL•ENTER] to monitor the specified channel for an announcement from the calling vessel; push [CLR] to ignore the call.
  - “” continues to blink.



#### ◇ Receiving an All Ships Call

When an All Ships Call is received:

- The emergency alarm sounds when the category is 'Distress' or 'Urgency'; 2 beeps sound for other categories.
- “Received All Ships” appears on the display.
- “” and the LCD backlight blink.
- Push [CLR] to stop the beeps and the backlight blinking, then push [DIAL•ENTER] to monitor channel 16 for an announcement from the calling vessel, push [CLR] to ignore the call.
  - “” continues to blink.



### ◇ Receiving a Geographical Area Call

When a Geographical Area Call (for the area you are in) is received:

- ➔ Emergency alarm or beeps sound depending on the received category.
- ➔ “Received GeographiC” appears on the display.
- ➔ “06” and the LCD backlight blink.
- ➔ Push [CLR] to stop the beeps and the backlight blinking, then push [DIAL•ENTER] to change to the channel specified by the calling station for voice communication; push other key to ignore the call.
  - “06” continues to blink.
- ➔ Monitor the selected channel for an announcement from the calling station.



When no GPS receiver is connected or if there is a problem with the connected receiver, all Geographical Area Calls are received, regardless of your position.

### ◇ Receiving a Position Request Call

When a Position Request Call is received:

- ➔ The beeps sound.
- ➔ “Received POS Request” appears on the display.
- ➔ “06” and the LCD backlight blink.
- ➔ Push [CLR] to stop the beeps and the backlight blinking, then push [DIAL•ENTER] to reply to the call; push [CLR] to ignore the call.
  - “06” continues to blink.

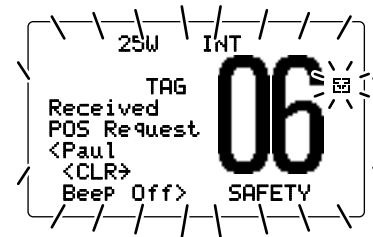

## 6 DSC OPERATION

### ■ Receiving DSC calls (Continued)

#### ◇ Receiving a Position Report Call

When a Position Report Call is received:

- The beeps sound.
- “Received POS RePort” appears on the display.
- “☒” and the LCD backlight blink.
- Push **[CLR]** to stop the beeps and the backlight blinking, then push **[DIAL•ENTER]** to display the position information, or push **[CLR]** to exit the screen.
  - If the received call requires a reply, push **[DIAL•ENTER]** to send a reply to the call. After sending, push **[DIAL•ENTER]** to display the position information, or push **[CLR]** to exit the screen.
  - “☒” continues to blink.



#### ◇ Receiving a Polling Request call

When a Polling Request call is received:

- The beeps sound.
- “Received POLL REQ” appears on the display.
- “☒” and the LCD backlight blink.
- Push **[CLR]** to stop the beeps and the backlight blinking, then push **[DIAL•ENTER]** to reply to the call; push **[CLR]** to ignore the call.
  - “☒” continues to blink.



#### ◇ Receiving a Position Reply Call

When a Position Reply call is received:

- The beeps sound.
- “Received POS RePlY” appears on the display.
- “☒” and the LCD backlight blink.
- Push **[CLR]** to stop the beeps and the backlight blinking, then push **[DIAL•ENTER]** to display the position information; push **[CLR]** to exit the screen.
  - “☒” continues to blink.



### ◇ Receiving a Position Report Reply call

When a Position Report Reply Call is received:

- ➔ The beeps sound.
- ➔ “Received POS RePl y” appears on the display.
- ➔ “S” and the LCD backlight blink.
- ➔ Push [CLR] to stop the beeps and the backlight blinking, then push [DIAL•ENTER] to display the position information, or push [CLR] to exit the screen.
  - “S” continues to blink.



### ◇ Receiving a Polling Reply Call

When a Polling Reply Call is received:

- ➔ The beeps sound.
- ➔ “Received POLL RePl y” appears on the display.
- ➔ “S” and the LCD backlight blink.
- ➔ Push [CLR] to stop the beeps and the backlight blinking, then push [CLR] again to exit the screen.
  - “S” continues to blink.

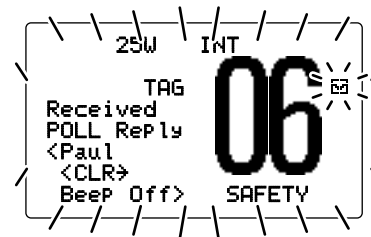

## 6 DSC OPERATION

### ■ Receiving DSC calls (Continued)

#### ◇ Receiving a Test Call

When a Test Call is received:

- The beeps sound.
- “Received Test Call” appears on the display.
- “06” and the LCD backlight blink.
- Push **[CLR]** to stop the beeps and the backlight blinking, then push **[DIAL•ENTER]** to reply to the call; push **[CLR]** to ignore the call.
  - “06” continues to blink.

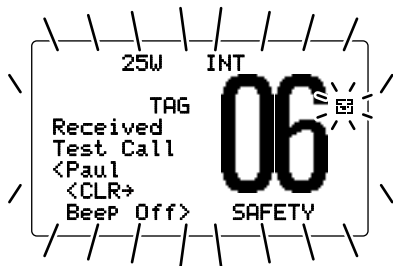

#### ◇ Receiving a Test Acknowledgement Call

When a Test Acknowledgement Call is received:

- The beeps sound.
- “Received Test ACK” appears on the display.
- “06” and the LCD backlight blink.
- Push **[CLR]** to stop the beeps and the backlight blinking, then push **[CLR]** again to exit the screen.
  - “06” continues to blink.

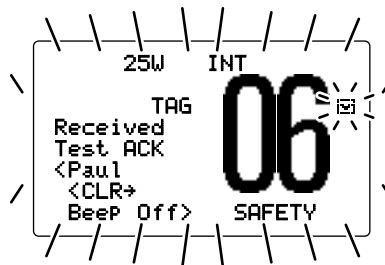



## ■ Received messages

The transceiver automatically stores up to 20 distress messages and 20 other messages. The messages can be used as a supplement to your logbook.

- “

### ◇ Distress message

- ① Enter “Distress” in the DSC menu.

- The messages are stored in “Distress,” if its format specifier is ‘Distress.’

```
<DSC Menu> ⇨ <Received Call Log> ⇨ <Distress>
(Push [MENU]) (Rotate [DIAL], then push [DIAL•ENTER].)
```

- ② Rotate [DIAL] to select the desired item, then push [DIAL•ENTER].

- Blinking item’s message has not been read.

```
--DSC Menu--
Select Item
=>12:15 John
<07:13 George

<CLR>Exit / ENT>OK>
```

- ③ Rotate [DIAL] to scroll the message contents.

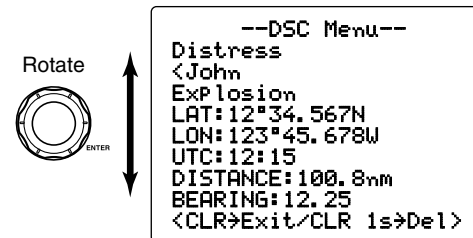

- ④ Push [CLR] to exit, or hold down [CLR] for 1 second to delete the displayed message and return to the DSC menu.
- ⑤ Push [CLR], or rotate [DIAL] to select “Exit” then push [DIAL•ENTER], to return to the normal operating mode.

## 6 DSC OPERATION

### ■ Received messages (Continued)

#### ◇ Other messages

- ① Enter "Other" in the DSC menu.
  - The messages are stored in "Other," if its format specifier is other than 'Distress.'

```
<DSC Menu> ⇨ <Received Call Log> ⇨ <Other>
(Push [MENU]) (Rotate [DIAL], then push [DIAL•ENTER].)
```

- ② Rotate [DIAL] to select the desired message, then push [DIAL•ENTER].
  - Blinking messages have not been read.

```
--DSC Menu--
Select Message
>Individual Call
Group Call
Position Replay
All Ships Call

<CLR>Exit / <ENT>OK
```

- ③ Rotate [DIAL] to scroll the message contents.
  - The stored message has various information, depending on the DSC call type.
- ④ Push [CLR] to exit, or hold down [CLR] for 1 second to delete the displayed message and return to the DSC menu.
- ⑤ Push [CLR], or rotate [DIAL] to select "Exit" then push [DIAL•ENTER], to return to the normal operating mode.

## ■ DSC Set up menu

- ◇ Add Individual ID/Group ID (See pages 16, 17)
- ◇ Delete Individual ID/Group ID (See pages 16, 17)

#### ◇ Offset time

This item sets the offset time from the UTC (Universal Time Coordinated) time.

- ① Enter "Offset Time" in the DSC Set up menu.

```
<DSC Menu> ⇨ <Set up> ⇨ <Offset Time>
(Push [MENU]) (Rotate [DIAL], then push [DIAL•ENTER].)
```

- ② Rotate [DIAL] to edit the offset time from the UTC (Universal Time Coordinated) time.
  - Push [16•9] to move the cursor forward, or [CH/WX•DUAL•U/IC] to move it backward.
  - Push [CLR] to cancel and return to the DSC Set up menu.

```
--DSC Menu--
Input Offset Time
■ 0:00

<CLR>Exit / <ENT>OK
```

No offset time (default)

```
--DSC Menu--
Input Offset Time
+12:00

<CLR>Exit / <ENT>OK
```

+12 hours

- ③ After editing, push [DIAL•ENTER] to program.
- ④ Push [CLR], or rotate [DIAL] to select "Exit" then push [DIAL•ENTER], to return to the DSC menu.
  - Repeat step ④ again to return to the normal operating mode.

### ◇ MMSI code check

The programmed 9 digit MMSI (DSC self ID) code can be checked.

- ① Enter "MMSI Check" in the DSC Set up menu.

```

<DSC Menu> ⇨ <Set up> ⇨ <MMSI Check>
(Push [MENU])      (Rotate [DIAL], then push [DIAL•ENTER].)
  
```

- ② Check the 9 digit MMSI (DSC self ID) code.

```

--DSC Menu--
MMSI Check
123456789

<CLR>Exit
  
```

- ③ Push [CLR] to return to the DSC Set up menu.
- ④ Push [CLR], or rotate [DIAL] to select "Exit" then push [DIAL•ENTER], to return to the DSC menu.
  - Repeat step ④ again to return to the normal operating mode.

### ◇ Automatic Acknowledgement

This item sets the Automatic Acknowledgement function to ON or OFF.

When a Position Request, Position Report, Polling Request or Test Call is received, the transceiver automatically transmits a Position Reply, Position Report Reply\*, Polling Reply or Test Acknowledgement Call, respectively.

\*Only when the received Position Report call requires a reply.

- ① Enter "Position Auto ACK" in the DSC Set up menu.

```

<DSC Menu> ⇨ <Set up> ⇨ <Position Auto ACK>
(Push [MENU])      (Rotate [DIAL], then push [DIAL•ENTER].)
  
```

- ② Rotate [DIAL] to turn the Automatic Acknowledgement function ON or OFF.

```

--DSC Menu--
Position Auto ACK
→ON
OFF

<CLR>Exit / ENT→OK
  
```

(Default: ON)

- ③ Push [DIAL•ENTER] to set and return to the DSC Set up menu.
  - Push [CLR] to cancel and return to the DSC Set up menu.
- ④ Push [CLR], or rotate [DIAL] to select "Exit" then push [DIAL•ENTER], to return to the DSC menu.
  - Repeat step ④ again to return to the normal operating mode.

## 6 DSC OPERATION

### ■ DSC Set mode (Continued)

#### ◇ NMEA Output

Select an NMEA Output function. When receiving a position acknowledgment, the transceiver outputs it to external equipment through the NMEA connector.

- ① Enter "NMEA Output" in the DSC Set up menu.

```
<DSC Menu> ⇄ <Set up> ⇄ <NMEA Output>
(Push [MENU]) (Rotate [DIAL], then push [DIAL•ENTER].)
```

- ② Rotate [DIAL] to select the NMEA Output function from List Station, All Station or OFF.

- List Station: Outputs the position data from the specified vessels listed on the DSC individual ID screen.
- All Station : Outputs the position data from all vessels.
- OFF : Outputs no position data to the external equipment.

```
--DSC Menu--
NMEA Output
→List Station
All Station
OFF

<CLR>Exit / ENT→OK>
```

(Default: List Station)

- ③ Push [DIAL•ENTER] to set and return to the DSC Set up menu.

- Push [CLR] to cancel and return to the DSC Set up menu.

- ④ Push [CLR], or rotate [DIAL] to select "Exit" then push [DIAL•ENTER], to return to the DSC menu.

- Repeat step ④ again to return to the normal operating mode

#### ◇ Auto Switch function

By regulation, after receiving a Distress call, the transceiver switches the operating channel to Channel 16. However, when this setting is set to "OFF," the function enables the transceiver to remain on the operating channel, even after receiving a Distress call.

- ① Enter "Auto SW" in the DSC Set up menu.

```
<DSC Menu> ⇄ <Set up> ⇄ <Auto SW>
(Push [MENU]) (Rotate [DIAL], then push [DIAL•ENTER].)
```

- ② Rotate [DIAL] to turn the Auto switch "ON" or "OFF."

**ON** : After receiving a Distress call, the transceiver automatically switches the operating channel to Channel 16.

**OFF** : Even after receiving a Distress call, the transceiver remains on the operating channel.

```
--DSC Menu--
Auto SW
ON
→OFF

<CLR>Exit / ENT→OK>
```

(Default: OFF)

- ③ Push [DIAL•ENTER] to set and return to the DSC Set up menu.

- Push [CLR] to cancel and return to the DSC Set up menu.

- ④ Push [CLR], or rotate [DIAL] to select "Exit" then push [DIAL•ENTER], to return to the DSC menu.

- Repeat step ④ again to return to the normal operating mode

◇ **Auto Tune timer**

This is the amount of time after receiving a Distress call before the transceiver switches to Channel 16.

- 1 Enter "Auto Tune" in the DSC Set up menu.

```

<DSC Menu> ⇨ <Set up> ⇨ <Auto Tune>
(Push [MENU]) (Rotate [DIAL], then push [DIAL•ENTER].)
    
```

- 2 Rotate [DIAL] to turn the Auto Tune timer "ON" or "OFF:"

**ON** : After receiving a Distress call, the transceiver remains on the operating channel for 10 seconds, and then automatically switches to Channel 16.

Within 10 seconds, the following action can be taken:

- Push [DIAL•ENTER] to immediately switch to Channel 16.
- Push [CLR] to cancel the Auto tune timer, and the transceiver remains on the operating channel.

**OFF** : Turns OFF the Auto Tune timer.

```

--DSC Menu--
Auto Tune
→ON
OFF

<CLR>Exit / ENT>OK
    
```

(Default: ON)

- 3 Push [DIAL•ENTER] to set and exit the setting.
  - Push [CLR] to cancel and exit the setting, if desired.

The action of the transceiver may differ, depending on the combination of the Auto Switch function and the Auto Tune timer settings as listed below.

• **Combined operation when receiving a DSC Call:**

		Auto Switch	
		OFF	ON
Auto tune	OFF	The transceiver remains on the operating channel. • "Ⓢ" blinks.	The transceiver automatically switches to Channel 16.
	ON	The transceiver remains on the operating channel for 10 seconds, and then automatically switches to Channel 16. Within 10 seconds, the following action can be taken: • When [DIAL•ENTER] is pushed, immediately switches to Channel 16. • When [CLR] is pushed, remains on the operating channel since the Auto Tuner timer is cancelled.	

## ■ Intercom operation

The optional Intercom function allows you to talk to the deck from the cabin. The optional Command microphone is required for Intercom operation.

Connect an optional Command microphone as described on page 62.

- Transmitting is impossible while using the intercom.
- The received signal is muted while using the intercom.

- ① Push **[POWER]** to turn ON the power.
  - The optional Command microphone power is automatically turned ON, even if the power is OFF.
- ② Hold down **[LO/DX•IC•SCRM]** for 1 second to enter the Intercom mode.



IC-M504A/HM-162



HM-157

- ③ Hold down **[LO/DX•IC•SCRM]** for 1 second to sound the intercom beep.
  - The transceiver and the optional Command microphone sound beeps while holding down **[LO/DX•IC•SCRM]**.

- ④ Hold down **[PTT]** and speak into the microphone at a normal voice level.
  - “TALK” or “LISTEN”\* appears on the caller or listener function display, respectively.
  - \* “TALK” or “LSTN” appears on the HM-157.
  - To adjust the IC-M504A’s speaker output level, rotate **[VOL]**.
  - To adjust the HM-162’s speaker output level, rotate **[SELECTOR]** after pushing **[VOL]** on the HM-162.
  - To adjust the HM-157’s speaker output level, push **[VOL•DIM PA/RX ◀▶]**, then push **[▲]** or **[▼]** on the HM-157.



IC-M504A (caller)



HM-162 (listener)



HM-157 (listener)

- ⑤ After releasing **[PTT]** you can hear the response through the speaker.
- ⑥ To return to the normal operating mode, push **[CLR]** or push **[LO/DX•IC•SCRM]** momentarily.

- While in the Intercom mode, the transceiver's transmit and receive functions are interrupted. If the transceiver is in the transmit mode, the Intercom function is not available.
- When a DSC Call is received, the Intercom mode is automatically cancelled. The received call type is displayed on the LCD. (p. 35)
- When a WX alert is received, "WX ALERT" blinks and a beep sounds. The WX alert sounds after exiting from the Intercom mode.

## ■ RX Speaker function

The IC-M504A has an RX Speaker function. When this function is turned ON, the received audio can be heard on the deck or tower through a hailer speaker.

Connect a hailer speaker as described on page 56.

- ① Hold down **[HAIL•RX◀▶]** for 1 second to enter the RX Speaker mode.
  - "RX◀▶" appears.

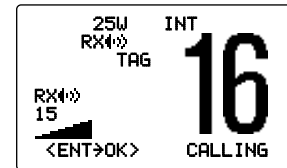

- ② Rotate **[DIAL]** to adjust the audio output level, then push **[DIAL•ENTER]**.
- ③ To return to normal operating mode, hold down **[HAIL•RX◀▶]** for 1 second.
  - "RX◀▶" disappears.

To adjust the audio output level in the RX Speaker mode, while holding down **[HAIL•RX◀▶]**, rotate **[DIAL]**. After adjusting, push **[DIAL•ENTER]**.

- Rotate **[DIAL]** within 1 second after holding down **[HAIL•RX◀▶]**. Otherwise the transceiver returns to the normal operation mode.

## 7 OTHER FUNCTIONS

### ■ Hailer operation

The IC-M504A has a Hailer function for voice amplification over a loudspeaker, making it unnecessary to leave the bridge to talk a hailing party.

Connect an external hailer speaker (25 W nominal at 13.8 V/ 4 Ω) as described on page 56.

- Transmitting is not possible during hailer operation.
- The received signal is muted during hailer operation.

① Push [**HAIL•RX** 





- ② Hold down [**PTT**] and speak into the microphone at a normal voice level.
- "TALK" appears.
  - "WAIT" appears on the display while holding down [**PTT**] of the optional Command microphone.
  - To adjust the hailer level, rotate [**DIAL**].
- ③ After releasing [**PTT**], you can hear the response through the speaker.
- ④ To return to normal operating mode, push [**CLR**] or push [**HAIL•RX** 
  - While in the Hailer mode, the transceiver's transmit and receive functions are interrupted. If the transceiver is in the transmit mode, the Hailer function is not available.
  - When a DSC Call is received, the Hailer mode is automatically cancelled. The received call type is displayed on the LCD. (p. 35)



## ■ Automatic Foghorn function

The Automatic Foghorn function repeatedly sounds a horn until the function is turned OFF. Four patterns are selectable for varying situations.

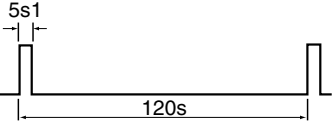
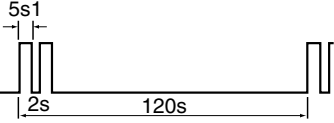
The hailer speaker is used to sound the foghorn. To use this function, the hailer speaker must be connected to the transceiver. See page 56 for connection details.

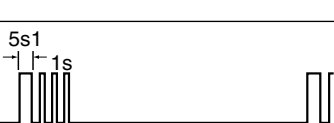
TYPE	PATTERN	USAGE
<b>UNDERWAY</b>	One 5-second blasts every 120 seconds. 	Motor vessel underway and making way.
<b>STOP</b>	Two 5-second blasts (separated by 2 seconds) every 120 seconds. 	Motor vessel underway but stopped (not making way).
<b>SAIL</b>	One 5-second blast followed by two 1-second blasts (each separated by 2 seconds) every 120 seconds. 	Sailing vessel underway, fishing vessel (underway or anchored), vessel not under command, a vessel restricted in her ability to maneuver (underway or at anchor), or a vessel towing or pushing another ahead.
<b>TOW</b>	One 5-second blast followed by three 1-second blasts (each separated by 2-seconds) every 120 seconds. 	Vessel under tow (manned).

/// The audio frequency of the foghorn is selectable.  
 /// See page 52 for details.

☞ Continued on the next page.

## 7 OTHER FUNCTIONS

### ■ Automatic Foghorn function (Continued)

- ① While holding down [H/L], push [HAIL•RX] to activate the foghorn.

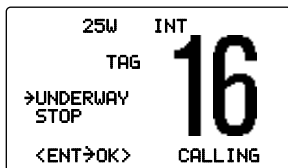

- ② Rotate [DIAL] to select the desired foghorn pattern, then push [DIAL•ENTER].
- 'UNDERWAY', 'STOP', 'SAIL', 'TOW' are selectable. (p. 51)
  - Even if [DIAL•ENTER] hasn't been pushed, the selected foghorn pattern is set, and the display automatically changes to the next step after 5 seconds of inactivity.

- ③ Rotate [DIAL] to adjust the foghorn level, then push [DIAL•ENTER].

- The foghorn level is adjustable in 31 steps.
- Even if [ENT] hasn't been pushed, the selected foghorn level is set, and the display automatically changes to the next step after 5 seconds of inactivity.

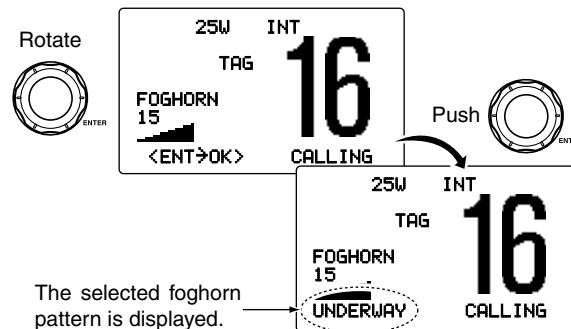

- ④ To return to normal operating mode, hold down [HAIL•RX] for 1 second.

/// When a DSC Call is received, the Automatic Foghorn function is automatically cancelled. The received call type is displayed on the LCD. (p. 35)

## ■ Set mode programming

Set mode is used to change the settings of the transceiver's functions: Scan type, Scan resume timer, Weather alert, Dual/Tri-watch, Beep tone, LCD contrast, Automatic foghorn frequency, Radio power\*<sup>1</sup>, Scrambler type\*<sup>2</sup>, Scrambler code\*<sup>2</sup> and Remote ID.

\*<sup>1</sup>Appears only when the optional Command microphone is connected.

\*<sup>2</sup>Appears only when the optional scrambler unit is installed.

/// Selectable functions may differ depending on dealer setting.

- ① Turn the power OFF, and while holding down [16•9], push [POWER] to enter the Set mode.
- ② After the display appears, release [16•9].
- ③ Rotate [DIAL] to select the desired item, then push [DIAL•ENTER].
- ④ Rotate [DIAL] to select the desired setting of the item, then push [DIAL•ENTER].
- ⑤ Push [CLR], or rotate [DIAL] to select "Exit," then push [DIAL•ENTER] to exit the Set mode.

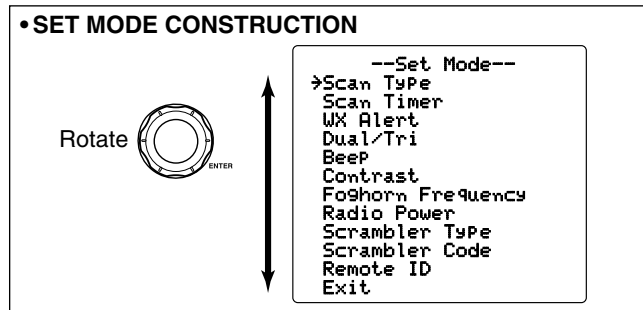

## ■ Set mode items

### ◇ Scan type

The transceiver has two scan types: Normal scan and Priority scan. Normal scan searches all TAG channels in the selected channel group. Priority scan sequentially searches all TAG channels while monitoring Channel 16.



(Default: Normal)

### ◇ Scan resume timer

The scan resume timer can be selected as a pause (OFF) or timer scan (ON). When OFF is selected, the scan pauses until the signal disappears. When ON is selected, the scan pauses 5 seconds and resumes, even if a signal has been received on any channel other than Channel 16.



(Default: OFF)

## 8 SET MODE

### ■ Set mode items (Continued)

#### ◇ Weather alert

A NOAA broadcast station transmits a weather alert tone before important weather information. When “ON” is selected, the previously selected (used) weather channel is checked any time during standby, or while scanning. When “ON with WX SCAN” is selected, the weather channels are sequentially checked during standby, or while scanning. “WX ALERT” blinks until the transceiver is operated after the transceiver detects the alert.

• “WX ALERT” appears instead of “WX” when the function is set ON.

```
--Set Mode--
WX Alert
ON
ON with WX SCAN
>OFF
```

(Default: OFF)

#### ◇ Dual/Tri-watch

This item can be selected as Dualwatch or Tri-watch. (p. 14)

```
--Set Mode--
Dual/Tri
Tri-watch
>Dualwatch
```

(Default: Dualwatch)

#### ◇ Beep tone

You can select silent operation by turning beep tones OFF, or you can have confirmation beeps sound at the push of a key by turning beep tones ON.

```
--Set Mode--
Beep
>ON
OFF
```

(Default: ON)

#### ◇ LCD contrast

This item adjusts the contrast of the LCD in 8 steps.

The level 1 is the lowest contrast, and the level 8 is the highest contrast.

```
--Set Mode--
Contrast
>5
4
3
2
1
<ENT>OK>
```

(Default: 5)

#### ◇ Automatic foghorn frequency

The audio frequency of the automatic foghorn can be adjusted to suit your preference. While this item is selected, holding down [PTT] sounds the foghorn— experiment with the selectable frequencies until you find one you like.

• The selectable frequency range is 200 Hz to 850Hz, in 50 Hz steps.

```
--Set Mode--
Foghorn Frequency
>400
350
300
250
200
<ENT>OK>
```

(Default: 400)

### ◇ Radio power

(Appears when an optional Command microphone is connected.)

This item sets the Radio Power function ON or OFF.

ON : The transceiver's power is controlled by the optional Command microphone. When the Command microphone is turned OFF, the transceiver is automatically turned OFF.

OFF : The transceiver's power is not controlled by the optional Command microphone. Even if the Command microphone is turned OFF, the transceiver will continue to work.

```

--Set Mode--
Radio Power
>ON
OFF
  
```

(Default: ON)

### ◇ Scrambler type

(Appears when a scrambler unit is installed.)

When an optional scrambler unit\* is installed, the scrambler type can be selected, depending on dealer setting.

\* The UT-98 is a discontinued model, and the current model is the UT-112.

```

--Set Mode--
Scrambler Type
UT-98
>UT-112
  
```

(Default: UT-112)

### ◇ Scrambler code

(Appears when a scrambler unit is installed.)

The scrambler code can be set depending on dealer setting.

32 codes (1 to 32) can be selected for UT-112. (Default: 1)

128 codes (0 to 127) can be selected for UT-98. (Default: 0)

```

--Set Mode--
Scrambler Code
5
4
3
2
1
>1
<ENT>OK>
  
```

(When UT-112 is installed)

```

--Set Mode--
Scrambler Code
4
3
2
1
>0
<ENT>OK>
  
```

(When UT-98 is installed)

### ◇ Remote ID

Set a Remote ID number to between 01 and 69.

The ID is included in the sentence of the format for the Icom original NMEA.

```

--Set Mode--
Remote ID
>13
12
11
10
09
<ENT>OK>
  
```

(Default: 13)

## ■ Connections

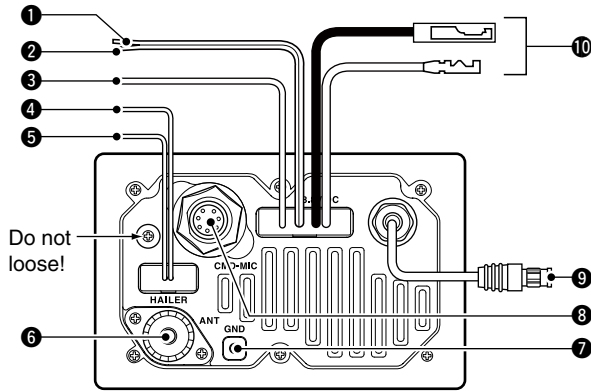

### 1 NMEA IN LEAD (Red)

Connects to a GPS receiver for position data.

- A NMEA0183 ver. 2.0 or 3.01 (sentence formatters RMC, GGA, GNS, GLL and VTG) compatible GPS receiver is required. Ask your dealer about suitable GPS receivers.

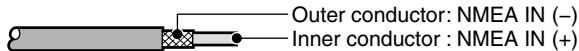

### 2 NMEA OUT LEAD (White)

Connects to a PC or navigation equipment (NMEA0183 ver. 3.01 sentence formatters DSC, DSE compatible) for position data received from other ships.

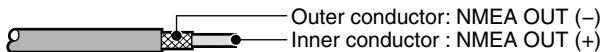

### 3 EXTERNAL SPEAKER LEAD (Yellow)

Connects to an external speaker.

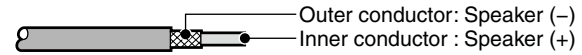

### 4 HAILER/FOGHORN (-) LEAD (Black)

Connects to a hailer speaker (25 W nominal at 13.8 V/ 4 Ω).

### 5 HAILER/FOGHORN (+) LEAD (Blue)

Connects to a hailer speaker (25 W nominal at 13.8 V/ 4 Ω).

### 6 ANTENNA CONNECTOR

Connects a marine VHF antenna with a PL-259 connector to the transceiver.

**CAUTION:** Transmitting without an antenna may damage the transceiver.

### 7 GROUND TERMINAL

Connect this terminal to a vessel ground to prevent electrical shocks and interference from other equipment occurring. Use a self-tapping screw (3 × 8 mm.)

### 8 EXTERNAL MICROPHONE JACK

Connect the optional Command microphone. (p. 62)

**9 MICROPHONE CONNECTOR** (p. 62)

Directly connects the supplied/optional microphone (HM-126)\*.

- If the connection cable is used for a longer distance remote operation, see page 62 for connection.

\*Not supplied with some versions.

**10 DC POWER CONNECTOR**

Connects the supplied DC power cable from this connector to an external 12 V battery.

**CAUTION:** After connecting the DC power cable, NMEA IN/OUT leads, external speaker lead and hailer/foghorn lead, cover the connector and leads with an adhesive tape as shown below, to prevent water seeping into the transceiver.

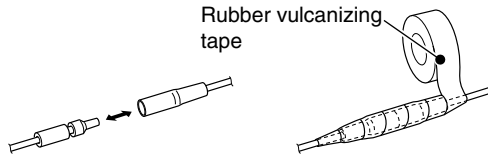

**◇ Connect to the MA-500TR**

Connect the transceiver to the MA-500TR CLASS B AIS TRANSPONDER using the OPC-2014\* NMEA CONNECTOR CABLE. After connecting, an Individual DSC call can be made to the AIS target using the transponder without entering the target's MMSI code.

\* The OPC-2014 is supplied with the MA-500TR

**• NMEA IN LEAD (Red)**

Inner conductor: NMEA IN (+)

Connects to lead 3 of the OPC-2014.

Outer conductor: NMEA IN (-)

Connects to lead 2 of the OPC-2014.

**• NMEA OUT LEAD (White)**

Inner conductor: NMEA OUT (+)

Connects to lead 5 of the OPC-2014.

Outer conductor: NMEA OUT (-)

Connects to lead 4 of the OPC-2014.

## 9 CONNECTIONS AND MAINTENANCE

### ■ Antenna

A key element in the performance of any communication system is the antenna. Ask your dealer about antennas and the best place to mount them.

### ■ Fuse replacement

One fuse is installed in the supplied DC power cable. If a fuse blows or the transceiver stops functioning, track down the source of the problem if possible, and replace the damaged fuse with a new one of the proper rating.

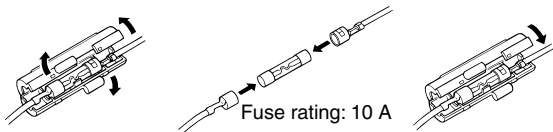

### ■ Cleaning

If the transceiver becomes dusty or dirty, wipe it clean with a soft, dry cloth.



**DO NOT** use harsh solvents such as benzine or alcohol, as they will damage transceiver surfaces.

### ■ Supplied accessories

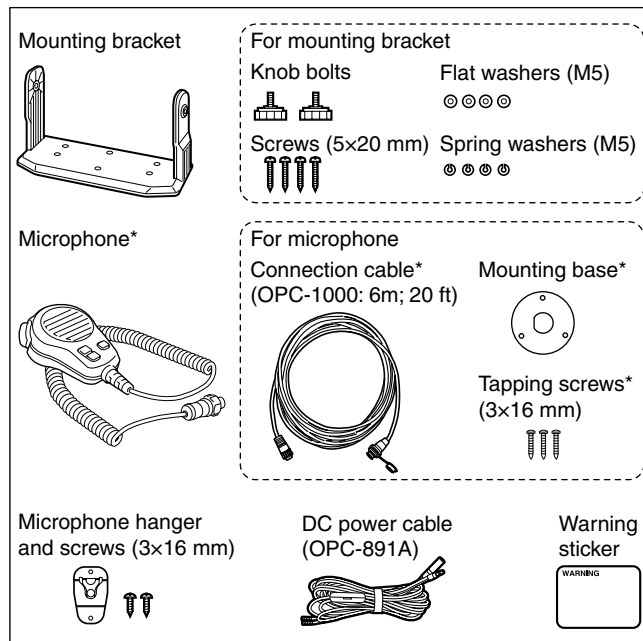

\* Not supplied with some versions.



## ■ Mounting the transceiver

### ◇ Using the supplied mounting bracket

The universal mounting bracket supplied with your transceiver allows overhead or dashboard mounting.

- ① Mount the bracket securely to a surface which is more than 10 mm (0.39 in) thick and can support more than 5 kg (11 lb) with the 4 supplied screws (5 × 20 mm).
- ② Attach the transceiver to the bracket so that the face of the transceiver is at 90° to your line of sight when operating it.

/// **KEEP** the transceiver and microphone at least 1 m (3.3 ft) away from the vessel's magnetic navigation compass.

/// **NOTE:** Check the installation angle; the function display may not be easy-to-read at some angles.

#### • OVERHEAD MOUNTING

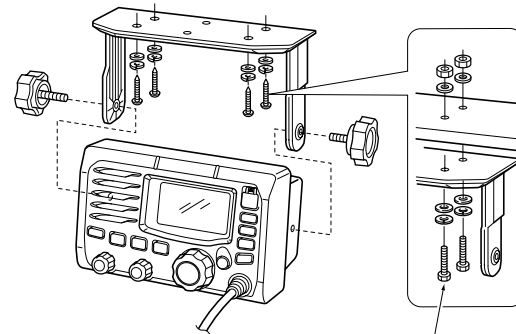

#### • MOUNTING ON THE BOARD

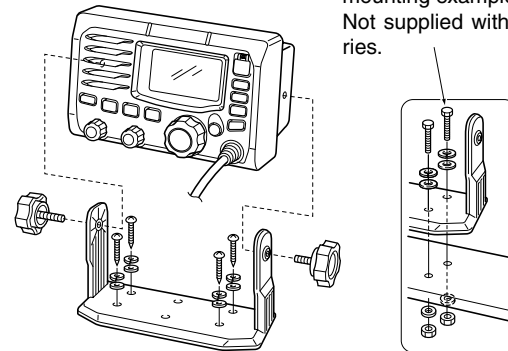

These bolts are shown a mounting example only. Not supplied with accessories.

### ■ MB-75 installation

An optional MB-75 FLUSH MOUNT KIT is available for mounting the transceiver to a flat surface such as an instrument panel.

/// **KEEP** the transceiver and microphone at least 1 m (3.3 ft) away from the vessel's magnetic navigation compass.

- ① Using the template on the last page, carefully cut a hole into the instrument panel (or wherever you plan to mount the transceiver).
- ② Slide the transceiver through the hole as shown below.

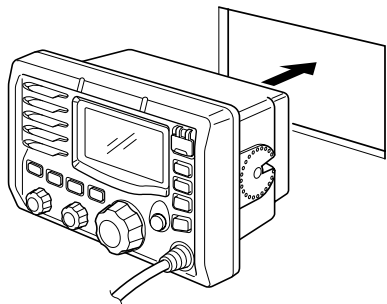

- ③ Attach the 2 supplied bolts (M5 × 8 mm) on either side of the IC-M504A.
- ④ Attach the clamps on either side of the IC-M504A.
  - Make sure that the clamps align parallel to the IC-M504A's body.

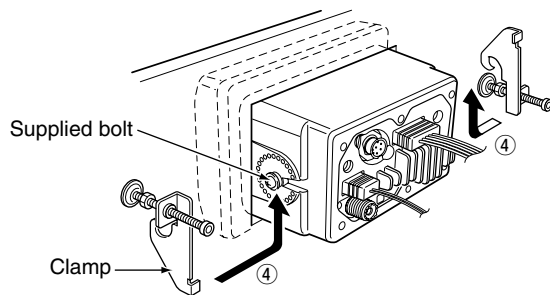

- ⑤ Tighten the end bolts on the clamps (rotate clockwise) so that the clamps press firmly against the inside of the instrument control panel. (Torque: 0.6 N•m)
- ⑥ Tighten the locking nuts (rotate counterclockwise) so that the IC-M504A is securely mounted in position as below.
- ⑦ Connect the antenna and power cable, then return the instrument control panel to its original place.

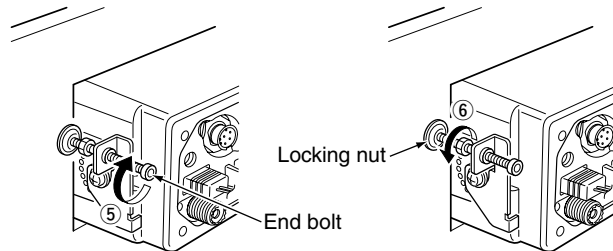

## ■ UT-112/UT-98\* installation

**⚠ WARNING! DISCONNECT** the DC power cable from the transceiver before performing any work on the transceiver. Otherwise, there is danger of electric shock and/or equipment damage.

Follow the case opening procedure shown here when you want to install an optional scrambler unit.

\* The UT-98 is the discontinued model, and the current model is the UT-112.

- ① Remove the 6 screws as shown below and open the transceiver.

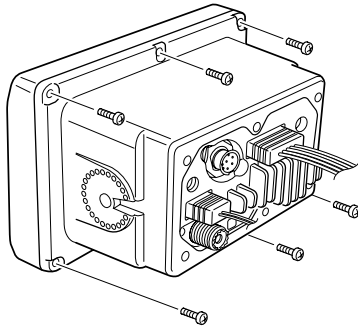

- ② Disconnect the flat cable and NMEA (4 pin) from J5 of the LOGIC unit.

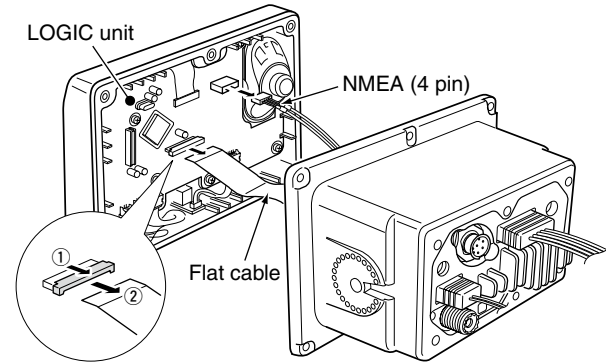

- ③ Install an optional scrambler unit to J3 on the AF unit as shown below.

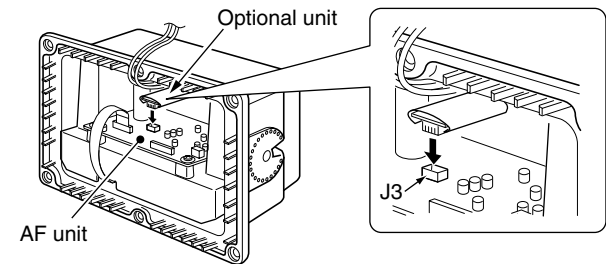

➤ Continued on the next page.

## 9 CONNECTIONS AND MAINTENANCE

### ■ UT-112/UT-98 installation (Continued)

- ④ Return the cables and screws to the original position.
- Be sure the flat cable is not installed upside down.

#### CAUTION:

- When re-assembling the case and tightening the screws, you must keep the specified torque ( $0.5 \pm 0.07 \text{ N}\cdot\text{m}$ ). Otherwise, the transceiver may be damaged (torque too high) or lose waterproof efficiency (torque too low).
- When uninstalling the optional unit, remove it vertically. Wiggling the unit from side to side may damage the connector.

### ■ Microphone installation

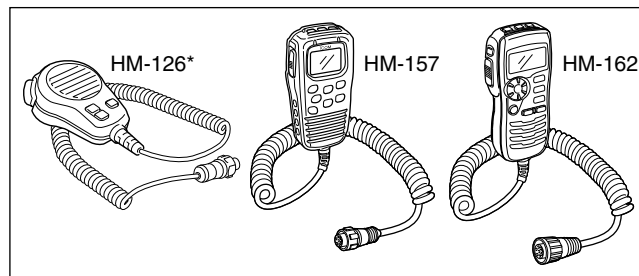

The supplied/optional HM-126\* and optional HM-157 can be connected to the transceiver directly, as well as using the long connection cable that comes with the microphone.

The connection cable is used for a longer distance remote operation, and the cable connector can be installed into a cabinet, wall, etc., as a built-in plug.

\* Not supplied with some versions.

/// The optional HM-162 should be attached to the transceiver using the connection cable that comes with the microphone.

**INFORMATION!**

For further long distance remote operation with the HM-157 or HM-162, the optional extension cable, OPC-999 or OPC-1541, is available. (6 m: 20 ft) Connect the extension cable between the transceiver and the connection cable. Up to two extension cables can be connected.

- OPC-999 : For the HM-157
- OPC-1541 : For the HM-162

Do not connect the HM-157 to the OPC-1541, or the HM-162 to the OPC-999.

**Microphone direct connection (for only HM-126/HM-157)**

- Insert the supplied/optional HM-126\* or optional HM-157 directly into the transceiver’s microphone connector (HM-126\*) or external microphone jack (HM-157), and tighten the cable nut.
  - The optional HM-162 cannot be directly connected to the transceiver. For the HM-162 connection, refer to “Microphone connection with the cable” as below.

**Microphone connection with the cable**

- ① Insert the HM-126’s supplied connection cable into the transceiver’s microphone connector, or the HM-157/162’s connection cable into the external microphone jack, and tighten the cable nut.

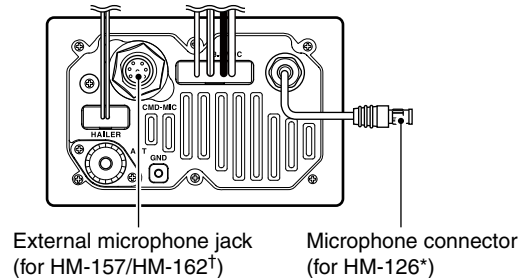

† For the HM-162 connection, use the connection cable.

\* HM-126 is not supplied with some versions.

Continued on the next page.

## 9 CONNECTIONS AND MAINTENANCE

### ■ Microphone installation (Continued)

- ② To use the connection cable as a wall socket, perform the following steps.
- ③ Using the mounting base as a template, carefully mark the holes where the cable and three screws will be fastened.
- ④ Drill holes at these marks.
- ⑤ Install the mounting base using the supplied screws as shown below.

#### • HM-126/HM-157

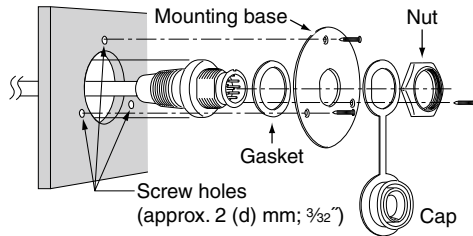

#### • HM-162

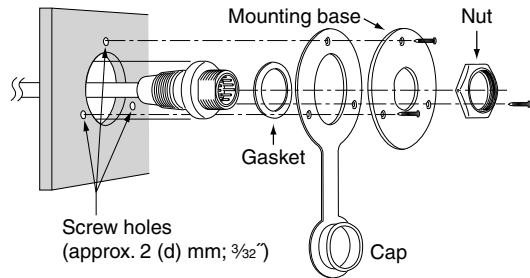

- ⑥ The completed installation should look like this.
- HM-126/HM-157
  - HM-162

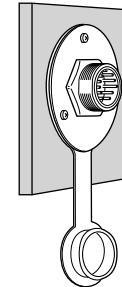
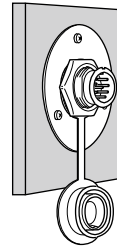

◇ HM-126/HM-157

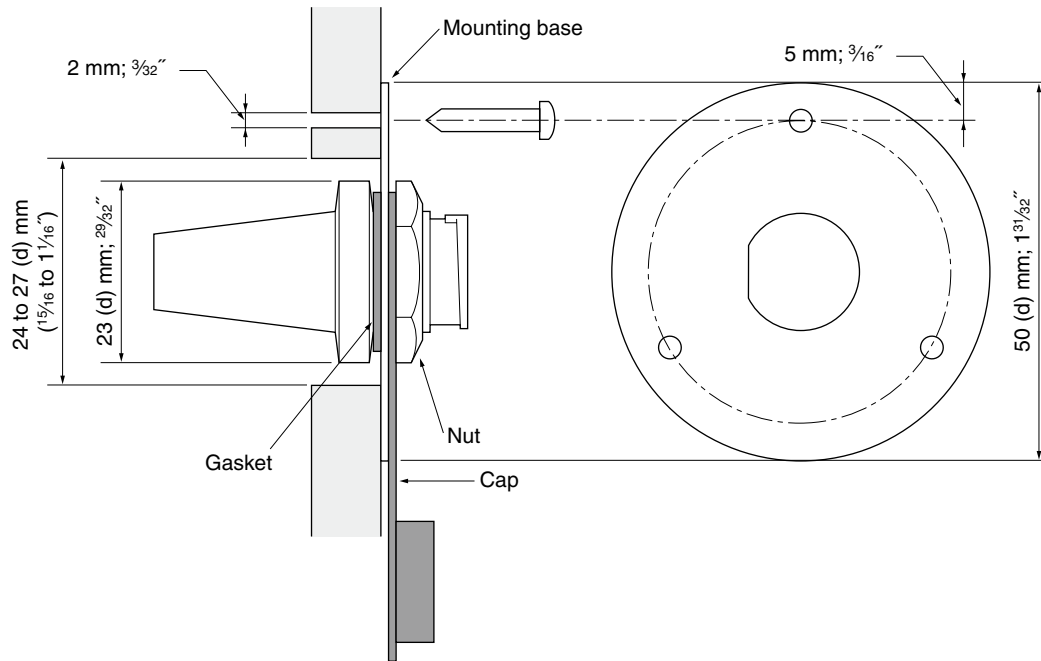

## 9 CONNECTIONS AND MAINTENANCE

### ◇ HM-162

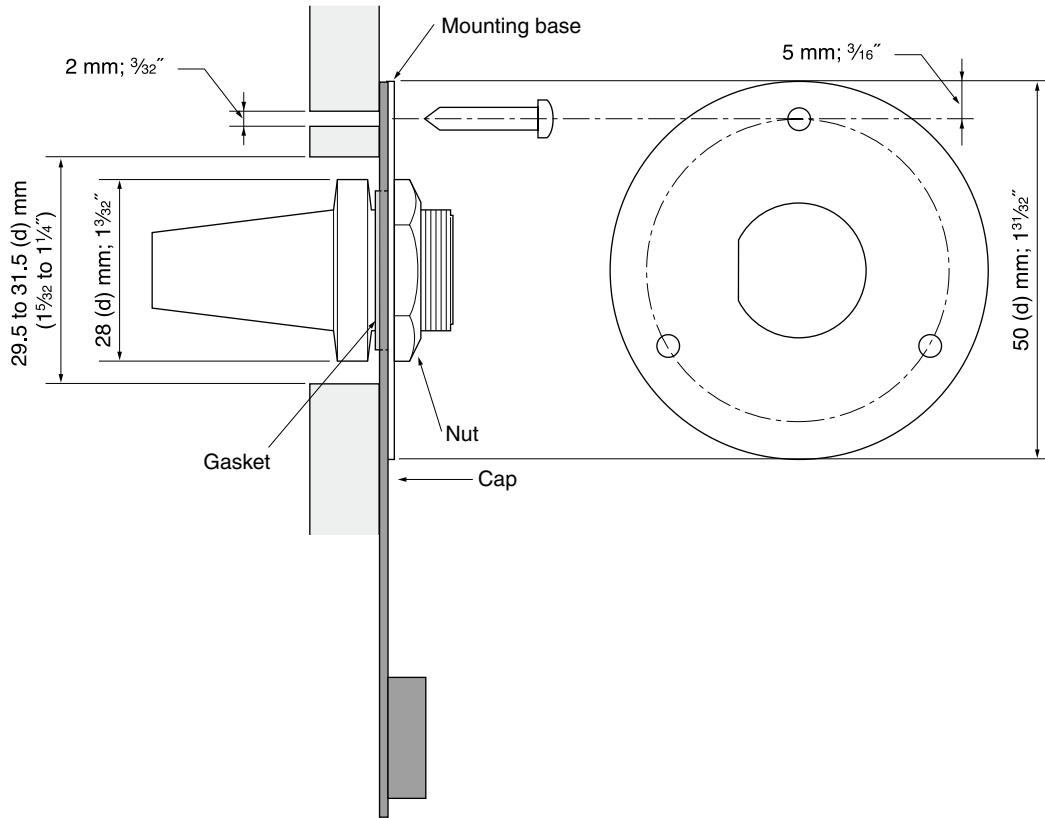



PROBLEM	POSSIBLE CAUSE	SOLUTION	REF.
The transceiver does not turn ON.	<ul style="list-style-type: none"> <li>• Bad connection to the power supply.</li> </ul>	<ul style="list-style-type: none"> <li>• Check the connection to the transceiver.</li> </ul>	p. 56
No sound comes from the speaker.	<ul style="list-style-type: none"> <li>• Squelch level is set too high.</li> <li>• Volume level is set too low.</li> <li>• Speaker has been exposed to water.</li> </ul>	<ul style="list-style-type: none"> <li>• Set [<b>SQL</b>] to the threshold point.</li> <li>• Set [<b>VOL</b>] to a suitable level.</li> <li>• Drain water from the speaker.</li> </ul>	<p>p. 8</p> <p>p. 8</p> <p>—</p>
Sensitivity is low.	<ul style="list-style-type: none"> <li>• The Attenuator is activated.</li> </ul>	<ul style="list-style-type: none"> <li>• Push [<b>LO/DX•IC•SCRM</b>] to turn the function OFF.</li> </ul>	
Transmitting is impossible, or high power cannot be selected.	<ul style="list-style-type: none"> <li>• Some channels are programmed for low power or receive only by regulations.</li> <li>• The output power is set to low.</li> </ul>	<ul style="list-style-type: none"> <li>• Change channels.</li> <li>• Push [<b>H/L</b>] to select high power.</li> </ul>	<p>pp. 6, 7, 70</p> <p>p. 8</p>
Scan does not start.	<ul style="list-style-type: none"> <li>• TAG channel is not programmed.</li> </ul>	<ul style="list-style-type: none"> <li>• Set the desired channels as TAG channels.</li> </ul>	p. 13
No beep sounds.	<ul style="list-style-type: none"> <li>• Beep tones are turned OFF.</li> </ul>	<ul style="list-style-type: none"> <li>• Turn the beep tone ON in Set mode.</li> </ul>	p. 54
Distress call cannot be transmitted.	<ul style="list-style-type: none"> <li>• MMSI (DSC self ID) code is not programmed.</li> </ul>	<ul style="list-style-type: none"> <li>• Program the MMSI (DSC self ID) code.</li> </ul>	p. 15

# 11 SPECIFICATIONS AND OPTIONS

## ■ Specifications

### ◇ General

- Frequency coverage : Tx 156.025–157.425 MHz  
Rx 156.050–163.275 MHz
- Mode : FM (16K0G3E), DSC (16K0G2B)
- Channel spacing : 25 kHz
- Current drain (at 13.8 V) : TX high 5.5 A max.  
Max. audio 1.5 A max.
- Power supply requirement : 13.8 V DC  $\pm$ 15%  
(negative ground)
- Frequency stability :  $\pm$ 10 ppm  
( $-20^{\circ}\text{C}$  to  $+60^{\circ}\text{C}$ ;  $-4^{\circ}\text{F}$  to  $+140^{\circ}\text{F}$ )
- Antenna impedance : 50  $\Omega$  nominal
- Dimensions : 165(W)  $\times$  110(H)  $\times$  123.2(D) mm  
(Projections not included) 6.5(W)  $\times$  4.33(H)  $\times$  4.85(D) inch
- Weight : Approximately 1450 g; 3 lb 3 oz

### ◇ Transmitter

- Output power : 25 W/1 W
- Modulation system : Variable reactance frequency modulation
- Max. frequency deviation :  $\pm$ 5.0 kHz
- Spurious emissions : Less than 70 dBc @ 25 W  
Less than 56 dBc @ 1 W

All stated specifications are subject to change without notice or obligation.

### ◇ Receiver

- Receive system : Double conversion superheterodyne
- Sensitivity (12 dB SINAD) : 0.22  $\mu\text{V}$  (typical)
- Squelch sensitivity : Less than 0.32  $\mu\text{V}$
- Intermodulation rejection ratio : 80 dB (typical)
- Spurious response rejection ratio : 80 dB (typical)
- Adjacent channel selectivity : 80 dB (typical)
- Audio output power : 4.5 W (typical) at 10% distortion with a 4  $\Omega$  load

### ◇ Dimensions

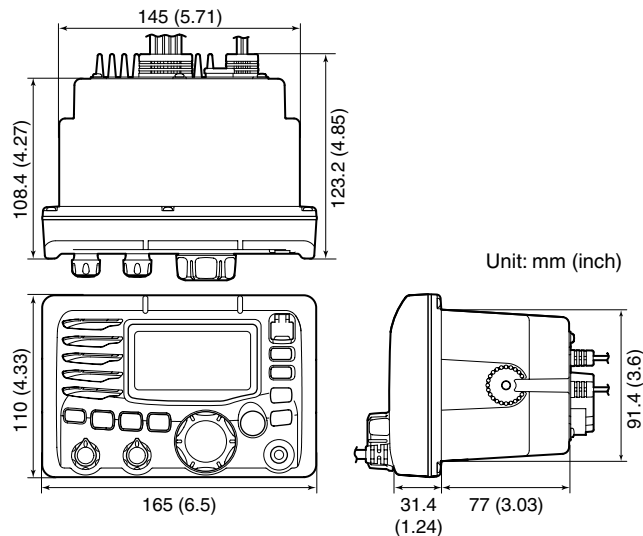

## ■ Options

- **MB-75** FLUSH MOUNT KIT  
For mounting the transceiver to a panel.
- **HM-157** COMMANDMICII™  
External microphone-type controller. Provides optional intercom operation. 6 m (20 feet) microphone cable and mounting base included. Black and white colors are available.  
Do not connect the HM-157 to the OPC-1541.
- **HM-162** COMMANDMICIII™  
External microphone-type controller. Provides optional intercom operation. 6 m (20 feet) microphone cable and mounting base included. Black and white colors are available.  
Do not connect the HM-162 to the OPC-999.
- **HM-126** HAND MICROPHONE  
Equipped with [▲]/[▼] (channel up/down,) [HI/LO] and [PTT] keys, a speaker and microphone.
- **OPC-999** MICROPHONE EXTENSION CABLE  
6 m (20 feet) microphone extension cable for optional HM-157 COMMANDMICII™. Up to 2 OPC-999 can be connected. (18 m; 60 feet maximum)
- **OPC-1541** MICROPHONE EXTENSION CABLE  
6 m (20 feet) microphone extension cable for optional HM-162 COMMANDMICIII™. Up to 2 OPC-1541 can be connected. (18 m; 60 feet maximum)
- **OPC-1000** MICROPHONE CONNECTION CABLE  
6 m (20 feet) microphone connection cable for the supplied microphone (HM-126).
- **UT-112** VOICE SCRAMBLER UNIT  
Ensures private communications. 32 codes are available.  
Not available in some countries.

Approved Icom optional equipment is designed for optimal performance when used with an Icom transceiver. Icom is not responsible for the destruction or damage to an Icom transceiver in the event the Icom transceiver is used with equipment that is not manufactured or approved by Icom.



# TEMPLATE 13

Cut here

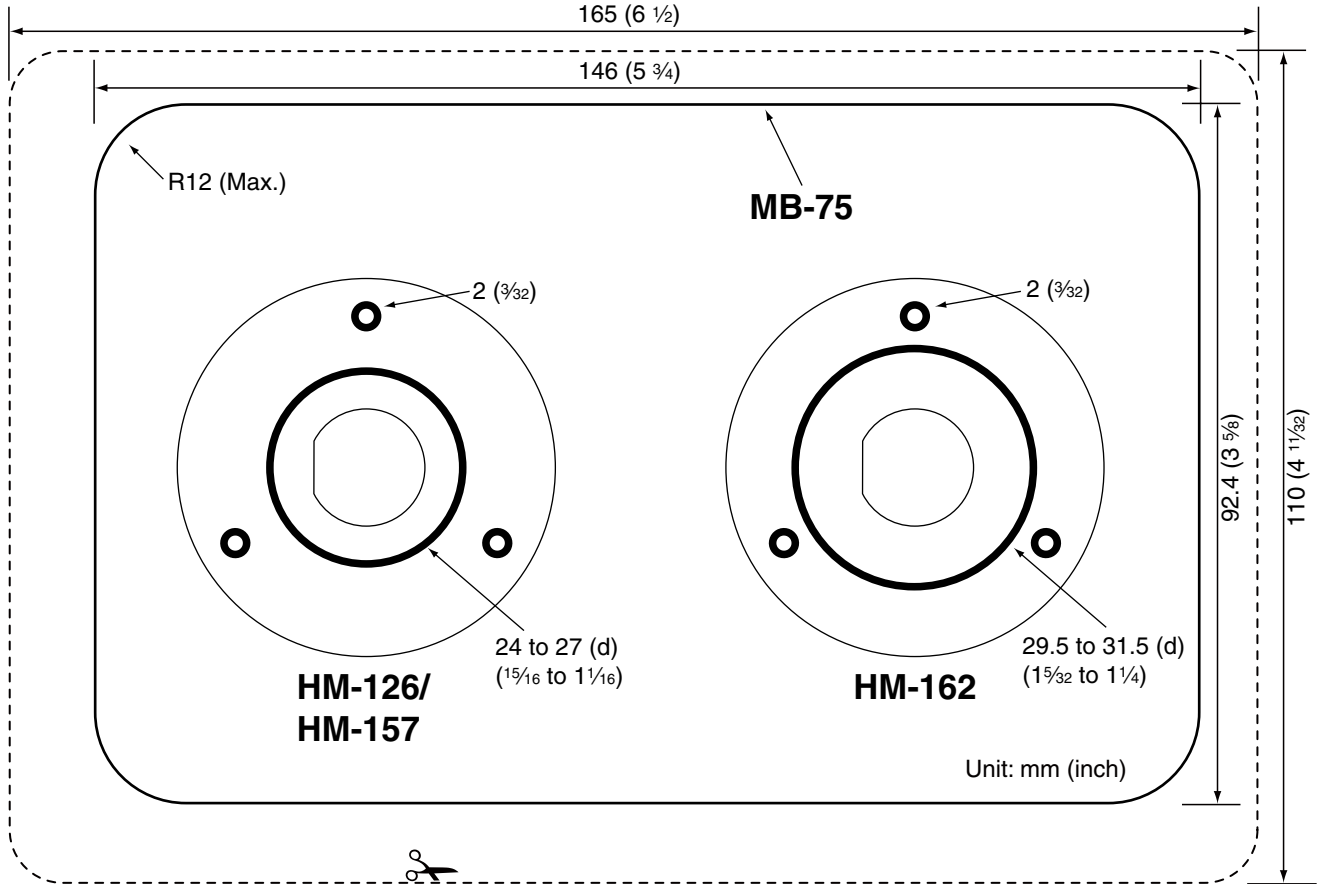

12  
13



**• FOR CLASS B UNINTENTIONAL RADIATORS:**

This equipment has been tested and found to comply with the limits for a Class B digital device, pursuant to part 15 of the FCC Rules. These limits are designed to provide reasonable protection against harmful interference in a residential installation. This equipment generates, uses and can radiate radio frequency energy and, if not installed and used in accordance with the instructions, may cause harmful interference to radio communications. However, there is no guarantee that interference will not occur in a particular installation. If this equipment does cause harmful interference to radio or television reception, which can be determined by turning the equipment off and on, the user is encouraged to try to correct the interference by one or more of the following measures:

- Reorient or relocate the receiving antenna.
- Increase the separation between the equipment and receiver.
- Connect the equipment into an outlet on a circuit different from that to which the receiver is connected.
- Consult the dealer or an experienced radio/TV technician for help.

**Count on us!**

A-6932D-1US  
Printed in Japan  
© 2011 Icom Inc.

Printed on recycled paper with soy ink.

**Icom Inc.**

1-1-32 Kamiminami, Hirano-ku, Osaka 547-0003, Japan