



INSTRUCTION MANUAL

VHF MARINE TRANSCEIVER IC-M412



Icom Inc.

FOREWORD

Thank you for purchasing this Icom product. The IC-M412 VHF MARINE TRANSCEIVER is designed and built with Icom's state of the art technology and craftsmanship. With proper care, this transceiver should provide you with years of trouble-free operation.

We appreciate you making the IC-M412 your radio of choice, and hope you agree with Icom's philosophy of "technology first." Many hours of research and development went into the design of your IC-M412.

◇ **FEATURES**

- *Advanced receiver performance*
- *Easy to hear speaker*
- *Built-in DSC meets Class D requirement*
- *Rugged waterproof construction*
- *Favorite channel function*
- *AquaQuake water draining function*
- *Easy to make individual DSC calls using Icom's MA-500TR Class B AIS Transponder*

Icom, Icom Inc. and the Icom logo are registered trademarks of Icom Incorporated (Japan) in Japan, the United States, the United Kingdom, Germany, France, Spain, Russia and/or other countries.

IMPORTANT

READ ALL INSTRUCTIONS carefully and completely before using the transceiver.

SAVE THIS INSTRUCTION MANUAL — This instruction manual contains important operating instructions for the IC-M412.

EXPLICIT DEFINITIONS

WORD	DEFINITION
⚠ WARNING!	Personal injury, fire hazard or electric shock may occur.
CAUTION	Equipment damage may occur.
NOTE	Recommended for optimum use. No risk of personal injury, fire or electric shock.

CLEAN THE TRANSCEIVER AND MICROPHONE THOROUGHLY WITH FRESH WATER after exposure to water including salt water, otherwise, the keys and switches may become inoperable due to salt crystallization.

IN CASE OF EMERGENCY

If your vessel requires assistance, contact other vessels and the Coast Guard by sending a Distress call on Channel 16.

USING CHANNEL 16 **DISTRESS CALL PROCEDURE**

1. "MAYDAY MAYDAY MAYDAY."
2. "THIS IS" (name of vessel)
3. Your call sign or other indication of the vessel (AND 9-digit DSC ID if you have one).
4. "LOCATED AT" (your position)
5. The nature of the distress and assistance required.
6. Any other information which might facilitate the rescue.

Or, transmit your Distress call using digital selective calling on Channel 70.

USING DIGITAL SELECTIVE CALLING (DSC) ***(Channel 70)*** **DISTRESS CALL PROCEDURE**

1. While lifting up the key cover, hold down [**DISTRESS**] for 3 seconds until you hear 3 short beeps change to one long beep.
2. Wait for an acknowledgment on Channel 70 from a coast station.
 - After the acknowledgement is received, Channel 16 is automatically selected.
3. Hold down [**PTT**], then transmit the appropriate information as listed above.

FCC INFORMATION

• FOR CLASS B UNINTENTIONAL RADIATORS:

This equipment has been tested and found to comply with the limits for a Class B digital device, pursuant to part 15 of the FCC Rules. These limits are designed to provide reasonable protection against harmful interference in a residential installation. This equipment generates, uses and can radiate radio frequency energy and, if not installed and used in accordance with the instructions, may cause harmful interference to radio communications. However, there is no guarantee that interference will not occur in a particular installation. If this equipment does cause harmful interference to radio or television reception, which can be determined by turning the equipment off and on, the user is encouraged to try to correct the interference by one or more of the following measures:

- Reorient or relocate the receiving antenna.
- Increase the separation between the equipment and receiver.
- Connect the equipment into an outlet on a circuit different from that to which the receiver is connected.
- Consult the dealer or an experienced radio/TV technician for help.

CAUTION: Changes or modifications to this device, not expressly approved by Icom Inc., could void your authority to operate this device under FCC regulations.

SUPPLIED ACCESSORIES

The following accessories are supplied;

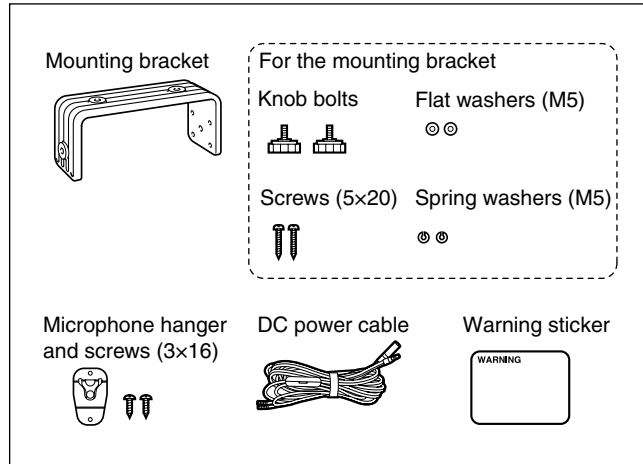

NOTE

A WARNING STICKER is supplied with the transceiver. To comply with FCC regulations, this sticker must be affixed in such a location as to be readily seen from the operating controls of the radio as in the diagram below. Make sure the chosen location is clean and dry before applying the sticker.

EXAMPLE

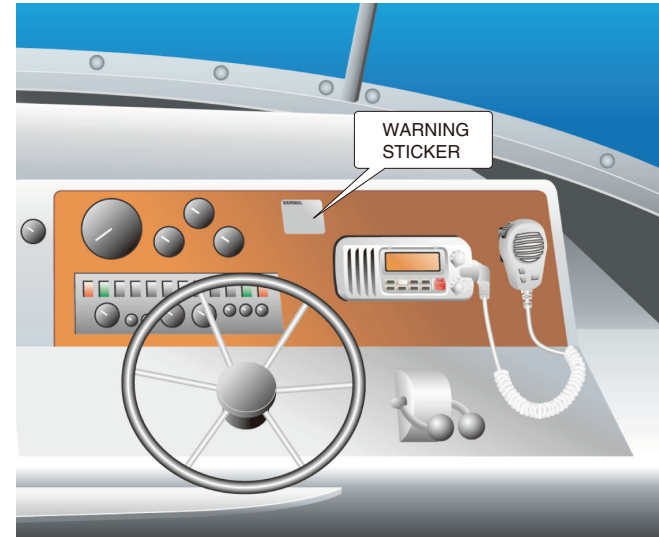

RADIO OPERATOR WARNING



Icom requires the radio operator to meet the FCC Requirements for Radio Frequency Exposure. An omnidirectional antenna with gain not greater than 9 dBi must be mounted a minimum of 5 meters (measured from the lowest point of the antenna) vertically above

the main deck and all possible personnel. This is the minimum safe separation distance estimated to meet all RF exposure compliance requirements. This 5 meter distance is based on the FCC Safe Maximum Permissible Exposure (MPE) distance of 3 meters added to the height of an adult (2 meters) and is appropriate for all vessels.

For watercraft without suitable structures, the antenna must be mounted so as to maintain a minimum of 1 meter vertically between the antenna, (measured from the lowest point of the antenna), to the heads of all persons AND all persons must stay outside of the 3 meter MPE radius.

Do not transmit with radio and antenna when persons are within the MPE radius of the antenna, unless such persons (such as driver or radio operator) are shielded from antenna field by a grounded metallic barrier. The MPE Radius is the minimum distance from the antenna axis that person should maintain in order to avoid RF exposure higher than the allowable MPE level set by FCC.

FAILURE TO OBSERVE THESE LIMITS MAY ALLOW THOSE WITHIN THE MPE RADIUS TO EXPERIENCE RF RADIATION ABSORPTION WHICH EXCEEDS THE FCC MAXIMUM PERMISSIBLE EXPOSURE (MPE) LIMIT. IT IS THE RESPONSIBILITY OF THE RADIO OPERATOR TO ENSURE THAT THE MAXIMUM PERMISSIBLE EXPOSURE LIMITS ARE OBSERVED AT ALL TIMES DURING RADIO TRANSMISSION. THE RADIO OPERATOR IS TO ENSURE THAT NO BYSTANDERS COME WITHIN THE RADIUS OF THE MAXIMUM PERMISSIBLE EXPOSURE LIMITS.

Determining MPE Radius

THE MAXIMUM PERMISSIBLE EXPOSURE (MPE) RADIUS HAS BEEN ESTIMATED TO BE A RADIUS OF ABOUT 3M PER OET BULLETIN 65 OF THE FCC. THIS ESTIMATE IS MADE ASSUMING THE MAXIMUM POWER OF THE RADIO AND ANTENNAS WITH A MAXIMUM GAIN OF 9dBi ARE USED FOR A SHIP MOUNTED SYSTEM.

TABLE OF CONTENTS

FOREWORD	i	6 DSC OPERATION	13–43
IMPORTANT	i	■ MMSI code programming	13
EXPLICIT DEFINITIONS	i	■ DSC address ID	14
IN CASE OF EMERGENCY	ii	■ Position and time programming	17
FCC INFORMATION	iii	■ Position indication	18
SUPPLIED ACCESSORIES	iv	■ Distress call	18
NOTE	iv	■ Transmitting DSC calls	21
RADIO OPERATOR WARNING	v	■ Receiving DSC calls	34
TABLE OF CONTENTS	vi	■ Received messages	41
PRECAUTIONS	vii	■ Automatic acknowledgement	43
1 OPERATING RULES	1	■ Offset time	43
2 PANEL DESCRIPTION	2–4	7 SET MODE	44–47
■ Front panel	2	■ Set mode programming	44
■ Microphone	3	■ Set mode items	45
■ Function display	4	8 CONNECTIONS AND MAINTENANCE	48–51
3 BASIC OPERATION	5–9	■ Connections	48
■ Channel selection	5	■ Antenna	49
■ Receiving and transmitting	7	■ Fuse replacement	49
■ Call channel programming	8	■ Cleaning	49
■ Channel comments	8	■ Mounting the transceiver	50
■ Microphone Lock function	9	■ Optional MB-69 installation	51
■ Display backlight	9	9 TROUBLESHOOTING	52
■ AquaQuake water draining function	9	10 SPECIFICATIONS AND OPTION	53–55
4 SCAN OPERATION	10–11	■ Specifications	53
■ Scan types	10	■ Option	55
■ Setting TAG channels	11	11 CHANNEL LIST	56
■ Starting a scan	11	12 TEMPLATE	57
5 DUALWATCH/TRI-WATCH	12		
■ Description	12		
■ Operation	12		

PRECAUTIONS

⚠ **WARNING! NEVER** connect the transceiver to an AC outlet. This may pose a fire hazard or result in an electric shock.

⚠ **WARNING! NEVER** connect the transceiver to a power source of more than 16 V DC or use reverse polarity. This will could cause a fire the transceiver.

⚠ **WARNING! NEVER** cut the DC power cable between the DC plug at the back of the transceiver and fuse holder. If an incorrect connection is made after cutting, the transceiver may be damaged.

CAUTION: NEVER place the transceiver where normal operation of the vessel may be hindered or where it could cause bodily injury.

KEEP the transceiver and microphone at least 1 meter (3.3 feet) away from your vessel's magnetic navigation compass.

DO NOT use or place the transceiver in areas with temperatures below -20°C (-4°F) or above $+60^{\circ}\text{C}$ ($+140^{\circ}\text{F}$), or in areas subject to direct sunlight, such as the dashboard.

DO NOT use harsh solvents such as benzine or alcohol to clean the transceiver, as they will damage the transceiver's surfaces. If the transceiver becomes dusty or dirty, wipe it clean with a soft, dry cloth.

BE CAREFUL! The transceiver rear panel will become hot when operating continuously for long periods of time. Place the transceiver in a secure place to avoid inadvertent use by children

BE CAREFUL! The transceiver meets IPX7* requirements for waterproof protection. However, once the transceiver has been dropped, waterproof protection cannot be guaranteed because of possible damage to the transceiver's case or the waterproof seal.

* Except for the DC power and other cables.

◇ PRIORITIES

- Read all rules and regulations pertaining to priorities and keep an up-to-date copy handy. Safety and Distress calls take priority over all others.
- You must monitor Channel 16 when you are not operating on another channel.
- False or fraudulent distress signals are prohibited and punishable by law.

◇ PRIVACY

- Information overheard but not intended for you cannot lawfully be used in any way.
- Indecent or profane language is prohibited.

◇ RADIO LICENSES

(1) SHIP STATION LICENSE

You must have a current radio station license before using the transceiver. It is unlawful to operate a ship station which is not licensed.

Inquire through your dealer or the appropriate government agency for a Ship-Radiotelephone license application. This government-issued license states the call sign which is your craft's identification for radio purposes.

(2) OPERATOR'S LICENSE

A Restricted Radiotelephone Operator Permit is the license most often held by small vessel radio operators when a radio is not required for safety purposes.

The Restricted Radiotelephone Operator Permit must be posted or kept with the operator. Only a licensed radio operator may operate a transceiver.

However, non-licensed individuals may talk over a transceiver if a licensed operator starts, supervises, ends the call and makes the necessary log entries.

Keep a copy of the current government rules and regulations handy.

Radio license for boaters (U.S.A. only)

The Telecommunications Act of 1996 permits recreational boaters to have and use a VHF marine radio, EPIRB, and marine radar without having an FCC ship station license. Boaters traveling on international voyages, having an HF single sideband radiotelephone or marine satellite terminal, or required to carry a marine radio under any other regulation must still carry an FCC ship station license. For further information, see the FCC Ship Radio Stations Fact Sheet.

■ Front panel

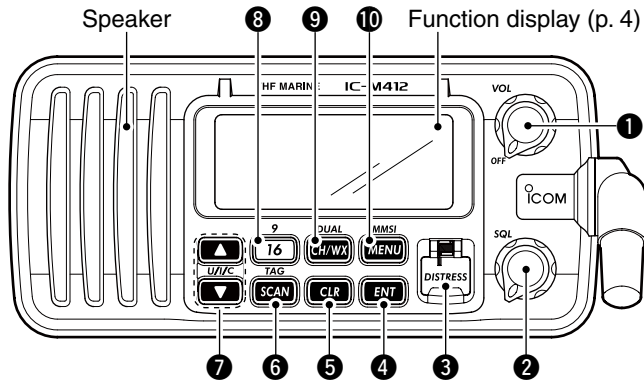

1 POWER • VOLUME CONTROL [VOL]

- ➔ Rotate to turn the transceiver power ON or OFF.
- ➔ Rotate to adjust the audio level.

2 SQUELCH CONTROL [SQL] (p. 7)

Rotate to set the squelch threshold level.

3 DISTRESS KEY [DISTRESS] (p. 18)

Hold down for 3 seconds to transmit a Distress call.

4 ENTER KEY [ENT]

Push to set the DSC menu, a channel comment, etc.

5 CLEAR KEY [CLR]

Push to cancel the entered function, or exit the DSC menu.

6 SCAN • TAG CHANNEL KEY

[SCAN] • [TAG](SCAN) (p. 11)

- ➔ Push to start and stop the Normal or Priority scan.
- ➔ Hold down for 1 second to set or clear the displayed channel as a tag (scanned) channel.
- ➔ While holding down [HI/LO] on the microphone, hold down this key for 3 seconds to set or clear all tag channels in the selected channel group.

7 CHANNEL UP/DOWN • CHANNEL GROUP KEYS

[▲]/[▼] • [U/I/C]

- ➔ Push to select the operating channels, Set mode settings, DSC menu items, etc. (pp. 5, 6, 13, 44)
- ➔ Hold down [▲] to continuously select higher channels.
- ➔ Hold down [▼] to continuously select lower channels
- ➔ Push both keys to sequentially select the USA, International or Canadian channel groups. (p. 6)
- ➔ While holding down [SCAN], push [▲] or [▼] to adjust the brightness of the LCD and key backlight. (p. 9)
- ➔ While holding down both keys, turn ON the power to activates the AquaQuake function. (p. 9)
- ➔ During scan operation, checks TAG channels, changes scanning direction or manually resumes the scan. (p. 11)

- 8 CHANNEL 16/CALL CHANNEL KEY [16] • [9](16)**

 - ➔ Push to select Channel 16. (p. 5)
 - ➔ Hold down for 1 second to select the Call channel. (p. 5)
 - “CALL” appears when the Call channel is selected.
 - ➔ When the Call channel is selected, hold down for 3 seconds to enter the Call channel programming mode. (p. 8)
 - ➔ While holding down [CH/WX], push to enter the channel comment programming mode. (p. 8)
 - ➔ While in the channel comment programming mode, push to move the cursor backward. (p. 8)
 - ➔ While holding down this key, turn ON the power to enter the Set mode. (p. 44)

- 9 CHANNEL/WEATHER CHANNEL KEY /DUALWATCH/ TRI-WATCH KEY [CH/WX] • [DUAL](CH/WX)**

 - ➔ When pushed, selects and toggles the regular channel and Weather channel. (pp. 5, 6)
 - ➔ Hold down for 1 second to start Dualwatch or Tri-watch. (p. 12)
 - Push to stop Dualwatch or Tri-watch when either is activated.
 - ➔ While in the channel comment programming mode, push to move the cursor forward. (p. 8)

- 10 DSC MENU KEY [MENU] • [MMSI](MENU) (p. 13)**

 - ➔ Push to turn the DSC menu ON or OFF.
 - ➔ Hold down for 1 second to display the MMSI code on the channel comment display.

Microphone

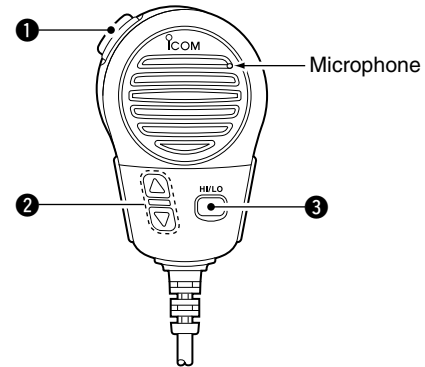

- 1 PTT SWITCH [PTT]**

 - ➔ Hold down to transmit; release to receive. (p. 7)

- 2 CHANNEL UP/DOWN KEYS [▲]/[▼]**

 - ➔ Push to select the operating channels, Set mode settings, DSC menu items, etc. (pp. 5, 6, 13, 44)
 - ➔ While scanning, checks TAG channels, changes scanning direction or manually resumes the scan. (p. 11)

- 3 TRANSMIT POWER KEY [HI/LO]**

 - ➔ Push to select the output power high or low. (p. 7)
 - Some channels are set to low power only.
 - ➔ While holding down this key, turn ON the power to toggle the Microphone Lock function ON or OFF. (p. 9)

2 PANEL DESCRIPTION

■ Function display

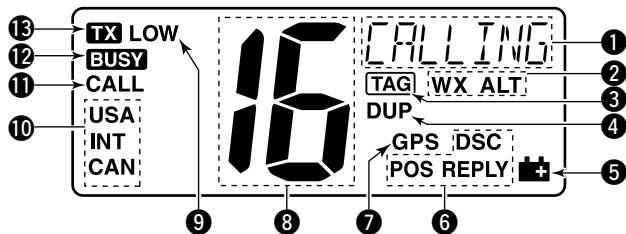

1 CHANNEL COMMENT DISPLAY

- ➔ A channel comment appears and scrolls for about 10 seconds after the channel is selected, if programmed. (p. 8)
- ➔ “SCAN 16” appears during Priority scan; “SCAN” appears during Normal scan. (p. 11)
- ➔ “DW 16” appears during Dualwatch; “TW 16” appears during Tri-watch. (p. 12)
- ➔ In the Set mode, displays and scrolls the selected item. (p. 44)

2 WEATHER CHANNEL ICONS (pp. 6, 45)

- ➔ “WX” appears when a weather channel is selected.
- ➔ “WX ALT” appears when the Weather Alert function is in use; blinks when an alert tone is received.

3 TAG CHANNEL ICON (p. 11)

- Appears when a TAG channel is selected.

4 DUPLEX ICON (p. 6)

- Appears when a duplex channel is selected.

5 LOW BATTERY ICON

- Appears when the battery voltage drops to approximately 10 V DC or below.

6 DSC ICONS

Indicates the DSC status.

- “DSC” appears when a DSC call is received. (pp. 23, 34)
- “POS REPLY” appears when a Position Reply call is received. (p. 38)

7 GPS ICON

- ➔ Appears while valid position data is received.
- ➔ Blinks when invalid position data is received.
- ➔ Disappears when no GPS receiver is connected.

8 CHANNEL NUMBER READOUT

- ➔ Indicates the selected operating channel number.
 - “A” appears when a simplex channel is selected.
- ➔ In the Set mode, displays the selected option. (p. 44)

9 LOW POWER ICON (p. 7)

- Appears when low power is selected.

10 CHANNEL GROUP ICON (p. 6)

- Indicates whether a U.S.A. “USA,” International “INT” or Canadian “CAN” channel group is selected.

11 CALL CHANNEL ICON (p. 5)

- Appears when the Call channel is selected.

12 BUSY ICON (p. 7)

- Appears when receiving a signal or when the squelch opens.

13 TRANSMIT ICON (p. 7)

- Appears while transmitting.

■ Channel selection

◇ Channel 16

Channel 16 is the distress and safety channel. It is used for establishing initial contact with a station and for emergency communications. Channel 16 is monitored during both Dual-watch and Tri-watch. While in the stand-by mode, you must monitor Channel 16.

- Push [16] to select Channel 16.
- Push [CH/WX] to return to the previous display, or push [▲] or [▼] to select a different channel.



Convenient!

When the Favorite channel function is turned ON (p. 47), push the [▲]/[▼] keys on the microphone to sequentially select the favorite channels in the selected channel group.

- The Favorite channels are set by the TAG channel setting. (p. 11)

◇ Channel 9 (Call channel)

Each regular channel group has a separate leisure-use Call channel. The Call channel is monitored during Tri-watch. The Call channels can be programmed (p. 8) and are used to store your most often used channel in each channel group for quick recall.

- Hold down [9](16) for 1 second to select the Call channel of the selected channel group.
 - “CALL” and the Call channel number appear.
 - Each channel group may have an independent Call channel after programming a Call channel. (p. 8)
- Push [CH/WX] to return to the previous display, or push [▲] or [▼] to select a different channel.

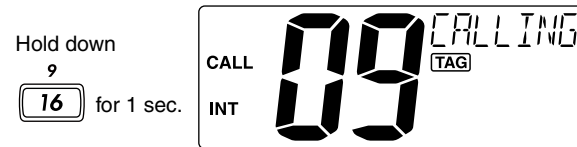

3 BASIC OPERATION

■ Channel selection (Continued)

◇ U.S.A., international and Canadian channels

The transceiver is pre-programmed with 57 USA, 57 international and 61 Canadian channels. These channel groups may be specified for the operating area.

- ① Push **[CH/WX]** to select a regular channel.
 - If a weather channel appears, push **[CH/WX]** again.
- ② Push **[U/I/C]** (both **[▲]** and **[▼]**) to change the channel group.
 - USA, International and Canadian channel groups can be selected in sequence.

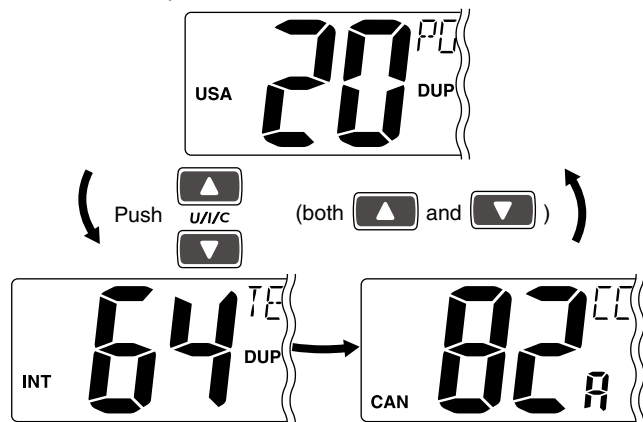

- ③ Push **[▲]** or **[▼]** to select a channel.
 - “DUP” appears for duplex channels.
 - “A” appears when a simplex channel is selected.

◇ Weather channels

(U.S.A. version transceiver only)

The transceiver has 10 weather channels. These are used for monitoring broadcasts from NOAA (National Oceanic and Atmospheric Administration.)

The transceiver can detect a weather alert tone on the selected weather channel or while scanning. (p. 11)

- ① Push **[CH/WX]** once or twice to select a weather channel.
 - “WX” appears when a weather channel is selected.
 - “WX ALT” appears when the Weather Alert function is in use. (p. 45)

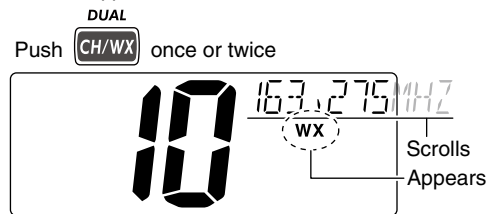

When the Weather alert is OFF.

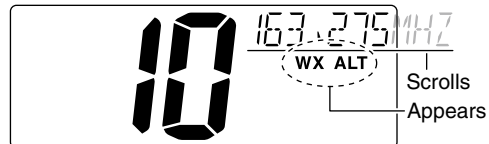

When the Weather alert is ON.

- ② Push **[▲]** or **[▼]** to select a channel.

■ Receiving and transmitting

CAUTION: Transmitting without an antenna may damage the transceiver.

- ① Rotate **[VOL]** to turn ON the power.
- ② Set the audio and squelch levels.
 - ➔ Rotate **[SQL]** fully counterclockwise.
 - ➔ Rotate **[VOL]** to adjust the audio output level.
 - ➔ Rotate **[SQL]** clockwise until the noise just disappears.

While in the DSC operation, please make sure you correctly set the squelch.
- ③ Push **[U/I/C]** (both **[▲]** and **[▼]**) to change the channel group. (p. 6)
- ④ Push **[▲]** or **[▼]** to select a desired channel. (pp. 5, 6)
 - When receiving a signal, “**BUSY**” appears and audio is heard from the speaker.
 - Further adjustment of **[VOL]** may be necessary.
- ⑤ Push **[HI/LO]** on the microphone to select the output power, if necessary.
 - “**LOW**” appears when low power is selected.
 - Choose low power for short range communications, choose high power for longer distance communications.
 - Some channels are for low power only.
- ⑥ Hold down **[PTT]** to transmit, then speak into the microphone (*).
- “**TX**” appears.
- Channel 70 cannot be used for transmission other than DSC.
- ⑦ Release **[PTT]** to receive.

IMPORTANT: To maximize the readability of your transmitted signal, pause a few seconds after holding down **[PTT]**, hold the microphone 5 to 10 cm from your mouth and speak into the microphone (*) at a normal voice level.

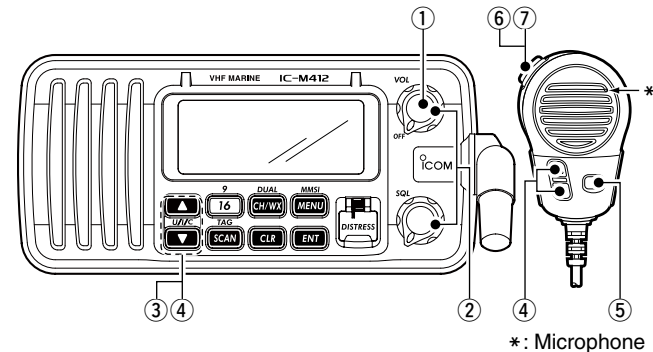

✓ NOTE for the TOT (Time-out Timer) function

The TOT function inhibits continuous transmission over a pre-programmed time period after the transmission starts. A beep sounds and “TOT” appears on the channel comment display at the 10 seconds before the transmission will be shut down by the TOT function. Transmission is disabled for 10 seconds after this transmission shut down.

3 BASIC OPERATION

■ Call channel programming

The Call channel is used to select Channel 9 (default). However, you can program the Call channel in each channel group with an often-used channel, for quick recall.

- ① Push **[U/I/C]** (both **[▲]** and **[▼]**) one or more times to select a desired channel group (U.S.A., International or Canada).
- ② Hold down **[9]**(16) for 1 second to select the Call channel of the selected channel group.
 - “CALL” and the Call channel number appear.
- ③ Hold down **[9]**(16) again for 3 seconds (until a long beep changes to two short beeps) to enter the Call channel programming mode.
 - The channel number starts blinking.
- ④ Push **[▲]** or **[▼]** to select a desired channel.
- ⑤ Push **[9]**(16) to program the displayed channel as the Call channel.
 - Push **[CLR]** to cancel, if desired.
 - The channel number stops blinking.

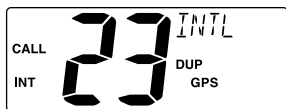
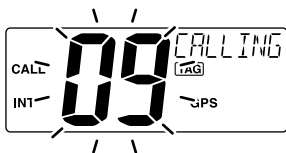

■ Channel comments

The channels can be labeled with a unique alphanumeric ID of up to 10 characters.

The comment appears in the channel comment display for about 10 seconds after the channel selection, and the comment, more than 7 characters long, automatically scrolls.

Capital letters, small letters (except f, j, k, p, s, v, x, z), 0 to 9, some symbols (= * + - . /) and space can be used.

- ① Select a desired channel.
 - Cancel Dualwatch, Tri-watch or Scan in advance.
- ② While holding down **[CH/WX]**, push **[16]** to enter the channel comment programming mode.
 - A cursor and the first character start blinking alternately.
- ③ Push **[▲]** or **[▼]** to select a desired character.
 - Push **[CH/WX]** or **[16]** to move the cursor forward or backward.
- ④ Repeat step ③ to input all characters.
- ⑤ Push **[ENT]** to input and set the comment.
 - Push **[CLR]** to cancel and exit the programming mode, if desired.
 - The cursor and the character stop blinking.
- ⑥ If desired, repeat steps ① to ⑤ to program other channel comments.

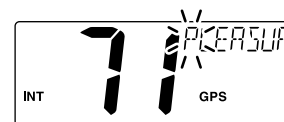

■ Microphone Lock function

The Microphone Lock function electrically locks the [▲] and [▼] keys on the supplied microphone. This prevents accidental channel changes and function access.

- ➔ While holding down [HI/LO] on the microphone, turn ON the power to toggle the Microphone Lock function ON or OFF.

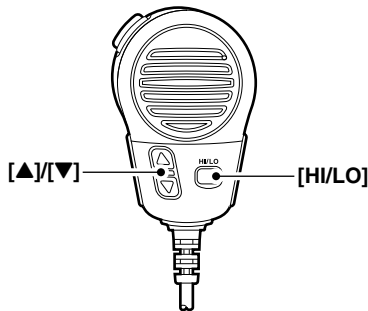

■ Display backlight

The function display and keys can be backlit for better visibility under low light conditions.

You can also adjust the display backlight in the Set mode. (p. 46)

- ➔ While holding down [SCAN], push [▲] or [▼] to adjust the brightness of the LCD and key backlight.
 - The backlight is adjustable in 4 levels and OFF.

■ AquaQuake water draining function

The transceiver uses a technology to clear water away from the speaker grill: AquaQuake. AquaQuake helps drain water away from the speaker housing (water that might otherwise muffle the sound coming from the speaker). The transceiver makes a vibrating noise when this function is being used.

- ➔ While holding down both [▲] and [▼] on the transceiver, turn ON the power to activate the AquaQuake function.
 - While continuing to push [▲] and [▼], a low beep tone sounds to drain water, regardless of the [VOL.] control setting.
 - While the AquaQuake function is activated, the transceiver never accepts any key operations.
 - Release [▲] and [▼] to cancel the AquaQuake function.

■ Scan types

Scanning is an efficient way to locate signals quickly over a wide frequency range. The transceiver has Priority scan and Normal scan.

When the Weather Alert function is turned ON, the previously selected (last used) weather channel is also checked while scanning. (p. 45)

PRIORITY SCAN

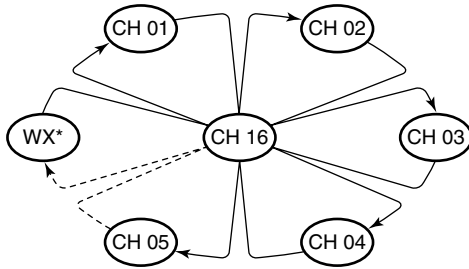

*When the weather alert function is activated.

Priority scan searches through all TAG channels in sequence, while monitoring Channel 16. When a signal is detected on Channel 16, the scan pauses until the signal disappears. When a signal is detected on a channel other than Channel 16, scan becomes Dualwatch until the signal disappears.

Set the TAG channels (scanned channel) before scanning. Clear any TAG channels which inconveniently stop scanning, such as those for digital communication use. (Refer to the next page for details.)

/// Choose Priority or Normal scan in the Set mode. (p. 45)

NORMAL SCAN

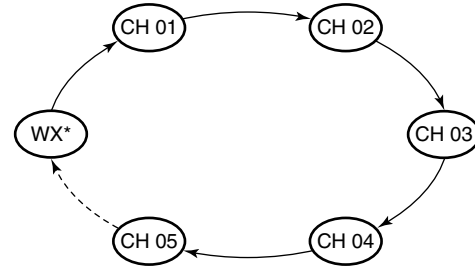

*When the weather alert function is activated.

Normal scan, like Priority scan, searches through all TAG channels in sequence. However, unlike Priority scan, Channel 16 is not checked unless Channel 16 is set as a TAG channel.

■ Setting TAG channels

For more efficient scanning, you can add desired channels as TAG channels, or remove unwanted channels as TAG channels. Channels that are not tagged will be skipped during scanning. TAG channels can be independently assigned to each channel group (USA, INT, CAN).

- ① Push **[U/I/C]** (both **[▲]** and **[▼]**) to select a desired channel group.
- ② Select a desired channel to be set as a TAG channel.
- ③ Hold down **[TAG](SCAN)** for 1 second to set the channel as a TAG channel.
 - “**TAG**” appears.
- ④ To cancel the TAG channel setting, repeat step ③.
 - “**TAG**” disappears.

✓ Clearing (or setting) all tagged channels

While holding down **[HI/LO]** on the microphone, hold down **[TAG](SCAN)** for 3 seconds (until a long beep changes to two short beeps) to clear all TAG channels in the channel group.

- Repeat above procedure to set all TAG channels.

■ Starting a scan

First, set scan type (Priority or Normal scan) and the scan resume timer in the Set mode. (p. 45)

- ① Push **[U/I/C]** (both **[▲]** and **[▼]**) to select a desired channel group.
- ② Set TAG channels as described at left.
- ③ Make sure the squelch is closed to start a scan.
- ④ Push **[SCAN]** to start Priority or Normal scan.
 - “**SCAN**” blinks in the channel comment display during scanning. (During Priority scan, “16” appears beside the blinking “**SCAN**” indication.)
 - A beep tone sounds and “16” blinks in the channel comment display when a signal is received on Channel 16 during Priority scan.
 - When a signal is detected, the scan pauses until the signal disappears or resumes after pausing 5 seconds, depending on the Set mode setting. (Channel 16 is still monitored during Priority scan.)
 - Push **[▲]** or **[▼]** to check the scanning TAG channels, to change the scanning direction or to manually resume the scan.
- ⑤ To stop the scan, push **[SCAN]** again.

[Example]: Starting a Normal scan.

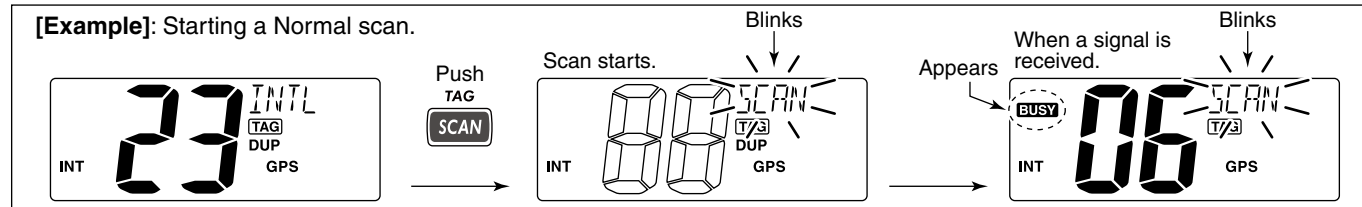

■ Description

Dualwatch monitors Channel 16 while you are receiving on another channel; Tri-watch monitors Channel 16 and the Call channel while receiving another channel. Dualwatch and Tri-watch are convenient for monitoring Channel 16 when you are operating on another channel.

DUALWATCH/TRI-WATCH SIMULATION

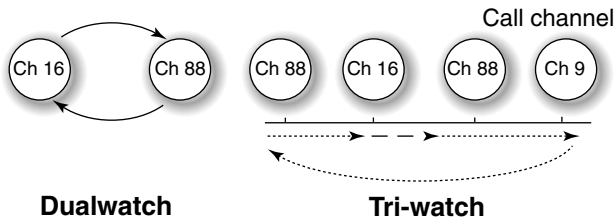

- If a signal is received on Channel 16, Dualwatch and Tri-watch pause on Channel 16 until the signal disappears.
- If a signal is received on the Call channel during Tri-watch, Tri-watch becomes Dualwatch until the signal disappears.
- To transmit on the selected channel during Dualwatch or Tri-watch, hold down [PTT].

■ Operation

- ① Select Dualwatch or Tri-watch in the Set mode. (p. 46)
- ② Push [▲] or [▼] to select a desired channel.
- ③ Hold down [DUAL](CH/WX) for 1 second to start Dualwatch or Tri-watch.
 - “DW” blinks during Dualwatch; “TW” blinks during Tri-watch.
 - A beep tone sounds and “16” blinks when a signal is received on Channel 16.
- ④ To cancel Dualwatch/Tri-watch, push [DUAL](CH/WX) again.

[Example]: Operating Tri-watch on INT Channel 25

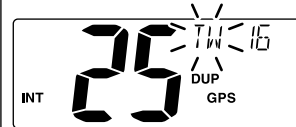

Tri-watch starts.



Signal is received on the Call channel.

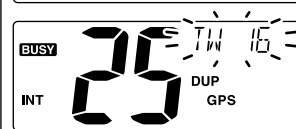

Signal is received on Channel 16 takes priority.

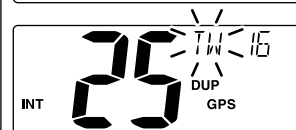

Tri-watch resumes after the signal disappears.

■ MMSI code programming

The 9-digit MMSI (Maritime Mobile Service Identity: DSC self ID) code can be programmed at power ON.

/// This code programming can be performed only twice. After the code programming, it can be changed only by your dealer or distributor.

- ① Turn OFF the power.
- ② While holding down **[MMSI](MENU)**, turn ON the power to enter the MMSI code programming mode.
- ③ After the display appears, release **[MMSI](MENU)**.
- ④ Push **[MENU]** to enter the DSC menu.
- ⑤ Push **[▲]** or **[▼]** to select "MMSI," then push **[ENT]**.
 - A cursor starts blinking.



- ⑥ Push **[▲]** or **[▼]** to select the specified MMSI code.
 - Push **[CH/WX]** or **[16]** to move the cursor forward or backward.
- ⑦ After programming the 9-digit MMSI code, push **[ENT]**.
 - "CONFIRMATION" scrolls in the channel comment display.

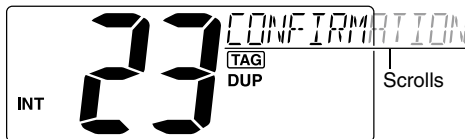

- ⑧ Push **[ENT]**, then input the same MMSI code as step ⑥ for the confirmation.
- ⑨ Push **[ENT]** to set the code.
 - Selects to normal operation.
 - Push **[CLR]** to cancel and exit the programming mode, if desired.
 - If a different code is input, "INCORRECT" appears. In that case, push **[ENT]** to repeat steps ⑥ to ⑧ again.

◇ MMSI code check

The 9-digit MMSI (DSC self ID) code can be checked.

- While in the stand-by mode, hold down **[MMSI](MENU)** for 1 second to display the 9-digit MMSI (DSC self ID) code.
 - The MMSI code is displayed and scrolls in the channel comment display.
 - When no MMSI code is programmed, "NO MMSI" appears and warning alarm sounds.

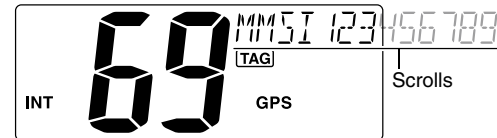

6 DSC OPERATION

■ DSC address ID

A total of 100 9-digit DSC address IDs can be programmed and named with up to 10 characters.

◇ Programming Address ID

- ① Push **[MENU]** to enter the DSC menu.
- ② Push **[▲]** or **[▼]** to select “ADDRESS,” then push **[ENT]**.



- ③ Push **[▲]** or **[▼]** to select “ADD INDV ID,” then push **[ENT]**.



- ④ Push **[▲]** or **[▼]** to set the 9-digit Individual ID, then push **[ENT]**.
 - Push **[CH/WX]** or **[16]** to move the cursor forward or backward.
 - Push **[CLR]** to cancel and exit the programming mode, if desired.



- ⑤ Push **[▲]** or **[▼]** to set up to a 10-character ID name.
 - Push **[CH/WX]** or **[16]** to move the cursor forward or backward.
 - Push **[CLR]** to cancel and exit the programming mode, if desired.



- ⑥ Push **[ENT]** to program and return to normal operation.

◇ **Deleting Address ID**

- ① Push [MENU] to enter the DSC menu.
- ② Push [▲] or [▼] to select “ADDRESS,” then push [ENT].



- ③ Push [▲] or [▼] to select “DEL INDV ID,” then push [ENT].
 - When no address ID is programmed, “NO ID” is displayed.



- ④ Push [▲] or [▼] to select a desired ID name for deleting and then push [ENT].
 - “READY” appears.



- ⑤ Push [ENT] to delete the selected address ID and return to normal operation.

◇ **Programming Group ID**

- ① Push [MENU] to enter the DSC menu.
- ② Push [▲] or [▼] to select “ADDRESS,” then push [ENT].



- ③ Push [▲] or [▼] to select “ADD GROUP ID,” then push [ENT].



- ④ Push [▲] or [▼] to set the 9-digit Group ID, then push [ENT].
 - Push [CH/WX] or [16] to move the cursor forward or backward.
 - Push [CLR] to cancel and exit the programming, if desired.
 - ▨ The first one digit is specified '0' for a Group ID.
 - ▨ The first two digits are '0' for any Coast station ID.

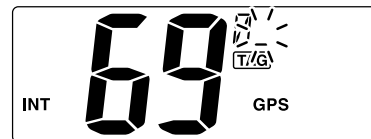

☞ Continued on the next page

6 DSC OPERATION

■ DSC address ID

◇ Programming Group ID (Continued)

- ⑤ Push [▲] or [▼] to set up to a 10-character ID name.
 - Push [CH/WX] or [16] to move the cursor forward or backward.
 - Push [CLR] to cancel and exit the programming mode, if desired.



- ⑥ Push [ENT] to program and return to normal operation.

◇ Deleting Group ID

- ① Push [MENU] to enter the DSC menu.
- ② Push [▲] or [▼] to select "ADDRESS," then push [ENT].



- ③ Push [▲] or [▼] to select "DEL GROUP ID," push [ENT].
 - When no group ID is programmed, "NO ID" is displayed.



- ④ Push [▲] or [▼] to select a desired ID name for deleting and push [ENT].
 - "READY" appears.

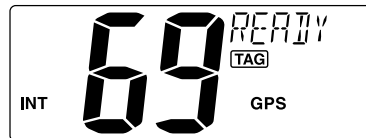

- ⑤ Push [ENT] to delete the selected group ID and return to normal operation.

■ Position and time programming

A Distress call should include the ship's position and time data. If no GPS is connected, your position and UTC (Universal Time Coordinated) time should be input manually. They are included automatically when a GPS receiver is connected (NMEA0183 ver. 2.0 or 3.01).

- ① Push **[MENU]** to enter the DSC menu.
- ② Push **[▲]** or **[▼]** to select "POSITION INPUT," then push **[ENT]**.



- ③ Push **[▲]** or **[▼]** to enter your latitude data. After entering the data, push **[ENT]** to set your longitude data.
 - Push **[CH/WX]** or **[16]** to move the cursor forward or backward.
 - Push **[▲]** or **[▼]** to edit N; North latitude or S; South latitude when the cursor is on the 'N' or 'S' position, and W; West longitude or E; East longitude when the cursor is on the 'W' or 'E' position.
 - Push **[CLR]** to cancel and exit the programming mode, if desired.



- ④ After setting the longitude data, push **[ENT]** to set the current UTC time using **[▲]** or **[▼]**.
 - Push **[CH/WX]** or **[16]** to move the cursor forward or backward.
 - Push **[CLR]** to cancel and exit the programming, if desired.



- ⑤ Push **[ENT]** to program and return to normal operation.

Manually programmed position data will be held only for 23.5 hours. "??" may blink instead of position and time indications when the GPS data is invalid, or has not been manually updated after 4 hours.

6 DSC OPERATION

■ Position indication

When a GPS receiver is connected, the transceiver displays the current position data with an accuracy in seconds.

A NMEA0183 ver. 2.0 or 3.01 (sentence formatters RMC, GGA, GNS, GLL) compatible GPS receiver is required. Ask your dealer about suitable GPS receivers.

- 'Latitude,' 'Longitude' and UTC time data scroll in sequence in the channel comment display.
 - Channel comments are displayed for about 10 seconds after the channel selection.
- "NO POSITION" and "NO TIME" scroll when no GPS is connected.

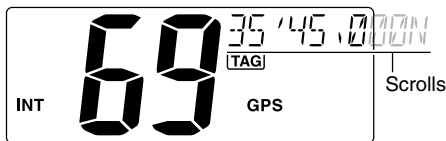

- When the GPS receiver is compatible with several sentence formatters, the order of input precedence is 'RMC,' 'GGA,' 'GNS' and 'GLL.'
- "GPS" blinks when the GPS data is invalid.

■ Distress call

A Distress call should be transmitted whenever, in the opinion of the Master, the ship or a person is in distress and requires immediate assistance.

NEVER USE THE DISTRESS CALL WHEN YOUR SHIP OR A PERSON IS NOT IN AN EMERGENCY. A DISTRESS CALL CAN BE USED ONLY WHEN IMMEDIATE HELP IS NEEDED.

◇ Simple call

- ① Confirm no Distress call is being received.
- ② While lifting up the key cover, hold down **[DISTRESS]** for 3 seconds to transmit the Distress call.
 - Emergency channel (Channel 70) is automatically selected and the Distress call is transmitted.
 - While holding down **[DISTRESS]**, the key backlighting blinks.



- ③ After transmitting the Distress call, the transceiver waits for an acknowledgment call.
 - The Distress call is automatically transmitted every 3.5 to 4.5 minutes.
 - "DSC REPEAT" scrolls in the channel comment display on Channel 16.



- ④ After receiving the acknowledgment, reply using the microphone.
- “RCV DISTRESS ACK” scrolls in the channel comment display.



- ➔ A distress alert contains;
 - Kinds of distress: Undesignated distress
 - Position data : The latest GPS or manual input position data is held for 23.5 hours, or until the power is turned OFF.
- ➔ The Distress call is repeated every 3.5 to 4.5 minutes, until receiving an ‘acknowledgement.’ (‘Call repeat mode’)
 - “RE-TRANSMISSION” is displayed while transmitting.
- ➔ Push **[DISTRESS]** to transmit a renewed Distress call, if desired.

◇ Regular call

The nature of the distress should be included in the Distress call.

- ① Push **[MENU]** to enter the DSC menu.
- ② Push **[▲]** or **[▼]** to select “DISTRESS,” and then push **[ENT]**.



- ③ Push **[▲]** or **[▼]** to select the nature of the distress, and then push **[ENT]**.
 - ‘UNDESIGNATED,’ ‘EXPLOSION,’ ‘FLOODING,’ ‘COLLISION,’ ‘GROUNDING,’ ‘CAPSIZING,’ ‘SINKING,’ ‘ADRIFT (Disable adrift),’ ‘ABANDONING (Abandoning ship),’ ‘PIRACY (Piracy attack),’ and ‘MOB (Man overboard)’ are available.
 - The selected nature of the distress is stored for 10 minutes.



⚡ When a GPS receiver is connected, steps ④ and ⑤ (Current position/time programming) do not appear. Go to step ⑥.

6 DSC OPERATION

■ Distress call

◇ Regular call (Continued)

- ④ Push **[▲]** or **[▼]** to set your latitude data. After setting the latitude data, push **[ENT]** to set your longitude data.
- Push **[CH/WX]** or **[16]** to move the cursor forward or backward.
 - Push **[▲]** or **[▼]** to edit N; North latitude or S; South latitude when the cursor is on the 'N' or 'S' position, and W; West longitude or E; East longitude when the cursor is on the 'W' or 'E' position.
 - Push **[CLR]** to cancel and exit the setting, if desired.



- ⑤ After setting the longitude data, push **[ENT]** to set the current UTC time using **[▲]** or **[▼]**, and then push **[ENT]**.
- Push **[CH/WX]** or **[16]** to move the cursor forward or backward.
 - Push **[CLR]** to cancel and exit the setting, if desired.



- ⑥ Push **[DISTRESS]** for 3 seconds to transmit the Distress call.
- While pushing **[DISTRESS]**, the key backlighting blinks.
 - The distress information is stored for 10 minutes.
 - Emergency channel (Channel 70) is automatically selected and the Distress call is transmitted.
 - Push **[CLR]** to exit the state, if desired.

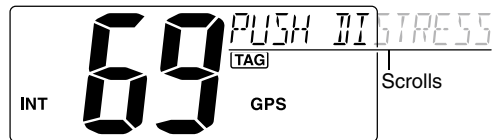

- ⑦ After transmitting the Distress call, the transceiver waits for an acknowledgment call.
- The Distress call is automatically transmitted every 3.5 to 4.5 minutes.
 - "DSC REPEAT" scrolls in the channel comment display on Channel 16.



- ⑧ After receiving the acknowledgment, reply using the microphone.

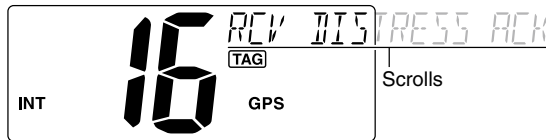

- ➔ A distress alert contains (default);
 - Nature of distress: Selected nature of the distress
 - Position data : GPS or manual input position data is held for 23.5 hours or until the power is turned OFF.
- ➔ The Distress call is repeated every 3.5 to 4.5 minutes, until receiving an 'acknowledgement.' ('Call repeat' mode)
 - "RE-TRANSMISSION" is displayed.
- ➔ Push **[DISTRESS]** to transmit a renewed Distress call, if desired.
- ➔ "???" may blink instead of position and time indications when the GPS data is invalid, or has not been manually updated after 4 hours.

■ Transmitting DSC calls

- /// To ensure correct operation of the DSC function, please make sure you set the squelch correctly. (p. 7)

◇ Transmitting an Individual call

The Individual call function allows you to transmit a DSC signal to a specific ship or a Coast station.

✓ Convenient

When the Icom MA-500TR CLASS B AIS TRANSPONDER is connected to your transceiver, an individual DSC call can be transmitted to a selected AIS target using the transponder, without needing to enter the target's MMSI code.

See the MA-500TR instruction manual for more details.

- ① Push **[MENU]** to enter the DSC menu.
- ② Push **[▲]** or **[▼]** to select "INDIVIDUAL," then push **[ENT]**.



ⓘ Continued on the next page

6 DSC OPERATION

■ Transmitting DSC calls

◇ Transmitting an Individual call (Continued)

- ③ Push [▲] or [▼] to select a desired pre-programmed Individual address or “MANUAL INPUT,” then push [ENT].
- The ID code for the individual can be set in advance. (p. 14)
 - When “MANUAL INPUT” is selected, set the 9-digit MMSI ID code for the individual you wish to call with [▲] or [▼]. (See **About Manual Inputting** at the right column.)



About Manual Inputting:

Push [▲] or [▼] to input the 9-digit Individual ID, then push [ENT].

- Push [CH/WX] or [16] to move the cursor forward or backward.
- Push [CLR] to cancel and exit the entry, if desired.
- Go to the next step after pushing [ENT].



- ④ Push [▲] or [▼] to select a desired intership channel, then push [ENT].

- Intership channels are already preset into the transceiver in preferred order.
- After pushing [ENT], Channel 70 is automatically selected and “READY” appears in the channel comment display.

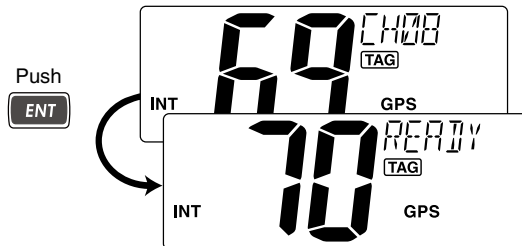

- ⑤ Push [ENT] to transmit the Individual call.

- If Channel 70 is busy, the transceiver stands by until the channel becomes clear.
- Routine category only is available.



- ⑥ Stands by on the operated channel (before entering the DSC menu in step ①), until an acknowledgement call is received.
- “WAITING FOR ACK” scrolls in the channel comment display.



- ⑦ When the acknowledgement is received, beeps sound, and “DSC” appears and “RCV ABLE ACK” or “RCV UNABLE ACK” scrolls in the channel comment display with beeps.
- Push [CLR] to stop the beeps.

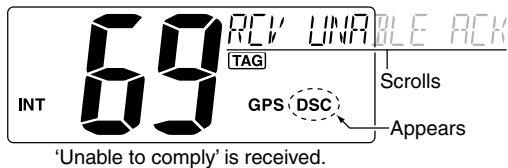
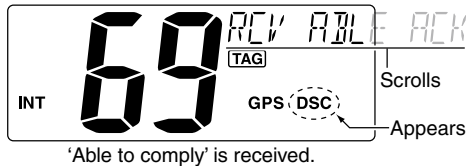

- ⑧ Push [ENT] to select to the intership channel, specified in step ④, then hold down [PTT] to communicate your message to the responding ship when ‘Able to comply’ is received.
- Push [CLR] to return to normal operation.
 - When ‘Unable to comply’ is received, push [ENT] to return to normal operation.

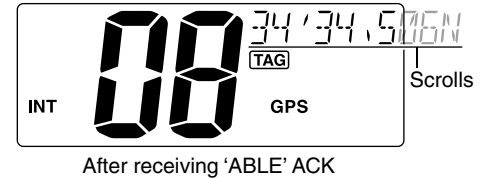

6 DSC OPERATION

■ Transmitting DSC calls (Continued)

◇ Transmitting an Individual acknowledgement

When receiving an Individual call, you can transmit an acknowledgement ('Able to comply' or 'Unable to comply') by using the on screen prompts (Quick ACK.) Also, you can send an acknowledgement through the menu system (Manual ACK.)

Quick ACK:

➤ After an Individual call is received, push [CLR] to stop the beeps, and then push [ENT]. (Go to step ④ below.)

Manual ACK:

- ① Push [MENU] to enter the DSC menu.
- ② Push [▲] or [▼] to select "INDV ACK," then push [ENT].
 - "INDV ACK" item appears after receiving an Individual call.



- ③ Push [▲] or [▼] to select a desired individual address or ID code, then push [ENT].

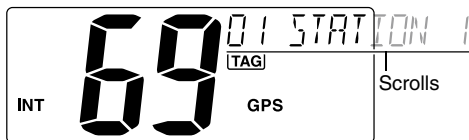

- ④ Push [▲] or [▼] to select the acknowledgement "ABLE" or "UNABLE," then push [ENT].
 - "UNABLE" selection will transmit the reason "No Reason Given".
 - After pushing [ENT], Channel 70 is automatically selected and "READY" appears in the channel comment display.

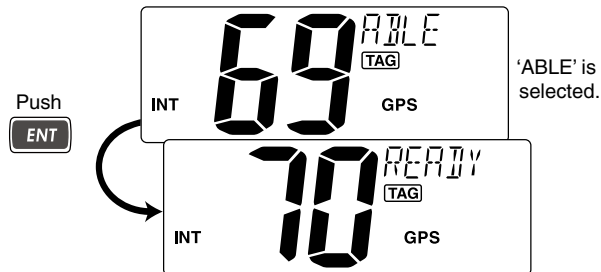

- ⑤ Push [ENT] to transmit the acknowledgement call to the selected station.



- ⑥ After the Individual acknowledgement call has been transmitted, the specified channel (specified by the calling station) is automatically selected when “ABLE” is selected. Or the display returns to the previous screen (before entering the DSC menu) when “UNABLE” is selected in step ③.

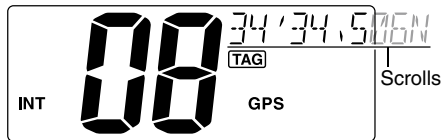

After transmitting 'ABLE' ACK

◇ **Transmitting a Group call**

The Group call function allows you to transmit a DSC signal to a specific group only.

- ① Push [MENU] to enter the DSC menu.
- ② Push [▲] or [▼] to select “GROUP,” then push [ENT].



- ③ Push [▲] or [▼] to select a desired pre-programmed Group address or “MANUAL INPUT,” then push [ENT].
 - The ID code for the group can be set in advance. (p. 15)
 - When “MANUAL INPUT” is selected, set the 8-digit MMSI ID code for the group you wish to call with [▲] or [▼]. (See **About Manual Inputting** on the next page.)



↳ Continued on the next page

6 DSC OPERATION

■ Transmitting DSC calls

◇ Transmitting a Group call (Continued)

About Manual Inputting:

Push [▲] or [▼] to input the 8-digit Group ID, then push [ENT].

- Push [CH/WX] or [16] to move the cursor forward or backward.
- Push [CLR] to cancel and exit the entry.
- The first one digit is specified '0' for a Group ID.
The first two digits are '0' for any Coast station ID.
- Go to the next step after pushing [ENT].



④ Push [▲] or [▼] to select a desired intership channel, then push [ENT].

- Intership channels are already preset into the transceiver in recommending order.
- After pushing [ENT], Channel 70 is automatically selected and "READY" appears in the channel comment display.

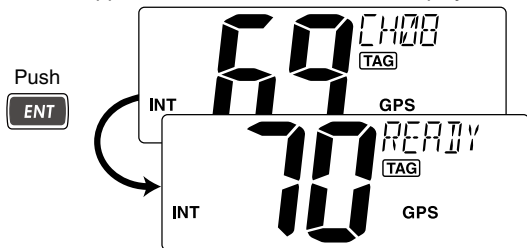

⑤ Push [ENT] to transmit the Group call.

- If Channel 70 is busy, the transceiver stands by until the channel becomes clear.
- Routine category only is available.



⑥ After the Group call has been transmitted, the specified channel (in step ④) is automatically selected.

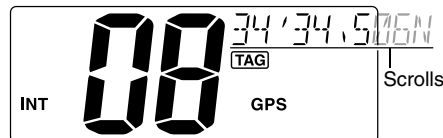

⑦ Hold down [PTT] to announce your message to the specified group ships.

◇ Transmitting an All Ships call

Large ships use Channel 70 as their 'listening channel.' When you want to announce a message to these ships within range, use the 'All Ships call' function.

- ① Push [MENU] to enter the DSC menu.
- ② Push [▲] or [▼] to select "ALL SHIPS," then push [ENT].



- ③ Push [▲] or [▼] to select the desired category, then push [ENT].



- ④ Push [▲] or [▼] to select a desired ITU channel, then push [ENT].
 - After pushing [ENT], Channel 70 is automatically selected and "READY" appears in the channel comment display.

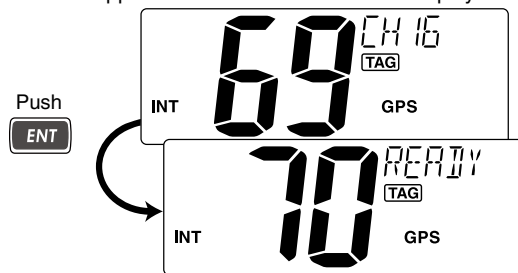

- ⑤ Push [ENT] to transmit the All Ships call.



- ⑥ After the All Ships call has been transmitted, the specified channel (in step ④) is automatically selected.



6 DSC OPERATION

■ Transmitting DSC calls (Continued)

◇ Transmitting a Position Request call

Transmit a Position Request call when you want to know a specified ship's current position, etc.

- ① Push [MENU] to enter the DSC menu.
- ② Push [▲] or [▼] to select "POS REQUEST," then push [ENT].



- ③ Push [▲] or [▼] to select a desired pre-programmed Individual address or "MANUAL INPUT," then push [ENT].
 - The ID code for the individual can be set in advance. (p. 14)
 - When "MANUAL INPUT" is selected, set the 9-digit MMSI ID code for the individual you wish to call with [▲] or [▼]. (See **About Manual Inputting** on page 22.)

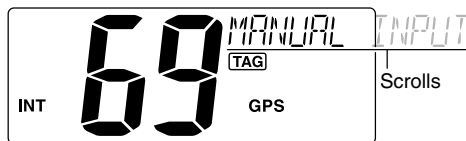

- ④ After step ③, Channel 70 is automatically selected and "READY" appears in the channel comment display.

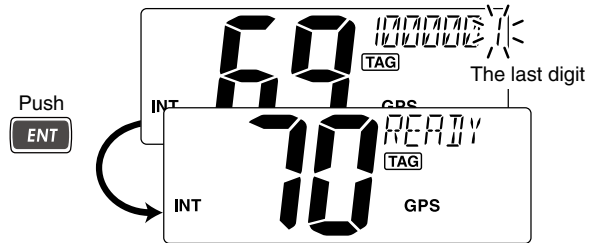

*This illustration describes with "MANUAL INPUT" selection in step ③.

- ⑤ Push [ENT] to transmit the Position Request call.
 - If Channel 70 is busy, the transceiver stands by until the channel becomes clear.



- ⑥ After the Position Request call has been transmitted, return to normal operation (before entering the DSC menu).



◇ **Transmitting a Position Reply call**

Transmit a Position Reply call when a Position Request call is received.

- ① Push [MENU] to enter the DSC menu.
- ② Push [▲] or [▼] to select “POS REPLY,” then push [ENT].
 - “POS REPLY” item appears after receiving a Position Request call.



- ③ Push [▲] or [▼] to select a desired individual address, then push [ENT].

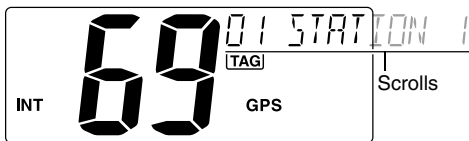

- ④ The position information appears. Input your position data (latitude and longitude) directly with [▲] or [▼]. (p. 17)

- ⑤ After editing the position data, push [ENT] to set. Then edit the current UTC time directly with [▲] or [▼] (p. 17), then push [ENT].
 - After pushing [ENT], Channel 70 is automatically selected and “READY” appears in the channel comment display.



- ⑥ Push [ENT] to transmit the Position Reply call.



- ⑦ After the Position Reply call has been transmitted, return to normal operation (before entering the DSC menu).



6 DSC OPERATION

■ Transmitting DSC calls (Continued)

◇ Transmitting a Polling Request call

Transmit a Polling Request call when you want to know a specific ship is in the communication area, or not.

- ① Push **[MENU]** to enter the DSC menu.
- ② Push **[▲]** or **[▼]** to select "POLL REQUEST," then push **[ENT]**.



- ③ Push **[▲]** or **[▼]** to select a desired pre-programmed individual address or "MANUAL INPUT," then push **[ENT]**.
 - The ID code for the individual can be set in advance. (p. 14)
 - When "MANUAL INPUT" is selected, set the 9-digit MMSI ID code for the individual you wish to call with **[▲]** or **[▼]**. (See **About Manual Inputting** on page 22.)



- ④ After step ③, Channel 70 is automatically selected and "READY" appears in the channel comment display.

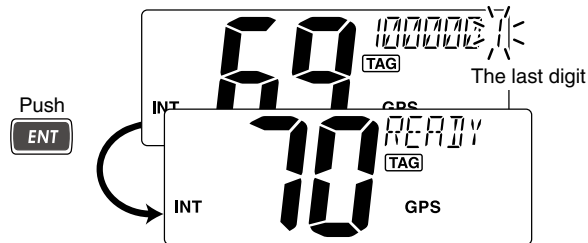

*This illustration describes with "MANUAL INPUT" selection in step ③.

- ⑤ Push **[ENT]** to transmit the Polling Request call.
 - If Channel 70 is busy, the transceiver stands by until the channel becomes clear.



- ⑥ After the Polling Request call has been transmitted, return to normal operation (before entering the DSC menu).

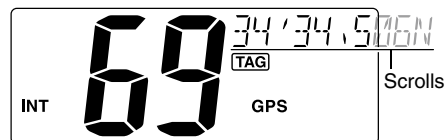

◇ Transmitting a Polling Reply call

Transmit a Polling Reply call when a Polling Request call is received.

- ① Push **[MENU]** to enter the DSC menu.
- ② Push **[▲]** or **[▼]** to select “POLL REPLY,” then push **[ENT]**.
 - “POLL REPLY” item appears after receiving a Polling Request call.



- ③ Push **[▲]** or **[▼]** to select a desired individual address, then push **[ENT]**.
 - After pushing **[ENT]**, Channel 70 is automatically selected and “READY” appears in the channel comment display.

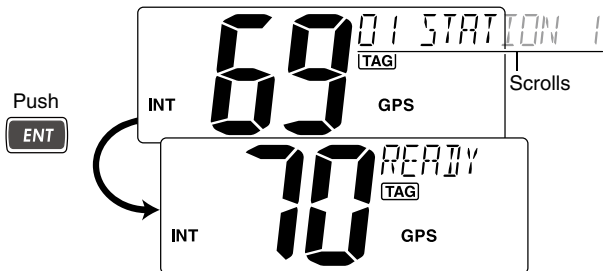

- ④ Push **[ENT]** to transmit the Polling Reply call.



- ⑤ After the Polling Reply call has been transmitted, return to normal operation (before entering the DSC menu).



6 DSC OPERATION

■ Transmitting DSC calls (Continued)

◇ Test call

Testing on the exclusive DSC distress and safety calling channels should be avoided as much as possible by using other methods. When testing on the distress/safety channel is unavoidable, it should be indicated that these are test transmissions.

Normally the test call would require no further communications between the two stations involved.

- ① Push [MENU] to enter the DSC menu.
- ② Push [▲] or [▼] to select "TEST CALL," and then push [ENT].



- ③ Push [▲] or [▼] to select a desired pre-programmed Individual address or "MANUAL INPUT," then push [ENT].
 - The ID code for the individual can be set in advance. (p. 14)
 - When "MANUAL INPUT" is selected, set the 9-digit MMSI ID code for the individual you wish to call with [▲] or [▼]. (See **About Manual Inputting** on page 22.)



- ④ After step ③, Channel 70 is automatically selected and "READY" appears in the channel comment display.

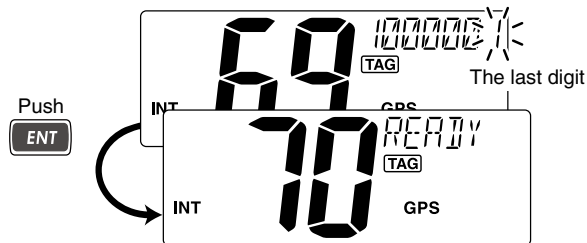

*This illustration describes with "MANUAL INPUT" selection in step ③.

- ⑤ Push [ENT] to transmit the Test call.
 - If Channel 70 is busy, the transceiver stands by until the channel becomes clear.



- ⑥ After the Test call has been transmitted, return to normal operation (before entering the DSC menu).



◆ Transmitting a Test Ack call

Transmit a Test Acknowledgement call when a Test call is received.

- ① Push [MENU] to enter the DSC menu.
- ② Push [▲] or [▼] to select “TEST ACK,” then push [ENT].
 - “TEST ACK” item appears after receiving a Test call.



- ③ Push [▲] or [▼] to select a desired individual address, then push [ENT].
 - After pushing [ENT], Channel 70 is automatically selected and “READY” appears in the channel comment display.

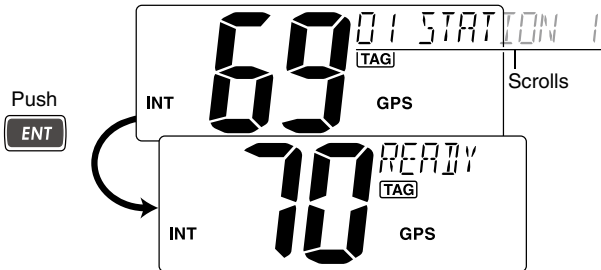

- ④ Push [ENT] to transmit the Test Ack call.



- ⑤ After the Test Ack call has been transmitted, return to normal operation (before entering the DSC menu).



■ Receiving DSC calls

◇ Receiving a Distress call

When a Distress call is received:

- The emergency alarm sounds for 2 minutes.
 - Push any key to stop the alarm.
- “DSC” appears and “RCV DISTRESS” scrolls in the channel comment display, then Channel 16 is automatically selected.
 - ▨ This action can be changed, depending on the combination of the Auto Switch function and Auto Tune timer settings. See pages 39 and 40 for more details.
- Continue monitoring Channel 16 as a coast station may require assistance.

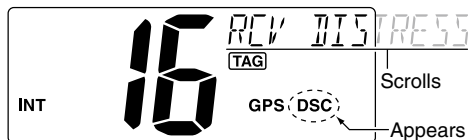

◇ Receiving a Distress Acknowledgement

When a Distress acknowledgement to other ship is received:

- The emergency alarm sounds for 2 minutes.
 - Push any key to stop the alarm.
- “DSC” appears and “RCV DISTRESS ACK” scrolls in the channel comment display, then Channel 16 is automatically selected.
 - ▨ This action can be changed, depending on the combination of the Auto Switch function and Auto Tune timer settings. See pages 39 and 40 for more details.

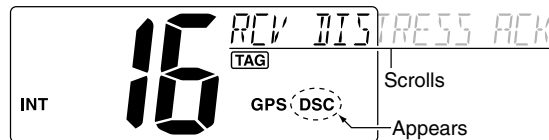

◇ Receiving a Distress Relay call

When a Distress Relay is received:

- The emergency alarm sounds for 2 minutes.
 - Push any key to stop the alarm.
 - “DSC” appears and “RCV RELAY” scrolls in the channel comment display, then Channel 16 is automatically selected.
- ▨ This action can be changed, depending on the combination of the Auto Switch function and Auto Tune timer settings. See pages 39 and 40 for more details.

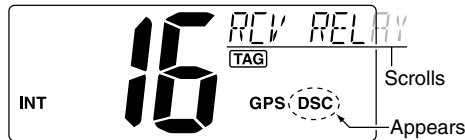

◇ Receiving a Distress Relay Acknowledgement

When a Distress Relay acknowledgement is received:

- The emergency alarm sounds for 2 minutes.
 - Push any key to stop the alarm.
 - “DSC” appears and “RCV RELAY ACK” scrolls in the channel comment display, then Channel 16 is automatically selected.
- ▨ This action can be changed, depending on the combination of the Auto Switch function and Auto Tune timer settings. See pages 39 and 40 for more details.

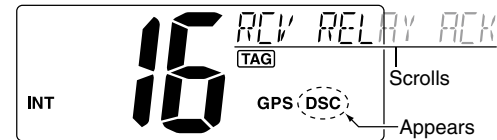

▨ **NOTE:** The alarm sounds when duplicate distress relay or distress relay acknowledgement call for individual is received within 1 hour.

6 DSC OPERATION

■ Receiving DSC calls (Continued)

◇ Receiving an Individual call

When an Individual call is received:

- The emergency alarm or beeps sound for 2 minutes depending on the received category.
 - Push **[CLR]** to stop the alarm or beeps.
- **"DSC"** appears and **"RCV INDIVIDUAL"** scrolls in the channel comment display.



- Push **[ENT]** to reply the call and select the channel specified by the calling station for voice communication (depending on your replying setting. See page 24 for details of the Individual acknowledgement call procedure.); push **[CLR]** to ignore the call.

◇ Receiving a Group call

When a Group call is received:

- The emergency alarm or beeps sound for 2 minutes depending on the received category.
 - Push **[CLR]** to stop the alarm or beeps.
- **"DSC"** appears and **"RCV GROUP"** scrolls in the channel comment display.
- Push **[ENT]** to select the channel specified by the calling station for voice communication; push **[CLR]** to ignore the call.

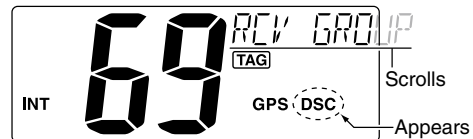

◇ Receiving an All Ships call

When an All Ships call is received:

- The emergency alarm sounds for 2 minutes, depending on the received categories.
 - Push **[CLR]** to stop the alarm or beeps.
- “**DSC**” appears and “RCV ALL SHIPS” scrolls in the channel comment display.
- Push **[ENT]** to monitor Channel 16 for an announcement from the calling vessel, push **[CLR]** to ignore the call.

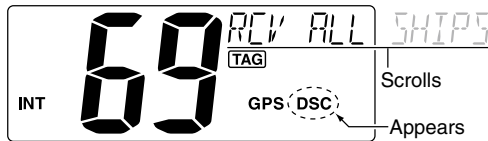

◇ Receiving a Geographical Area call

When a Geographical Area call (for the area you are in) is received:

- The emergency alarm or beeps sound for 2 minutes, depending on the received category.
 - Push **[CLR]** to stop the alarm or beeps.
- “**DSC**” appears and “RCV GEOGRAPHICAL” scrolls in the channel comment display.

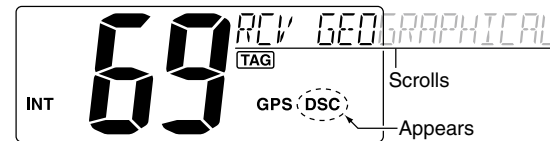

- Push **[ENT]** to select the channel specified by the calling station for voice communication; push **[CLR]** to ignore the call.
- Monitor the selected channel for an announcement from the calling station.

▨ When no GPS receiver is connected or if there is a problem with the connected receiver, all Geographical Area calls are received, regardless of your position.

6 DSC OPERATION

■ Receiving DSC calls (Continued)

◇ Receiving a Position Request call

When a Position Request call is received:

- “DSC” appears and “RCV POS REQUEST” scrolls in the channel comment display.
- The beeps sound for 2 minutes.
 - Push [CLR] to stop the beeps.
- Push [ENT] to reply to the call; push [CLR] to ignore the call.

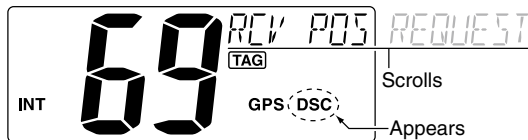

◇ Receiving a Polling Request call

When a Polling Request call is received:

- “DSC” appears and “RCV POLL REQUEST” scrolls in the channel comment display.
- The beeps sound for 2 minutes.
 - Push [CLR] to stop the beeps.
- Push [ENT] to reply to the call; push [CLR] to ignore the call.

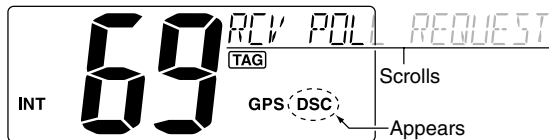

◇ Receiving a Position Reply call

When a Position Reply call is received:

- “DSC” and “POS REPLY” appear in the display.
 - The ‘Latitude’ and ‘Longitude’ from the called station are scrolled in the channel comment display first Latitude co-ordinates and then Longitude co-ordinates.
 - “NO POSITION” scrolls in the channel comment display when no position information is received.
- The beeps sound for 2 minutes.
 - Push [CLR] to stop the beeps.



◇ Receiving a Polling Reply call

When a Polling Reply call is received:

- “DSC” appears and “RCV POLL REPLY” scrolls in the channel comment display.
- The beeps sound for 2 minutes.
 - Push [CLR] to stop the beeps.

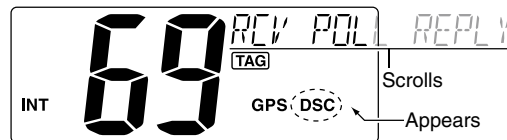

◇ Receiving a Test call

When a Test call is received:

- ➔ “DSC” appears and “RCV TEST CALL” scrolls in the channel comment display.
- ➔ The beeps sound for 2 minutes.
 - Push [CLR] to stop the beeps.
- ➔ Push [ENT] to reply to the call; push [CLR] to ignore the call.

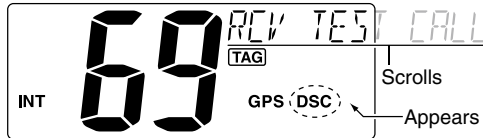

◇ Receiving a Test Acknowledgement call

When a Test Acknowledgement call is received:

- ➔ “DSC” appears and “RCV TEST ACK” scrolls in the channel comment display.
- ➔ The beeps sound for 2 minutes.
 - Push [CLR] to stop the beeps.
- ➔ Push [ENT] to reply to the call; push [CLR] to ignore the call.

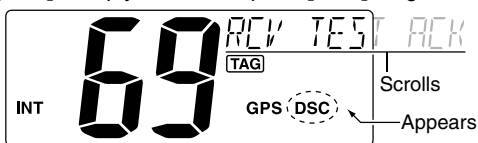

◇ Auto Switch function

By regulation, after receiving a Distress call, the transceiver basically switches the operating channel to Channel 16. However, when this setting is set to “OFF,” the function enables the transceiver to remain on the operating channel even after receiving a Distress call.

- ① Push [MENU] to enter the DSC menu.
- ② Push [▲] or [▼] to select “AUTO SW,” then push [ENT].



- ③ Push [▲] or [▼] to select the Auto switch “ON” or “OFF.”
 - Push [CLR] to cancel and exit the setting, if desired.



OFF : The transceiver remains on the operating channel even after receiving a Distress call.

ON : The transceiver automatically switches the operating channel to Channel 16 after receiving a Distress call. (default)

- ④ Push [ENT] to set and exit the setting.

6 DSC OPERATION

■ Receiving DSC calls (Continued)

◇ Auto Tune timer

This is the amount of time after receiving a Distress call before the transceiver switches to Channel 16.

- ① Push **[MENU]** to enter the DSC menu.
- ② Push **[▲]** or **[▼]** to select "AUTO TUNE," then push **[ENT]**.



- ③ Push **[▲]** or **[▼]** to set the Auto tune timer period to between 10 and 600 seconds (1 second steps) or turn OFF.
 - Push **[CLR]** to cancel and exit the setting, if desired.

OFF : Turns OFF the Auto Tune timer.

10 to 600 : After receiving a Distress call, the transceiver remains on the operating channel for the programmed time period between 10 and 600 seconds, and then automatically switches to Channel 16. (default : 30)

Within the programmed timer period, the following action can be taken:

- When the **[ENT]** key is pushed, immediately switches to Channel 16.
- When the **[CLR]** key is pushed, the Auto tune timer is cancelled and the transceiver remains on the operating channelled.

- ④ Push **[ENT]** to set and exit the setting.

The action of the transceiver may differ, depending on the combination of the Auto Switch function and the Auto Tune timer settings.

• Combined operation when receiving a DSC call:

		Auto Switch	
		OFF	ON
Auto tune	OFF	The transceiver remains on the operating channel. • "AUTO SW OFF" scrolls in the channel comment display.	The transceiver automatically switches to Channel 16.
	ON (10 to 600)	The transceiver remains on the operating channel for the programmed time period, and then automatically switches to Channel 16. Within the programmed timer period, the following action can be taken: • When the [ENT] key is pushed, immediately switches to Channel 16. • When the [CLR] key is pushed, remains on the operating channel since the Auto Tuner timer is cancelled.	

■ Received messages

The transceiver automatically stores up to 20 distress messages and 20 other messages. The messages can be used as an assistance to the logbook.

◇ Distress message

- ① Push [MENU] to enter the DSC menu.
- ② Push [▲] or [▼] to select "DSC LOG," then push [ENT].



- ③ Push [▲] or [▼] to select "DISTRESS," then push [ENT].



- ④ Push [▲] or [▼] to select a desired message, push [ENT].
 - "*" appears when the unread messages is selected.

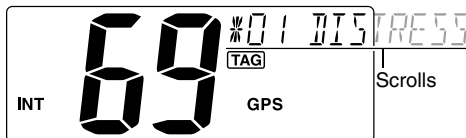

- ⑤ The message information scrolls.
 - The stored message has various information.
 - Push [CLR] to return to the channel comment display.
 - Hold down [CLR] for 1 second to delete the displayed message and return to the DSC menu.



6 DSC OPERATION

■ Received messages (Continued)

◇ Other messages

- ① Push [MENU] to enter the DSC menu.
- ② Push [▲] or [▼] to select "DSC LOG," then push [ENT].



- ③ Push [▲] or [▼] to select "OTHER," then push [ENT].



- ④ Push [▲] or [▼] to select a desired message, push [ENT].
 - "*" appears when the unread messages is selected.

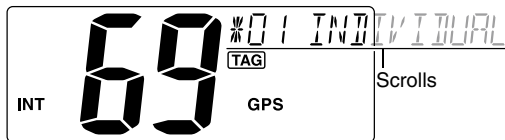

- ⑤ The message information scrolls.
 - The stored message has various information.
 - Push [CLR] to return to the channel comment display.
 - Hold down [CLR] for 1 second to delete the displayed message and return to the DSC menu.



■ Automatic acknowledgement

This item sets the automatic acknowledgement function ON or OFF.

When a position request or polling request call is received, transceiver automatically transmits a position reply or polling reply call.

- ① Push **[MENU]** to enter the DSC menu.
- ② Push **[▲]** or **[▼]** to select “AUTO ACK,” then push **[ENT]**.



- ③ Push **[▲]** or **[▼]** to turn the automatic acknowledgement function ON or OFF.



- ④ Push **[ENT]** to set the Automatic acknowledgement setting.
 - Push **[CLR]** to cancel and exit the setting, if desired.

■ Offset time

This item sets the offset time from the UTC (Universal Time Coordinated) time.

- ① Push **[MENU]** to enter the DSC menu.
- ② Push **[▲]** or **[▼]** to select “OFFSET TIME,” then push **[ENT]**.



- ③ Set the offset time from the UTC (Universal Time Coordinated) time using **[▲]** or **[▼]**.
 - Push **[CH/WX]** or **[16]** to move the cursor forward or backward.
 - Push **[CLR]** to cancel and exit the setting, if desired.



- ④ Push **[ENT]** to program and then to exit the programming mode.

/// The local time indication is not available when the GPS receiver (sentence formatter RMC) is connected, the transceiver's display indicates UTC time only.

■ Set mode programming

Set mode is used to change the settings of the transceiver's functions: Scan type, Scan resume timer, Weather alert, Dual/Tri-watch, Operation beep, LCD backlight, LCD contrast, AF level adjustment, Favorite channel and Remote ID.

▨ Available functions may differ, depending on dealer setting.

- ① Turn power OFF.
- ② While pushing [16], turn ON the power to enter the Set mode.
 - "SCAN" appears in the channel comment display.
- ③ After the display appears, release [16].
- ④ Push [16] to select a desired item, if necessary.
- ⑤ Push [▲] or [▼] to select the desired setting of the item.
- ⑥ Turn power OFF, then ON again to exit the Set mode.

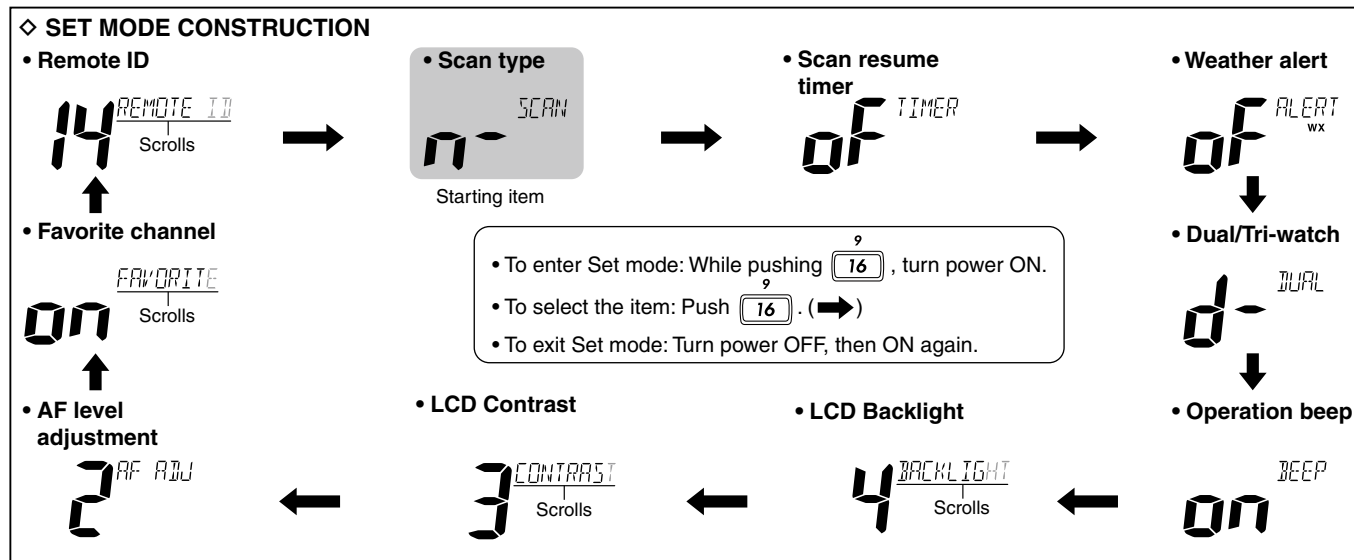

■ Set mode items

◇ Scan type

The transceiver has two scan types: Normal scan and Priority scan. Normal scan searches all TAG channels in the selected channel group. Priority scan searches all TAG channels in sequence while monitoring Channel 16.



Normal scan (default)

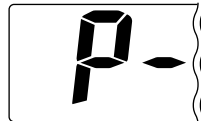

Priority scan

◇ Scan resume timer

The scan resume timer can be selected as a pause (OFF) or timer scan (ON).

ON : The scan pauses 5 seconds and resumes even if a signal has been received on any other channel than Channel 16.

OFF : The scan pauses until the signal disappears.



Scan timer OFF (default)



Scan timer ON

◇ Weather alert

A NOAA broadcast station transmits a weather alert tone before important weather information.

When the Weather Alert function is turned ON, the transceiver detects the alert, then the “WX ALT” icon blinks until the transceiver is operated. The previously selected (used) weather channel is checked while scanning.

• “WX ALT” appears when the Weather Alert function is turned ON.



Weather alert OFF (default)

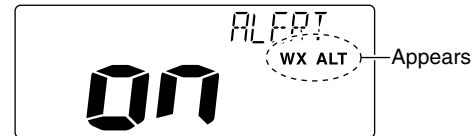

Weather alert ON

7 SET MODE

◇ Dual/Tri-watch

This item can be selected as Dualwatch or Tri-watch. (p. 12)

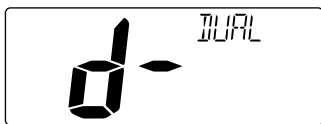

Dualwatch (default)

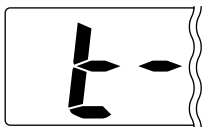

Tri-watch

◇ Operation beep

You can select silent operation by turning OFF the beep tones, or you can have confirmation beeps sound at the push of a key by turning ON the beep tones.



Beep tone ON (default)



Beep tone OFF

◇ LCD backlight

The LCD backlight brightness can be adjusted from 1 (dark) to 4 (bright), or turned OFF.

The LCD backlight is also adjustable holding down [SCAN] and pushing the [▲]/[▼] keys. (p. 9)

- “BACKLIGHT” scrolls in the channel comment display.



LCD backlight level 4 (default)



LCD backlight OFF

◇ LCD contrast

The LCD contrast can be adjustable in 4 levels. 1 is the lowest contrast, and 4 is the highest contrast.

- “CONTRAST” scrolls in the channel comment display.



LCD contrast level 3 (default)

◇ **AF level adjustment**

When turning the power ON, a beep is emitted to adjust the audio frequency level via [VOL].

Select the time period for the beep to 2, 5, 8, 10 (seconds) or OFF.



AF level 2 (default)



AF level OFF

◇ **Favorite channel**

Set the Favorite channel function ON or OFF.

The favorite channels are set by the TAG channel setting. (p. 11)

- “FAVORITE” scrolls in the channel comment display.

ON : Push the [▲]/[▼] keys on the microphone to sequentially select the favorite channels in the selected channel group.

OFF : Push the [▲]/[▼] keys on the microphone to sequentially select all channels in the selected channel group.



Favorite channel ON (default)



Favorite channel OFF

◇ **Remote ID**

Set a Remote ID number between 01 and 69.

The Remote ID is included in the sentence of the format for the Icom original NMEA.



Remote ID 14 (default)



Remote ID 69

■ Connections

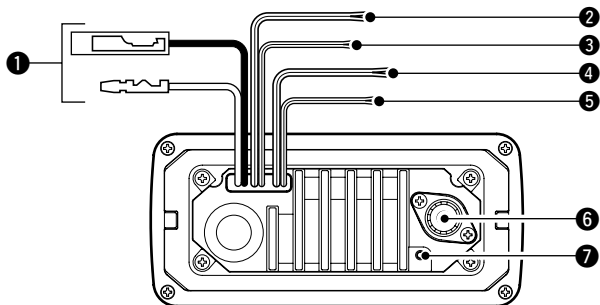

1 DC POWER CONNECTOR

Connect the supplied DC power cable from this connector to an external 12 V battery.

2 EXTERNAL SPEAKER LEAD (Yellow)

Connect an external speaker.

3 CLONE LEAD (Blue)

Connect a cloning cable.

4 NMEA IN LEAD (Red)

Connect a GPS receiver for position indication.

- A NMEA0183 ver. 2.0 or 3.01 (sentence formatters RMC, GGA, GNS, GLL) compatible GPS receiver is required. Ask your dealer about suitable GPS receivers.

5 NMEA OUT LEAD (White)

Connect a PC or navigation equipment (NMEA0183 ver. 3.01 sentence formatters DSC, DSE compatible) for plotting position data received from other ships.

CAUTION: After connecting the DC power cable, NMEA IN/OUT leads, external speaker lead and clone lead, cover the connector and leads with rubber vulcanizing tape, as shown below, to prevent water seeping into the transceiver.

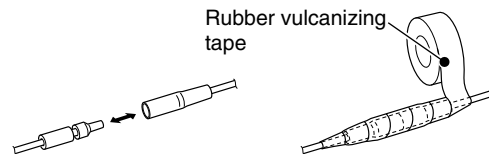

6 ANTENNA CONNECTOR

Connect a marine VHF antenna with a PL-259 connector to the transceiver.

CAUTION: Transmitting without an antenna may damage the transceiver.

7 GROUND TERMINAL

Connect this terminal to a vessel ground to prevent electrical shocks and interference from other equipment occurring. Use a PH M3 × 6 mm screw (not supplied).

◇ **Connect to the MA-500TR**

Connect the transceiver to the MA-500TR CLASS B AIS TRANSPONDER using the OPC-2014* NMEA CONNECTOR CABLE. After connecting, an Individual DSC call can be made to the AIS target using the transponder without entering the target's MMSI code.

* OPC-2014 is supplied with the MA-500TR

- NMEA IN LEAD (Red)
 Inner conductor: NMEA IN (+)
 Connects to lead 3 of OPC-2014.
 Outer conductor: NMEA IN (-)
 Connects to lead 2 of OPC-2014.

- NMEA OUT LEAD (White)
 Inner conductor: NMEA OUT (+)
 Connects to lead 5 of OPC-2014.
 Outer conductor: NMEA OUT (-)
 Connects to lead 4 of OPC-2014.

■ **Antenna**

A key element in the performance of any communication system is the antenna. Ask your dealer about antennas and the best place to mount them.

■ **Fuse replacement**

A fuse is installed in the supplied DC power cable. If the fuse blows, track down the source of the problem, have it repaired, and replace the damaged fuse with a new rated one.

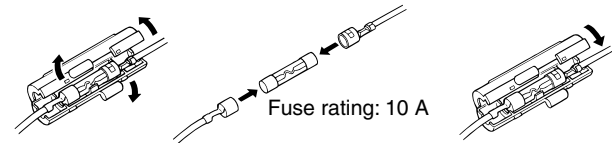

■ **Cleaning**

If the transceiver becomes dusty or dirty, wipe it clean with a soft, dry cloth.



DO NOT use harsh solvents such as benzine or alcohol, as they will damage transceiver surfaces.

■ Mounting the transceiver

◇ Using the supplied mounting bracket

The universal mounting bracket supplied with your transceiver allows overhead or dashboard mounting.

- Mount the transceiver securely with the two supplied screws (5 × 20) to a surface which is more than 10 mm ($1\frac{3}{32}$ inch) thick and can support more than 5 kg (11 lb).
- Mount the transceiver so that the face of the transceiver is at 90° to your line of sight when operating it.

/// **KEEP** the transceiver and microphone at least 1 meter (3.3 feet) away from your vessel's magnetic navigation compass.

/// **NOTE:** Check the installation angle; the function display may not be easy to read at some angles.

EXAMPLE

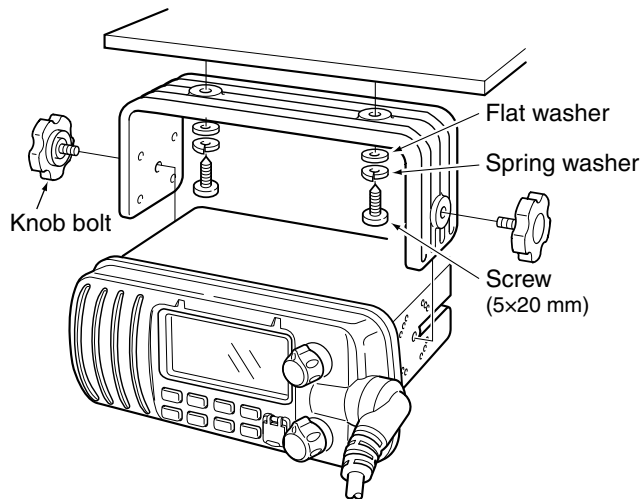

■ Optional MB-69 installation

An optional MB-69 FLUSH MOUNT is available for mounting the transceiver to a flat surface, such as an instrument panel.

KEEP the transceiver and microphone at least 1 meter (3.3 feet) away from your vessel's magnetic navigation compass.

- ① Using the template on page 55, carefully cut a hole into the instrument panel (or wherever you plan to mount the transceiver.)
- ② Slide the transceiver through the hole as shown below.

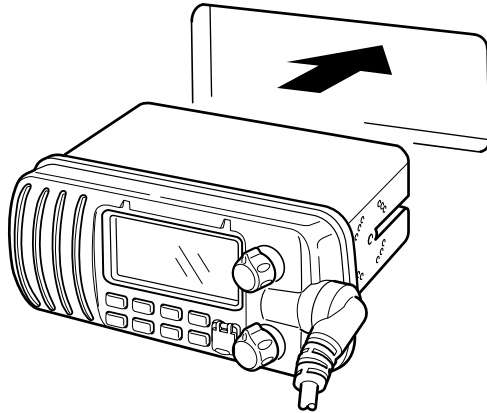

- ③ Attach the clamps on either side of the transceiver with two supplied bolts (5 × 8 mm).
 - Make sure that the clamps align parallel to the transceiver body.

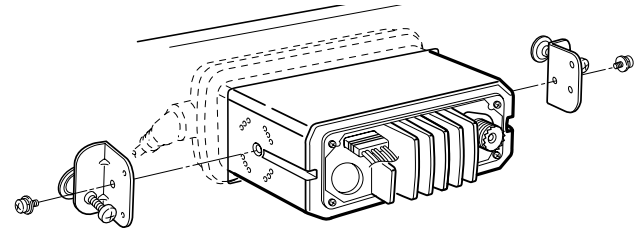

- ④ Tighten the end bolts on the clamps (rotate clockwise) so that the clamps press firmly against the inside of the instrument control panel.
- ⑤ Tighten the locking nuts (rotate counterclockwise) so that the transceiver is securely mounted in position, as shown below.
- ⑥ Connect the antenna and power cable, then return the instrument control panel to its original place.

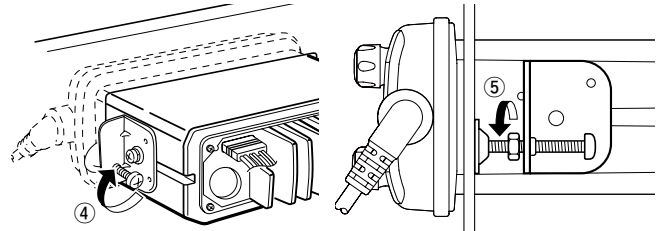

9

TROUBLESHOOTING

PROBLEM	POSSIBLE CAUSE	SOLUTION	REF.
The transceiver does not turn ON.	<ul style="list-style-type: none"> • Bad connection to the power supply. 	<ul style="list-style-type: none"> • Check the connection between the power supply and the transceiver. 	p. 48
No sound or weak sound comes from speaker.	<ul style="list-style-type: none"> • Squelch level is too high. • Volume level is too low. • Speaker has been exposed to water. 	<ul style="list-style-type: none"> • Set [SQL] to the threshold point. • Set [VOL] to a suitable level. • Remove the water with the AquaQuake function. 	p. 7 p. 7 p. 9
Transmitting is impossible, or high power can not be selected.	<ul style="list-style-type: none"> • Some channels are for low power or receive only. • The output power is set to low. 	<ul style="list-style-type: none"> • Change channels. • Push [HI/LO] on the microphone to select high power. 	pp. 5, 6 p. 7
Scan does not start.	<ul style="list-style-type: none"> • TAG channels are not programmed. 	<ul style="list-style-type: none"> • Set desired channels as TAG channels. 	p. 11
No beeps.	<ul style="list-style-type: none"> • Beep tones are turned OFF. 	<ul style="list-style-type: none"> • Turn the beep tone ON in the Set mode. 	p. 46
Distress calls cannot be transmitted.	<ul style="list-style-type: none"> • MMSI (DSC self ID) code is not programmed. 	<ul style="list-style-type: none"> • Program the MMSI (DSC self ID) code. 	p. 13

■ Specifications

◇ General

- Frequency coverage : Tx 156.025–157.425 MHz
Rx 156.050–163.275 MHz
- Mode : FM (16K0G3E),
DSC (16K0G2B)
- Channel spacing : 25 kHz
- Current drain (at 13.8 V) : TX high 5.5 A max.
Max. audio 1.5 A max.
- Power supply requirement: 13.8 V DC (negative ground)
- Frequency stability : ±10 ppm
- Operating temp. range : –20°C to +60°C; –4°F to +140°F
- Antenna impedance : 50 Ω nominal
- Input impedance (MIC) : 2 kΩ
- Output impedance (audio): 4 Ω
- Dimensions : 164(W) × 78(H) × 139.5(D) mm
(Projections not included) 6.46(W) × 3.07(H) × 5.49(D) in
- Weight : Approximately 1060 g; 2.4 lb

◇ Transmitter

- RF output power : 25 W (High)/1 W (Low)
- Modulation system : Variable reactance frequency modulation
- Max. frequency deviation : ±5.0 kHz
- Spurious emissions : Less than 70 dBc (High)
Less than 56 dBc (Low)
- Adjacent channel power : More than 70 dB
- Audio harmonic distortion : Less than 10%
(at 60% deviation)
- Residual modulation : More than 40 dB
- Audio frequency response: +1 to –3 dB of 6 dB/octave
range from 300 to 2500 Hz

◇ Receiver

- Receive system : Double conversion
superheterodyne
- Sensitivity (12 dB SINAD) : –120 dBm (typical)
- Squelch sensitivity : Less than –115 dBm
- Intermodulation rejection ratio : More than 70 dB
- Spurious response rejection ratio : More than 70 dB
- Adjacent channel selectivity : More than 70 dB
- Audio output power : 4.5 W typical
at 10% distortion
with a 4 Ω load

All stated specifications are subject to change without notice or obligation.

10 SPECIFICATIONS AND OPTION

◇ Dimensions

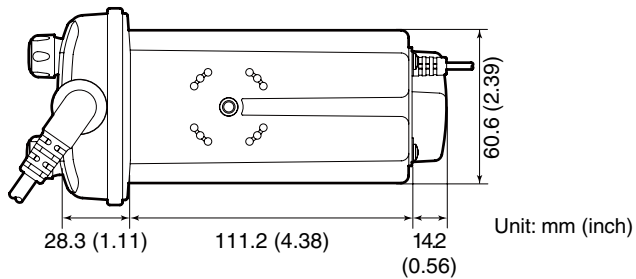
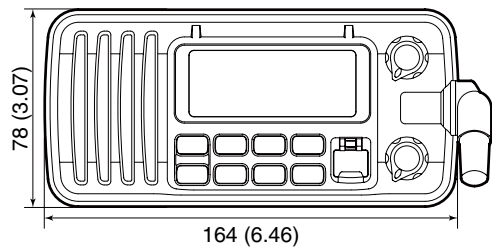
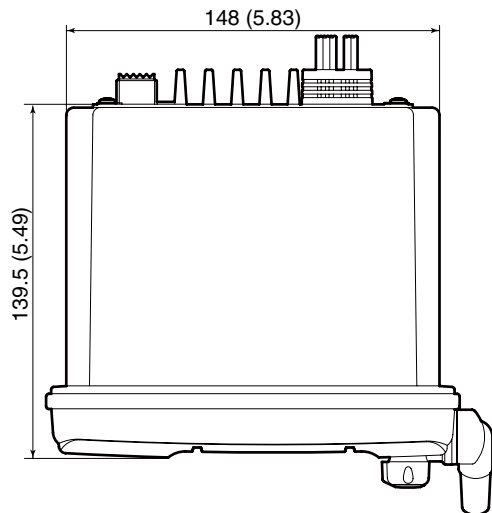

Unit: mm (inch)

■ Option

- **MB-69** FLUSH MOUNT KIT

For mounting the transceiver to a panel.

Approved Icom optional equipment is designed for optimal performance when used with an Icom transceiver. Icom is not responsible for the destruction or damage to an Icom transceiver in the event the Icom transceiver is used with equipment that is not manufactured or approved by Icom.

11 CHANNEL LIST

Channel number			Frequency (MHz)	
USA	INT	CAN	Transmit	Receive
	01	01	156.050	160.650
01A			156.050	156.050
	02	02	156.100	160.700
	03	03	156.150	160.750
03A			156.150	156.150
	04		156.200	160.800
		04A	156.200	156.200
	05		156.250	160.850
05A		05A	156.250	156.250
06	06	06	156.300	156.300
	07		156.350	160.950
07A		07A	156.350	156.350
08	08	08	156.400	156.400
09	09	09	156.450	156.450
10	10	10	156.500	156.500
11	11	11	156.550	156.550
12	12	12	156.600	156.600
13 ^{*2}	13	13 ^{*1}	156.650	156.650
14	14	14	156.700	156.700
15 ^{*2}	15 ^{*1}	15 ^{*1}	156.750	156.750
16	16	16	156.800	156.800
17 ^{*1}	17	17 ^{*1}	156.850	156.850
	18		156.900	161.500
18A		18A	156.900	156.900
	19		156.950	161.550
19A		19A	156.950	156.950
20	20	20 ^{*1}	157.000	161.600
20A			157.000	157.000

Channel number			Frequency (MHz)	
USA	INT	CAN	Transmit	Receive
	21	21	157.050	161.650
21A		21A	157.050	157.050
		21b	Rx only	161.650
	22		157.100	161.700
22A		22A	157.100	157.100
	23	23	157.150	161.750
23A			157.150	157.150
24	24	24	157.200	161.800
25	25	25	157.250	161.850
		25b	Rx only	161.850
26	26	26	157.300	161.900
27	27	27	157.350	161.950
28	28	28	157.400	162.000
		28b	Rx only	162.000
	60	60	156.025	160.625
	61		156.075	160.675
61A		61A	156.075	156.075
	62		156.125	160.725
		62A	156.125	156.125
	63		156.175	160.775
63A			156.175	156.175
	64	64	156.225	160.825
64A		64A	156.225	156.225
	65		156.275	160.875
65A	65A	65A	156.275	156.275
	66		156.325	160.925
66A	66A	66A ^{*1}	156.325	156.325
67 ^{*2}	67	67	156.375	156.375

Channel number			Frequency (MHz)	
USA	INT	CAN	Transmit	Receive
68	68	68	156.425	156.425
69	69	69	156.475	156.475
70 ^{*3}	70 ^{*3}	70 ^{*3}	156.525	156.525
71	71	71	156.575	156.575
72	72	72	156.625	156.625
73	73	73	156.675	156.675
74	74	74	156.725	156.725
75 ^{*1}	75 ^{*1}	75 ^{*1}	156.775	156.775
76 ^{*1}	76 ^{*1}	76 ^{*1}	156.825	156.825
77 ^{*1}	77	77 ^{*1}	156.875	156.875
	78		156.925	161.525
78A		78A	156.925	156.925
	79		156.975	161.575
79A		79A	156.975	156.975
	80		157.025	161.625
80A		80A	157.025	157.025
	81		157.075	161.675
81A		81A	157.075	157.075
	82		157.125	161.725
82A		82A	157.125	157.125
	83	83	157.175	161.775
83A		83A	157.175	157.175
		83b	Rx only	161.775
84	84	84	157.225	161.825
84A			157.225	157.225
85	85	85	157.275	161.875
85A			157.275	157.275
86	86	86	157.325	161.925

Channel number			Frequency (MHz)	
USA	INT	CAN	Transmit	Receive
86A			157.325	157.325
87	87	87	157.375	161.975
87A			157.375	157.375
88	88	88	157.425	162.025
88A			157.425	157.425

WX channel ^{*4}	Frequency (MHz)	
	Transmit	Receive
1	RX only	162.550
2	RX only	162.400
3	RX only	162.475
4	RX only	162.425
5	RX only	162.450
6	RX only	162.500
7	RX only	162.525
8	RX only	161.650
9	RX only	161.775
10	RX only	163.275

^{*1} Low power only. ^{*2} Momentary high power. ^{*3} DSC operation only.
^{*4} U.S.A. version transceiver only.

NOTE: Simplex channels, 3, 21, 23, 61, 64, 81, 82 and 83 **CANNOT** be lawfully used by the general public in U.S.A. waters.

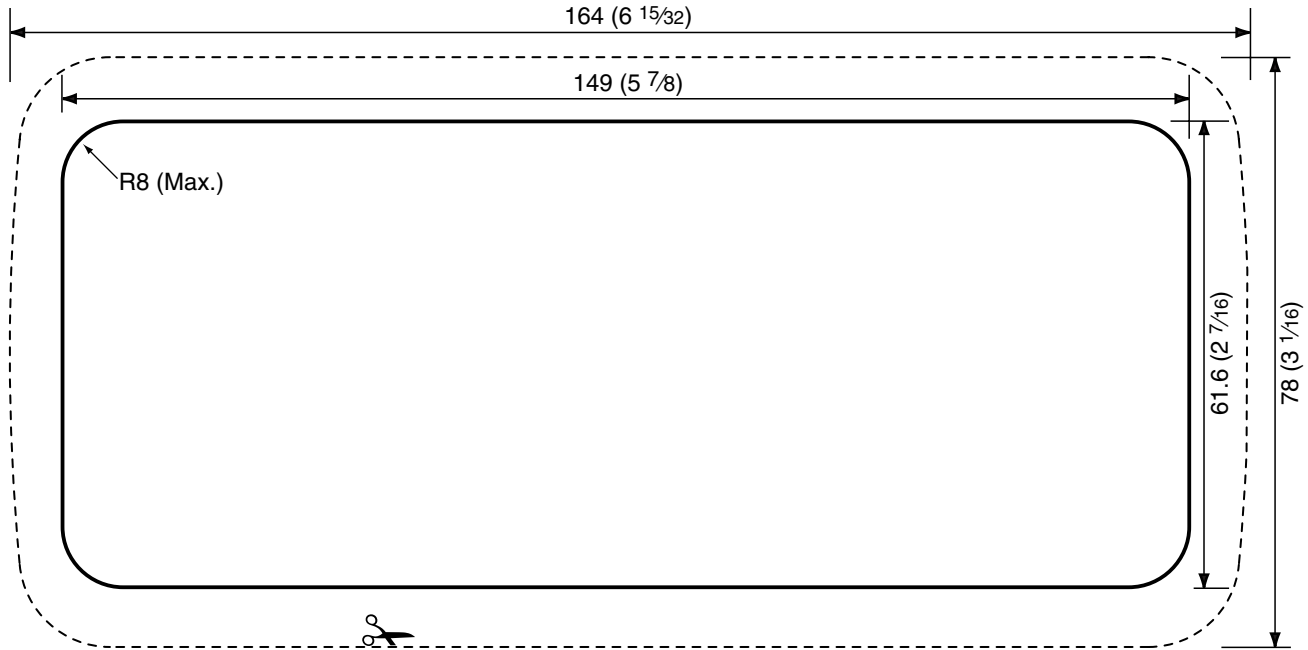

Cut here

- NOTE:** The solid line is the line to use when cutting into the dash/helm.
- The dotted line shows the outline of the IC-M412's front panel once the radio is fitted into the hole.
- DO NOT** follow the dotted line when making the hole in your dash/helm.

Count on us!

A-6868D-1US-①
Printed in Japan
© 2010–2012 Icom Inc.

Printed on recycled paper with soy ink.

Icom Inc.

1-1-32 Kamiminami, Hirano-ku, Osaka 547-0003, Japan