



INSTRUCTION MANUAL

VHF MARINE TRANSCEIVER IC-M411



Icom Inc.

FOREWORD

Thank you for purchasing this Icom product. The IC-M411 VHF MARINE TRANSCEIVER is designed and built with Icom's state of the art technology and craftsmanship. With proper care, this transceiver should provide you with years of trouble-free operation.

We want to take a couple of moments of your time to thank you for making the IC-M411 your radio of choice, and hope you agree with Icom's philosophy of "technology first." Many hours of research and development went into the design of your IC-M411.

◇ **FEATURES**

- *Advanced receiver performance*
- *Easy to hear speaker*
- *Built-in DSC meets Class D requirement*
- *Rugged waterproof construction*
- *Favorite channel function*
- *AquaQuake water draining function*

Icom, Icom Inc. and the ICOM logo are registered trademarks of Icom Incorporated (Japan) in the United States, the United Kingdom, Germany, France, Spain, Russia and/or other countries.

IMPORTANT

READ ALL INSTRUCTIONS carefully and completely before using the transceiver.

SAVE THIS INSTRUCTION MANUAL — This instruction manual contains important operating instructions for the IC-M411.

EXPLICIT DEFINITIONS

WORD	DEFINITION
⚠ WARNING!	Personal injury, fire hazard or electric shock may occur.
CAUTION	Equipment damage may occur.
NOTE	Recommended for optimum use. No risk of personal injury, fire or electric shock.

CLEAN THE TRANSCEIVER AND MICROPHONE THOROUGHLY WITH FRESH WATER after exposure to water including salt water, otherwise, the keys and switches may become inoperable due to salt crystallization.

IN CASE OF EMERGENCY

If your vessel requires assistance, contact other vessels and the Coast Guard by sending a Distress call on Channel 16.

USING CHANNEL 16

DISTRESS CALL PROCEDURE

1. "MAYDAY MAYDAY MAYDAY"
2. "THIS IS" (name of vessel)
3. Your call sign or other indication of the vessel (AND 9-digit DSC ID if you have one).
4. "LOCATED AT" (your position)
5. The nature of the distress and assistance required.
6. Any other information which might facilitate the rescue.

Or, transmit your Distress call using digital selective calling on Channel 70.

USING DIGITAL SELECTIVE CALLING (Ch 70)

DISTRESS CALL PROCEDURE

1. While lifting up the key cover, push and hold **[DISTRESS]** for 5 sec. until you hear 5 short beeps change to one long beep.
2. Wait for an acknowledgment on Channel 70 from a coast station.
 - After the acknowledgement is received, Channel 16 is automatically selected.
3. Push and hold **[PTT]**, then transmit the appropriate information as listed above.

INSTALLATION NOTE

The installation of this equipment should be made in such a manner as to respect the EC recommended electromagnetic field exposure limits (1999/519/EC).



The maximum RF power available from this device is 25 watts. The antenna should be installed as high as possible for maximum efficiency and that this installation height should be at least 5 meters above ground (or accessible) level. In the case where an antenna cannot be installed at a reasonable height, then the transmitter should neither be continuously operated for long periods if any person is within 5 meters of the antenna, nor operated at all if any person is touching the antenna.

In all cases any possible risk depends on the transmitter being activated for long periods. (Actual recommendation limits are specified as an average of 6 minutes) Normally the transmitter is not active for long periods of time. Some radio licenses will require that a timer circuit automatically cuts the transmitter after 1–2 minutes etc.

Similarly some types of transmitter, SSB, CW, AM, etc. have a lower 'average' output power and the perceived risk is even lower.

DOC

CE versions of the IC-M411 which display the “CE” symbol on the serial number seal, comply with the essential requirements of the European Radio and Telecommunication Terminal Directive 1999/5/EC. This warning symbol indicates that this equipment operates in non-harmonised frequency bands and/or may be subject to licensing conditions in the country of use. Be sure to check that you have the correct version of this radio or the correct programming of this radio, to comply with national licensing requirement.

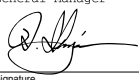
	DECLARATION OF CONFORMITY												
<p>We Icom Inc. Japan 1-1-32, Kamiminami, Hirano-ku Osaka 547-0003, Japan</p> <p>Declare on our sole responsibility that this equipment complies with the essential requirements of the Radio and Telecommunications Terminal Equipment Directive, 1999/5/EC, and that any applicable Essential Test Suite measurements have been performed.</p> <p>Kind of equipment: VHF MARINE TRANSCEIVER</p> <p>Type-designation: IC-M411</p> <p>Version (where applicable):</p> <p>This compliances is based on conformity with the following harmonised standards, specifications or documents:</p> <table border="0"> <tr> <td>i) EN 301 025-2</td> <td>V1.2.1 (2004-09)</td> </tr> <tr> <td>ii) EN 301 025-3</td> <td>V1.2.1 (2004-09)</td> </tr> <tr> <td>iii) EN 60945</td> <td>2002</td> </tr> <tr> <td>iv) EN 60550-1</td> <td>2001</td> </tr> <tr> <td>v) EN 300 698-2</td> <td>V1.1.1 (2000-08)</td> </tr> <tr> <td>vi) EN 300 698-3</td> <td>V1.1.1 (2001-05)</td> </tr> </table>	i) EN 301 025-2	V1.2.1 (2004-09)	ii) EN 301 025-3	V1.2.1 (2004-09)	iii) EN 60945	2002	iv) EN 60550-1	2001	v) EN 300 698-2	V1.1.1 (2000-08)	vi) EN 300 698-3	V1.1.1 (2001-05)	<p>CE 0560 </p> <p><small>Düsseldorf 26th Sep. 2007</small> Place and date of issue</p> <p><small>Icom (Europe) GmbH Himmelsteierstraße 100 D-40225 Düsseldorf</small> Authorized representative name</p> <p>H. Ikegami General Manager</p>  Signature
i) EN 301 025-2	V1.2.1 (2004-09)												
ii) EN 301 025-3	V1.2.1 (2004-09)												
iii) EN 60945	2002												
iv) EN 60550-1	2001												
v) EN 300 698-2	V1.1.1 (2000-08)												
vi) EN 300 698-3	V1.1.1 (2001-05)												
<p>Icom Inc.</p>													

• List of Country codes (ISO 3166-1)

	Country	Codes		Country	Codes
1	Austria	AT	18	Liechtenstein	LI
2	Belgium	BE	19	Lithuania	LT
3	Bulgaria	BG	20	Luxembourg	LU
4	Croatia	HR	21	Malta	MT
5	Czech Republic	CZ	22	Netherlands	NL
6	Cyprus	CY	23	Norway	NO
7	Denmark	DK	24	Poland	PL
8	Estonia	EE	25	Portugal	PT
9	Finland	FI	26	Romania	RO
10	France	FR	27	Slovakia	SK
11	Germany	DE	28	Slovenia	SI
12	Greece	GR	29	Spain	ES
13	Hungary	HU	30	Sweden	SE
14	Iceland	IS	31	Switzerland	CH
15	Ireland	IE	32	Turkey	TR
16	Italy	IT	33	United Kingdom	GB
17	Latvia	LV			

TABLE OF CONTENTS

FOREWORD	i	6 DSC OPERATION	13–40
IMPORTANT	i	■ MMSI code programming	13
EXPLICIT DEFINITIONS	i	■ DSC address ID	14
IN CASE OF EMERGENCY	ii	■ Position and time programming	17
INSTALLATION NOTE	ii	■ Position indication	18
DOC	iii	■ Distress call	18
TABLE OF CONTENTS	iv	■ Transmitting DSC calls	21
PRECAUTIONS	v	■ Receiving DSC calls	34
1 OPERATING RULES	1	■ Received messages	38
2 PANEL DESCRIPTION	2–4	■ Automatic acknowledgement	40
■ Front panel	2	■ Offset time	40
■ Microphone	3	7 SET MODE	41–43
■ Function display	4	■ Set mode programming	41
3 BASIC OPERATION	5–9	■ Set mode items	42
■ Channel selection	5	8 CONNECTIONS AND MAINTENANCE	44–47
■ Receiving and transmitting	7	■ Connections	44
■ Call channel programming	8	■ Antenna	45
■ Channel comments	8	■ Fuse replacement	45
■ Microphone Lock function	9	■ Cleaning	45
■ Display backlight	9	■ Supplied accessories	45
■ AquaQuake water draining function	9	■ Mounting the transceiver	46
4 SCAN OPERATION	10–11	■ Optional MB-69 installation	47
■ Scan types	10	9 TROUBLESHOOTING	48
■ Setting TAG channels	11	10 SPECIFICATIONS AND OPTION	49–51
■ Starting a scan	11	■ Specifications	49
5 DUALWATCH/TRI-WATCH	12	■ Option	51
■ Description	12	11 CHANNEL LIST	52–53
■ Operation	12	12 TEMPLATE	55

PRECAUTIONS

⚠ WARNING! NEVER connect the transceiver to an AC outlet. This may pose a fire hazard or result in an electric shock.

NEVER connect the transceiver to a power source of more than 16 V DC or use reverse polarity. This will ruin the transceiver.

NEVER cut the DC power cable between the DC plug at the back of the transceiver and fuse holder. If an incorrect connection is made after cutting, the transceiver may be damaged.

NEVER place the transceiver where normal operation of the vessel may be hindered or where it could cause bodily injury.

KEEP the transceiver at least 1 m away from the ship's navigation compass.

DO NOT use or place the transceiver in areas with temperatures below -20°C or above $+60^{\circ}\text{C}$ or, in areas subject to direct sunlight, such as the dashboard.

AVOID the use of chemical agents such as benzine or alcohol when cleaning, as they may damage the transceiver surfaces. If the transceiver becomes dusty or dirty, wipe it clean with a soft, dry cloth.

BE CAREFUL! The transceiver rear panel will become hot when operating continuously for long periods. Place the transceiver in a secure place to avoid inadvertent use by children.

BE CAREFUL! The transceiver employs waterproof construction, which corresponds to IPX7 of the international standard IEC 60529 (2001). However, once the transceiver has been dropped, waterproofing cannot be guaranteed due to the fact that the case may be cracked, or the waterproof seal damaged, etc.

Icom optional equipment is designed for optimal performance when used with this transceiver. We are not responsible for the transceiver being damaged or any accident caused when using non-Icom optional equipment.

◇ PRIORITIES

- Read all rules and regulations pertaining to priorities and keep an up-to-date copy handy. Safety and Distress calls take priority over all others.
- You must monitor Channel 16 when you are not operating on another channel.
- False or fraudulent distress signals are prohibited and punishable by law.

◇ PRIVACY

- Information overheard but not intended for you cannot lawfully be used in any way.
- Indecent or profane language is prohibited.

◇ RADIO LICENSES

(1) SHIP STATION LICENSE

You must have a current radio station license before using the transceiver. It is unlawful to operate a ship station which is not licensed.

Inquire through your dealer or the appropriate government agency for a Ship-Radiotelephone license application. This government-issued license states the call sign which is your craft's identification for radio purposes.

(2) OPERATOR'S LICENSE

A Restricted Radiotelephone Operator Permit is the license most often held by small vessel radio operators when a radio is not required for safety purposes.

The Restricted Radiotelephone Operator Permit must be posted or kept with the operator. Only a licensed radio operator may operate a transceiver.

However, non-licensed individuals may talk over a transceiver if a licensed operator starts, supervises, ends the call and makes the necessary log entries.

Keep a copy of the current government rules and regulations handy.

■ Front panel

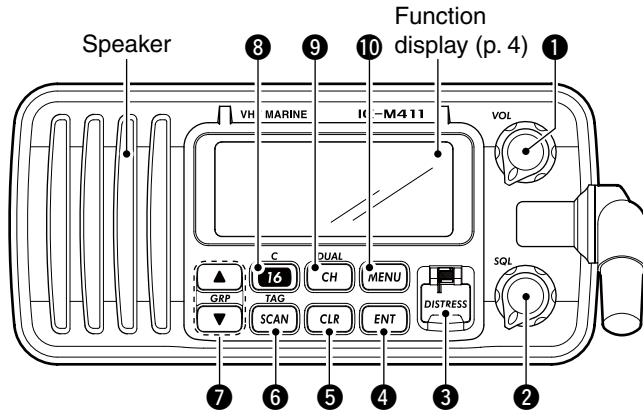

1 POWER/VOLUME CONTROL [VOL]

- ➔ Rotate to turn the transceiver power ON or OFF.
- ➔ Rotate to adjust the audio level.

2 SQUELCH CONTROL [SQL] (p. 7)

Rotate to set the squelch threshold level.

3 DISTRESS KEY [DISTRESS] (p. 18)

Push and hold for 3 sec. to transmit a distress call.

4 ENTER KEY [ENT]

Sets the DSC menu, a channel comment, etc. when pushed.

5 CLEAR KEY [CLR]

Push to cancel the entered function and exits the condition when pushed.

6 SCAN/TAG CHANNEL KEY [SCAN•TAG] (p. 11)

- ➔ Push to start and stop the normal or priority scan when tag channels are programmed.
- ➔ Push and hold for 1 sec. to set or clear the displayed channel as a tag (scanned) channel.
- ➔ While pushing [HI/LO] located on the microphone, push and hold for 3 sec. to set or clear all tag channels in the selected channel group.

7 CHANNEL UP/DOWN KEYS [▲]/[▼]•[GRP]

- ➔ Push to select the operating channels, Set mode settings, DSC menu items, etc. (pgs. 5, 6, 13, 41)
- ➔ Push both keys to select a channel group in sequence. (p. 6)
 - EUR version has International channels only and this function is not available.
- ➔ Push to select the desired digit or character. (pgs. 8, 13, 14, 17)
- ➔ While pushing [SCAN•TAG], push to adjust the brightness of the LCD and key backlight. (p. 9)
- ➔ While pushing and holding both keys, turn power ON to activates the AquaQuake function. (p. 9)

- 8 CHANNEL 16/CALL CHANNEL KEY [16•C]**

 - Push to select Channel 16. (p. 5)
 - Push and hold for 1 sec. to select call channel. (p. 5)
 - “CALL” appears when call channel is selected.
 - Push and hold for 3 sec. to enter the call channel programming condition when the call channel is selected. (p. 8)
 - While pushing [CH•DUAL], push to enter the channel comment programming condition. (p. 8)
 - While turning power ON, push to enter set mode. (p. 41)
- 9 CHANNEL/DUALWATCH/TRI-WATCH KEY [CH•DUAL]**

 - Push to select the regular channel. (pgs. 5, 6)
 - Push and hold for 1 sec. to start dualwatch or tri-watch. (p. 12)
 - Push to stop dualwatch or tri-watch when either is activated. (p. 12)
- 10 DSC MENU KEY [MENU] (p. 13)**

Push to toggle the DSC menu ON or OFF.

Microphone

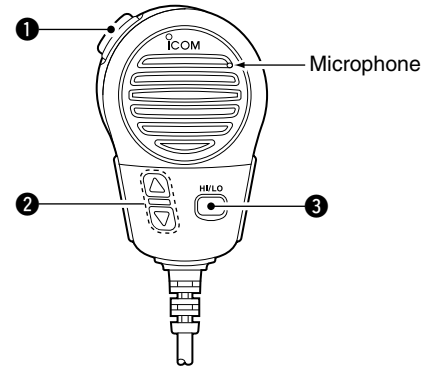

- 1 PTT SWITCH [PTT]**

Push and hold to transmit; release to receive. (p. 7)
- 2 CHANNEL UP/DOWN KEYS [▲]/[▼]**

 - Push to select the operating channels, Set mode settings, DSC menu items, etc. (pgs. 5, 6, 13, 41)
 - Checks TAG channels, changes scanning direction or resumes the scan manually during scan. (p. 11)
 - Push to select the desired digit or character. (pgs. 8, 13, 14, 17)
- 3 TRANSMIT POWER KEY [HI/LO]**

 - Push to toggle the output power high and low. (p. 7)
 - Some channels are set to low power only.
 - While pushing and holding [HI/LO], turn power ON to toggle the Microphone Lock function ON and OFF. (p. 9)

2 PANEL DESCRIPTION

■ Function display

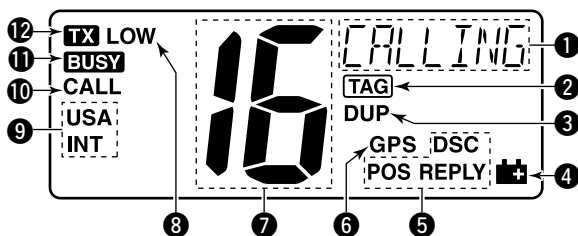

1 CHANNEL COMMENT INDICATOR

- 'Latitude,' 'Longitude' and UTC time data scroll in sequence.
- Channel comment appears and scrolls (if programmed) for about 10 sec. after the channel selection. (p. 8)
- "DSC" appears when DSC channel group is in use; "ATIS" appears when ATIS channel group is in use. (p. 6)
- "SCAN 16" appears during Priority scan; "SCAN" appears during Normal scan. (p. 11)
- "DW 16" appears during Dualwatch; "TW 16" appears during Tri-watch. (p. 12)
- In Set mode, indicates and scrolls the selected item. (p. 41)

2 TAG CHANNEL INDICATOR (p. 11)

Appears when a TAG channel is selected.

3 DUPLEX INDICATOR (p. 6)

Appears when a duplex channel is selected.

4 LOW BATTERY INDICATOR

Appears when the battery voltage drops to approx. 10 V DC or below.

5 DSC INDICATOR

Indicates the DSC status.

- "DSC" appears when a DSC call is received. (pgs. 23, 34)
- "POS REPLY" appears when a Position Reply call is received. (p. 37)

6 GPS INDICATOR

- Appears while valid position data is received.
- Blinks when invalid position data is received.
- Disappears when no GPS receiver is connected.

7 CHANNEL NUMBER READOUT

- Indicates the selected operating channel number.
 - "A" appears when a simplex channel is selected.
- In Set mode, indicates the selected condition. (p. 41)

8 LOW POWER INDICATOR (p. 7)

Appears when low power is selected.

9 CHANNEL GROUP INDICATOR (p. 6)

Indicates whether an International "INT" or U.S.A. "USA" channel is in use. (Depends on version)

10 CALL CHANNEL INDICATOR (p. 5)

Appears when the call channel is selected.

11 BUSY INDICATOR (p. 7)

Appears when receiving a signal or when the squelch opens.

12 TRANSMIT INDICATOR (p. 7)

Appears while transmitting.

■ Channel selection

◇ Channel 16

Channel 16 is the distress and safety channel. It is used for establishing initial contact with a station and for emergency communications. Channel 16 is monitored during both Du-alwatch and Tri-watch. While standing by, you must monitor Channel 16.

- ➔ Push **[16•C]** momentarily to select Channel 16.
- ➔ Push **[CH•DUAL]** to return to the condition before selecting Channel 16, or push **[▲]** or **[▼]** to select an operating channel.



Convenient!

When the Favorite channel function is turned ON (p. 43), **[▲]**/**[▼]** keys on the microphone select the favorite channels in the selected channel group in sequence when pushed.

- The favorite channels are set by the TAG channel setting. (p. 11)

◇ Call channel

Each regular channel group has a separate leisure-use call channel. The call channel is monitored during Tri-watch. The call channels can be programmed (p. 8) and are used to store your most often used channel in each channel group for quick recall.

- ➔ Push and hold **[16•C]** for 1 sec. to select the call channel of the selected channel group.
 - “CALL” and call channel number appear.
 - Each channel group may have an independent call channel after programming a call channel. (p. 8)
- ➔ Push **[CH•DUAL]** to return to the condition before selecting call channel, or push **[▲]** or **[▼]** to select an operating channel.

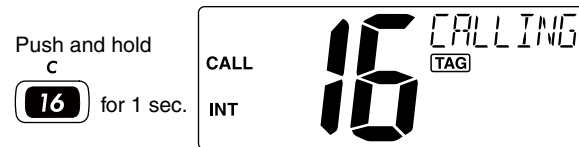

3 BASIC OPERATION

◇ International channels

There are pre-programmed 57 (EUR version,) 59 (U.K. version,) 58 (Holland version) or 56 (FRG version) International channels for the IC-M411.

- ① Push **[CH•DUAL]** to select a regular channel.
- ② Push both **[▲]** and **[▼]** on the transceiver to change the channel group, if necessary.
 - EUR version has International channels only and this function is not available.
- ③ Push **[▲]** or **[▼]** to select a channel.
 - “**DUP**” appears for duplex channels.

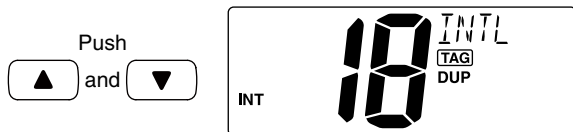

◇ U.S.A. channels (U.K. version only)

For U.K. version, there are pre-programmed 61 U.S.A. channels in addition to 59 International channels.

- ① Push **[CH•DUAL]** to select a regular channel.
- ② Push both **[▲]** and **[▼]** on the transceiver to change the channel group, if necessary.
 - International and U.S.A. channels can be selected in sequence.
- ③ Push **[▲]** or **[▼]** to select a channel.
 - “**DUP**” appears for duplex channels.



◇ ATIS and DSC channels

(Holland and FRG versions only)

For Holland and FRG version, there are pre-programmed 57 ATIS and 57 DSC* channels in addition to 58 (Holland version) or 56 (FRG version) International channels.

- ① Push **[CH•DUAL]** to select a regular channel.
- ② Push both **[▲]** and **[▼]** on the transceiver to change the channel group, if necessary.
 - International, ATIS and DSC* channels can be selected in sequence.
- ③ Push **[▲]** or **[▼]** to select a channel.
 - “**DUP**” appears for duplex channels.

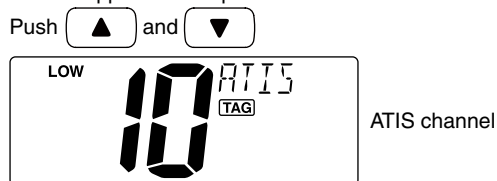

*FRG version only

■ Receiving and transmitting

CAUTION: Transmitting without an antenna may damage the transceiver.

- ① Rotate **[VOL]** to turn power ON.
- ② Set the audio and squelch levels.
 - ➔ Rotate **[SQL]** fully counterclockwise in advance.
 - ➔ Rotate **[VOL]** to adjust the audio output level.
 - ➔ Rotate **[SQL]** clockwise until the noise disappears.
 - While in the DSC operation, please make sure you set the squelch correctly.
- ③ Push both **[▲]** and **[▼]** on the transceiver to change the channel group. (p. 6)
- ④ Push **[▲]** or **[▼]** to select the desired channel. (pgs. 5, 6, 52)
 - When receiving a signal, “**BUSY**” appears and audio is emitted from the speaker.
 - Further adjustment of **[VOL]** may be necessary.
- ⑤ Push **[HI/LO]** on the microphone to select the output power if necessary.
 - “**LOW**” appears when low power is selected.
 - Choose low power for short range communications, choose high power for longer distance communications.
 - Some channels are for low power only.
- ⑥ Push and hold **[PTT]** to transmit, then speak into the microphone.
 - “**TX**” appears.
 - Channel 70 cannot be used for transmission other than DSC.
- ⑦ Release **[PTT]** to receive.

IMPORTANT: To maximize the readability of your transmitted signal, pause a few sec. after pushing **[PTT]**, hold the microphone 5 to 10 cm from your mouth and speak at a normal voice level.

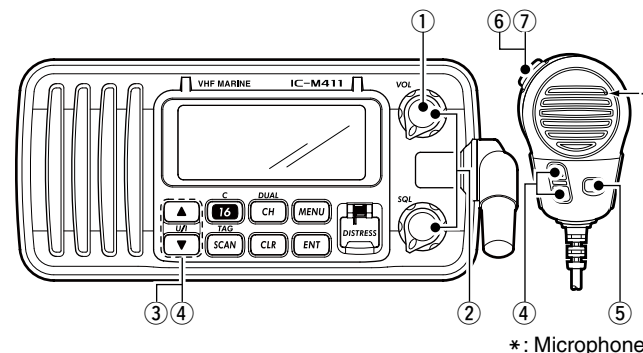

✓ NOTE for TOT (Time-out Timer) function

The TOT function inhibits continuous transmission over a preset time period after the transmission starts. A beep sounds 10 sec. before the TOT function activates, to indicate the transmission will be shut down and “TOT” appears on the channel comment indicator. Transmission is not possible for 10 sec. after this transmission shut down.

3 BASIC OPERATION

■ Call channel programming

You can program the call channel with your most often-used channels in each channel group for quick recall.

- ① Push both **[▲]** and **[▼]** on the transceiver one or more times to select the desired channel group (INT, USA, ATIS or DSC) to be programmed.
- ② Push and hold **[16•C]** for 1 sec. to select the call channel of the selected channel group.
 - "CALL" and call channel number appear.
- ③ Push and hold **[16•C]** again for 3 sec. (until a long beep changes to 2 short beeps) to enter the call channel programming condition.
 - Channel number starts blinking.
- ④ Push **[▲]** or **[▼]** to select the desired channel.
- ⑤ Push **[16•C]** to program the displayed channel as the call channel.
 - Push **[CLR]** to cancel.
 - The channel number stops blinking.

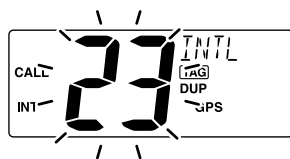

■ Channel comments

Memory channels can be labeled with alphanumeric comments of up to 10 characters each for easy channel recognition.

Comment is indicated at the channel comment indicator for about 10 sec. after the channel selection, and the comment, more than 7 characters long, automatically scrolls.

Capital letters, small letters (except f, j, k, p, s, v, x, z), 0 to 9, some symbols (= * + - . /) and space can be used.

- ① Select the desired channel.
 - Cancel Dualwatch, Tri-watch or Scan in advance.
- ② While pushing **[CH•DUAL]**, push **[16•C]** to edit the channel comment.
 - A cursor and the first character start blinking alternately.
- ③ Select the desired character by pushing **[▲]** or **[▼]**.
 - Push **[CH•DUAL]** or **[16•C]** to move the cursor forward or backward, respectively.
- ④ Repeat step ③ to input all characters.
- ⑤ Push **[ENT]** to input and set the comment.
 - Push **[CLR]** to cancel and exit the condition.
 - The cursor and the character stop blinking.
- ⑥ Repeat steps ① to ⑤ to program other channel comments, if desired.



■ Microphone Lock function

The Microphone Lock function electrically locks [▲]/[▼] on the supplied microphone. This prevents accidental channel changes and function access.

- ➔ While pushing [HI/LO] on the microphone, turn power ON to toggle the Microphone Lock function ON and OFF.

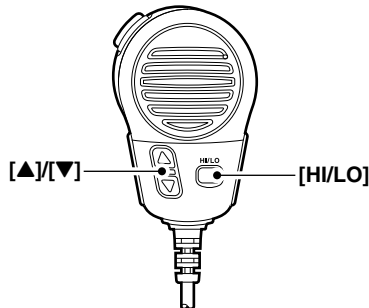

■ Display backlight

The function display and keys can be backlit for better visibility under low light conditions.

Display backlight is also adjustable via the Set mode. (p. 43)

- ➔ While pushing [SCAN•TAG], push [▲] or [▼] to adjust the brightness of the LCD and key backlight.
 - The backlight is adjustable in 4 levels and OFF.

■ AquaQuake water draining function

The IC-M411 uses a technology to clear water away from the speaker grill: AquaQuake. AquaQuake helps drain water away from the speaker housing (water that might otherwise muffle the sound coming from the speaker). The IC-M411 emits a vibrating noise when this function is being used.

- ➔ While pushing and holding both [▲] and [▼] on the transceiver, turn power ON.
 - A low beep tone sounds while [▲] and [▼] keys are pushed and held to drain water, regardless of [VOL] control setting.
 - The transceiver never accepts a key operation while the Aqua-Quake function is activated.

■ Scan types

Scanning is an efficient way to locate signals quickly over a wide frequency range. The transceiver has Priority scan and Normal scan.

Set the TAG channels (scanned channel) before scanning. Clear the TAG channels which inconveniently stop scanning, such as those for digital communication use. (Refer to right page for details.)

/// Choose Priority or Normal scan in Set mode. (p. 42)

PRIORITY SCAN

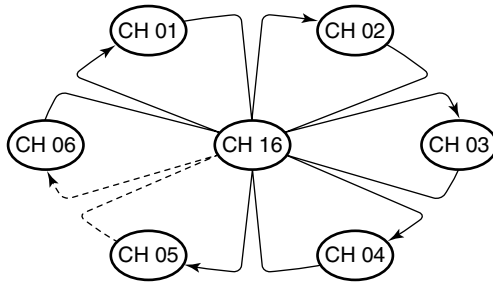

Priority scan searches through all TAG channels in sequence while monitoring Channel 16. When a signal is detected on Channel 16, scan pauses until the signal disappears; when a signal is detected on a channel other than Channel 16, scan becomes Dualwatch until the signal disappears.

NORMAL SCAN

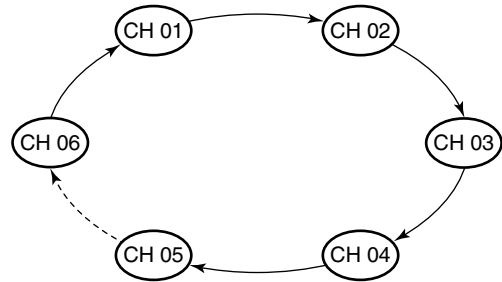

Normal scan, like Priority scan, searches through all TAG channels in sequence. However, unlike Priority scan, Channel 16 is not checked unless Channel 16 is set as a TAG channel.

■ Setting TAG channels

For more efficient scanning, add the desired channels as TAG channels or clear the TAG for unwanted channels. Channels that are not tagged will be skipped during scanning. TAG channels can be assigned to each channel group (INT, USA, ATIS or DSC) independently.

- ① Push both [▲] and [▼] to select the desired channel group, if desired.
- ② Select the desired channel to be set as a TAG channel.
- ③ Push and hold [SCAN•TAG] for 1 sec. to set the displayed channel as a TAG channel.
 - “TAG” appears in the display.
- ④ To cancel the TAG channel setting, repeat step ③.
 - “TAG” disappears.

✓ Clearing (or setting) all tagged channels

While pushing [HI/LO] on the microphone, push and hold [SCAN•TAG] for 3 sec. (until a long beep changes to 2 short beeps) to clear all TAG channels in the channel group.

- Repeat above procedure to set all TAG channels.

■ Starting a scan

Set scan type (Priority or Normal scan) and scan resume timer in advance, using Set mode. (p. 42)

- ① Push both [▲] and [▼] to select the desired channel group, if desired.
- ② Set TAG channels as described at left.
- ③ Make sure the squelch is closed to start a scan.
- ④ Push [SCAN•TAG] to start Priority or Normal scan.
 - “SCAN” blinks at the channel comment indicator during scanning. (During Priority scan, “16” appears beside the blinking “SCAN” indication.)
 - A beep tone sounds and “16” blinks at the channel comment indicator when a signal is received on Channel 16 during Priority scan.
 - When a signal is detected, scan pauses until the signal disappears or resumes after pausing 5 sec. according to Set mode setting. (Channel 16 is still monitored during Priority scan.)
 - Push [▲] or [▼] to check the scanning TAG channels, to change the scanning direction or resume the scan manually.
- ⑤ To stop the scan, repeat step ④.

[Example]: Starting a Normal scan.

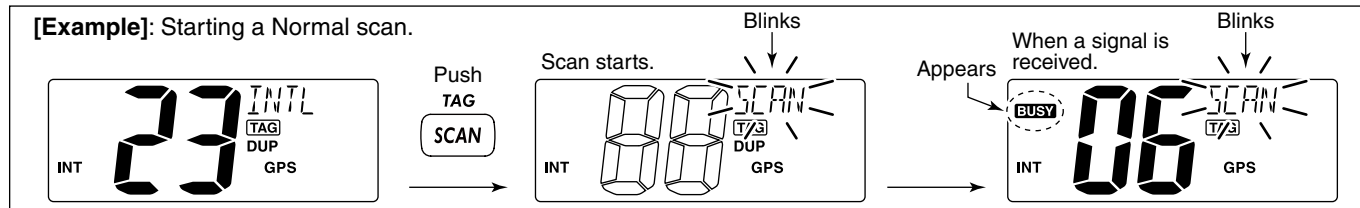

■ Description

Dualwatch monitors Channel 16 while you are receiving on another channel; Tri-watch monitors Channel 16 and the call channel while receiving another channel. Dualwatch/Tri-watch is convenient for monitoring Channel 16 when you are operating on another channel.

DUALWATCH/TRI-WATCH SIMULATION

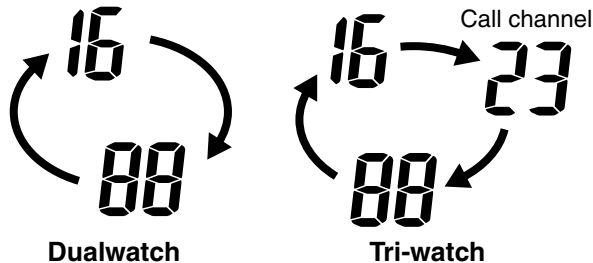

- If a signal is received on Channel 16, Dualwatch/Tri-watch pauses on Channel 16 until the signal disappears.
- If a signal is received on the call channel during Tri-watch, Tri-watch becomes Dualwatch until the signal disappears.
- To transmit on the selected channel during Dualwatch/Tri-watch, push and hold [PTT].

■ Operation

- ① Select Dualwatch or Tri-watch in Set mode. (p. 42)
- ② Push [▲] or [▼] to select the desired channel.
- ③ Push and hold [CH•DUAL] for 1 sec. to start Dualwatch or Tri-watch.
 - “DW” blinks during Dualwatch; “TW” blinks during Tri-watch.
 - A beep tone sounds and “16” blinks when a signal is received on Channel 16.
- ④ To cancel Dualwatch/Tri-watch, push [CH•DUAL] again.

[Example]: Operating Tri-watch on INT Channel 25

- ① Tri-watch starts.



- ② Signal is received on call channel.



- ④ Tri-watch resumes after the signal disappears.



- ③ Signal is received on Channel 16 takes priority.



■ MMSI code programming

The 9-digit MMSI (Maritime Mobile Service Identity: DSC self ID) code can be programmed at power ON.

This code programming can be performed only once. After the code programming, it can be changed only by your dealer or distributor.

- ① While pushing **[MENU]**, turn power ON to enter MMSI code programming condition.
 - Turn power OFF in advance.
- ② After the display appears, release **[MENU]**.
- ③ Push **[MENU]** to enter the DSC menu.
- ④ Push **[▲]** or **[▼]** to select “MMSI” and push **[ENT]**.
 - A cursor starts blinking.



- ⑤ Input the specified MMSI code by pushing **[▲]** or **[▼]**.
 - Push **[CH•DUAL]** or **[16•C]** to move the cursor forward or backward, respectively.
- ⑥ After inputting the 9-digit MMSI code, push **[ENT]**.
 - “CONFIRMATION” scrolls at the channel comment indicator.

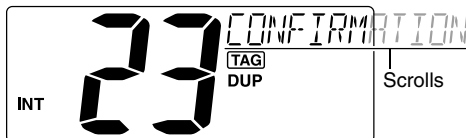

- ⑦ Push **[ENT]**, then input the same MMSI code as step ⑤ for the confirmation.
- ⑧ Push **[ENT]** to set the code.
 - Returns to the normal operation.
 - Push **[CLR]** to cancel and exit the condition.
 - If the different code is input, “INCORRECT” appears. Push **[ENT]** and try steps ⑤ to ⑦ again.

◇ MMSI code check

The 9-digit MMSI (DSC self ID) code can be checked.

- Push **[MENU]** for 1 sec. to display the 9-digit MMSI (DSC self ID) code.
 - The MMSI code is displayed and scrolls at the channel comment indicator.
 - When no MMSI code is programmed, “NO MMSI” appears and warning alarm sounds.

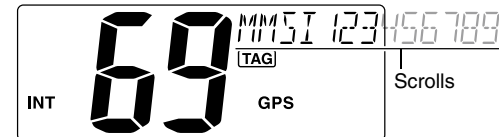

6 DSC OPERATION

■ DSC address ID

A total of 100 DSC address IDs (9-digit) can be programmed and named with up to 10 characters.

◇ Programming Address ID

- ① Push [MENU] to enter the DSC menu.
- ② Push [▲] or [▼] to select “ADDRESS,” push [ENT].



- ③ Push [▲] or [▼] to select “ADD INDV ID,” push [ENT].



- ④ Push [▲] or [▼] to set the 9-digit Individual ID, push [ENT].
 - Push [CH•DUAL] or [16•C] to move the cursor forward or backward, respectively.
 - Push [CLR] to cancel and exit the condition.



- ⑤ Push [▲] or [▼] to set up to a 10-character ID name.
 - Push [CH•DUAL] or [16•C] to move the cursor forward or backward, respectively.
 - Push [CLR] to cancel and exit the condition.



- ⑥ Push [ENT] to program and returns to the normal operation.

◇ **Deleting Address ID**

- ① Push [MENU] to enter the DSC menu.
- ② Push [▲] or [▼] to select “ADDRESS,” and push [ENT].



- ③ Push [▲] or [▼] to select “DEL INDV ID,” push [ENT].
 - When no address ID is programmed, “NO ID” is displayed.



- ④ Push [▲] or [▼] to select the desired ID name for deleting and push [ENT].
 - “READY” appears.



- ⑤ Push [ENT] to delete the selected address ID and returns to the normal operation.

◇ **Programming Group ID**

- ① Push [MENU] to enter the DSC menu.
- ② Push [▲] or [▼] to select “ADDRESS,” push [ENT].



- ③ Push [▲] or [▼] to select “ADD GROUP ID,” push [ENT].



- ④ Push [▲] or [▼] to set the 9-digit Group ID, push [ENT].
 - Push [CH•DUAL] or [16•C] to move the cursor forward or backward, respectively.
 - Push [CLR] to cancel and exit the condition.
- ⚡ 1st digit '0' is fixed for a Group ID.



☞ Continue to the next page

6 DSC OPERATION

- ⑤ Push [▲] or [▼] to set up to a 10-character ID name.
- Push [CH•DUAL] or [16•C] to move the cursor forward or backward, respectively.
 - Push [CLR] to cancel and exit the condition.



- ⑥ Push [ENT] to program and returns to the normal operation.

◇ Deleting Group ID

- ① Push [MENU] to enter the DSC menu.
- ② Push [▲] or [▼] to select “ADDRESS,” and push [ENT].



- ③ Push [▲] or [▼] to select “DEL GROUP ID,” push [ENT].
- When no group ID is programmed, “NO ID” is displayed.

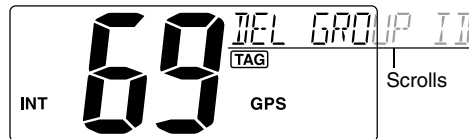

- ④ Push [▲] or [▼] to select the desired ID name for deleting and push [ENT].
- “READY” appears.



- ⑤ Push [ENT] to delete the selected group ID and returns to the normal operation.

■ Position and time programming

A distress call should include the ship's position and time data. If no GPS is connected, your position and UTC (Universal Time Coordinated) time should be input manually. They are included automatically when a GPS receiver (NMEA0183 ver. 2.0 or 3.01) is connected.

- ① Push **[MENU]** to enter the DSC menu.
- ② Push **[▲]** or **[▼]** to select "POSITION INPUT," and push **[ENT]**.



- ③ The position information appears. Set your latitude data using **[▲]** or **[▼]**. After setting the latitude data, push **[ENT]** to set your longitude data.
 - Push **[CH•DUAL]** or **[16•C]** to move the cursor forward or backward, respectively.
 - Push **[▲]** or **[▼]** to edit N; North latitude or S; South latitude when the cursor is on the 'N' or 'S' position, and W; West longitude or E; East longitude when the cursor is on the 'W' or 'E' position.
 - Push **[CLR]** to cancel and exit the condition.



- ④ After setting the longitude data, push **[ENT]** to set the current UTC time using **[▲]** or **[▼]**.
 - Push **[CH•DUAL]** or **[16•C]** to move the cursor forward or backward, respectively.
 - Push **[CLR]** to cancel and exit the condition.



- ⑤ Push **[ENT]** to program and returns to the normal operation.

Manually programmed position data will be held for 23.5 hours only. "??" may blink instead of position and time indications when the GPS data is invalid, or has not been manually updated after 4 hours.

6 DSC OPERATION

■ Position indication

When a GPS receiver (NMEA0183 ver. 2.0 or 3.01) is connected, the transceiver displays the current position data in seconds of accuracy.

A NMEA0183 ver. 2.0 or 3.01 (sentence formatters RMC, GGA, GNS, GLL) compatible GPS receiver is required. Ask your dealer about suitable GPS receivers.

- ‘Latitude,’ ‘Longitude’ and UTC time data scroll in sequence at the channel comment indicator.
 - Channel comment is indicated at the channel comment indicator for about 10 sec. after the channel selection.
- “NO POSITION” scrolls when no GPS is connected.

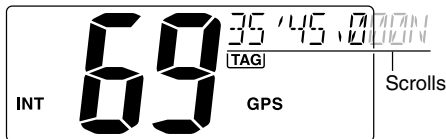

- When the connected GPS receiver is compatible with several sentence formatters, the order of input precedence is ‘RMC,’ ‘GGA,’ ‘GNS’ and ‘GLL.’
- “GPS” blinks when the GPS data is invalid.

■ Distress call

A Distress call should be transmitted, if in the opinion of the Master, the ship or a person is in distress and requires immediate assistance.

NEVER USE THE DISTRESS CALL WHEN YOUR SHIP OR A PERSON IS NOT IN AN EMERGENCY. A DISTRESS CALL CAN BE USED ONLY WHEN IMMEDIATE HELP IS NEEDED.

◇ Simple call

- ① Confirm no Distress call is being received.
- ② While lifting up the key cover, push and hold **[DISTRESS]** for 3 sec. to transmit the Distress call.
 - Emergency channel (Ch 70) is automatically selected and the Distress call is transmitted.
 - While pushing and holding **[DISTRESS]**, the key backlighting is blinking.



- ③ After transmitting the Distress call, the transceiver waits for an acknowledgment call on Ch16.
 - The Distress call is automatically transmitted every 3.5 to 4.5 minutes.
 - “DSC REPEAT” scrolls at the channel comment indicator.



- ④ After receiving the acknowledgment, reply using the microphone.
- “RCV DISTRESS ACK” scrolls at the channel comment indicator.

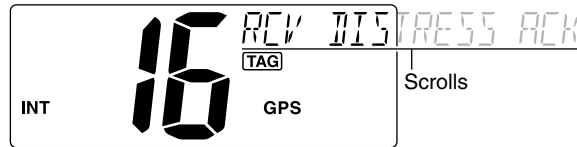

- ➔ A distress alert contains;
 - Kinds of distress: Undesignated distress
 - Position data : Latest GPS or manual input position data held for 23.5 hrs. or until the power is turned OFF.
- ➔ The Distress call is repeated every 3.5–4.5 min., until receiving an ‘acknowledgement.’ (‘Call repeat’ mode)
 - “RE-TRANSMISSION” is displayed while transmission.
- ➔ Push **[DISTRESS]** to transmit a renewed Distress call, if desired.
- ➔ Push **[CLR]** to transmit a the ‘Cancel ACK’ call to cancel the ‘Call repeat’ mode.
 - “CANCELED” is displayed.

◇ **Regular call**

The nature of the distress call should be included in the distress call.

- ① Push **[MENU]** to enter the DSC menu.
- ② Push **[▲]** or **[▼]** to select “DISTRESS,” and push **[ENT]**.



- ③ Push **[▲]** or **[▼]** to select the nature of the distress, push **[ENT]**.
 - ‘UNDESIGNATED,’ ‘EXPLOSION,’ ‘FLOODING,’ ‘COLLISION,’ ‘GROUNDING,’ ‘CAPSIZING,’ ‘SINKING,’ ‘ADRIFT (Disable adrift),’ ‘ABANDONING (Abandoning ship),’ ‘PIRACY (Piracy attack),’ and ‘MOB (Man overboard)’ are available.
 - The selected nature of the distress is stored for 10 minutes.



When a GPS receiver (NMEA0183 ver. 2.0 or 3.01) is connected, next steps ④, ⑤ (Current position/time programming) do not appear. Go to step ⑥.

➔ Continue to the next page

6 DSC OPERATION

- ④ The position information appears. Set your latitude data using [▲] or [▼]. After setting the latitude data, push [ENT] to set your longitude data.
- Push [CH•DUAL] or [16•C] to move the cursor forward or backward, respectively.
 - Push [▲] or [▼] to edit N; North latitude or S; South latitude when the cursor is on the 'N' or 'S' position, and W; West longitude or E; East longitude when the cursor is on the 'W' or 'E' position.
 - Push [CLR] to cancel and exit the condition.



- ⑤ After setting the longitude data, push [ENT] to set the current UTC time using [▲] or [▼], then push [ENT].
- Push [CH•DUAL] or [16•C] to move the cursor forward or backward, respectively.
 - Push [CLR] to cancel and exit the condition.



- ⑥ Push [DISTRESS] for 3 sec. to transmit the distress call.
- While pushing [DISTRESS], the key backlighting is blinking.
 - The distress information is stored for 10 minutes.
 - Emergency channel (Ch70) is automatically selected and the Distress call is transmitted.
 - Push [CLR] to exit the condition.



- ⑦ After transmitting the distress call, the transceiver waits for an acknowledgment call on Ch 16.
- The distress call is automatically transmitted every 3.5 to 4.5 min.



- ⑧ After receiving the acknowledgment, reply using the microphone.

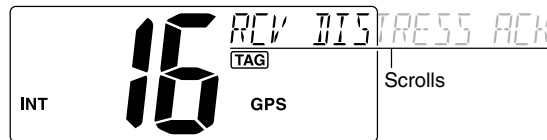

- ➔ A distress alert contains (default);
 - Nature of distress: Selected nature of the distress
 - Position data : GPS or manual input position data is held for 23.5 hrs or until the power is turned OFF.
- ➔ The Distress call is repeated every 3.5–4.5 min., until receiving an ‘acknowledgement.’ (‘Call repeat’ mode)
 - “RE-TRANSMISSION” is displayed.
- ➔ Push **[DISTRESS]** to transmit a renewed Distress call, if desired.
- ➔ Push **[CLR]** to transmit a the ‘Cancel ACK’ call to cancel the ‘Call repeat’ mode.
 - “CANCELED” is displayed.
- ➔ “??” may blink instead of position and time indications when the GPS data is invalid, or has not been manually updated after 4 hours.

■ Transmitting DSC calls

▨ To ensure correct operation of the DSC function, please make sure you set the squelch correctly. (p. 7)

◇ Transmitting an Individual call

The Individual call function allows you to transmit a DSC signal to a specific ship only.

- ① Push **[MENU]** to enter the DSC menu.
- ② Push **[▲]** or **[▼]** to select “INDIVIDUAL,” then push **[ENT]**.



- ③ Push **[▲]** or **[▼]** to select the desired pre-programmed Individual address or “MANUAL INPUT,” then push **[ENT]**.
 - The ID code for the individual can be set in advance. (p. 14)
 - When “MANUAL INPUT” is selected, set the 9-digit MMSI ID code for the individual you wish to call with **[▲]** or **[▼]**. (See **About Manual Inputting**; p. 22.)



➔ Continue to the next page

6 DSC OPERATION

About Manual Inputting:

Push [▲] or [▼] to input the 9-digit Individual ID, then push [ENT].

- Push [CH•DUAL] or [16•C] to move the cursor forward or backward, respectively.
- Push [CLR] to cancel and exit the condition.
- Go to the next step after pushing [ENT].



④ Push [▲] or [▼] to select the desired intership channel, then push [ENT].

- Intership channels are already preset into the transceiver in preferred order.
- After pushing [ENT], Channel 70 is automatically selected and "READY" appears at the channel comment indicator.

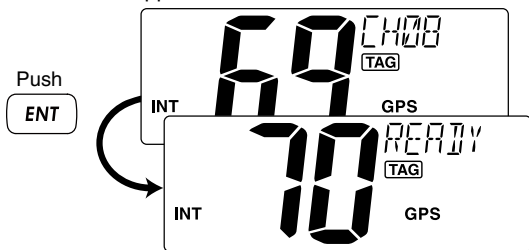

⑤ Push [ENT] to transmit the Individual call.

- If Channel 70 is busy, the transceiver stands by until the channel becomes clear.
- Routine category only is available.



⑥ Stands by on the operated channel (before entering the DSC menu in step ①), until an acknowledgement call is received.

- "WAITING FOR ACK" scrolls at the channel comment indicator.

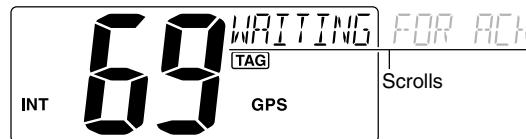

- ⑦ When the acknowledgement is received, “DSC” appears and “RCV ABLE ACK” or “RCV UNABLE ACK” scrolls at the channel comment indicator with beeps.
- Push [CLR] to stop the beep.



'Able to comply' is received.

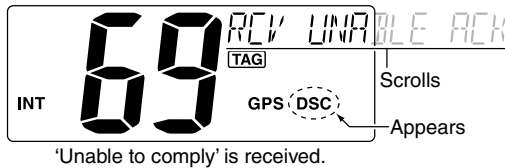

'Unable to comply' is received.

- ⑧ Push [ENT] to move to the intership channel, specified in step ④, then push and hold [PTT] to communicate your message to the responding ship when 'Able to comply' is received.
- Push [CLR] to return to the normal operation condition.
 - When 'Unable to comply' is received, push [ENT] to return to the normal operation condition.

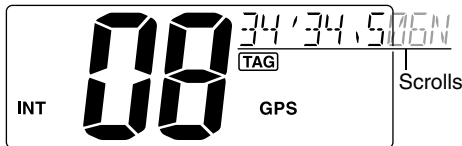

After receiving 'ABLE' ACK

◇ Transmitting an Individual acknowledgement

When receiving an Individual call, you can transmit an acknowledgement ('Able to comply' or 'Unable to comply') by using the on screen prompts (Quick ACK.) Also, you can send an acknowledgement through the menu system (Manual ACK.)

Quick ACK:

- After an Individual call is received, push [CLR] to stop beep, then push [ENT]. (Go to step ④ as below.)

Manual ACK:

- ① Push [MENU] to enter the DSC menu.
- ② Push [▲] or [▼] to select “INDV ACK,” the push [ENT].
 - “INDV ACK” item appears after receiving an Individual call.



- ③ Push [▲] or [▼] to select the desired individual address, then push [ENT].

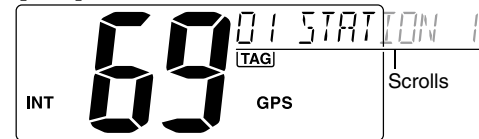

☞ Continue to the next page

6 DSC OPERATION

- ④ Push [▲] or [▼] to select the acknowledgement “ABLE” or “UNABLE,” then push [ENT].

- “UNABLE” selection will transmit the reason “No Reason Given”.
- After pushing [ENT], Channel 70 is automatically selected and “READY” appears at the channel comment indicator.

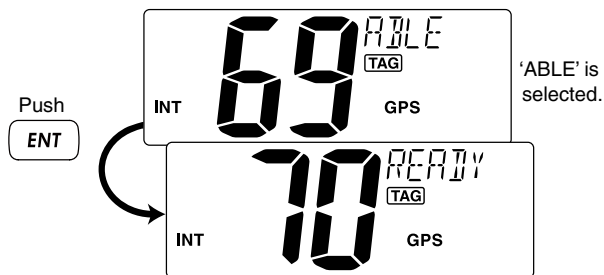

- ⑤ Push [ENT] to transmit the acknowledgement call to the selected station.

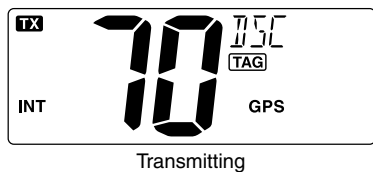

- ⑥ After the Individual acknowledgement call has been transmitted, the specified channel (specified by the calling station) is selected automatically when “ABLE” is selected, or returns to the previous condition (before entering the DSC menu) when “UNABLE” is selected in step ③.

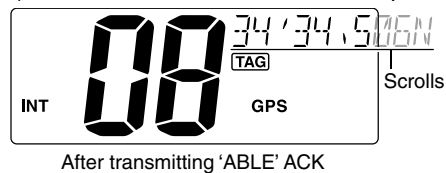

◇ Transmitting a Group call

The Group call function allows you to transmit a DSC signal to a specific group only.

- ① Push [MENU] to enter the DSC menu.
- ② Push [▲] or [▼] to select "GROUP," then push [ENT].



- ③ Push [▲] or [▼] to select the desired pre-programmed Group address or "MANUAL INPUT," then push [ENT].
 - The ID code for the group can be set in advance. (p. 15)
 - When "MANUAL INPUT" is selected, set the 8-digit MMSI ID code for the group you wish to call with [▲] or [▼]. (See **About Manual Inputting** as at right.)



About Manual Inputting:

Push [▲] or [▼] to input the 8-digit Group ID, then push [ENT].

- Push [CH•DUAL] or [16•C] to move the cursor forward or backward, respectively.
- Push [CLR] to cancel and exit the condition.
- 1st digit '0' is fixed for a Group ID.
- Go to the next step after pushing [ENT].



- ④ Push [▲] or [▼] to select the desired intership channel, then push [ENT].
 - Intership channels are already preset into the transceiver in recommending order.
 - After pushing [ENT], Channel 70 is automatically selected and "READY" appears at the channel comment indicator.

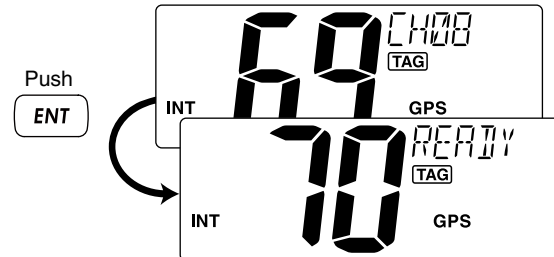

Continue to the next page

6 DSC OPERATION

- ⑤ Push **[ENT]** to transmit the Group call.
- If Channel 70 is busy, the transceiver stands by until the channel becomes clear.
 - Routine category only is available.



Transmitting

- ⑥ After the Group call has been transmitted, the specified channel (in step ④) is automatically selected.

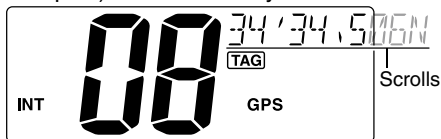

- ⑦ Push and hold **[PTT]** to announce your message to the responding ship.

◇ Transmitting an All Ships call

Large ships use Channel 70 as their 'listening channel.' When you want to announce a message to these ships within range, use the 'All Ships call' function.

- ① Push **[MENU]** to enter the DSC menu.
- ② Push **[▲]** or **[▼]** to select "ALL SHIPS," then push **[ENT]**.



- ③ Push **[▲]** or **[▼]** to select the desired category, then push **[ENT]**.
- Output power of 'Routine' category is 1 W (low power) only.
 - The selectable category may differ according to the programmed setting. Ask your dealer for the available categories.

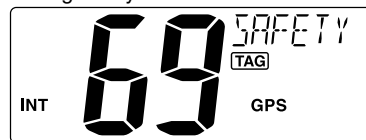

- ④ Push [▲] or [▼] to select the desired ITU channel, then push [ENT].
- After pushing [ENT], Channel 70 is automatically selected and “READY” appears at the channel comment indicator.

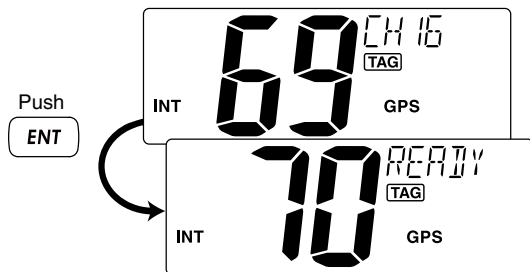

- ⑤ Push [ENT] to transmit the All Ships call.

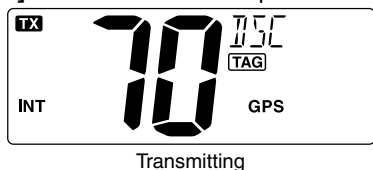

- ⑥ After the All Ships call has been transmitted, the specified channel (in step ④) is selected automatically.

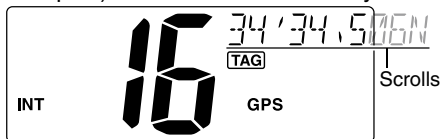

◇ Transmitting a Position Request call

Transmit a Position Request call when you want to know a specified ship's current position, etc.

- ① Push [MENU] to enter the DSC menu.
- ② Push [▲] or [▼] to select “POS REQUEST,” then push [ENT].



- ③ Push [▲] or [▼] to select the desired pre-programmed Individual address or “MANUAL INPUT,” then push [ENT].
 - The ID code for the individual can be set in advance. (p. 14)
 - When “MANUAL INPUT” is selected, set the 9-digit MMSI ID code for the individual you wish to call with [▲] or [▼]. (See *About Manual Inputting*; p. 22)



☞ Continue to the next page

6 DSC OPERATION

- ④ After step ③, Channel 70 is automatically selected and “READY” appears at the channel comment indicator.

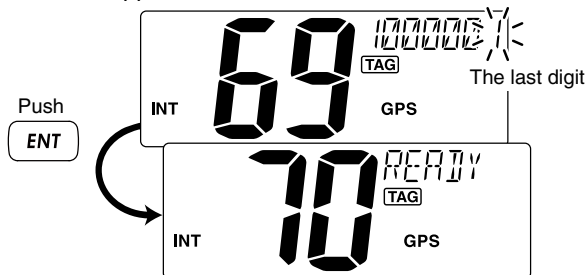

*This illustration describes with “MANUAL INPUT” selection in step ③.

- ⑤ Push [ENT] to transmit the Position Request call.
• If Channel 70 is busy, the transceiver stands by until the channel becomes clear.



Transmitting

- ⑥ After the Position Request call has been transmitted, returns to the normal operation.

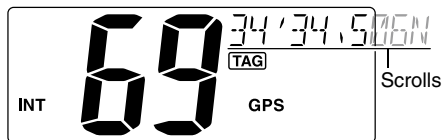

◇ Transmitting a Position Reply call

Transmit a Position Reply call when a Position Request call is received.

- ① Push [MENU] to enter the DSC menu.
- ② Push [▲] or [▼] to select “POS REPLY,” then push [ENT].
 - “POS REPLY” item appears after receiving a Position Request call.



- ③ Push [▲] or [▼] to select the desired individual address, then push [ENT].

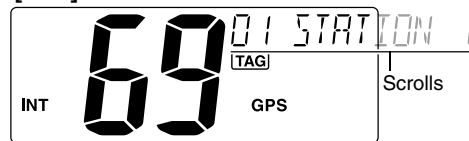

- ④ The position information appears. Input your position data (latitude and longitude) directly with [▲] or [▼]. (p. 17)

- ⑤ After editing the position data, push [ENT] to set. Then edit the current UTC time directly with [▲] or [▼] (p. 17), then push [ENT].
- After pushing [ENT], Channel 70 is automatically selected and “READY” appears at the channel comment indicator.



- ⑥ Push [ENT] to transmit the Position Reply call.



Transmitting

- ⑦ After the Position Reply call has been transmitted, returns to the normal operation.



◇ Transmitting a Polling Request call

Transmit a Polling Request call when you want to know a specific ship is in the communication area, etc.

- ① Push [MENU] to enter the DSC menu.
- ② Push [▲] or [▼] to select “POLL REQUEST,” then push [ENT].



- ③ Push [▲] or [▼] to select the desired pre-programmed Individual address or “MANUAL INPUT,” then push [ENT].
 - The ID code for the individual can be set in advance. (p. 14)
 - When “MANUAL INPUT” is selected, set the 9-digit MMSI ID code for the individual you wish to call with [▲] or [▼]. (See **About Manual Inputting**; p. 22)



☞ Continue to the next page

- ④ Push [ENT] to transmit the Polling Reply call.



Transmitting

- ⑤ After the Polling Reply call has been transmitted, returns to the normal operation.



◇ Test Call

Testing on the exclusive DSC distress and safety calling channels should be avoided as much as possible by using other methods. When testing on the distress/safety channel is unavoidable, it should be indicated that these are test transmissions.

Normally the test call would require no further communications between the two stations involved.

- ① Push [MENU] to enter the DSC menu.
- ② Push [▲] or [▼] to select “TEST CALL,” and then push [ENT].



- ③ Push [▲] or [▼] to select the desired pre-programmed Individual address or “MANUAL INPUT,” then push [ENT].
 - The ID code for the individual can be set in advance. (p. 14)
 - When “MANUAL INPUT” is selected, set the 9-digit MMSI ID code for the individual you wish to call with [▲] or [▼]. (See **About Manual Inputting**; p. 22)



Continue to the next page

6 DSC OPERATION

- ④ After step ③, Channel 70 is automatically selected and “READY” appears at the channel comment indicator.

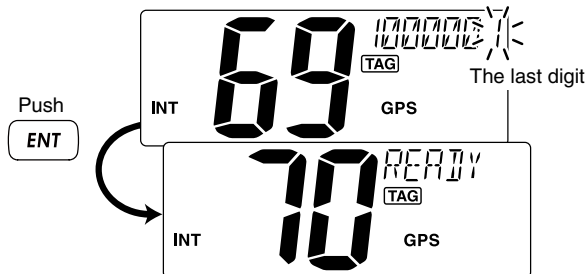

*This illustration describes with “MANUAL INPUT” selection in step ③.

- ④ Push [ENT] to transmit the Test call.
 • If Channel 70 is busy, the transceiver stands by until the channel becomes clear.

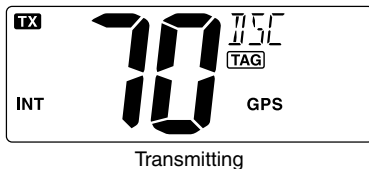

- ⑤ After the Test call has been transmitted, returns to the normal operation.



◇ Transmitting a Test Ack call

Transmit a Test Acknowledgement call when a Test call is received.

- ① Push [MENU] to enter the DSC menu.
- ② Push [▲] or [▼] to select “TEST ACK,” then push [ENT].
 - “TEST ACK” item appears after receiving a Polling Request call.



- ③ Push [▲] or [▼] to select the desired individual address, then push [ENT].
 - After pushing [ENT], Channel 70 is automatically selected and “READY” appears at the channel comment indicator.

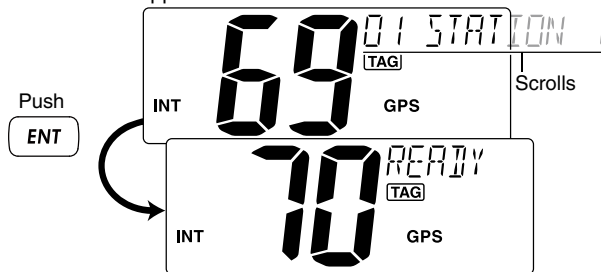

- ④ Push [ENT] to transmit the Test Ack call.



Transmitting

- ⑤ After the Test Ack call has been transmitted, returns to the normal operation.



■ Receiving DSC calls

◇ Receiving a Distress call

While monitoring Channel 70 and a Distress call is received:

- The emergency alarm sounds for 2 minutes.
 - Push any key to stop the alarm.
- “DSC” appears and “RCV DISTRESS” scrolls at the channel comment indicator, then Channel 16 is selected automatically.
- Continue monitoring Channel 16 as a coast station may require assistance.

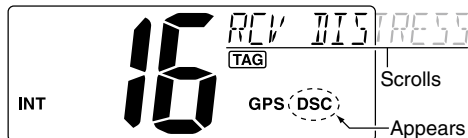

◇ Receiving a Distress Acknowledgement

While monitoring Channel 70 and a Distress acknowledgement to other ship is received:

- The emergency alarm sounds for 2 minutes.
 - Push any key to stop the alarm.
- “DSC” appears and “RCV DISTRESS ACK” scrolls at the channel comment indicator, then Channel 16 is selected automatically.

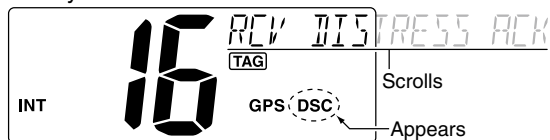

◇ Receiving a Distress Relay call

While monitoring Channel 70 and a Distress Relay is received:

- The emergency alarm sounds for 2 minutes.
 - Push any key to stop the alarm.
- “DSC” appears and “RCV RELAY” scrolls at the channel comment indicator, then Channel 16 is selected automatically.



◇ Receiving a Distress Relay Acknowledgement

While monitoring Channel 70 and a Distress Relay acknowledgement is received:

- The emergency alarm sounds for 2 minutes.
 - Push any key to stop the alarm.
- “DSC” appears and “RCV RELAY ACK” scrolls at the channel comment indicator, then Channel 16 is selected automatically.



▨ **NOTE:** The alarm sounds when duplicate distress relay or distress relay acknowledgement call for individual is received within 1 hour.

◇ Receiving an Individual call

While monitoring Channel 70 and an Individual call is received:

- The emergency alarm or beeps sound for 2 minutes depending on the received category.
 - Push **[CLR]** to stop the alarm or beeps.
- “**DSC**” appears and “**RCV INDIVIDUAL**” scrolls at the channel comment indicator.



- Push **[ENT]** to reply the call and select the channel specified by the calling station for voice communication (depending on your replying condition. See p. 23 for Individual acknowledgement call procedure for details.); push **[CLR]** other key to ignore the call.

◇ Receiving a Group call

While monitoring Channel 70 and a Group call is received:

- The emergency alarm or beeps sound for 2 minutes depending on the received category.
 - Push **[CLR]** to stop the alarm or beeps.
- “**DSC**” appears and “**RCV GROUP**” scrolls at the channel comment indicator.
- Push **[ENT]** to select the channel specified by the calling station for voice communication; push **[CLR]** to ignore the call.



6 DSC OPERATION

◇ Receiving an All Ships call

While monitoring Channel 70 and an All Ships call is received:

- The emergency alarm sounds for 2 minutes depending on the received categories.
 - Push **[CLR]** to stop the alarm or beeps.
- “**DSC**” appears and “**RCV ALL SHIPS**” scrolls at the channel comment indicator.
- Push **[ENT]** to monitor Channel 16 for an announcement from the calling vessel, push **[CLR]** to ignore the call.

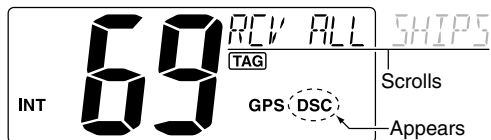

◇ Receiving a Geographical Area call

While monitoring Channel 70 and a Geographical Area call (for the area you are in) is received:

- The emergency alarm or beeps sound for 2 minutes depending on the received category.
 - Push **[CLR]** to stop the alarm or beeps.
- “**DSC**” appears and “**RCV GEOGRAPHICAL**” scrolls at the channel comment indicator.

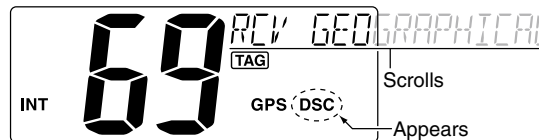

- Push **[ENT]** to select the channel specified by the calling station for voice communication; push **[CLR]** to ignore the call.
- Monitor the selected channel for an announcement from the calling station.

/// When no GPS receiver is connected or if there is a problem with the connected receiver, all Geographical Area calls are received, regardless of your position.

◇ Receiving a Position Request call

While monitoring Channel 70 and a Position Request call is received:

- “DSC” appears and “RCV POS REQUEST” scrolls at the channel comment indicator.
- The beeps sound for 2 minutes.
 - Push [CLR] to stop the beeps.
- Push [ENT] to reply to the call; push [CLR] to ignore the call.

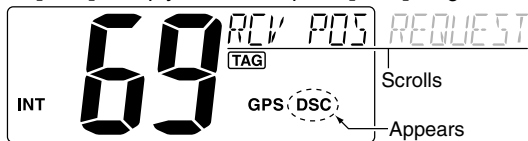

◇ Receiving a Polling Request call

While monitoring Channel 70 and a Polling Request call is received:

- “DSC” appears and “RCV POLL REQUEST” scrolls at the channel comment indicator.
- The beeps sound for 2 minutes.
 - Push [CLR] to stop the beeps.
- Push [ENT] to reply to the call; push [CLR] to ignore the call.

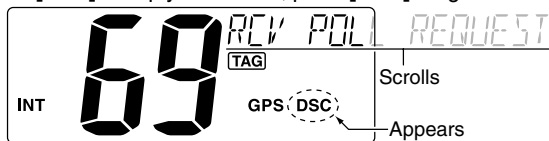

◇ Receiving a Position Reply call

While monitoring Channel 70 and a Position Request Reply call is received:

- “DSC” and “POS REPLY” appear in the display.
 - The ‘Latitude’ and ‘Longitude’ from the called station is displayed and scrolled at the channel comment indicator in order of Latitude co-ordinates and then Longitude co-ordinates.
 - “NO POSITION” scrolls at the channel comment indicator when no position information is received.
- The beeps sound for 2 minutes.
 - Push [CLR] to stop the beeps.

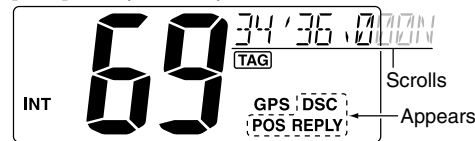

◇ Receiving a Polling Reply call

While monitoring Channel 70 and a Polling Reply call is received:

- “DSC” appears and “RCV POLL REPLY” scrolls at the channel comment indicator.
- The beeps sound for 2 minutes.
 - Push [CLR] to stop the beeps.



6 DSC OPERATION

◇ Receiving a Test call

While monitoring Channel 70 and a Test call is received:

- “DSC” appears and “RCV TEST CALL” scrolls at the channel comment indicator.
- The beeps sound for 2 minutes.
 - Push [CLR] to stop the beeps.
- Push [ENT] to reply to the call; push [CLR] to ignore the call.

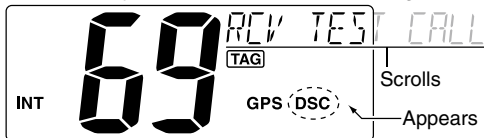

◇ Receiving a Test Acknowledgement call

While monitoring Channel 70 and a Test Acknowledgement call is received:

- “DSC” appears and “RCV TEST ACK” scrolls at the channel comment indicator.
- The beeps sound for 2 minutes.
 - Push [CLR] to stop the beeps.
- Push [ENT] to reply to the call; push [CLR] to ignore the call.

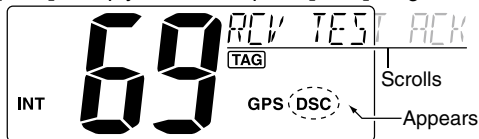

■ Received messages

The transceiver automatically stores up to 20 distress messages and 20 other messages. The messages can be used as an assistance to the logbook.

◇ Distress message

- ① Push [MENU] to enter the DSC menu.
- ② Push [▲] or [▼] to select “DSC LOG,” and push [ENT].



- ③ Push [▲] or [▼] to select “DISTRESS,” push [ENT].



- ④ Push [▲] or [▼] to select the desired message, push [ENT].
 - “*” appears when the unread messages is selected.



- ⑤ The message information scrolls.
 - The stored message has various information.
 - Push [CLR] to exit the condition.
 - Push and hold [CLR] for 1 sec. to delete the displayed message and returns to DSC menu.



◇ Other messages

- ① Push [MENU] to enter the DSC menu.
- ② Push [▲] or [▼] to select “DSC LOG,” and push [ENT].



- ③ Push [▲] or [▼] to select “OTHER,” push [ENT].



- ④ Push [▲] or [▼] to select the desired message, push [ENT].
 - “*” appears when the unread messages is selected.

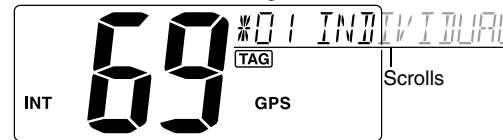

- ⑤ The message information scrolls.
 - The stored message has various information.
 - Push [CLR] to exit the condition.
 - Push and hold [CLR] for 1 sec. to delete the displayed message and returns to DSC menu.



■ Automatic acknowledgement

This item sets the automatic acknowledgement function ON or OFF.

When a position request or polling request call is received, transceiver automatically transmits a position request reply or polling reply call, respectively.

- ① Push **[MENU]** to enter the DSC menu.
- ② Push **[▲]** or **[▼]** to select "AUTO ACK," and push **[ENT]**.



- ③ Push **[▲]** or **[▼]** to turn the automatic acknowledgement function ON or OFF.



- ④ Push **[ENT]** to set the condition.
 - Push **[CLR]** to cancel and exit the condition.

■ Offset time

This item sets the offset time from the UTC (Universal Time Coordinated) time.

- ① Push **[MENU]** to enter the DSC menu.
- ② Push **[▲]** or **[▼]** to select "OFFSET TIME," and push **[ENT]**.



- ③ Set the offset time from the UTC (Universal Time Coordinated) time using **[▲]** or **[▼]**.
 - Push **[CH•DUAL]** or **[16•C]** to move the cursor forward or backward, respectively.
 - Push **[CLR]** to cancel and exit the condition.



- ④ Push **[ENT]** to program and to exit the condition.

/// The local time indication is not available when the GPS receiver (sentence formatter RMC) is connected, the transceiver's display indicates UTC time only.

■ Set mode programming

Set mode is used to change the conditions of the transceiver's functions: Scan type, Scan resume timer, Dual/Tri-watch, Operation beep, LCD backlight, LCD contrast, AF level adjustment and Favorite channel.

▨ Available functions may differ depending on dealer setting.

- ① Turn power OFF.
- ② While pushing [16•C], turn power ON to enter Set mode.
 - "SCAN" appears at the channel comment indicator.
- ③ After the display appears, release [16•C].
- ④ Push [16•C] to select the desired item, if necessary.
- ⑤ Push [▲] or [▼] to select the desired condition of the item.
- ⑥ Turn power OFF, then ON again to exit Set mode.

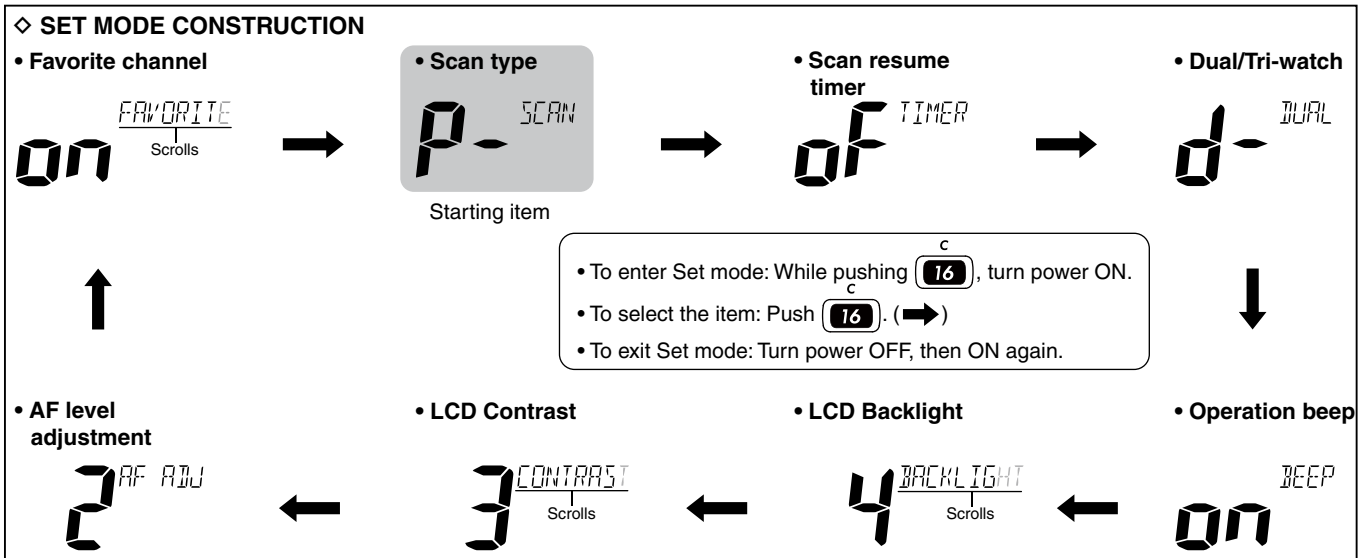

■ Set mode items

◇ Scan type

The transceiver has 2 scan types: Normal scan and Priority scan. Normal scan searches all TAG channels in the selected channel group. Priority scan searches all TAG channels in sequence while monitoring Channel 16.



Priority scan (default)



Normal scan

◇ Scan resume timer

The scan resume timer can be selected as a pause (OFF) or timer scan (ON).

ON : The scan pauses 5 sec. and resumes even if a signal has been received on any other channel than Channel 16.

OFF : The scan pauses until the signal disappears.



Scan timer OFF (default)



Scan timer ON

◇ Dual/Tri-watch

This item can be selected as Dualwatch or Tri-watch. (p. 12)

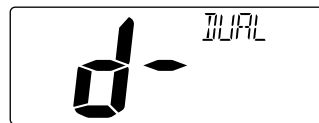

Dualwatch (default)

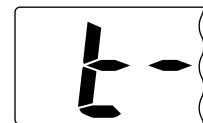

Tri-watch

◇ Operation beep

You can select the silent operation by turning beep tones OFF or you can have confirmation beeps sound at the push of a key by turning beep tones ON.



Beep tone ON (default)



Beep tone OFF

◇ **LCD backlight**

The LCD backlight brightness can be adjusted from OFF, 1 (dark) to 4 (bright.)

LCD backlight is also adjustable via [**SCAN•TAG**] key. (p. 9)

- “BACKLIGHT” scrolls at the channel comment indicator.



LCD backlight level 4 (default)



LCD backlight OFF

◇ **LCD contrast**

The LCD contrast can be adjustable in 4 levels. 1 is the lowest contrast, and 4 is the highest contrast.

- “CONTRAST” scrolls at the channel comment indicator.



LCD contrast level 3 (default)

◇ **AF level adjustment**

When turning the power ON, a beep is emitted to adjust the audio frequency level via [**VOL**].

Select the time period for the beep emission from 2, 5, 8, 10 (sec.) or OFF.



AF level 2 (default)



AF level OFF

◇ **Favorite channel**

This item sets the Favorite channel function ON or OFF.

The favorite channels are set by the TAG channel setting. (p. 11)

- “FAVORITE” scrolls at the channel comment indicator.

ON : [**▲**]/[**▼**] keys on the microphone select the favorite channels in the selected channel group in sequence when pushed.

OFF : [**▲**]/[**▼**] keys on the microphone select all channels in the selected channel group in sequence when pushed.



Favorite channel ON (default)



Favorite channel OFF

8

CONNECTIONS AND MAINTENANCE

■ Connections

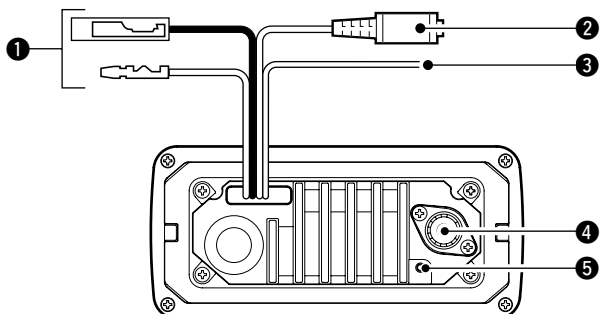

❶ DC POWER CONNECTOR

Connects the supplied DC power cable from this connector to an external 13.8 V battery.

❷ EXTERNAL SPEAKER JACK

Connects to an external speaker.

❸ GPS RECEIVER JACK

Connects to a GPS receiver for position indication.

- A NMEA0183 ver. 2.0 or 3.01 (sentence formatters RMC, GGA, GNS, GLL) compatible GPS receiver is required. Ask your dealer about suitable GPS receivers.

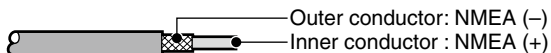

CAUTION: After connecting the DC power cable, GPS receiver jack and external speaker jack, cover the connector and jacks with an adhesive tape as shown below, to prevent water seeping into the transceiver.

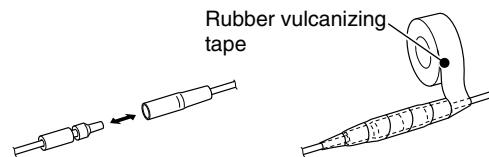

❹ ANTENNA CONNECTOR

Connects a marine VHF antenna with a PL-259 connector to the transceiver.

CAUTION: Transmitting without an antenna may damage the transceiver.

❺ GROUND TERMINAL

Connect this terminal to a vessel ground to prevent electrical shocks and interference from other equipment occurring. Use a PH M3 × 6 mm screw (not supplied).

■ Antenna

A key element in the performance of any communication system is the antenna. Ask your dealer about antennas and the best place to mount them.

■ Fuse replacement

One fuse is installed in the supplied DC power cable. If a fuse blows or the transceiver stops functioning, track down the source of the problem, if possible, and replace the damaged fuse with a new one of the proper rating.

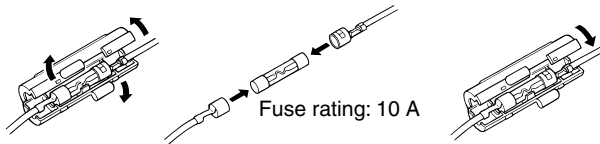

■ Cleaning

If the transceiver becomes dusty or dirty, wipe it clean with a soft, dry cloth.



AVOID the use of solvents such as benzene or alcohol, as they may damage transceiver surfaces.

■ Supplied accessories

The following accessories are supplied;

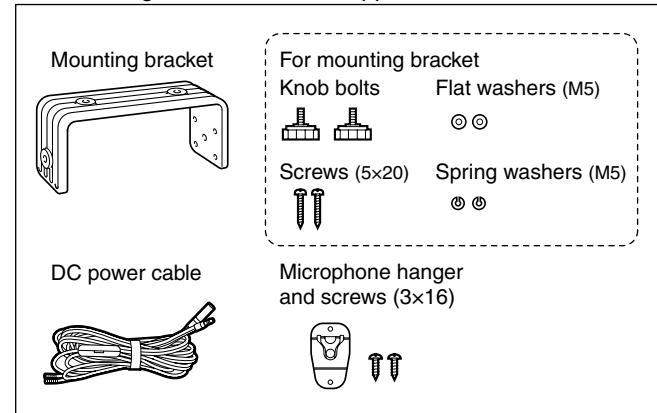

■ Mounting the transceiver

◇ Using the supplied mounting bracket

The universal mounting bracket supplied with your transceiver allows overhead or dashboard mounting.

- Mount the transceiver securely with the 2 supplied screws (5 × 20) to a surface which is more than 10 mm thick and can support more than 5 kg.
- Mount the transceiver so that the face of the transceiver is at 90° to your line of sight when operating it.

/// **CAUTION: KEEP** the transceiver and microphone at least 1 meter away from your vessel's magnetic navigation compass.

/// **NOTE:** Check the installation angle; the function display may not be easy-to-read at some angles.

EXAMPLE

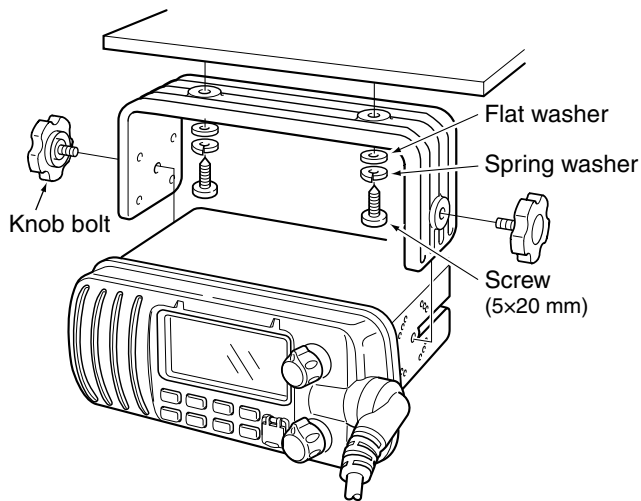

■ Optional MB-69 installation

An optional MB-69 FLUSH MOUNT is available for mounting the transceiver to a flat surface such as an instrument panel.

CAUTION: KEEP the transceiver and microphone at least 1 meter away from your vessel's magnetic navigation compass.

- ① Using the template on p. 55, carefully cut a hole into the instrument panel (or wherever you plan to mount the transceiver.)
- ② Slide the transceiver through the hole as shown below.

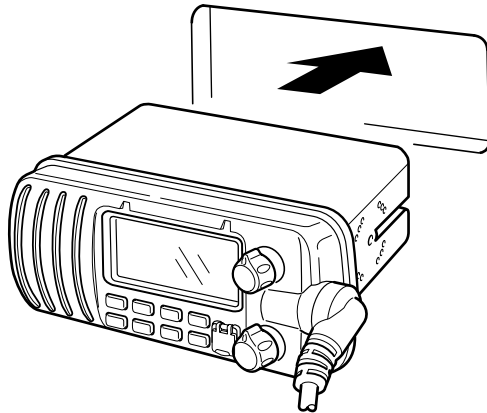

- ③ Attach the clamps on either side of the transceiver with 2 supplied bolts (5 × 8 mm).
 - Make sure that the clamps align parallel to the transceiver body.

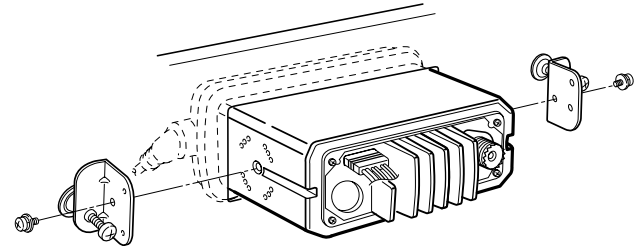

- ④ Tighten the end bolts on the clamps (rotate clockwise) so that the clamps press firmly against the inside of the instrument control panel.
- ⑤ Tighten the locking nuts (rotate counterclockwise) so that the transceiver is securely mounted in position as below.
- ⑥ Connect the antenna and power cable, then return the instrument control panel to its original place.

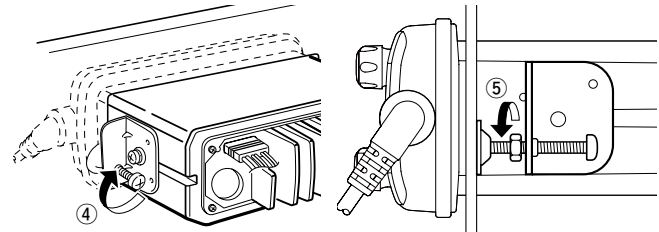

9

TROUBLESHOOTING

PROBLEM	POSSIBLE CAUSE	SOLUTION	REF.
The transceiver does not turn ON.	<ul style="list-style-type: none"> • Bad connection to the power supply. 	<ul style="list-style-type: none"> • Check the connection to the transceiver. 	p. 44
No sound from speaker.	<ul style="list-style-type: none"> • Squelch level is too high. • Volume level is too low. • Speaker has been exposed to water. 	<ul style="list-style-type: none"> • Set [SQL] to the threshold point. • Set [VOL] to a suitable level. • Drain water from the speaker. 	<p>p. 7</p> <p>p. 7</p> <p>p. 9</p>
Transmitting is impossible, or high power can not be selected.	<ul style="list-style-type: none"> • Some channels are for low power or receive only. • The output power is set to low. 	<ul style="list-style-type: none"> • Change channels. • Push [HI/LO] on the microphone to select high power. 	<p>pgs. 5,</p> <p>6, 52</p> <p>p. 7</p>
Scan does not start.	<ul style="list-style-type: none"> • TAG channel is not programmed. 	<ul style="list-style-type: none"> • Set the desired channels as TAG channels. 	p. 11
No beeps.	<ul style="list-style-type: none"> • Beep tones are turned OFF. 	<ul style="list-style-type: none"> • Turn the beep tone ON in Set mode. 	p. 42
Distress call cannot be transmitted.	<ul style="list-style-type: none"> • MMSI (DSC self ID) code is not programmed. 	<ul style="list-style-type: none"> • Program the MMSI (DSC self ID) code. 	p. 13

■ Specifications

◇ General

- Frequency coverage : Tx 156.000–161.450 MHz
Rx 156.000–163.425 MHz
- Mode : FM (16K0G3E),
DSC (16K0G2B)
- Channel spacing : 25 kHz
- Current drain (at 13.8 V) : TX high 5.5 A max.
Max. audio 1.5 A max.
- Power supply requirement: 13.8 V DC (10.8 to 15.6 V)
(negative ground)
- Frequency stability : Less than ± 1.5 kHz
- Operating temp. range : -20°C to $+60^{\circ}\text{C}$
- Antenna impedance : 50 Ω nominal
- Input impedance (MIC) : 2 k Ω
- Output impedance (audio): 4 Ω
- Dimensions : 164(W) \times 78(H) \times 139.5(D) mm
(Projections not included)
- Weight : Approx. 1080 g

◇ Transmitter

- RF output power : 25 W/1 W
- Modulation system : Variable reactance frequency
modulation
- Max. frequency deviation : ± 5.0 kHz
- Spurious emissions : Less than 0.25 μW
- Adjacent channel power : More than 70 dB
- Audio harmonic distortion : Less than 10%
(at 60% deviation)
- Residual modulation : More than 40 dB
- Audio frequency response: +1 to -3 dB of 6 dB/octave
range from 300 to 3000 Hz

◇ Receiver

- Receive system : Double conversion
superheterodyne
- Sensitivity (20 dB SINAD) : -5 dB μ emf (typical)
- Squelch sensitivity : Less than -2 dB μ emf
- Intermodulation rejection ratio : More than 68 dB
- Spurious response rejection ratio : More than 70 dB
- Adjacent channel selectivity : More than 70 dB
- Audio output power : More than 2.0 W
at 10% distortion
with a 4 Ω load

All stated specifications are subject to change without notice or obligation.

10 SPECIFICATIONS AND OPTION

◇ Dimensions

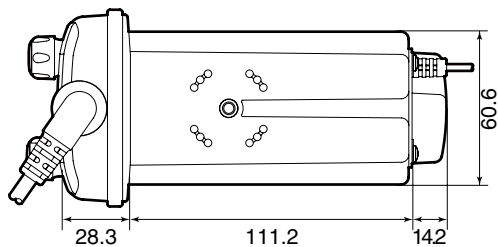
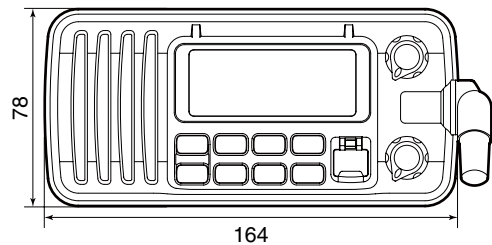
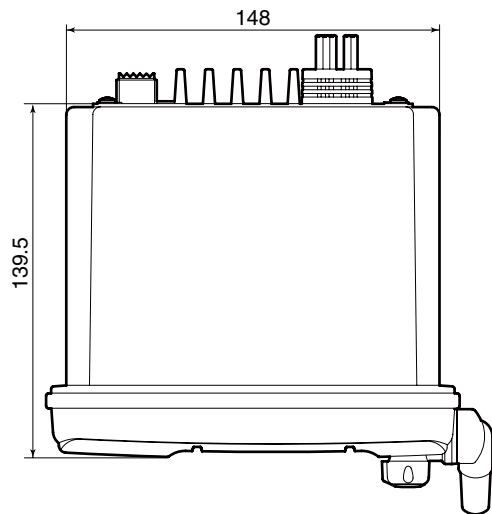

Unit: mm

■ Option

- **MB-69** FLUSH MOUNT KIT

For mounting the transceiver to a panel.

11 CHANNEL LIST

• International channels

CH	Frequency (MHz)		CH	Frequency (MHz)		CH	Frequency (MHz)		CH	Frequency (MHz)		CH	Frequency (MHz)		CH	Frequency (MHz)	
	Transmit	Receive		Transmit	Receive		Transmit	Receive		Transmit	Receive		Transmit	Receive		Transmit	Receive
01	156.050	160.650	11	156.550	156.550	21	157.050	161.650	61	156.075	160.675	71	156.575	156.575	81	157.075	161.675
02	156.100	160.700	12	156.600	156.600	22	157.100	161.700	62	156.125	160.725	72	156.625	156.625	82	157.125	161.725
03	156.150	160.750	13	156.650	156.650	23	157.150	161.750	63	156.175	160.775	73	156.675	156.675	83	157.175	161.775
04	156.200	160.800	14	156.700	156.700	24	157.200	161.800	64	156.225	160.825	74	156.725	156.725	84	157.225	161.825
05	156.250	160.850	15 ^{*2}	156.750	156.750	25	157.250	161.850	65	156.275	160.875	75 ^{*4}	156.775	156.775	85	157.275	161.875
06	156.300	156.300	16	156.800	156.800	26	157.300	161.900	66	156.325	160.925	76 ^{*4}	156.825	156.825	86	157.325	161.925
07	156.350	160.950	17 ^{*2}	156.850	156.850	27	157.350	161.950	67	156.375	156.375	77	156.875	156.875	87	157.375	157.375
08	156.400	156.400	18	156.900	161.500	28	157.400	162.000	68	156.425	156.425	78	156.925	161.525	88	157.425	157.425
09	156.450	156.450	19	156.950	161.550	37A ^{*3}	157.850	157.850	69	156.475	156.475	79	156.975	161.575	P4 ^{*3}	161.425	161.425
10	156.500	156.500	20	157.000	161.600	60	156.025	160.625	70 ^{*1}	156.525	156.525	80	157.025	161.625			

*1 DSC operation only.

*2 Channels 15 and 17 may also be used for on-board communications provided the effective radiated power does not exceed 1 W, and subject to the national regulations of the administration concerned when these channels are used in its territorial waters.

*3 UK Marina Channels: M1=37A (157.850 MHz), M2=P4 (161.425 MHz) for U.K. version only

*4 The use of these channels should be restricted to navigation-related communications only and all precautions should be taken to avoid harmful interference to channel 16, e.g. by limiting the output power to 1 W or by means geographical separation.

• **USA channels** (for U.K. version only)

CH	Frequency (MHz)		CH	Frequency (MHz)		CH	Frequency (MHz)		CH	Frequency (MHz)		CH	Frequency (MHz)		CH	Frequency (MHz)	
	Transmit	Receive		Transmit	Receive		Transmit	Receive		Transmit	Receive		Transmit	Receive		Transmit	Receive
01A	156.050	156.050	12	156.600	156.600	22A	157.100	157.100	64A	156.225	156.225	75* ¹	156.775	156.775	85	157.275	161.875
--	---	---	13* ²	156.650	156.650	23A	157.150	157.150	65A	156.275	156.275	76* ¹	156.825	156.825	85A	157.275	157.275
03A	156.150	156.150	14	156.700	156.700	24	157.200	161.800	66A	156.325	156.325	77* ¹	156.875	156.875	86	157.325	161.925
--	---	---	15* ²	156.750	156.750	25	157.250	161.850	67* ²	156.375	156.375	78A	156.925	156.925	86A	157.325	157.325
05A	156.250	156.250	16	156.800	156.800	26	157.300	161.900	68	156.425	156.425	79A	156.975	156.975	87	157.375	161.975
06	156.300	156.300	17* ¹	156.850	156.850	27	157.350	161.950	69	156.475	156.475	80A	157.025	157.025	87A	157.375	157.375
07A	156.350	156.350	18A	156.900	156.900	28	157.400	162.000	70* ³	156.525	156.525	81A	157.075	157.075	88	157.425	162.025
08	156.400	156.400	19A	156.950	156.950	37A* ⁴	157.850	157.850	71	156.575	156.575	82A	157.125	157.125	88A	157.425	157.425
09	156.450	156.450	20	157.000	161.600	61A	156.075	156.075	72	156.625	156.625	83A	157.175	157.175	P4* ⁴	161.425	161.425
10	156.500	156.500	20A	157.000	157.000	--	---	---	73	156.675	156.675	84	157.225	161.825			
11	156.550	156.550	21A	157.050	157.050	63A	156.175	156.175	74	156.725	156.725	84A	157.225	157.225			

*¹ Low power only.

*² Momentary high power.



*³ DSC operation only.

*⁴ UK Marina Channels: M1=37A (157.850 MHz), M2=P4 (161.425 MHz) for U.K. version only

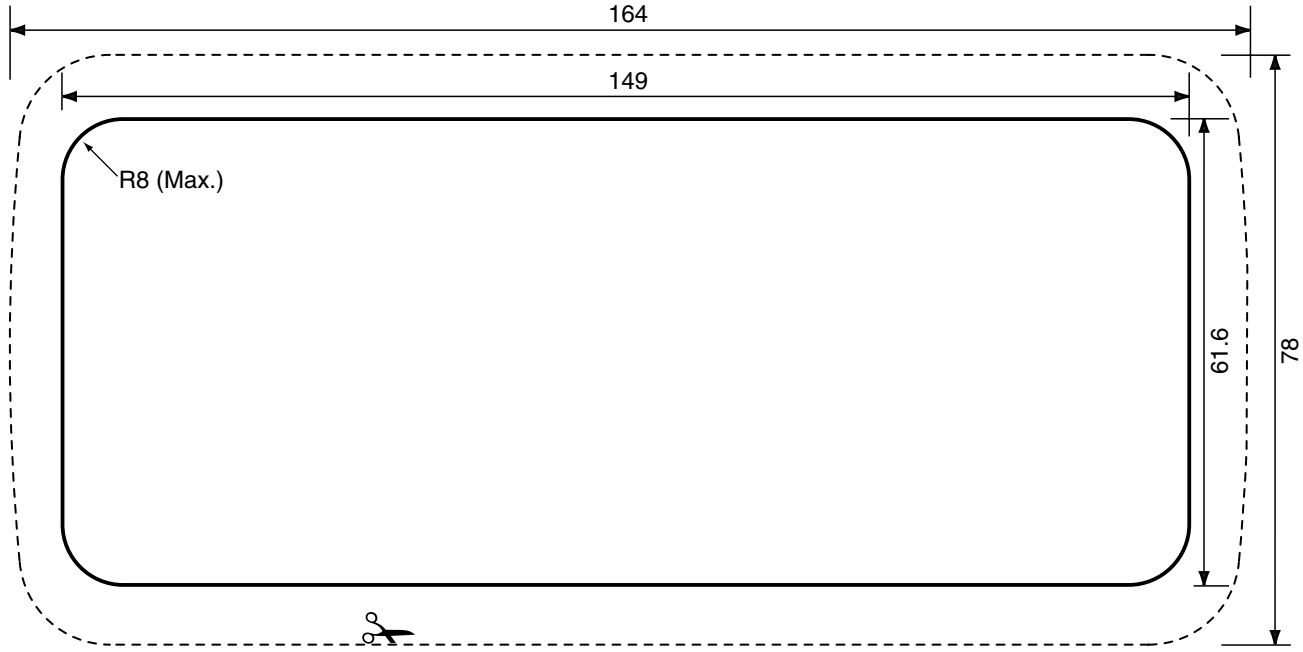
NOTE: Simplex channels, 3, 21, 23, 61, 64, 81, 82 and 83 **CANNOT** be lawfully used by the general public in U.S.A. waters.



Unit: mm

-  **NOTE:** The solid line is the line to use when cutting into the dash/helm.
-  The dotted line shows the outline of the IC-M411's front panel once the radio is fitted into the hole.
-  Do not follow the dotted line when making the hole in your dash/helm.

Cut here

Count on us!

< Intended Country of Use >

AT BE CY CZ DK EE
FI FR DE GR HU IE
IT LV LT LU MT NL
PL PT SK SI ES SE
GB IS LI NO CH BG
RO TR HR

A-6615D-1EU-①
Printed in Japan
© 2007 Icom Inc.

Printed on recycled paper with soy ink.

Icom Inc.

1-1-32 Kamiminami, Hirano-ku, Osaka 547-0003, Japan