



INSTRUCTION MANUAL

VHF MARINE TRANSCEIVER

IC-M401EURO

Icom Inc.

IN CASE OF EMERGENCY

If your vessel requires assistance, contact other vessels and the Coast Guard by sending a distress call on Channel 16.

USING CHANNEL 16

DISTRESS CALL PROCEDURE

1. "MAYDAY MAYDAY MAYDAY."
2. "THIS IS" (name of vessel)
3. Your call sign or other indication of the vessel (AND 9-digit DSC ID if you have one).
4. "LOCATED AT" (your position)
5. The nature of the distress and assistance required.
6. Any other information which might facilitate the rescue.

Or, transmit your distress call using digital selective calling on Channel 70 (the optional DS-100 (#02) must be installed).

USING DIGITAL SELECTIVE CALLING (ch 70)

(DS-100 DSC CONTROLLER is required)

DISTRESS CALL PROCEDURE

1. Push and hold [DISTRESS] on the DS-100 for 5 sec. until you hear 5 short beeps change to one long beep.
2. Wait for an acknowledgment from a coast station.
 - Channel 16 is automatically selected.
3. Push and hold [PTT], then transmit the appropriate information as at left.



Versions of the IC-M401EURO which display the "CE" symbol on the serial number seal, comply with the essential requirements of the European Radio and Telecommunication Terminal Directive 1999/5/EC. Ⓢ This warning symbol indicates that this equipment operates in non-harmonised frequency bands and/or may be subject to licensing conditions in the country of use. Be sure to check that you have the correct version of this radio or the correct programming of this radio, to comply with national licensing requirement.

Icom, Icom Inc. and the  logo are registered trademarks of Icom Incorporated (Japan) in the United States, the United Kingdom, Germany, France, Spain, Russia and/or other countries.

INSTALLATION NOTES

The installation of this equipment should be made in such a manner as to respect the EC recommended electromagnetic field exposure limits (1999/519/EC).

The maximum RF power available from this device is 25 watts. The antenna should be installed as high as possible for maximum efficiency and that this installation height should be at least 5 meters above ground (or

accessible) level. In the case where an antenna cannot be installed at a reasonable height, then the transmitter should neither be continuously operated for long periods if any person is within 5 meters of the antenna, nor operated at all if any person is touching the antenna.

In all cases any possible risk depends on the transmitter being activated for long periods.

(actual recommendation limits are specified as an average of 6 minutes) Normally the transmitter is not active for long periods of time. Some radio licenses will require that a timer circuit automatically cuts the transmitter after 1–2 minutes etc.

Similarly some types of transmitter, SSB, CW, AM, etc. have a lower 'average' output power and the perceived risk is even lower.

TABLE OF CONTENTS

1 OPERATING RULES	1	5 SCAN OPERATION	12–13	■ Connections	17
2 PANEL DESCRIPTION	2–4	■ Scan types	12	■ Mounting the transceiver	18
■ Panel description	2	■ Setting tag channels	13	■ Dimensions	20
■ Function display	3	■ Starting a scan	13	8 TROUBLESHOOTING	22
■ Microphone	4	6 SET MODE	14–15	9 CHANNEL LIST	23
3 BASIC OPERATION	6–9	■ Set mode programming	14	10 SPECIFICATIONS AND OPTIONS ...	24
■ Channel selection	6	■ Set mode items	15	■ Specifications	24
■ Receiving and transmitting	8	7 CONNECTIONS AND		■ Options	24
■ Call channel programming	9	MAINTENANCE	16–20		
■ Memory channel names	9	■ Unpacking	16	MB-69 TEMPLATE	
4 DUALWATCH/TRI-WATCH	10–11	■ Antenna	16		
■ Description	10	■ Fuse replacement	16		
■ Operation	10	■ Cleaning	16		

IMPORTANT

READ ALL INSTRUCTIONS carefully and completely before using the transceiver.

SAVE THIS INSTRUCTION MANUAL — This instruction manual contains important operating instructions for the IC-M401EURO.

CAUTION

⚠ WARNING! NEVER connect the transceiver to an AC outlet. This may pose a fire hazard or result in an electric shock.

NEVER connect the transceiver to a power source of more than 16 V DC or using reverse polarity. This will ruin the transceiver.

NEVER cut the DC power cable between the DC plug and fuse holder. If an incorrect connection is made after cutting, the transceiver may be damaged.

NEVER place the transceiver where normal operation of the vessel may be hindered or where it could cause bodily injury.

KEEP the transceiver at least 1 m away from the ship's navigation compass.

DO NOT use or place the transceiver in areas with temperatures below -20°C or above $+60^{\circ}\text{C}$ or, in areas subject to direct sunlight, such as the dashboard.

AVOID the use of chemical agents such as benzine or alcohol when cleaning, as they may damage the transceiver surfaces.

BE CAREFUL! The transceiver rear panel will become hot when operating continuously for long periods.

Place the transceiver in a secure place to avoid inadvertent use by children.

After exposure to salt water, clean the transceiver thoroughly with fresh water to avoid corrosion.

- Do not pour water on the transceiver under the water tap directly.

PRIORITIES

- Read all rules and regulations pertaining to priorities and keep an up-to-date copy handy. Safety and distress calls take priority over all others.
- You must monitor Channel 16 when you are not operating on another channel.
- False or fraudulent distress signals are prohibited and punishable by law.

PRIVACY

- Information overheard but not intended for you cannot lawfully be used in any way.
- Indecent or profane language is prohibited.

RADIO LICENSES

(1) SHIP STATION LICENSE

You must have a current radio station license before using the transceiver. It is unlawful to operate a ship station which is not licensed.

Inquire through your dealer or the appropriate government agency for a Ship-Radiotelephone license application. This government-issued license states the call sign which is your craft's identification for radio purposes.

(2) OPERATOR'S LICENSE

A Restricted Radiotelephone Operator Permit is the license most often held by small vessel radio operators when a radio is not required for safety purposes.

The Restricted Radiotelephone Operator Permit must be posted or kept with the operator. Only a licensed radio operator may operate a transceiver.

However, non-licensed individuals may talk over a transceiver if a licensed operator starts, supervises, ends the call and makes the necessary log entries.

Keep a copy of the current government rules and regulations handy.

■ Panel description

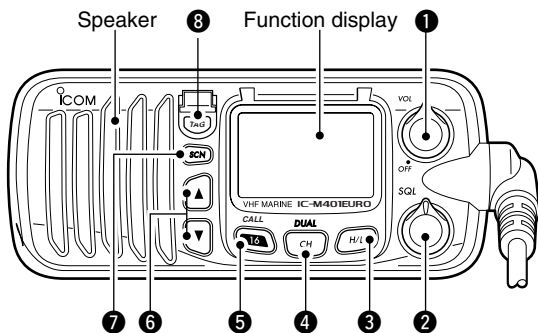

1 POWER/VOLUME CONTROL [VOL]

Turns power ON and OFF and adjusts the audio level. (p. 8)

2 SQUELCH CONTROL [SQL]

Sets the squelch threshold level. (p. 8)

3 TRANSMIT POWER SWITCH [H/L]

- ➔ Toggles high and low power when pushed. (p. 8)
 - Some channels are set to low power only.
- ➔ While pushing this switch, other switches perform secondary functions.

4 CHANNEL/DUALWATCH/TRI-WATCH SWITCH [CH]

- ➔ Exits from Channel 16 or call channel when pushed. (p. 6)
- ➔ While pushing [H/L], selects channel group when pushed. (p. 7)

- The European version has International channels only and this function is not available.

- ➔ Starts dualwatch or tri-watch when pushed for 1 sec.
- ➔ Stops dualwatch/tri-watch when either is activated.

5 CHANNEL 16/CALL CHANNEL SWITCH [16]

- ➔ Selects Channel 16 when pushed. (p. 6)
- ➔ Selects call channel when pushed for 1 sec. (p. 6)
 - “CALL” appears when call channel is selected.
- ➔ Push for 3 sec. to enter call channel programming condition when call channel is selected. (p. 9)
- ➔ While pushing [H/L], enters memory channel name programming condition. (p. 9)
- ➔ Enters set mode when pushed while turning power ON. (p. 14)

6 CHANNEL UP/DOWN SWITCHES [▲]/[▼]

- ➔ Push to select the operating channels, set mode contents, etc.
- ➔ While pushing [H/L], push [▲]/[▼] to adjust the brightness of the LCD and switch backlight.

7 SCAN SWITCH [SCN] (p. 13)

- ➔ Starts and stops normal or priority scan when tag channels are programmed.

8 TAG CHANNEL SWITCH (p. 13)

- ➔ Push [TAG] to set the displayed channel as a tag (scanned) channel.
- ➔ While pushing [H/L], push for 3 sec. to clear all tag channels.

■ Function display

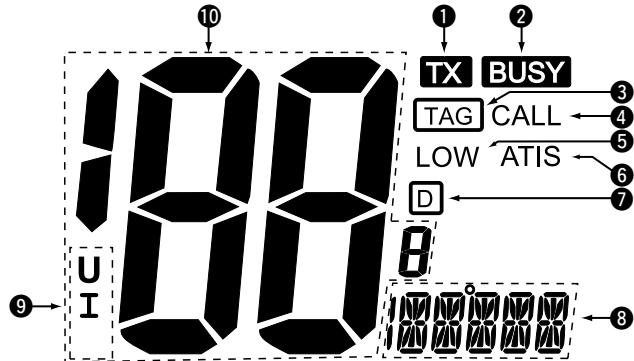

1 TRANSMIT INDICATOR (p. 8)

“TX” appears while transmitting.

2 BUSY INDICATOR (p. 8)

“BUSY” appears when receiving a signal or when the squelch opens.

3 TAG CHANNEL INDICATOR (p. 13)

Appears when a tag channel is selected.

4 CALL CHANNEL INDICATOR

“CALL” appears when the call channel is selected. (p. 6)

5 LOW POWER INDICATOR (p. 8)

“LOW” appears when low power is selected.

6 ATIS INDICATOR

- ➔ “ATIS” appears when the ATIS encoder is activated.
 - The ATIS encoder is available for Germany and Holland versions only.

7 DUPLEX INDICATOR (p. 7)

Appears when a duplex channel is selected.

8 CHANNEL NAME INDICATOR

- ➔ Memory channel name appears if programmed. (p. 9)
- ➔ “LOW BATTERY” scrolls when the battery voltage drops to approx. 10 V DC or below.
- ➔ “BW” appears during dualwatch; “TW” appears during triwatch. (p. 10)

9 CHANNEL GROUP INDICATOR (p. 7)

Indicates whether an International (I) or U.S.A (U) channel is selected.

- USA channel group is available for U.K. and Italy versions only.

10 CHANNEL NUMBER READOUT

- ➔ Indicates the selected operating channel number.
 - “A” appears when a simplex channel is selected. (p. 7)
- ➔ In set mode, indicates the selected condition. (p. 15)

2 PANEL DESCRIPTION

■ Microphone

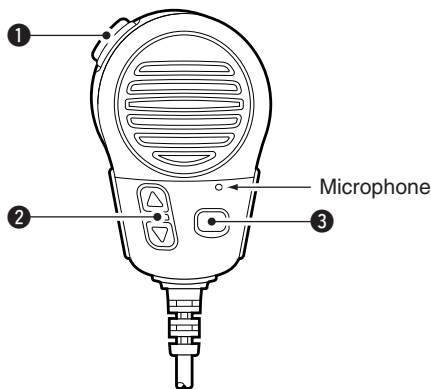

① PTT SWITCH [PTT]

Push and hold to transmit; release to receive. (p. 8)

② CHANNEL UP/DOWN SWITCHES [▲]/[▼]

Push either switch to change the operating memory channel, set mode contents, etc.

③ CHANNEL 16/CALL CHANNEL SWITCH [16/C]

- Same as the [16] switch on the front panel. (p. 2)
- Selects Channel 16 when pushed. (p. 6)
- Selects call channel when pushed for 1 sec. (p. 6)
 - “CALL” appears when call channel is selected.
- Push for 3 sec. to enter call channel programming condition when call channel is selected. (p. 9)
- While pushing [H/L], enters memory name programming condition. (p. 9)

• Microphone lock function

The microphone lock function electrically locks the [▲]/[▼] and [16/C] switches on the microphone. This prevents accidental channel changes and accidental function access.

- While pushing [16] on the microphone, turn power ON to toggle the microphone lock function ON and OFF.

Blank page

■ Channel selection

Channel 16

Channel 16 is the distress and safety channel. It is used for establishing initial contact with another station and for emergency communications. Channel 16 is monitored during both dualwatch and tri-watch. While standing by, you must monitor Channel 16.

- ➔ Push [16] momentarily to select Channel 16.
 - Output power turns to “25W” automatically, whenever Channel 16 is selected. For example, when selecting Channel 16 via the dial, dualwatch/tri-watch or a scan stops at Channel 16, etc.
- ➔ Push [CH] to return to the condition before selecting Channel 16, or push [▲]/[▼] to select an operating channel.

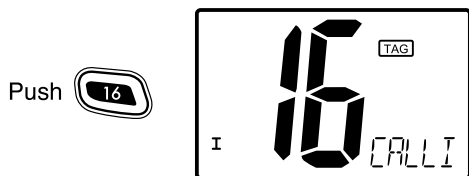

Call channel

Each regular channel group has a separate leisure-use call channel. The call channel is monitored during tri-watch. The call channels can be programmed (p. 9) and are used to store your most often used channels in each channel group for quick recall.

- ➔ Push [16] for 1 sec. to select the call channel of the selected channel group.
 - “CALL” and call channel number appear.
 - Each channel group may have an independent call channel after changing a call channel. (U.K. version only)
- ➔ Push [CH] to return to the condition before selecting call channel, or push [▲]/[▼] to select an operating channel.

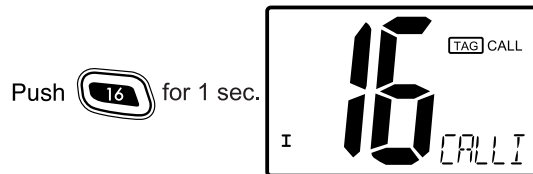

International channels

There are 57 International channels for the IC-M401EURO.

- ① Push [CH] to select a regular channel.
- ② While pushing [H/L], push [CH] to change the channel group, if necessary.
 - “I” appears when International channels are selected.
- ③ Push [▲]/[▼] to select the desired channel.
 - “D” appears for duplex channels.

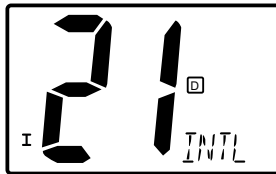

U.S.A. channels (U.K. version only)

For the U.K. and Italy versions, there are 58 U.S.A. channels in addition to 57 International channels.

- ① Push [CH] to select a regular channel.
- ② While pushing [H/L], push [CH] to change the channel group.
 - International and U.S.A. channels can be selected in sequence.
- ③ Push [▲]/[▼] to select the desired channel.
 - Channels are memorized separately for each channel group.

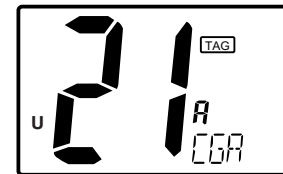

3 BASIC OPERATION

■ Receiving and transmitting

 **CAUTION:** Transmitting without an antenna may damage the transceiver.

- ① Turn [VOL] clockwise to turn power ON.
- ② Set the audio and squelch levels.
 - Rotate [SQL] fully counterclockwise in advance.
 - Rotate [VOL] to adjust the audio output level.
 - Rotate [SQL] clockwise until the noise disappears.
- ③ While pushing [H/L], push [CH] to change the channel group. (p. 7)
 - The European version has International channels only.
- ④ Push [▲]/[▼] to select the desired channel.
 - When receiving a signal, “BUSY” appears and audio is emitted from the speaker.
 - Further adjustment of [VOL] may be necessary at this point.
- ⑤ Push [H/L] to select the output power if necessary.
 - “LOW” appears when low power is selected, respectively.
 - Choose low power to conserve power, choose high power for longer distance communications.
 - Some channels are for low power only.
- ⑥ Push and hold [PTT] to transmit, then speak into the microphone.
 - “TX” appears.
 - Channel 70 cannot be used for transmission (for GMDSS use).
- ⑦ Release [PTT] to receive.

 **IMPORTANT:** To maximize the readability of your transmitted signal, pause a few sec. after pushing [PTT], hold the microphone 2 to 5 cm from your mouth and speak at a normal voice level.

■ Call channel programming

The call channel is used to select Channel 9, however, you can program your most often-used channels in each channel group for quick recall.

- ① While pushing [H/L], push [CH] one or more times to select the desired channel group (International or U.S.A.) to be programmed. (U.S.A. channel group is available for UK and Italy versions only.)
- ② Push [16] for 1 sec. to select the call channel of the selected channel group.
 - “CALL” and call channel number appear.
- ③ Push [16] again for 3 sec. (until long beep changes to 2 short beeps) to enter call channel programming condition.
 - Channel number starts flashing.
- ④ Push [▲]/[▼] to select the desired channel.
- ⑤ Push [16] to program the displayed channel as the call channel.
 - Push [CH] to cancel.
 - The channel number stops flashing.

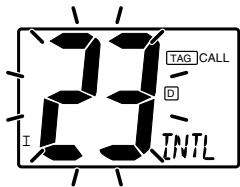
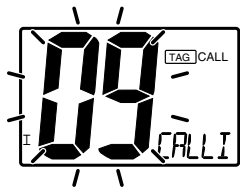

■ Memory channel names

Memory channels can be tagged with alphanumeric names of up to 10 characters each.

Capital letters, small letters, numerals, some symbols (! " # \$ % & ' () * + , - . /) and spaces can be used.

- ① Select the desired memory channel.
 - Cancel dual watch, tri-watch or scan in advance.
- ② While pushing [H/L], push [16] to edit memory channel name.
 - A cursor appears and blinks.



- ③ Select the desired character by pushing [▲]/[▼].
 - Push [CH] or [H/L] for cursor movement.
- ④ Push [16] to input and set the name.
 - Push [H/L] to cancel.
 - The cursor disappears.
- ⑤ Repeat steps ① to ④ to program other memory channel names, if desired.

■ Description

Dualwatch monitors Channel 16 while you are receiving another channel; tri-watch monitors Channel 16 and the call channel while receiving another channel.

DUALWATCH/TRI-WATCH SIMULATION

- If a signal is received on Channel 16, dualwatch/tri-watch pauses on Channel 16 until the signal disappears.
- If a signal is received on the call channel during tri-watch, tri-watch becomes dualwatch until the signal disappears.
- To transmit on the selected channel during dualwatch/tri-watch, push and hold [PTT].

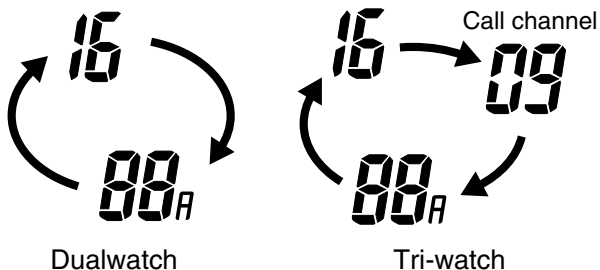

■ Operation

- ① Select the desired operating channel.
- ② Select dualwatch or tri-watch in set mode. (p. 15)
- ③ Push [CH] for 1 sec. to start dualwatch or tri-watch.
 - "DW" appears during dualwatch; "TW" appears during tri-watch.
 - Beep tone sounds when a signal is received on Channel 16.
- ④ To cancel dualwatch/tri-watch, push [CH] again.

[Example]

Operating dualwatch on INT Channel 25

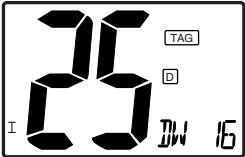

Dualwatch starts.



Signal received on Channel 16 takes priority.

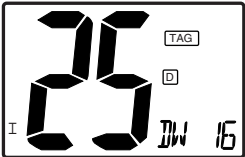

Dualwatch resumes after the signal disappears.

Operating tri-watch on INT Channel 25



Tri-watch starts.

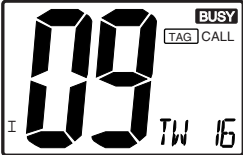

Signal is received on call channel.
• Tri-watch becomes dualwatch and monitors Channel 16 while receiving signal.

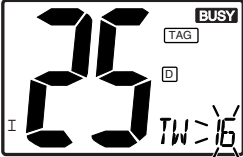

Signal received on Channel 16 takes priority.



Tri-watch resumes after the signal disappears.

■ Scan types

Scanning is an efficient way to locate signals quickly over a wide frequency range. The transceiver has priority scan and normal scan.

Set the tag channels (scanned channel) before scanning. Clear the tag channels which inconveniently stop scanning, such as channels used for digital communication.

/// Choose priority or normal scan in set mode. (p. 15)

PRIORITY SCAN

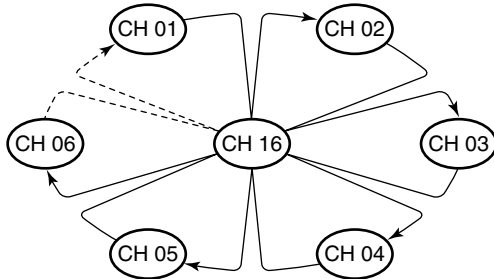

Priority scan searches through all tag channels in sequence while monitoring Channel 16. When a signal is detected on Channel 16, scan pauses until the signal disappears; when a signal is detected on a channel other than Channel 16, scan becomes dualwatch until the signal disappears.

NORMAL SCAN

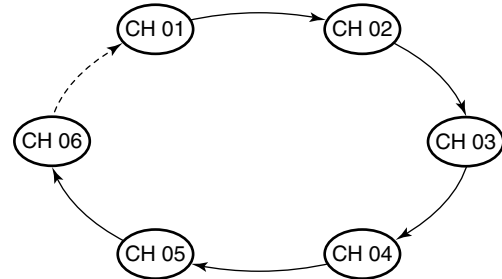

Normal scan, like priority scan, searches through all tag channels in sequence. However, unlike priority scan, Channel 16 is not checked unless Channel 16 is set as a tag channel.

■ Setting tag channels

For more efficient scanning, add desired channels as tag channels or clear tag channels for unwanted channels. Channels set as non-tag channels will be skipped during scanning. Tag channels can be assigned to each channel group independently.

- ① While pushing [H/L], push [CH] one or more times, select the desired channel group, if desired. (U.S.A. channel group is available for UK and Italy versions only.)
- ② Select the desired channel to set as a tag channel.
- ③ Push [TAG] to set the displayed channel as a tag channel.
 - “TAG” appears in the function display.
- ④ To cancel the tag channel setting, repeat ③.
 - “TAG” disappears.

• Clearing all tag channels in the selected channel group

- While pushing [H/L], push [TAG] for 3 sec. to clear all tag channels in the channel group.

■ Starting a scan

Set scan type (priority or normal scan) and scan resume timer in advance using set mode. (p. 15)

- ① Set tag channels as described at left.
- ② While pushing [H/L], push [CH] one or more times, select the desired channel group, if desired. (U.S.A. channel group is available for UK and Italy versions only.)
- ③ Push [SCN] to start priority or normal scan.
 - “SC 16” or “SCAN” appears in the function display.
 - When a signal is detected, scan pauses until the signal disappears or resumes after pausing 5 sec., according to set mode setting. (Channel 16 is still monitored during priority scan.)
 - Push [▲]/[▼] to check the scanning tag channels, to change the scanning direction or resume the scan manually.
 - “16” flashes and a beep tone sounds when a signal is received on Channel 16 during priority scan.
- ④ To stop the scan, push [SCN].
 - “SC 16” or “SCAN” disappears.

[Example]: Starting a priority scan.

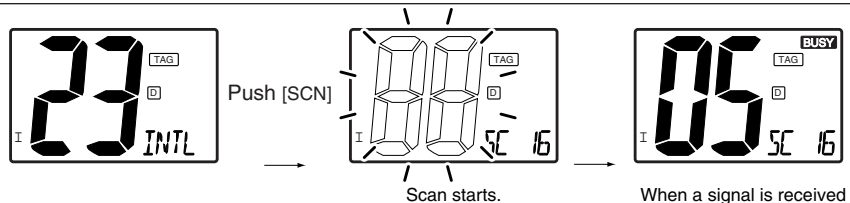

■ Set mode programming

Set mode is used to change the conditions of some of the transceiver's functions.

/// **NOTE:** Available functions may differ depending on dealer setting.

Entering set mode

- ① Turn power OFF.
- ② While pushing [16], turn power ON to enter set mode.
- ③ After the display appears, release [16].
- ④ Push [16] to select the desired item, if necessary.
- ⑤ Push [▲]/[▼] to select the desired condition of the item.
- ⑥ Turn power OFF, then ON again to exit set mode.

•SET MODE CONSTRUCTION

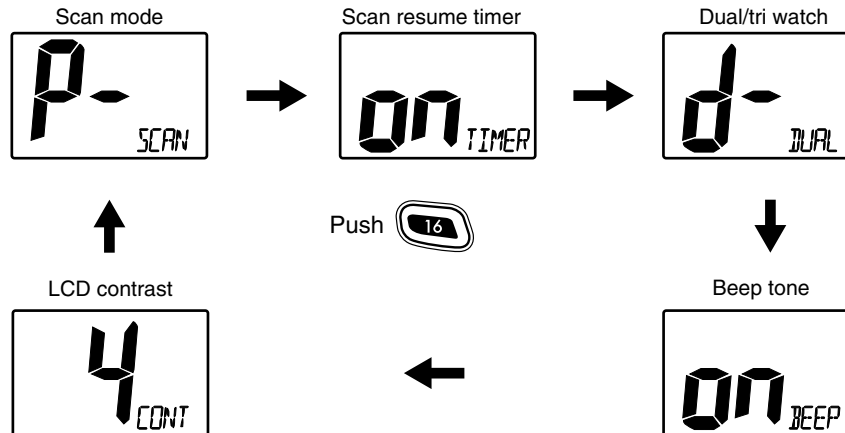

■ Set mode items

Scan mode

The scan mode can be selected as a normal scan or priority scan. (p. 12)

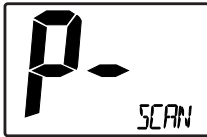

Priority scan (default)



Normal scan

Scan resume timer

The scan resume timer can be selected as a pause (OFF) or timer scan (ON). When OFF is selected, the scan pauses until the signal disappears. When ON is selected, the scan pauses 5 sec. and resumes even if a signal is being received on channels except for Channel 16.



Scan timer OFF (default)



Scan timer ON

Dualwatch/tri-watch

This item can be selected as dualwatch or tri-watch. (p. 10)

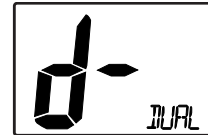

Dual watch (default)

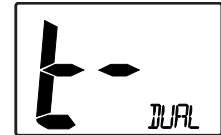

Tri-watch

Beep tone

You can select silent operation by turning beep tones OFF, or you can have confirmation beeps sound at the push of a switch by turning beep tones ON.



Beep tone ON (default)



Beep tone OFF

LCD contrast

This item adjusts the contrast of the LCD in 4 steps.



LCD contrast 3 (default)

■ Unpacking

The following accessories are supplied: Qty.

- ① Mounting bracket 1
- ② DC power cable (OPC-891) 1
- ③ Microphone hanger 1
- ④ Microphone hanger cable*
(OPC-1096 : Black or OPC-1097 : White) 1
- ⑤ Mounting bracket knobs 2
- ⑥ Microphone hanger screws (3 × 16 mm) 2
- ⑦ Mounting screws (5 × 20 mm) 2
- ⑧ Flat washers (M5) 2
- ⑨ Spring washers (M5) 2

*Depending on version.

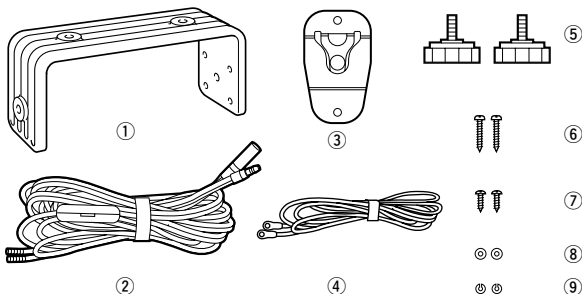

■ Antenna

A key element in the performance of any communication system is an antenna. Ask your dealer about antennas and the best places to mount them.

■ Fuse replacement

Two fuses are installed in the supplied DC power cable. If a fuse blows or the transceiver stops functioning, track down the source of the problem if possible, and replace the damaged fuse with a new, rated one.

■ Cleaning

If the transceiver becomes dusty or dirty, wipe it clean with a soft, dry cloth.



AVOID the use of solvents such as benzene or alcohol, as they may damage transceiver surfaces.

Connections

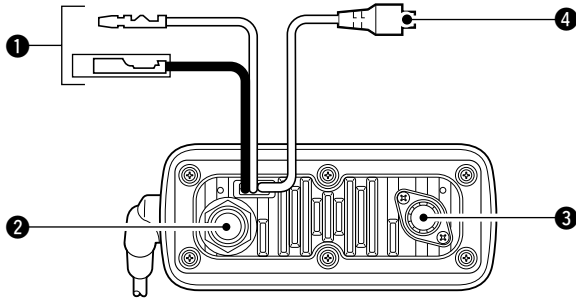

1 DC POWER CONNECTOR

Connects the supplied DC power cable from this connector to an external 12 V battery.

CAUTION: After connecting the DC power cable and external speaker jack, cover the connector and jack as shown below to avoid water seeping into the transceiver.

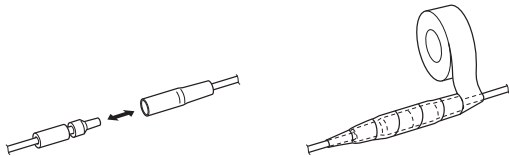

2 EXTENSION JACK

Connects to optional DS-100 (#02) DSC CONTROLLER.

3 ANTENNA CONNECTOR

Connects a marine VHF antenna with a PL-259 connector to the transceiver.

CAUTION: Transmitting without an antenna may damage the transceiver.

4 EXTERNAL SPEAKER JACK

Connects to an external speaker.

- See 'Options' on p. 24 for available external speakers.

MICROPHONE HANGER

Rest the supplied microphone on the hanger when not in use. Connect the OPC-1096/1097* to the antenna connector and microphone to use the microphone hanger function.

*Depending on version.

- Tighten the antenna connector screw at fixing torque 0.7 N•m (6.9 kg•m).
- If the microphone hanger function is used, Channel 16 is selected automatically when the supplied microphone is rested on the hanger.

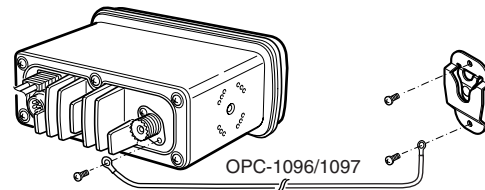

7 CONNECTIONS AND MAINTENANCE

■ Mounting the transceiver

Using the supplied mounting bracket

The universal mounting bracket supplied with your transceiver allows overhead or dashboard mounting.

- Mount the transceiver securely with the 2 supplied screws (5 × 20 mm) to a surface which is more than 10 mm thick and can support more than 5 kg.
- Mount the transceiver so that the face of the transceiver is at 90° to your line of sight when operating it.

/// **CAUTION: KEEP** the transceiver and microphone at least 1 meter away from your vessel's magnetic navigation compass.

/// **NOTE:** Check the installation angle; the function display may not be easy-to-read at some angles.

EXAMPLE

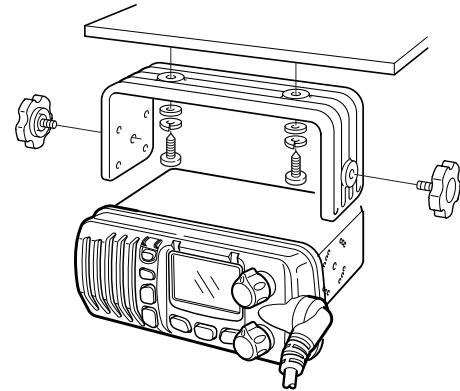

Using the optional mounting bracket

An optional MB-69 FLUSH MOUNT is available for mounting the transceiver to a flat surface such as an instrument panel.

CAUTION: KEEP the transceiver and microphone at least 1 meter away from your vessel's magnetic navigation compass.

- ① Using the template on the last page, carefully cut a hole into the instrument panel (or wherever you plan to mount the transceiver).
- ② Slide the transceiver through the hole as shown below.

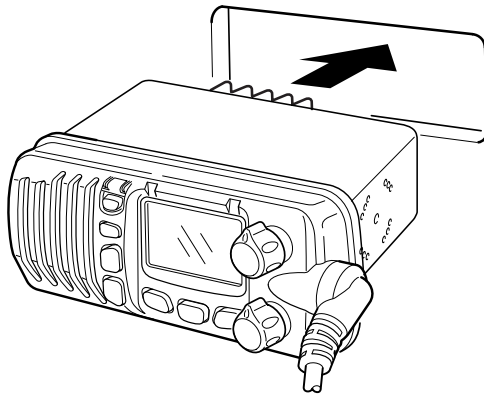

- ③ Attach the clamps on either side of the transceiver with 2 supplied bolts (5 × 8 mm).
 - Make sure that the clamps align parallel to the transceiver body.

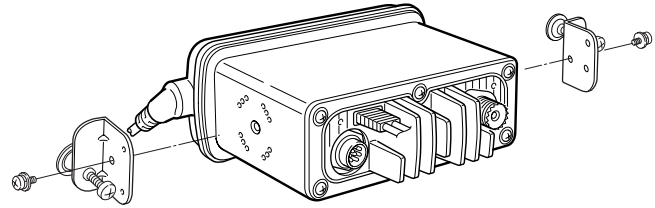

- ④ Tighten the end bolts on the clamps (rotate clockwise) so that the clamps press firmly against the inside of the instrument control panel.
- ⑤ Tighten the locking nuts (rotate counterclockwise) so that the transceiver is securely mounted in position as below.
- ⑥ Connect the antenna and control cable, then return the instrument control panel to its original place.

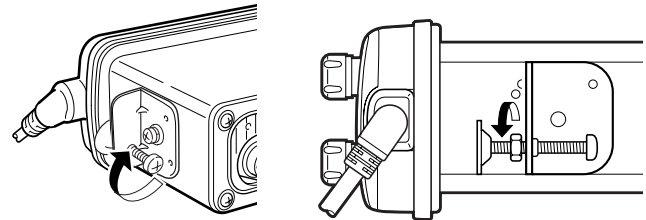

7 CONNECTIONS AND MAINTENANCE

■ Dimensions

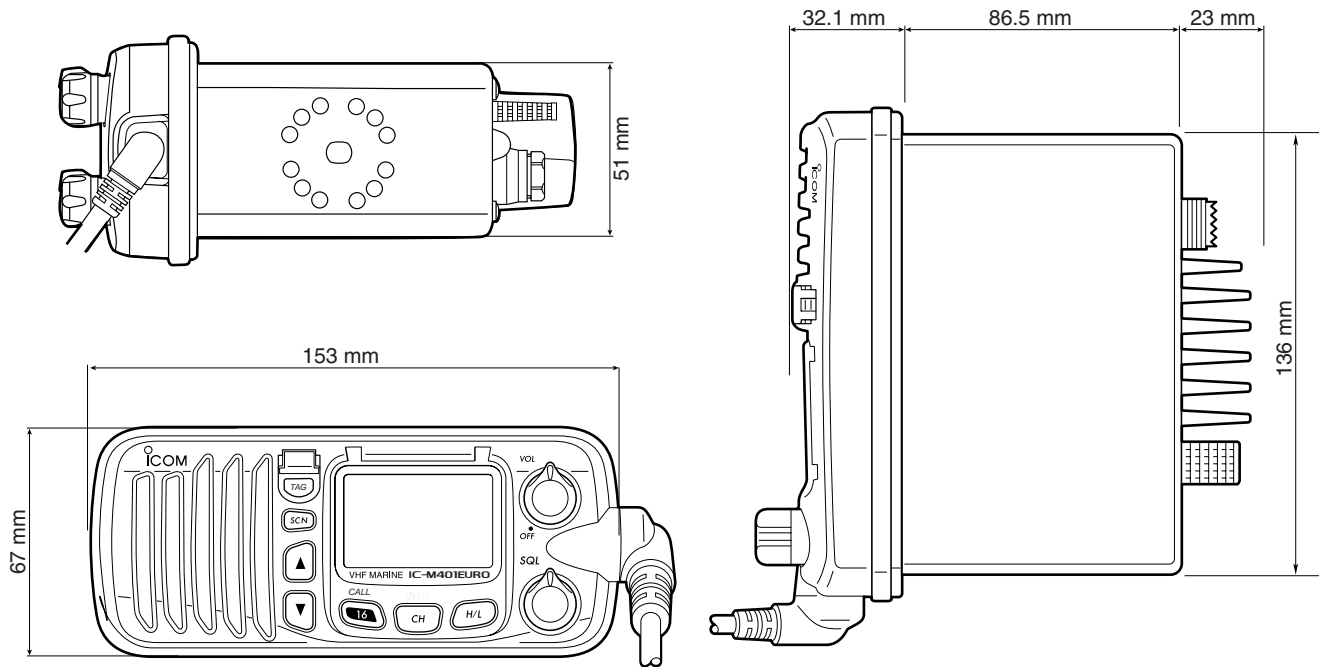

Blank page

8

TROUBLESHOOTING

PROBLEM	POSSIBLE CAUSE	SOLUTION	REF.
No power comes ON.	<ul style="list-style-type: none"> • Bad connection to the power supply. 	<ul style="list-style-type: none"> • Check the connection to the transceiver. 	p. 17
No sound comes from the speaker.	<ul style="list-style-type: none"> • Squelch level is too deep. • Volume level is too low. • Speaker has been exposed to water. 	<ul style="list-style-type: none"> • Set squelch to the threshold point. • Set [VOL] to a suitable level. • Drain water from the speaker. 	p. 8 p. 8 –
Transmitting is impossible, or high power cannot be selected.	<ul style="list-style-type: none"> • Some channels are for low power or receive only. • The output power is set to low. 	<ul style="list-style-type: none"> • Change channels. • Push [H/L] to select high power. 	pgs. 8, 23 p. 8
Scan does not start.	<ul style="list-style-type: none"> • “TAG” channel is not programmed. 	<ul style="list-style-type: none"> • Set the desired channels as “TAG” channels. 	p. 13
No beep sounds.	<ul style="list-style-type: none"> • Beep tone is turned OFF. 	<ul style="list-style-type: none"> • Turn the beep tone ON in set mode. 	p. 15

CHANNEL LIST

9

• International channels

CH	Frequency (MHz)		CH	Frequency (MHz)		CH	Frequency (MHz)		CH	Frequency (MHz)		CH	Frequency (MHz)		CH	Frequency (MHz)	
	Transmit	Receive		Transmit	Receive		Transmit	Receive		Transmit	Receive		Transmit	Receive		Transmit	Receive
01	156.050	160.650	11	156.550	156.550	21	157.050	161.650	62	156.125	160.725	72	156.625	156.625	82	157.125	161.725
02	156.100	160.700	12	156.600	156.600	22	157.100	161.700	63	156.175	160.775	73	156.675	156.675	83	157.175	161.775
03	156.150	160.750	13	156.650	156.650	23	157.150	161.750	64	156.225	160.825	74	156.725	156.725	84	157.225	161.825
04	156.200	160.800	14	156.700	156.700	24	157.200	161.800	65	156.275	160.875	75†	156.775	156.775	85	157.275	161.875
05	156.250	160.850	15†	156.750	156.750	25	157.250	161.850	66	156.325	160.925	76†	156.825	156.825	86	157.325	161.925
06	156.300	156.300	16	156.800	156.800	26	157.300	161.900	67	156.375	156.375	77	156.875	156.875	87	157.375	157.375
07	156.350	160.950	17†	156.850	156.850	27	157.350	161.950	68	156.425	156.425	78	156.925	161.525	88	157.425	157.425
08	156.400	156.400	18	156.900	161.500	28	157.400	162.000	69	156.475	156.475	79	156.975	161.575			
09	156.450	156.450	19	156.950	161.550	60	156.025	160.625	70‡	156.525	156.525	80	157.025	161.625			
10	156.500	156.500	20	157.000	161.600	61	156.075	160.675	71	156.575	156.575	81	157.075	161.675			

• USA channels (for U.K. version only)

CH	Frequency (MHz)		CH	Frequency (MHz)		CH	Frequency (MHz)		CH	Frequency (MHz)		CH	Frequency (MHz)		CH	Frequency (MHz)	
	Transmit	Receive		Transmit	Receive		Transmit	Receive		Transmit	Receive		Transmit	Receive		Transmit	Receive
01A	156.050	156.050	12	156.600	156.600	22A	157.100	157.100	64A	156.225	156.225	77	156.875	156.875	86	157.325	161.925
--	---	---	13†	156.650	156.650	23A	157.150	157.150	65A	156.275	156.275	78A	156.925	156.925	86A	157.325	157.325
03A	156.150	156.150	14	156.700	156.700	24	157.200	161.800	66A	156.325	156.325	79A	156.975	156.975	87	157.375	161.975
--	---	---	15†	156.750	156.750	25	157.250	161.850	67†	156.375	156.375	80A	157.025	157.025	87A	157.375	157.375
05A	156.250	156.250	16	156.800	156.800	26	157.300	161.900	68	156.425	156.425	81A	157.075	157.075	88	157.425	162.025
06	156.300	156.300	17†	156.850	156.850	27	157.350	161.950	69	156.475	156.475	82A	157.125	157.125	88A	157.425	157.425
07A	156.350	156.350	18A	156.900	156.900	28	157.400	162.000	70‡	156.525	156.525	83A	157.175	157.175			
08	156.400	156.400	19A	156.950	156.950	37A	157.850	157.850	71	156.575	156.575	84	157.225	161.825			
09	156.450	156.450	20	157.000	161.600	61A	156.075	156.075	72	156.625	156.625	84A	157.225	157.225			
10	156.500	156.500	20A	157.000	157.000	--	---	---	73	156.675	156.675	85	157.275	161.875			
11	156.550	156.550	21A	157.050	157.050	63A	156.175	156.175	74	156.725	156.725	85A	157.275	157.275			

†Low power only.

‡Receive only.

10 SPECIFICATIONS AND OPTIONS

■ Specifications

• GENERAL

- Frequency coverage :
 - Transmit : 156.025–157.425 MHz
(156.00–161.450MHz)*
 - Receive : 156.025–162.025 MHz
(156.00–163.425MHz)*

* Frequency range that may be subject to licensing conditions.

- Mode : FM (16K0G3E)/DSC (16K0G2B)
- Channel spacing : 25 kHz
- Current drain (at 13.8 V) : TX high 6.0 A max.
Max. audio 1.2 A max.
- Power supply requirement : 13.8 V DC
- Frequency stability : ± 1.5 kHz (-20°C to $+60^{\circ}\text{C}$)
- Dimensions : 153(W) \times 67(H) \times 141.6(D) mm
(Projection not included)
- Weight : 900 g

• TRANSMITTER

- Output power : 25 W and 1 W
- Modulation system : Variable reactance phase modulation
- Max. frequency deviation : ± 5.0 kHz
- Spurious emissions : Less than 0.25 μW

• RECEIVER

- Receive system : Double conversion superheterodyne
- Sensitivity (20 dB SINAD) : Less than -2 dB μ EMF (typical)
- Squelch sensitivity : Less than 0 dB μ EMF
- Intermodulation rejection ratio : More than 68 dB
- Spurious response rejection ratio : More than 70 dB
- Adjacent channel selectivity : More than 70 dB
- Audio output power : 2 W at 10% distortion with a 4 Ω load

■ Options

• DS-100 (#02) DSC CONTROLLER

When the DS-100 (#02) is installed, the transceiver conforms to DSC class D for marine digital communications.

• MB-69 FLUSH MOUNT

For mounting the transceiver to a panel.

• SP-5 EXTERNAL SPEAKER

A large, external speaker for superior audio output.

• SP-10 EXTERNAL SPEAKER

A compact, external speaker for easy installation.

All stated specifications are subject to change without notice or obligation.

MB-69 TEMPLATE

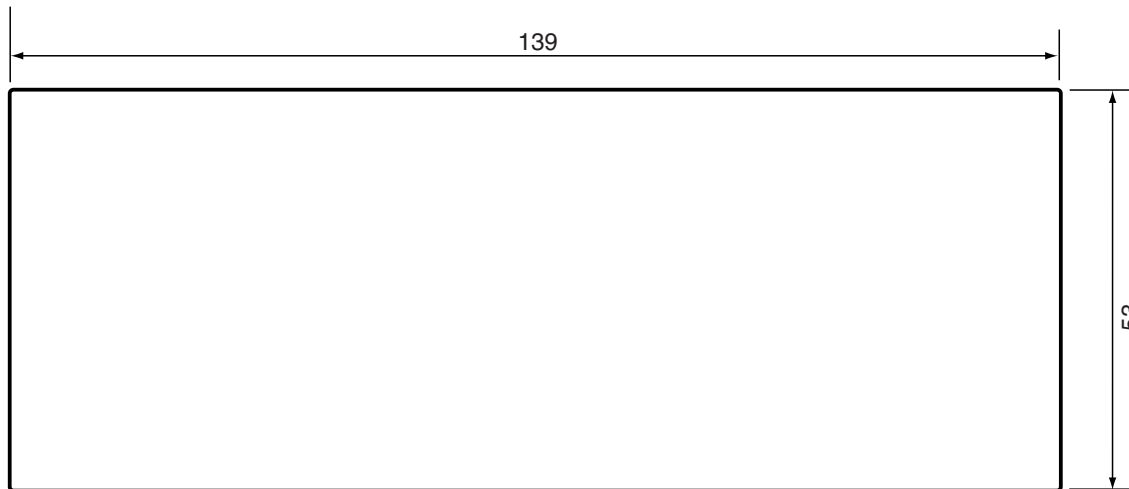

Unit: mm

Cut here

Blank page



DECLARATION OF CONFORMITY

We Icom Inc. Japan
1-1-32, Kamiminami, Hirano-ku
Osaka 547-0003, Japan

Declare on our sole responsibility that this equipment complies with the essential requirements of the Radio and Telecommunications Terminal Equipment Directive, 1999/5/EC, and that any applicable Essential Test Suite measurements have been performed.

Kind of equipment: VHF MARINE TRANSCEIVER

Type-designation: IC-M401EURO

Version (where applicable):

This compliances is based on conformity with the following harmonised standards, specifications or documents:

- | | | |
|-------|--------------|------------------|
| i) | EN 301 025-1 | V1.1.2 (2000-08) |
| ii) | EN 301 025-2 | V1.1.1 (2000-08) |
| iii) | EN 301 025-3 | V1.1.1 (2001-05) |
| iv) | EN 300 162-2 | V1.1.2 (2000-12) |
| v) | EN 300 162-3 | V1.1.1 (2001-05) |
| vi) | EN 60945 | 1997 |
| vii) | EN 60950 | 1992 |
| viii) | EN 300 698-2 | V1.1.1 (2000-8) |
| ix) | | |

C **€0560** **!**

Düsseldorf 31th May 2001

Place and date of issue

Icom (Europe) GmbH
Himmelgeister straÙe 100
D-40225 Düsseldorf

Authorized representative name

T. Maebayashi
General Manager

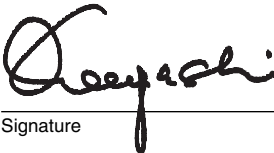
Signature

Icom Inc.

Count on us!

< Intended Country of Use >

- | | | |
|------------------------------|------------------------------|------------------------------|
| <input type="checkbox"/> GER | <input type="checkbox"/> NED | <input type="checkbox"/> ITA |
| <input type="checkbox"/> AUT | <input type="checkbox"/> BEL | <input type="checkbox"/> GRE |
| <input type="checkbox"/> GBR | <input type="checkbox"/> LUX | <input type="checkbox"/> SWE |
| <input type="checkbox"/> IRL | <input type="checkbox"/> ESP | <input type="checkbox"/> DEN |
| <input type="checkbox"/> FRA | <input type="checkbox"/> POR | <input type="checkbox"/> FIN |
| <input type="checkbox"/> SUI | | |