



INSTRUCTION MANUAL

VHF MARINE TRANSCEIVER IC-M31

Icom Inc.



IN CASE OF EMERGENCY

If your vessel requires assistance, contact other vessels and the Coast Guard by sending a distress call on Channel 16.

○ **USING CHANNEL 16**

DISTRESS CALL PROCEDURE

1. "MAYDAY MAYDAY MAYDAY."
2. "THIS IS" (name of vessel)
3. Your call sign or other indication of the vessel.
4. "LOCATED AT" (your position)
5. The nature of the distress and assistance required.
6. Any other information which might facilitate the rescue.

RECOMMENDATION

CLEAN THE TRANSCEIVER THOROUGHLY WITH FRESH WATER after exposure to saltwater, and dry it before operation. Otherwise, the transceiver's keys, switches and controllers may become inoperable due to salt crystallization.

NOTE: DO NOT wash the transceiver in water if there is any reason to suspect the waterproofing may not be effective. For example, in cases where the battery pack rubber seal is damaged, the transceiver/battery pack is cracked or broken, or has been dropped, or when the battery pack is detached from the transceiver.

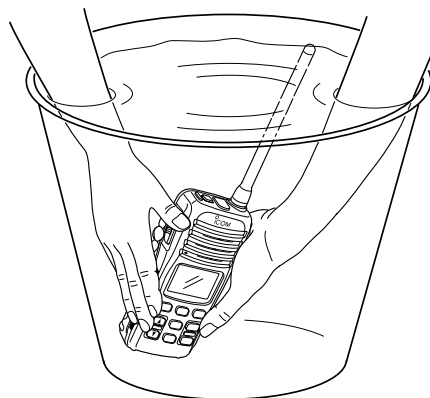

FOREWORD

Thank you for purchasing this Icom product. The IC-M31 VHF MARINE TRANSCEIVER is designed and built with Icom's state of the art technology and craftsmanship. With proper care this product should provide you with years of trouble-free operation.

IMPORTANT

READ ALL INSTRUCTIONS carefully and completely before using the transceiver.

SAVE THIS INSTRUCTION MANUAL—This instruction manual contains important operating instructions for the IC-M31.

EXPLICIT DEFINITIONS

WORD	DEFINITION
 WARNING	Personal injury, fire hazard or electric shock may occur.
CAUTION	Equipment damage may occur.
NOTE	If disregarded, inconvenience only. No risk of personal injury, fire or electric shock.

FEATURES

Waterproof construction

Built tough to withstand the punishing marine environment, the transceiver's submersible construction meets IPX7* requirements for waterproof protection (1 meter depth for 30 min.).

* Only when the battery pack, top plate and flexible antenna are attached.

Dualwatch and tri-watch functions

Convenient functions which allow you to monitor the distress channel (Ch 16) while receiving a channel of your choice—dual watch; or monitor the distress channel and another channel while receiving a channel of your choice—tri-watch.

Large, easy-to-read LCD

With dimensions of 16(H) × 32(W) mm, the function display is easy to read and shows operating conditions at a glance. Backlighting and contrast can be adjusted to suit your preferences.

Simple operation

9 large buttons on the front panel provide user-friendly operation. The independent volume and channel buttons are located on the front panel for convenient one-hand operation.

PRECAUTION

⚠ WARNING! NEVER connect the transceiver to an AC outlet. This may pose a fire hazard or result in an electric shock.

⚠ WARNING! NEVER hold the transceiver so that the antenna is very close to, or touching exposed parts of the body, especially the face or eyes, while transmitting. The transceiver will perform best if the microphone is 5 to 10 cm away from the lips and the transceiver is vertical.

⚠ WARNING! NEVER connect the transceiver to a power source other than the BP-223, BP-224, or BP-252. Such a connection will ruin the transceiver.

DO NOT use or place the transceiver in direct sunlight or in areas with temperatures below -15°C or above $+55^{\circ}\text{C}$.

KEEP the transceiver out of the reach of children.

KEEP the transceiver at least 0.9 meters away from your vessel's magnetic navigation compass.

BE CAREFUL! The transceiver's right-side panel will become hot when operating continuously for long periods.

BE CAREFUL! The transceiver meets IPX7* requirements for waterproof protection. However, once the transceiver has been dropped, waterproof protection cannot be guaranteed because of possible damage to the transceiver's case or the waterproof seal.

* Only when the battery pack, top plate and flexible antenna are attached.

MAKE SURE the flexible antenna, top plate and battery pack are securely attached to the transceiver, and that the antenna, top plate and battery pack are dry before attachment. Exposing the inside of the transceiver to water will result in serious damage to the transceiver.

After exposure to water, clean the battery contacts thoroughly with fresh water and dry them completely to remove any water or salt residue.

Icom, Icom Inc. and the Icom logo are registered trademarks of Icom Incorporated (Japan) in the United States, the United Kingdom, Germany, France, Spain, Russia and/or other countries.

TABLE OF CONTENTS

IN CASE OF EMERGENCY	i	5 SCAN OPERATION	13–14
RECOMMENDATION	i	■ Scan types	13
FOREWORD	ii	■ Setting tag channels	14
IMPORTANT	ii	■ Starting a scan	14
EXPLICIT DEFINITIONS	ii	6 DUALWATCH/TRI-WATCH	15
FEATURES	ii	■ Description	15
PRECAUTION	iii	■ Operation	15
TABLE OF CONTENTS	iv	7 SET MODE	16–20
1 OPERATING RULES	1	■ SET mode programming	16
2 SUPPLIED ACCESSORIES AND ATTACHMENTS ...	2–3	■ SET mode items	17
■ Supplied accessories	2	8 BATTERY CHARGING	21–24
■ Attachments	2	■ Battery charging	21
3 PANEL DESCRIPTION	4–6	■ Battery cautions	21
■ Front, top and side panels	4	■ Optional battery case	22
■ Function display	5	■ Optional battery chargers	23
4 BASIC OPERATION	7–12	9 OPTIONAL SWIVEL BELT CLIP	25
■ Channel selection	7	■ MB-87 contents	25
■ Adjusting the volume level	9	■ To attach	25
■ Adjusting the squelch level	9	■ To detach	25
■ Receiving and transmitting	10	10 TROUBLESHOOTING	26
■ Call channel programming	11	11 CHANNEL LIST	27
■ Lock function	12	12 SPECIFICATIONS	28
■ Automatic backlighting	12	13 OPTIONS	29
■ Monitor function	12	14 DOC.....	30

◇ **Priorities**

- Read all rules and regulations pertaining to priorities and keep an up-to-date copy handy. Safety and distress calls take priority over all others.
- You must monitor Channel 16 when you are not operating on another channel.
- False or fraudulent distress calls are prohibited under law.

◇ **Privacy**

- Information overheard but not intended for you cannot lawfully be used in any way.
- Indecent or profane language is prohibited.

◇ **Radio licenses**

(1) SHIP STATION LICENSE

When your craft is equipped with a VHF FM transceiver, you must have a current radio station license before using the transceiver. It is unlawful to operate a ship station which is not licensed.

Inquire through your dealer or the appropriate government agency for a Ship-Radiotelephone license. This license includes the call sign which is your craft's identification for radio purposes.

(2) OPERATOR'S LICENSE

A restricted Radiotelephone Operator Permit is the license most often held by small vessel radio operators when a radio is not required for safety purposes.

The Restricted Radiotelephone Operator Permit must be posted near the transceiver or be kept with the operator. Only a licensed radio operator may operate a transceiver.

However, non-licensed individuals may talk over a transceiver if a licensed operator starts, supervises, ends the call and makes the necessary log entries.

A current copy of the applicable government rules and regulations is only required to be on hand for vessels in which a radio telephone is compulsory. However, even if you are not required to have these on hand it is your responsibility to be thoroughly acquainted with all pertinent rules and regulations.

■ Supplied accessories

The following accessories are supplied:	Qty.
• Flexible antenna	1
• Handstrap	1
• Belt clip	1
• Battery pack	1
• Battery charger (with 2 screws)	1
• AC adapter*1	1
• Top plate (double-sided tape)*2	1

*1 Not supplied with some versions.

*2 Use the top plate as a spare. Ask your dealer for details.

■ Attachments

◇ Flexible antenna

Connect the supplied flexible antenna to the antenna connector.

CAUTION:

- **NEVER** carry the transceiver by holding the antenna.
- Transmitting without an antenna may damage the transceiver.

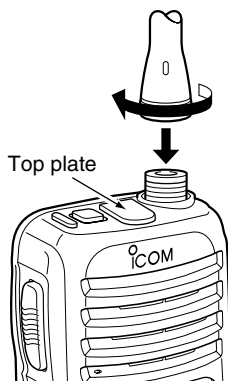

◇ Handstrap

Pass the handstrap through the loop on the side of the transceiver as illustrated at right. Facilitates carrying.

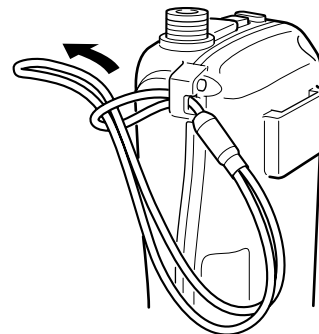

◇ Belt clip

Attach the belt clip to the transceiver as illustrated below.

To attach the belt clip

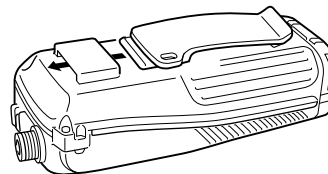

To remove the belt clip

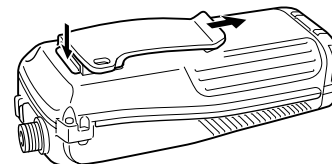

2 SUPPLIED ACCESSORIES AND ATTACHMENTS

◆ Battery pack

To remove the battery pack:

Turn the screw counterclockwise, then pull the battery pack in the direction of the arrow as shown below.

To attach the battery pack:

Insert the battery pack in the IC-M31 completely, then turn the screw clockwise.

NEVER remove or insert the battery pack when the transceiver is wet or soiled. This may result water or dust getting into the transceiver/battery pack and may result in the transceiver being damaged.

NOTE: When removing or attaching the battery pack, use a coin or flat-blade screwdriver to loosen or tighten the bottom screw.

CAUTION: When attaching or removing a battery pack, make sure the rubber seal is set in the groove of the battery pack correctly. If the seal is not neatly in the groove it may be damaged when attaching the battery pack. If the seal is damaged, waterproofing is not guaranteed.

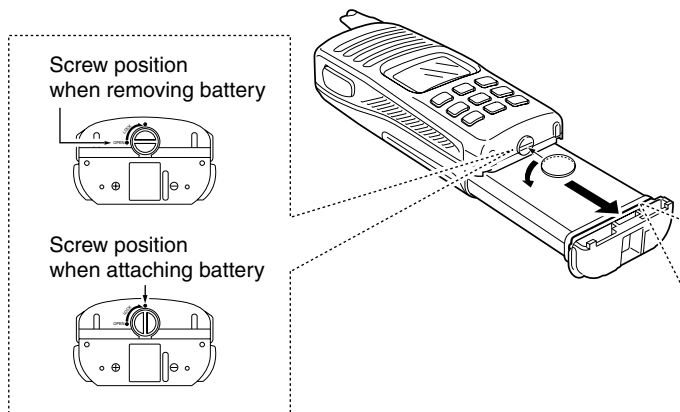

NOTE: When attaching a battery pack, make sure dust or else does not adhere to the rubber seal. If dust or else is on the seal when attaching a battery pack, the water resistant may be reduced.

Make sure both the rubber seal (purple) is set to the groove correctly and dust or else does not adhere to it.

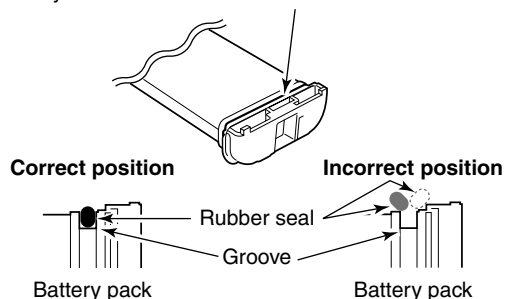

■ Front, top and side panels

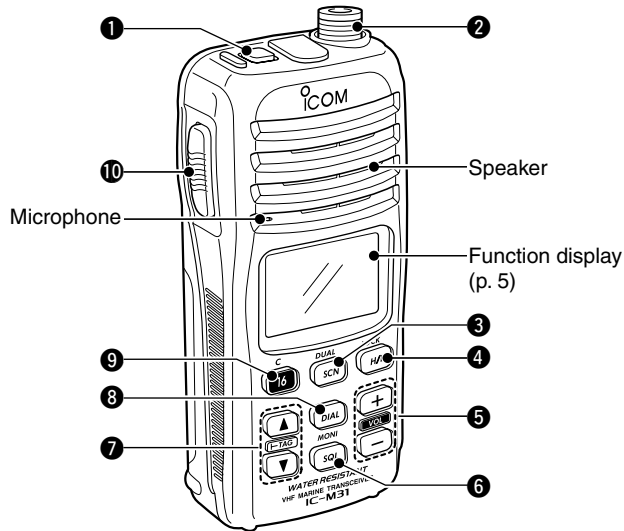

1 POWER SWITCH [PWR]

Push and hold to turn power ON and OFF.

2 ANTENNA CONNECTOR (p. 2)

Connects the supplied antenna.

3 SCAN/DUAL KEY [SCN•DUAL]

- Starts and stops normal or priority scan. (p. 14)
- Enters watch mode when pushed for 1 sec. (p. 15)
- Exits watch mode when pushed during watch operation. (p. 15)

4 TRANSMIT POWER/LOCK KEY [H/L•LOCK]

- Selects high or low power when pushed. (p. 10)
- Toggles the lock function ON/OFF when pushed for 1 sec. (p. 12)

5 VOLUME UP/DOWN KEYS [+]/[-]•[VOL]

- Adjusts the volume level. (p. 9)
- After pushing [SQL•MONI], push to adjust the squelch level. (p. 9)

6 SQUELCH KEY [SQL•MONI]

- Push this key, then adjust the squelch level with [+]/[-]. (p. 9)
- Manually opens the squelch for monitoring the channel while pushed and held. (p. 12)
- While pushing this key, turn power ON to enter the set mode. (p. 16)

☞ Continue to the next page.

3 PANEL DESCRIPTION

■ Front, top and side panels (Continued)

7 CHANNEL UP/DOWN KEYS [▲]/[▼]•[TAG]

- Selects an operating channel. (pgs. 7, 8)
- Selects the SET mode condition of the item. (p. 16)
- Checks tag channels or changes scanning direction during scan. (p. 14)
- Sets or clears the displayed channel as a tag (scanned) channel when pushed both keys for 1 sec. (p. 14)
- While pushing this key, turn power ON to clear all tag channels in the channel group. (p. 14)

8 DIAL/CHANNEL GROUP KEY [DIAL]

- Push to return to the channel selection before selecting the channel 16 or the call channel with [16•C].
- Selects one of 2 regular channel groups in sequence when pushed for 1 sec. (p. 8)
 - International, U.S.A.*1 (or ATIS*2) channels are available.
 - *1 Available for the UK version only
 - *2 Available for the German version only

9 CHANNEL 16 KEY [16•C]

- Selects Channel 16 when pushed. (p. 7)
- Selects the call channel when pushed for 1 sec. (p. 7)
- Enters call channel programming condition when the call channel is selected and this key is pushed for 3 sec. (p. 11)
- Exits set mode when pushed during set mode operation. (p. 16)

10 PTT SWITCH [PTT]

Push and hold to transmit; release to receive.

■ Function display

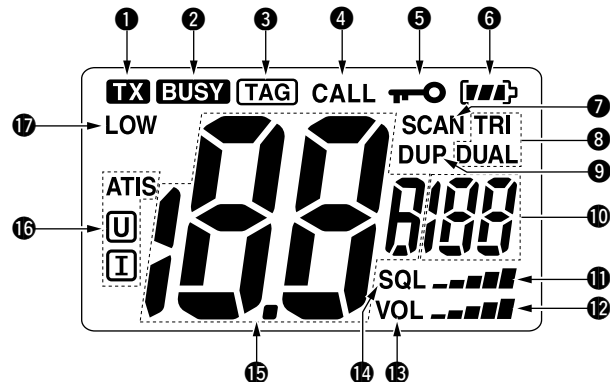

1 TRANSMIT INDICATOR (p. 10)

Appears while transmitting.

2 BUSY INDICATOR

Appears when receiving a signal or when the squelch opens. (p. 10)

“BUSY” blinks while monitoring. (p. 12)

3 TAG CHANNEL INDICATOR (p. 14)

Appears when a tag channel is selected.

4 CALL CHANNEL INDICATOR (p. 7)

Appears when the call channel is selected.

5 LOCK INDICATOR (p. 12)
Appears while the lock function is activated.

6 BATTERY INDICATOR
Indicates remaining battery power.

Indication					
Battery level	Full	Middle	Charging required		No battery

blinks when the battery over charged.

blinks when the battery is exhaustion.

7 SCAN INDICATOR (p. 14)
Blinks while scanning.

8 DUALWATCH/TRI-WATCH INDICATORS (p. 15)
“DUAL” appears during dualwatch; “TRI” appears during tri-watch.

9 DUPLEX INDICATOR
Appears when a duplex channel is selected.

- 10 SUB CHANNEL READOUT**
- Indicates Channel 16 during priority scan, dualwatch or tri-watch. (p. 15)
 - Indicates the SET mode item while in SET mode. (p. 16)
 - Indicates the squelch level while squelch setting. (p. 9)
 - Indicates the volume level while volume setting. (p. 9)

11 SQUELCH LEVEL INDICATOR
Shows the squelch level.

12 VOLUME LEVEL INDICATOR
Shows the volume level.

13 VOLUME LEVEL ADJUSTING INDICATOR
Blinks while adjusting the volume level.

14 SQUELCH LEVEL ADJUSTING INDICATOR
Blinks while adjusting the squelch level.

- 15 CHANNEL NUMBER READOUT**
- Indicates the selected operating channel number.
 - In SET mode, indicates the selected condition.

16 CHANNEL GROUP INDICATOR (p. 8)
“” appears when International; “” appears when U.S.A. (U.K. version only); “ATIS” appears when the channel group in which ATIS function is activated (German version only).

- 17 LOW POWER INDICATOR** (p. 10)
- “LOW” appears when low power is selected.
 - “LOW” blinks when switching forced low power mode because of a high temperature error or low voltage.

■ Channel selection

IMPORTANT: Prior to using the transceiver for the first time, the battery pack must be fully charged for optimum life and operation. To avoid damage to the transceiver, turn the power OFF while charging.

◇ Channel 16

Channel 16 (Distress channel) is used for establishing initial contact with another station and for emergency communications. Channel 16 is automatically monitored during both dualwatch and tri-watch. While standing by, you must monitor Channel 16.

- ① Push [16•C] to select Channel 16.
- ② Push [DIAL] to return to the condition before selecting Channel 16, or push [▲]/[▼] to select the operating channel.

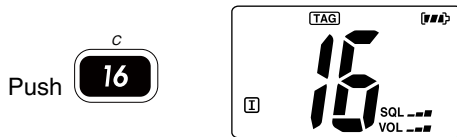

◇ Call channel

Each regular channel group has a separate call channel. In addition, the call channel is monitored during tri-watch. The call channels can be re-programmed (p. 11) and are used to store your most often used channels in each channel group for quick recall.

- ① Push [16•C] for 1 sec. to select the call channel in the selected channel group.
 - “CALL” and the call channel number appear.
 - Each channel group may have its own call channel after programming a call channel. See the “Call channel programming” on p. 11 for details.
- ② Push [DIAL] to return to the condition before selecting the call channel, or push [▲]/[▼] to select the operating channel.

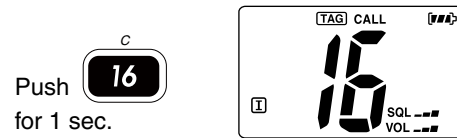

Channel 16 is the default setting.
(depending on version)

◇ International, U.S.A.*1 and ATIS*2 channels

There are 57 (58)*1 International, 58 U.S.A.*1 and 57 ATIS*2 channels. These channel groups may be specified for the operating area.

- ① Push [DIAL] to select a regular channel.
- ② Push [▲]/[▼] to select a channel.
 - “DUP” appears for duplex channels.
- ③ To change the channel group, push [DIAL] for 1 sec.
 - International, U.S.A.*1 and ATIS*2 channels can be selected in sequence.

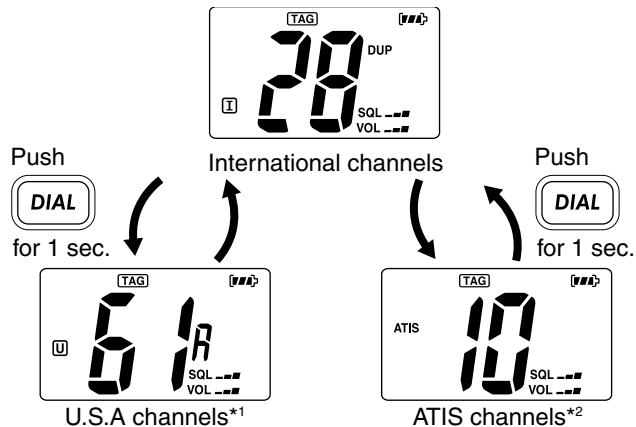

*1 Available for the UK version only

*2 Available for the German version only

■ Adjusting the volume level

The volume level can be adjusted with [+]/[-].

➤ Push [+]/[-] to adjust the volume level.

- “VOL” indicator starts blinking.
- There are 32 volume levels to choose.
- When no key is pushed for 5 sec., the transceiver returns to normal condition.

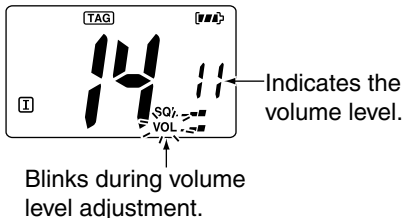

■ Adjusting the squelch level

The IC-M31 has a squelch level adjustment, even though there is no control knob for it. In order to receive signals properly, as well as for the scan to function effectively, the squelch must be adjusted to the proper level.

① Push [SQL•MONI], then adjust the squelch level with [+]/[-].

- “SQL” indicator starts blinking.
- There are 11 squelch levels to choose from: “OP” is completely open; “10” is tight squelch; “1” is loose squelch level.
- When no key is pushed for 5 sec., the transceiver returns to normal condition.

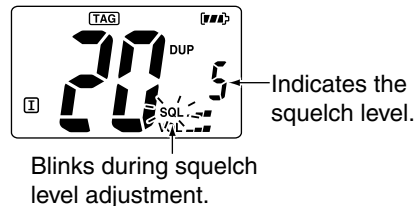

② Push [SQL•MONI] again to return to normal condition.

✓ CONVENIENT!

The squelch level adjustment key can be selected from [▲]/[▼] and [+]/[-] with following operation.

- While pushing both [SQL•MONI] and [▲], turn the power ON to set [▲]/[▼] to the squelch level adjustment key.
- While pushing both [SQL•MONI] and [+], turn the power ON to set [+]/[-] to the squelch level adjustment key.

■ Receiving and transmitting

/// **CAUTION:** Transmitting without an antenna may damage the transceiver.

- ① Push and hold [PWR] to turn power ON.
- ② Set the volume and squelch levels.
 - ➔ Push [SQL•MONI], and push [-] to open the squelch.
 - ➔ Push [SQL•MONI] to stop “SQL” indicator blinking, then push [+]/[-] to set the volume level.
 - ➔ Push [SQL•MONI], and push [+]/[-] to set the squelch level.
- ③ Push [▲]/[▼] to select the desired channel.
 - When receiving a signal, “**BUSY**” appears and audio is emitted from the speaker.
 - Further adjustment of the volume may be necessary at this point.
- ④ Push [H/L•LOCK] to select the output power if necessary.
 - “LOW” appears when low power is selected; no indication when high power is selected.
 - Choose low power to conserve battery power, choose high power for longer distance communications.
 - Some channels are for low power only.
- ⑤ Push and hold [PTT] to transmit, then speak into the microphone.
 - “**TX**” appears.
 - Channel 70 cannot be used for transmission.
- ⑥ Release [PTT] to receive.

/// **IMPORTANT:** To maximize the readability of your transmitted signal, pause a few sec. after pushing [PTT], hold the microphone 5 to 10 cm from your mouth and speak into the microphone at a normal voice level.

/// **NOTE:** The transceiver has a power save function to conserve the battery power. The power save function activates automatically when no signal is received for 5 sec.

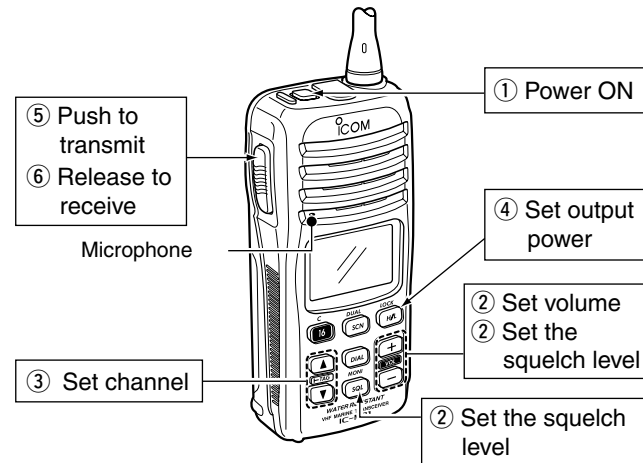

4 BASIC OPERATION

■ Call channel programming

The call channel key is used to select the default channel, however, you can program your most often-used channel in each channel group for quick recall.

- ① Push [DIAL] for 1 sec. several times to select the desired channel group (INT, USA, ATIS) to be programmed.

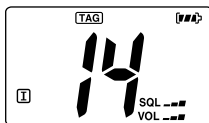

- ② Push [16•C] for 1 sec. to select the call channel.
 - "CALL" and call channel number appear.

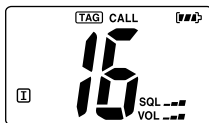

- ③ Push [16•C] again for 3 sec. (until a long beep changes to 2 short beeps) to enter call channel programming condition.
 - Call channel number to be programmed flashes.

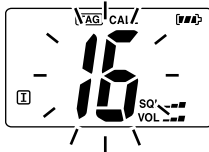

- ④ Push [▲]/[▼] to select the desired channel.

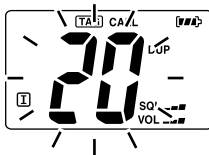

- ⑤ Push [16•C] to program the displayed channel as the call channel.
 - The call channel number stop flashing.



■ Lock function

This function electronically locks all keys (except for [+]/[-], [PTT], [SQL•MONI] and [H/L•LOCK]) to prevent accidental channel changes and function access.

- ➔ Push [H/L•LOCK] for 1 sec. to turn the lock function ON and OFF.

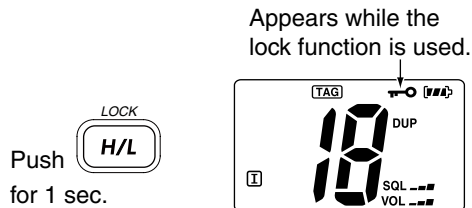

■ Monitor function

The monitor function releases the noise squelch mute. See p. 18 for details of the monitor switch action.

- ➔ Push [SQL•MONI] for 1 sec. to activate the monitor function.
 - “**BUSY**” blinks and audio is emitted.

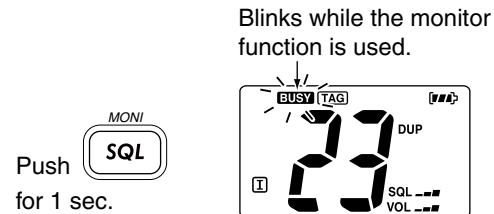

■ Automatic backlighting

This function is convenient for nighttime operation. The automatic backlighting can be activated in SET mode. (p. 18)

- ➔ Push any key except for [PTT] to turn the backlighting ON.
 - The backlighting is automatically turned OFF after 5 sec. of inactivity.

■ Scan types

Scanning is an efficient way to locate signals quickly over a wide frequency range. The transceiver has priority scan and normal scan.

In addition, an auto scan function is available for standby convenience.

Set the tag channels (scanned channel) before scanning. Clear the tag channels which inconveniently stop scanning, such as digital communications.

/// Choose priority or normal scan in SET mode. (p. 17)

PRIORITY SCAN

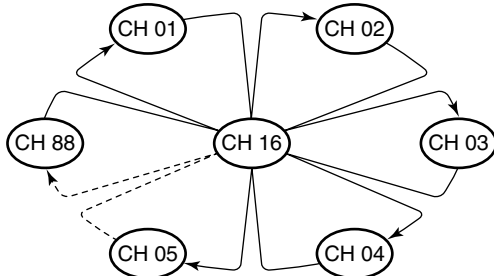

Priority scan searches through all tag channels in sequence while monitoring Channel 16. When a signal is detected on Channel 16, scan pauses until the signal disappears; when a signal is detected on a channel other than Channel 16, scan becomes dualwatch until the signal disappears.

NORMAL SCAN

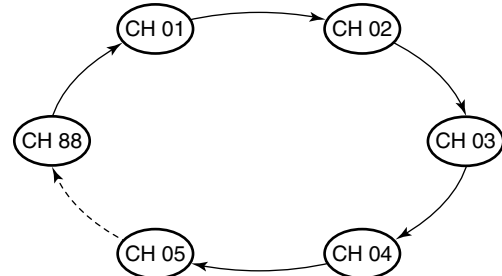

Normal scan, like priority scan, searches through all tag channels in sequence. However, unlike priority scan, Channel 16 is not checked unless Channel 16 is set as a tag channel.

■ Setting tag channels

For more efficient scanning, add desired channels as tag channels or clear the tag for unwanted channels. Non-tag channels will be skipped during scanning.

Tag channels can be assigned to each channel group (INT, USA, ATIS) independently. (Depending on version)

- ① Select the desired channel group (INT, USA, ATIS) by pushing [DIAL] for 1 sec., if desired.
- ② Select the desired channel to set as a tag channel.
- ③ Push both [▲] and [▼] for 1 sec. to set the displayed channel as a tag channel.
 - “TAG” appears in the function display.
- ④ To cancel the tag channel setting, push both [▲] and [▼] for 1 sec.
 - “TAG” disappears.

✓ Clearing all tag channels in the selected channel group

While pushing and holding both [▲] and [▼], turn power ON to clear all tag channels in the channel group.

■ Starting a scan

Set the priority scan function, scan resume timer and auto scan function in advance, using SET mode. (pgs. 17, 18)

- ① Select the desired channel group (INT, USA, ATIS) by pushing [DIAL] for 1 sec., if desired. (Available for the UK and German version only)
- ② Push [SCN•DUAL] to start priority or normal scan.
 - “SCAN” blinks in the function display.
 - “16” appears on the sub channel readout during priority scan.
 - When a signal is received, scan pauses until the signal disappears or resumes after pausing 5 sec. according to scan resume timer setting. (Channel 16 is still monitored during priority scan.)
 - Push [▲]/[▼] to check the scanning tag channels, change the scanning direction or resume the scan manually.
- ③ To stop the scan, push [SCN•DUAL].
 - “SCAN” disappears.
 - Pushing [PTT], [16•C] or [DIAL] also stops the scan.

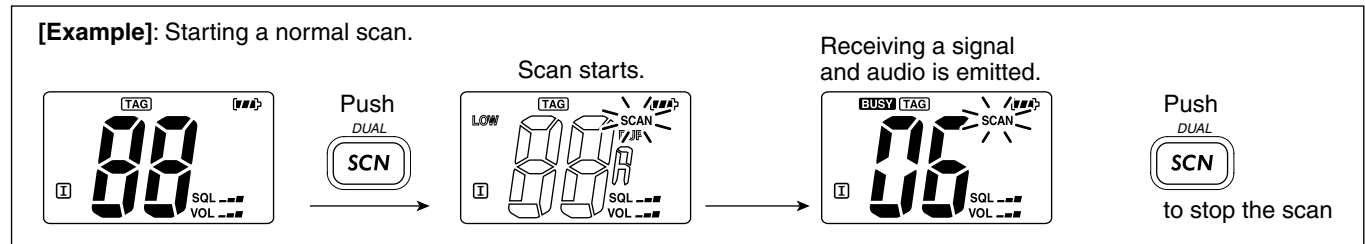

■ Description

Dualwatch monitors Channel 16 while you are receiving another channel; tri-watch monitors Channel 16 and the call channel while receiving another channel.

DUALWATCH/TRI-WATCH SIMULATION

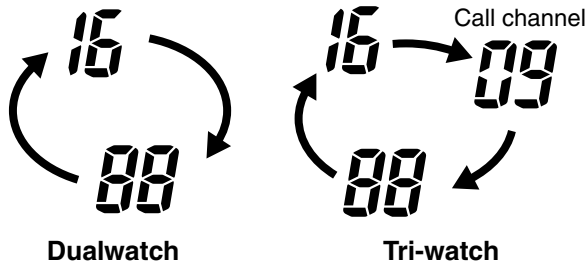

- If a signal is received on Channel 16, dualwatch/tri-watch pauses on Channel 16 until the signal disappears.
- If a signal is received on the call channel during tri-watch, tri-watch becomes dualwatch until the signal disappears.
- To transmit on the selected channel during dualwatch/tri-watch, push and hold [PTT].

■ Operation

- ① Select the desired operating channel.
- ② Push [SCN•DUAL] for 1 sec. to start dualwatch or tri-watch (depending on SET mode setting).
 - “DUAL” blinks during dualwatch; “TRI” blinks during tri-watch.
 - A beep tone sounds when a signal is received on Channel 16.
 - Tri-watch becomes dualwatch when receiving a signal on the call channel.
- ③ To cancel dualwatch/tri-watch, push [SCN•DUAL] again.

[Example]: Operating tri-watch on INT channel 07.

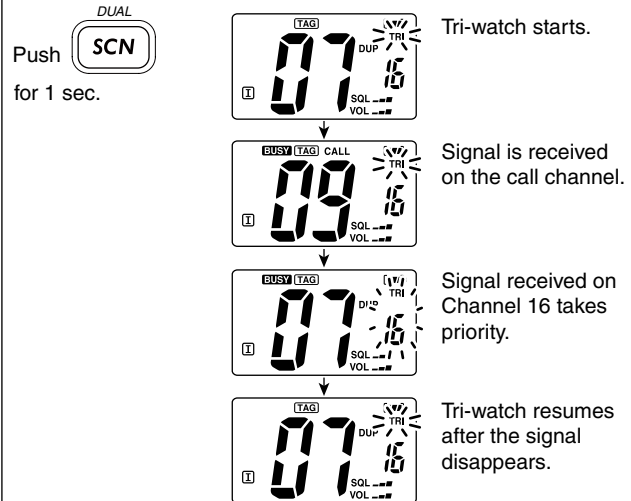

■ SET mode programming

SET mode is used to change the condition of 11 transceiver functions: Beep tone function, Priority scan function, Scan resume timer, Scan resume timer, Auto scan function, Dual/Tri-watch function, monitor switch action, Automatic backlighting, LCD contrast selection, Power save function, Self check function and Battery voltage indicator.

◇ SET mode operation

- ① Turn power OFF.
- ② While pushing [SQL•MONI], turn power ON to enter SET mode.
 - “bp” appears.
- ③ Push [SQL•MONI] or [SQL•MONI] and [▲] to select the desired item, if necessary.
- ④ Push [▲]/[▼] to select the desired condition of the item.
- ⑤ To exit SET mode, push [16•C].

◇ SET MODE ITEMS The displays show the default settings, and the selected item is displayed in the dotted circle.

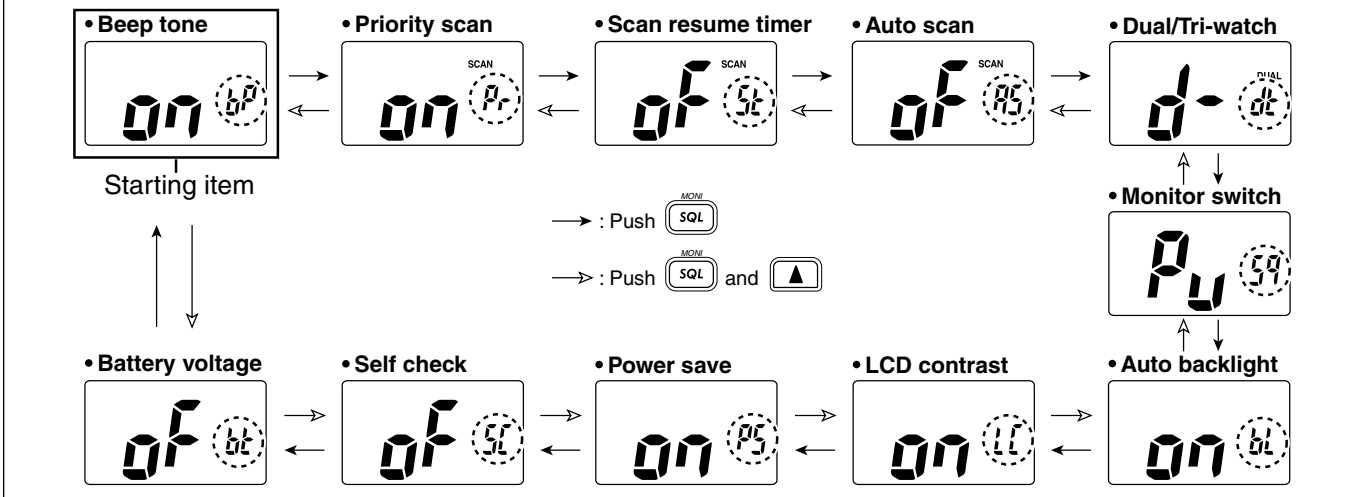

■ SET mode items

◇ Beep tone function “bP”

You can select silent operation by turning the beep tones OFF, or you can have 2 types of confirmation beeps sound at the push of a switch. When ON is selected, a fixed beep (Pi) sounds, and when US is selected, the preset beeps (e.g. do, re, mi) sound.

- Beep tone synchronises with the volume level.
- The beeps sound during call channel programming even if this function is turned OFF.



Beep tone ON (default)



User beep



Beep tone OFF

◇ Priority scan function “Pr”

The transceiver has 2 scan types—normal (OFF) and priority (ON) scans. Normal scan searches all tag channels in the selected channel group. Priority scan searches all tag channels in sequence while monitoring Channel 16.

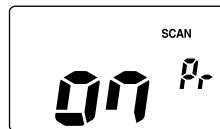

Priority scan (default)

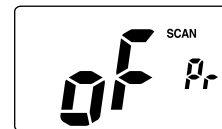

Normal scan

◇ Scan resume timer “St”

The scan resume timer can be set as a pause (OFF) or timer scan (ON). When OFF is selected, the scan pauses until a received signal disappears. When ON is selected, the scan pauses for 5 sec. after receiving a signal and then resumes even if the signal has been received.

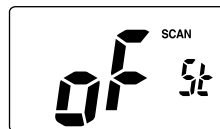

Scan resume timer OFF (default)



Scan resume timer ON

◇ **Auto scan function “AS”**

The auto scan function starts the desired scan automatically when no signal is received, and no operation is performed for 30 sec.



Auto scan OFF (default)



Auto scan ON

◇ **Dual/Tri-watch function “dt”**

This item selects dual or tri-watch as desired. See p. 15 for details.

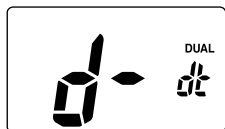

Dualwatch function (default)



Tri-watch function

◇ **Monitor switch action “Sq”**

The monitor switch action cuts off the squelch function temporarily. This switch action contains PUSH (Pu) or HOLD (Ho) settings as shown below.

- Pu (PUSH): After pushing the [SQL•MONI] for 1 sec., the squelch opens and emits audio. The squelch is held open while continuously pushing and holding [SQL•MONI]. (default)
- Ho (HOLD): After pushing the [SQL•MONI] for 1 sec., the squelch opens and emits audio even [SQL•MONI] is released. To close the squelch, push any key.



Push setting (default)



Hold setting

◇ **Automatic backlighting “bl”**

This function is convenient for nighttime operation. The automatic backlighting turns the backlighting ON when any key except for [PTT] is pushed.

- The backlighting is automatically turned OFF after 5 sec. of inactivity.



Auto backlighting ON (default)



Auto backlighting OFF

7 SET MODE

◇ LCD contrast selection “LC”

The contrast of the LCD can be turned ON (high contrast) and OFF (low contrast).



LCD contrast ON
(default)



LCD contrast OFF

◇ Power save function “PS”

The power save function reduces current drain by deactivating the receiver circuit for preset intervals.

- ON : The power save function is turned ON. The power save function will activate when no signal is received, and no operation is performed for 5 sec.
- OFF: The power save function is turned OFF.



Power save ON
(default)



Power save OFF

◇ Self check function “SC”

The self check function checks transceiver conditions by itself, and informs you in case a problem is found. The following items are checked after the power is turned ON, then it switches to operation mode.

- Temperature : Outside of -25°C to $+65^{\circ}\text{C}$ (approx.)
- Connected battery voltage
- Water intrusion



Self check OFF (default)



Self check ON

When error messages as shown below are displayed, see troubleshooting for advice. (p. 26)

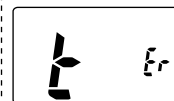

Temperature error



Battery voltage error



Water intrusion error

◇ **Battery voltage indicator “bt”**

The voltage of the connected battery pack can be turned ON (displayed for 2 sec.) or OFF (non-displayed) after power is turned ON.



Battery voltage indication OFF (default)

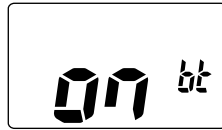

Battery voltage indication ON

SET MODE LIST

Function	Indication	Switch
Beep tone function	"bP"	OFF / ON* / US
Priority scan function	"Pr"	OFF / ON*
Scan resume timer	"St"	OFF* / ON
Auto scan function	"AS"	OFF* / ON
Dual/Tri-watch function	"dt"	Dual* / Tri
Monitor switch action	"Sq"	Push* / Hold
Automatic backlighting	"bL"	OFF / ON*
LCD contrast selection	"LC"	OFF / ON*
Power save function	"PS"	OFF / ON*
Self check function	"SC"	OFF* / ON
Battery voltage indicator	"bt"	OFF* / ON

*Default setting

■ Battery charging

/// Please refer to the BC-162 instruction manual when charging the BP-252 LI-ION BATTERY PACK with the BC-162 DESKTOP CHARGER.

Prior to using the transceiver for the first time, the battery pack must be fully charged for optimum life and operation.

/// **CAUTION:** To avoid damage to the transceiver, turn the power OFF while charging.

- Recommended temperature range for charging: +10°C to +40°C
- Use the specified chargers (BC-150, BC-119N and BC-121N). **NEVER** use another manufacture's charger.
- Use the supplied AC adapte for BC-150. **NEVER** use another manufacture's adapters.

/// **NEVER** connect DC power to the battery case when installing alkaline batteries. Such a connection will damage the transceiver.

■ Battery cautions

CAUTION! NEVER insert battery pack/transceiver (with the battery pack attached) with wet or soiled into the charger. This may result in corrosion of the charger terminals or damage to the charger. The charger is not waterproof and water can easily get into it.

NEVER incinerate used battery pack. Internal battery gas may cause an explosion.

NEVER immerse batteries in water. If the battery pack becomes wet, be sure to wipe it dry BEFORE attaching it to the transceiver.

NEVER short the terminals of the battery pack. Also, current may flow into nearby metal objects, such as a necklace, etc. Therefore, be careful when carrying with, or placing near metal objects, carrying in handbags, etc.

If your battery pack seem to have no capacity even after being charged, completely discharge them by leaving the power ON overnight. Then, fully charge the battery pack again. If the batteries still do not retain a charge (or very little), new battery pack must be purchased.

◇ Charging connections

- ① Attach the BC-150 to a flat surface, such as desk or cabin, etc., if desired.
- ② Connect the AC adapter as shown below.
- ③ Insert the battery pack with/without the transceiver into the charger.
 - The charge indicator lights green.
- ④ Charge the battery pack approx. 8 hours, depending on the remaining power condition.

DO NOT charge BP-224 more than 12 hours. Otherwise, BP-224 will be damaged. BP-224 must be charged for 8–12 hours only.

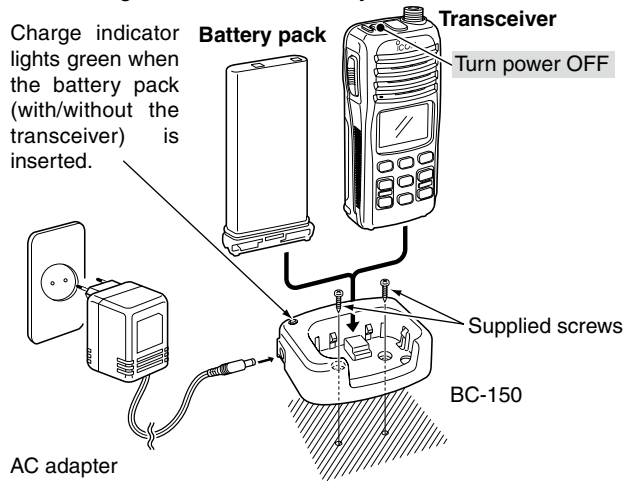

AC adapter
(A different type, or no AC adapter is supplied, depending on the version.)

■ Optional battery case

When using a battery case attached to the transceiver, install 6 × AA(R6) size alkaline batteries as illustrated below.

- ① Remove the battery case from the transceiver.
- ② Install 6 × AA(R6) size alkaline batteries.
 - Be sure to observe the correct polarity.

CAUTION:

- When installing batteries, make sure they are all the same brand, type and capacity. Also, do not mix new and old batteries together.
- Keep battery contacts clean. It's a good idea to clean battery terminals once a week.

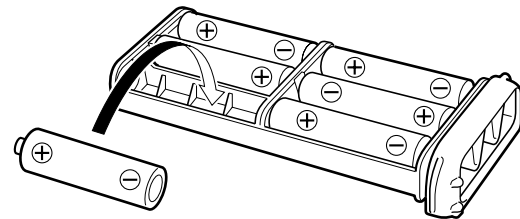

8 BATTERY CHARGING

■ Optional battery chargers

◇ AD-103 installation

① Install the AD-103 desktop charger adapter into the holder space of the BC-119N/121N.

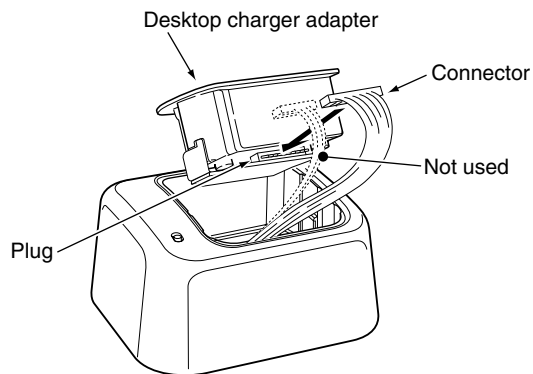

② Connect the plugs of the BC-119N/121N to the AD-103 desktop charger adapter with the connector, then install the adapter into the charger with the supplied screws.

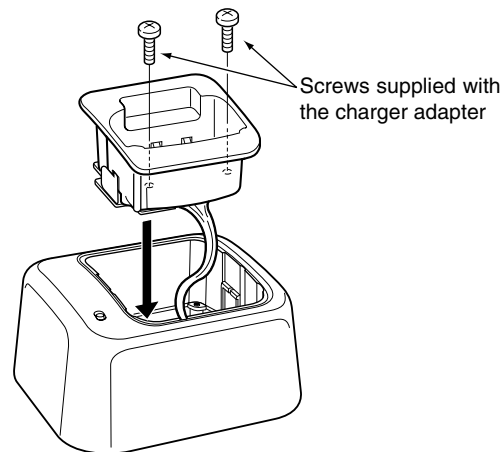

◇ **Rapid charging with the BC-119N+AD-103**

The optional BC-119N provides rapid charging of battery packs. The following are additionally required.

- AD-103 charger adapter
- An AC adapter (not supplied with BC-119N depending on version) or the DC cable (OPC-515L/CP-17L)

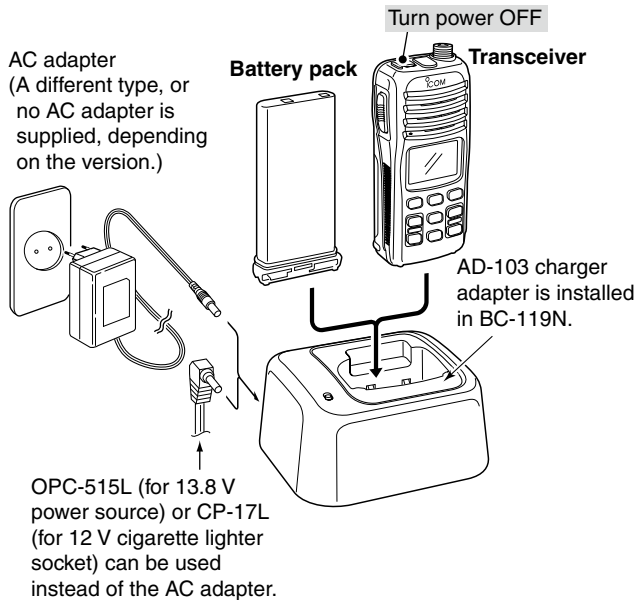

◇ **Rapid charging with the BC-121N+AD-103**

The optional BC-121N allows up to 6 battery packs to be charged simultaneously. The following are additionally required.

- Six AD-103 charger adapters
- An AC adapter (BC-157) or the DC power cable (OPC-656)

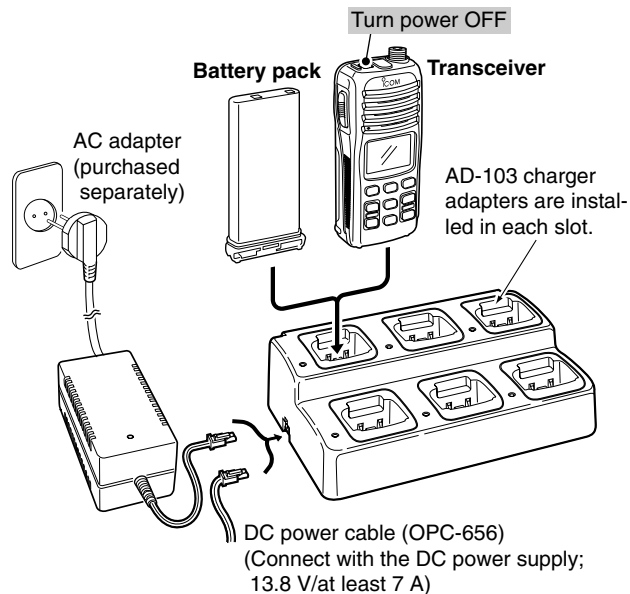

■ MB-87 contents

	Qty.
① Belt clip	1
② Base clip	1

■ To attach

- ① Slide the base clip into the plastic loop on the back of the transceiver as illustrated below.

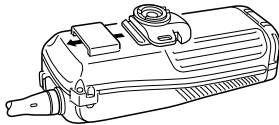

- ② Clip the belt clip to a part of your belt and insert the transceiver into the belt clip until the base clip fitting into the groove.

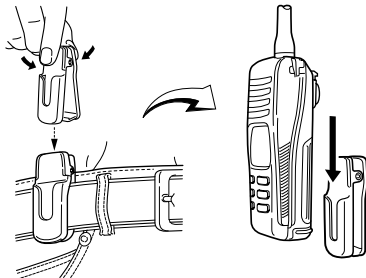

- ③ Once the transceiver is locked in place, it swivels as illustrated below.

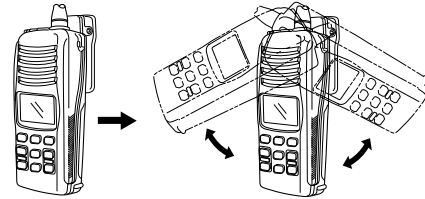

■ To detach

- ➔ Turn the transceiver upside down in the direction of the arrow and pull out from the belt clip.

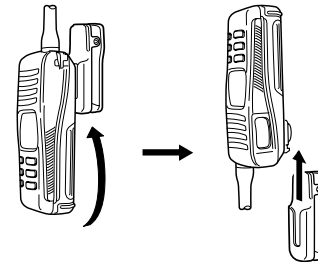

CAUTION:
HOLD THE TRANSCEIVER TIGHTLY, WHEN HANGING OR DETACHING THE TRANSCEIVER FROM THE BELT CLIP.

Otherwise the transceiver may not be attached to the belt clip or swivelled properly if the transceiver is accidentally dropped and the base clip is scratched or damaged.

PROBLEM	POSSIBLE CAUSE	SOLUTION	REF.
The transceiver does not turn ON.	<ul style="list-style-type: none"> • The battery is exhausted. • Bad connection to the battery pack. 	<ul style="list-style-type: none"> • Recharge the battery pack. • Check the connection to the transceiver. 	<p>p. 21</p> <p>p. 3</p>
No sound from speaker.	<ul style="list-style-type: none"> • Squelch level is too deep. • Volume level is too low. • Speaker has been exposed to water. 	<ul style="list-style-type: none"> • Set squelch to the threshold point. • Push [+]/[-] to set a suitable level. • Drain water from the speaker. 	<p>p. 9</p> <p>p. 9</p> <p>—</p>
Transmitting is impossible, or high power cannot be selected.	<ul style="list-style-type: none"> • Some channels are for low power or receive only. • The battery is exhausted. • The battery over charged. • The output power is set to low. 	<ul style="list-style-type: none"> • Change channels. • Recharge the battery pack. • Verify the battery voltage is correct. • Push [H/L•LOCK] to select high power. 	<p>pgs. 7, 8, 27</p> <p>p. 21</p> <p>—</p> <p>p. 10</p>
The displayed channel cannot be changed.	<ul style="list-style-type: none"> • Lock function is activated. 	<ul style="list-style-type: none"> • Push [H/L•LOCK] for 1 sec. to cancel the function. 	p. 12
Scan does not start.	<ul style="list-style-type: none"> • “TAG” channels are not programmed. 	<ul style="list-style-type: none"> • Set the desired channels as “TAG” channels. 	p. 14
No beeps.	<ul style="list-style-type: none"> • Beep tones are turned OFF. 	<ul style="list-style-type: none"> • Set the beep tones to ON (Fix Beep/User Beep) in SET mode. 	p. 17
Self check error. (Temperature)	<ul style="list-style-type: none"> • The temperature is outside of -25°C to $+65^{\circ}\text{C}$ (approx). 	<ul style="list-style-type: none"> • Leave the transceiver at room temperature for a while. Turn the power ON to check if the internal temperature has returned to normal. 	—
Self check error. (Battery voltage)	<ul style="list-style-type: none"> • The connected battery pack’s voltage is more than 11 V. 	<ul style="list-style-type: none"> • Verify the battery voltage is correct. 	—
Self check error. (Water intrusion)	<ul style="list-style-type: none"> • Water has entered the transceiver. 	<ul style="list-style-type: none"> • Have the transceiver checked at your local distributor or dealer to see whether the transceiver works properly or not. 	—

11 CHANNEL LIST

• International channels

CH	Frequency (MHz)		CH	Frequency (MHz)		CH	Frequency (MHz)		CH	Frequency (MHz)		CH	Frequency (MHz)		CH	Frequency (MHz)	
	Transmit	Receive		Transmit	Receive		Transmit	Receive		Transmit	Receive		Transmit	Receive		Transmit	Receive
01	156.050	160.650	11	156.550	156.550	21	157.050	161.650	61	156.075	160.675	71	156.575	156.575	81	157.075	161.675
02	156.100	160.700	12	156.600	156.600	22	157.100	161.700	62	156.125	160.725	72	156.625	156.625	82	157.125	161.725
03	156.150	160.750	13	156.650	156.650	23	157.150	161.750	63	156.175	160.775	73	156.675	156.675	83	157.175	161.775
04	156.200	160.800	14	156.700	156.700	24	157.200	161.800	64	156.225	160.825	74	156.725	156.725	84	157.225	161.825
05	156.250	160.850	15 [†]	156.750	156.750	25	157.250	161.850	65	156.275	160.875	75 [†]	156.775	156.775	85	157.275	161.875
06	156.300	156.300	16	156.800	156.800	26	157.300	161.900	66	156.325	160.925	76 [†]	156.825	156.825	86	157.325	161.925
07	156.350	160.950	17 [†]	156.850	156.850	27	157.350	161.950	67	156.375	156.375	77	156.875	156.875	87	157.375	157.375
08	156.400	156.400	18	156.900	161.500	28	157.400	162.000	68	156.425	156.425	78	156.925	161.525	88	157.425	157.425
09	156.450	156.450	19	156.950	161.550	37A [‡]	157.850	157.850	69	156.475	156.475	79	156.975	161.575			
10	156.500	156.500	20	157.000	161.600	60	156.025	160.625	70	Rx only	156.525	80	157.025	161.625			

• USA channels (for U.K. version only)

CH	Frequency (MHz)		CH	Frequency (MHz)		CH	Frequency (MHz)		CH	Frequency (MHz)		CH	Frequency (MHz)		CH	Frequency (MHz)	
	Transmit	Receive		Transmit	Receive		Transmit	Receive		Transmit	Receive		Transmit	Receive		Transmit	Receive
01A	156.050	156.050	12	156.600	156.600	22A	157.100	157.100	64A	156.225	156.225	77 [†]	156.875	156.875	86	157.325	161.925
--	---	---	13 [†]	156.650	156.650	23A	157.150	157.150	65A	156.275	156.275	78A	156.925	156.925	86A	157.325	157.325
03A	156.150	156.150	14	156.700	156.700	24	157.200	161.800	66A	156.325	156.325	79A	156.975	156.975	87	157.375	161.975
--	---	---	15 [†]	156.750	156.750	25	157.250	161.850	67 [†]	156.375	156.375	80A	157.025	157.025	87A	157.375	157.375
05A	156.250	156.250	16	156.800	156.800	26	157.300	161.900	68	156.425	156.425	81A	157.075	157.075	88	157.425	162.025
06	156.300	156.300	17 [†]	156.850	156.850	27	157.350	161.950	69	156.475	156.475	82A	157.125	157.125	88A	157.425	157.425
07A	156.350	156.350	18A	156.900	156.900	28	157.400	162.000	70	Rx only	156.525	83A	157.175	157.175			
08	156.400	156.400	19A	156.950	156.950	37A	157.850	157.850	71	156.575	156.575	84	157.225	161.825			
09	156.450	156.450	20	157.000	161.600	61A	156.075	156.075	72	156.625	156.625	84A	157.225	157.225			
10	156.500	156.500	20A	157.000	157.000	--	---	---	73	156.675	156.675	85	157.275	161.875			
11	156.550	156.550	21A	157.050	157.050	63A	156.175	156.175	74	156.725	156.725	85A	157.275	157.275			

[†]Low power only. [‡]Available for UK version only.

◇ GENERAL

- Frequency coverage : Transmit 156.000–161.450 MHz
Receive 156.000–163.425 MHz
- Mode : FM (16K0G3E)
- Channel spacing : 25 kHz
- Power supply requirement : BP-223, BP-224, and BP-252 only
- Current drain (at 7.5 V DC) : TX at 5 W 1.5 A typical
TX at 1 W 0.7 A typical
Max. audio 200 mA typical
Power save 20 mA typical
- Frequency stability : ±1.5 kHz (–15°C to +55°C)
- Useable temperature range : –15°C to +55°C
- Dimensions : 61(W) × 135(H) × 41(D) mm
(projections not included)
- Weight (approx.; with BP-224) : 360 g

◇ TRANSMITTER

- Output power (at 7.5 V DC) : 5 W (Hi), 1 W (Low) or
1 W (Hi), 0.5 W (Low) <German ver.>
- Modulation system : Variable reactance frequency
- Max. frequency deviation : ±5 kHz
- Adjacent channel power : 70 dB
- Spurious emissions : Less than 0.25 μW

◇ RECEIVER

- Receive system : Double-conversion superheterodyne
- Sensitivity (20 dB SINAD) : –2 dBμ EMF typical
- Squelch sensitivity : 0 dBμ EMF typical (at threshold)
- Intermodulation rejection ratio : 68 dB
- Spurious response rejection ratio : 70 dB
- Adjacent channel selectivity : 70 dB
- Audio output power : 0.2 W at 10% distortion with an
8 Ω load

**All stated specifications are subject to change without notice or obligation.
Specifications are measured in accordance with EN 301-178.**

13 OPTIONS

◇ BATTERY CASE AND PACK

- **BP-223** BATTERY CASE
Battery case for 6 × AA (R6) alkaline cells.
- **BP-224** Ni-Cd BATTERY PACK
Voltage : 7.2 V
Capacity : 750 mAh
- **BP-252** LI-ION BATTERY PACK
Voltage : 7.4 V
Capacity : 950 mAh (minimum) / 980 mAh (typical)

◇ CHARGERS

- **BC-119N** DESKTOP CHARGER + **AD-103** CHARGER ADAPTER
+ **BC-145** AC ADAPTER
For rapid charging of battery packs. An AC adapter is supplied with the charger depending on versions.
Charging time: approx. 1.5 to 2 hours
- **BC-121N** MULTI-CHARGER + **AD-103** CHARGER ADAPTER (6 pcs.)
+ **BC-157** AC ADAPTER
For rapid charging of up to 6 battery packs (six AD-103's are required) simultaneously. An AC adapter should be purchased separately.
Charging time: approx. 1.5 to 2 hours
- **BC-150** DESKTOP CHARGER + **BC-147** AC ADAPTER
Used for regular charging of battery pack. An AC adapter is supplied with the charger depending on versions.
Charging time: approx. 8 hours
- **BC-162** DESKTOP CHARGER + **BC-145** AC ADAPTER
Used for rapid charging of battery pack.
Charging time: approx. 1 to 2 hours.

◇ BELT CLIPS

- **MB-68** BELT CLIP
- **MB-74N** BELT CLIP
Exclusive alligator-type belt clip.
- **MB-87** SWIVEL BELT CLIP
Belt clip for swivel type.

◇ OTHER OPTIONS

- **CP-17L** CIGARETTE LIGHTER CABLE (For BC-119N)
Allows to charge the battery pack through a 12 V cigarette lighter socket.
- **OPC-515L** (for BC-119N)/**OPC-656** (for BC-121N) DC POWER CABLES
Allows to charge the battery pack using 13.8 V power source instead of the AC adapter.

Icom optional equipment is designed for optimal performance when used with this transceiver. We are not responsible for the transceiver being damaged or any accident caused when using non-Icom optional equipment.

Some options may not be available in some countries. Please ask your dealer for details.

CE CE versions of the IC-M31 which display the “CE” symbol on the serial number seal, comply with the essential requirements of the European Radio and Telecommunication Terminal Directive 1999/5/EC.



This warning symbol indicates that this equipment operates in non-harmonised frequency bands and/or may be subject to licensing conditions in the country of use. Be sure to check that you have the correct version of this radio or the correct programming of this radio, to comply with national licensing requirement.



DECLARATION OF CONFORMITY

We Icom Inc. Japan
1-1-32, Kamiminami, Hirano-ku
Osaka 547-0003, Japan

CE0560 ⚠

Declare on our sole responsibility that this equipment complies with the essential requirements of the Radio and Telecommunications Terminal Equipment Directive, 1999/5/EC, and that any applicable Essential Test Suite measurements have been performed.

Düsseldorf 29th Aug. 2003
Place and date of issue

Kind of equipment: VHF MARINE TRANSCEIVER

Type-designation: IC-M31

Icom (Europe) GmbH
Himmelgeisterstraße 100
D-40225 Düsseldorf
Authorized representative name

Version (where applicable):

This compliance is based on conformity with the following harmonised standards, specifications or documents:

- i) EN 301 178-2 v1.1.1 (2000-8)
- ii) EN 60945 1997
- iii) EN 60950 August 1992, A11 1997
- iv) EN 300 698-2 v1.1.1 (2000-8)
- v) _____
- vi) _____
- vii) _____

T. Maebayashi
General Manager

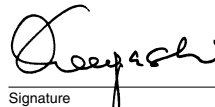
Signature
Icom Inc.

Count on us!

< Intended Country of Use >

- GER FRA ESP SWE
 AUT NED POR DEN
 GBR BEL ITA FIN
 IRL LUX GRE SUI
 NOR