



## INSTRUCTION MANUAL

# VHF MARINE TRANSCEIVER **IC-M2A**

---

This device complies with Part 15 of the FCC Rules. Operation is subject to the follow two conditions: (1) This device may not cause harmful interference, and (2) this device must accept any interference received, including interference that may cause undesired operation.

---

**Icom Inc.**

---



---

## SAFETY TRAINING INFORMATION

---



### WARNING

Your Icom radio generates RF electromagnetic energy during transmit mode. This radio is designed for and classified as “Occupational Use Only”, meaning it must be used only during the course of employment by individuals aware of the hazards, and the ways to minimize such hazards. This radio is NOT intended for use by the “General Population” in an uncontrolled environment.

This radio has been tested and complies with the FCC RF exposure limits for “Occupational Use Only”. In addition, your Icom radio complies with the following Standards and Guidelines with regard to RF energy and electromagnetic energy levels and evaluation of such levels for exposure to humans:

- FCC OET Bulletin 65 Edition 97-01 Supplement C, Evaluating Compliance with FCC Guidelines for Human Exposure to Radio Frequency Electromagnetic Fields.
- American National Standards Institute (C95.1-1992), IEEE Standard for Safety Levels with Respect to Human Exposure to Radio Frequency Electromagnetic Fields, 3 kHz to 300 GHz.
- American National Standards Institute (C95.3-1992), IEEE Recommended Practice for the Measurement of Potentially Hazardous Electromagnetic Fields— RF and Microwave.



### CAUTION

**To ensure that your expose to RF electromagnetic energy is within the FCC allowable limits for occupational use, always adhere to the following guidelines:**

- **DO NOT** operate the radio without a proper antenna attached, as this may damaged the radio and may also cause you to exceed FCC RF exposure limits. A proper antenna is the antenna supplied with this radio by the manufacturer or antenna specifically authorized by the manufacturer for use with this radio.

- **DO NOT** transmit for more than 50% of total radio use time (“50% duty cycle”). Transmitting more than 50% of the time can cause FCC RF exposure compliance requirements to be exceeded. The radio is transmitting when the “TX indicator” lights red. You can cause the radio to transmit by pressing the “PTT” switch.
- **ALWAYS use** Icom authorized accessories (antennas, batteries, belt clips, etc.). Use of unauthorized accessories can cause the FCC RF exposure compliance requirements to be exceeded.
- **ALWAYS keep** the antenna at least 2.5 cm (1 inch) away from the body when transmitting and only use the Icom belt-clips which are listed on page 25 when attaching the radio to your belt, etc., to ensure FCC RF exposure compliance requirements are not exceeded. To provide the recipients of your transmission the best sound quality, hold the antenna at least 5 cm (2 inches) from your mouth, and slightly off to one side.

The information listed above provides the user with the information needed to make him or her aware of RF exposure, and what to do to assure that this radio operates with the FCC RF exposure limits of this radio.

### Electromagnetic Interference/Compatibility

During transmissions, your Icom radio generates RF energy that can possibly cause interference with other devices or systems. To avoid such interference, turn off the radio in areas where signs are posted to do so. **DO NOT** operate the transmitter in areas that are sensitive to electromagnetic radiation such as hospitals, aircraft, and blasting sites.

---

## IN CASE OF EMERGENCY

---

If your vessel requires assistance, contact other vessels and the Coast Guard by sending a distress call on Channel 16.

○ **USING CHANNEL 16**

### **DISTRESS CALL PROCEDURE**

1. "MAYDAY MAYDAY MAYDAY."
2. "THIS IS ....." (name of vessel)
3. Your call sign or other indication of the vessel.
4. "LOCATED AT ....." (your position)
5. The nature of the distress and assistance required.
6. Any other information which might facilitate the rescue.

---

## RECOMMENDATION

---

**CLEAN THE TRANSCEIVER THOROUGHLY WITH FRESH WATER** after exposure to salt water.

Otherwise, the transceiver's keys, switches and controllers may become inoperable due to salt crystallization.



---

## FOREWORD

---

Thank you for purchasing this Icom product. The IC-M2A VHF MARINE TRANSCEIVER is designed and built with Icom's superior technology and craftsmanship. With proper care this product should provide you with years of trouble-free operation.

---

## IMPORTANT

---

**READ ALL INSTRUCTIONS** carefully and completely before using the transceiver.

**SAVE THIS INSTRUCTION MANUAL**—This instruction manual contains important operating instructions for the IC-M2A.

---

## EXPLICIT DEFINITIONS

---

WORD	DEFINITION
<b>⚠ WARNING</b>	Personal injury, fire hazard or electric shock may occur.
<b>CAUTION</b>	Equipment damage may occur.
<b>NOTE</b>	If disregarded, inconvenience only. No risk of personal injury, fire or electric shock.

---

## FEATURES

---

### **Waterproof construction**

Built tough to withstand the punishing marine environment, the IC-M2A meets JIS waterproof specification grade 7 while using BP-223 or BP-224.

### **Dual watch and tri-watch functions**

Convenient functions which allow you to monitor the distress channel (Ch 16) while receiving a channel of your choice—dual watch; or monitor the distress channel and another channel while receiving a channel of your choice—tri-watch.

### **Large, easy-to-read LCD**

With dimensions of 24(H) × 35(W) mm, the IC-M2A's function display is easy to read and shows operating conditions at a glance. Backlighting and contrast can be adjusted to suit your preferences.

### **Simple operation**

Ergonomic design with a minimum number of switches and controls provides simple intuitive operation.

---

## CAUTIONS

---

**⚠ WARNING! NEVER** connect the transceiver to an AC outlet. This may pose a fire hazard or result in an electric shock.

**⚠ WARNING! NEVER** hold the transceiver so that the antenna is very close to, or touching exposed parts of the body, especially the face or eyes, while transmitting. The transceiver will perform best if the microphone is 5 to 10 cm (2 to 4 inches) away from the lips and the transceiver is vertical.

**NEVER** connect the transceiver to a power source other than the BP-223 or BP-224. Such a connection will ruin the transceiver.

**AVOID** using or placing the transceiver in direct sunlight or in areas with temperatures below  $-20^{\circ}\text{C}$  ( $-4^{\circ}\text{F}$ ) or above  $+60^{\circ}\text{C}$  ( $+140^{\circ}\text{F}$ ).

**KEEP** the transceiver out of the reach of children.

**KEEP** the transceiver at least 0.9 meter (3.0 ft) away from your vessel's magnetic navigation compass.

**BE CAREFUL!** The transceiver's right-side panel will become hot when operating continuously for long periods.

**BE CAREFUL!** The IC-M2A employs waterproof construction, which corresponds to JIS waterproof specification, grade 7 (1 m; 3 ft depth for 30 min.). However, once the transceiver has been dropped, waterproofing cannot be guaranteed due to the fact that the transceiver may be cracked, or the waterproof seal damaged, etc.

**MAKE SURE** the flexible antenna and battery pack are securely attached to the transceiver, and that the antenna and battery pack are dry before attachment. Exposing the inside of the transceiver to water will result in serious damage to the transceiver.

*For U.S.A. only*

**CAUTION:** Changes or modifications to this device, not expressly approved by Icom Inc., could void your authority to operate this device under FCC regulations.

Icom, Icom Inc. and  are registered trademarks of Icom Incorporated (Japan) in the United States, United Kingdom, Germany, France, Spain, Russia and/or other countries.

---

# TABLE OF CONTENTS

---

SAFETY TRAINING INFORMATION .....	i	■ Operation .....	10
IN CASE OF EMERGENCY .....	ii	<b>5 SCAN OPERATION .....</b>	<b>11–12</b>
RECOMMENDATION .....	ii	■ Scan types .....	11
FOREWORD .....	iii	■ Setting tag channels .....	12
IMPORTANT .....	iii	■ Starting a scan .....	12
EXPLICIT DEFINITIONS .....	iii	<b>6 SET MODE .....</b>	<b>13–16</b>
FEATURES .....	iii	■ SET mode programming .....	13
CAUTIONS .....	iv	■ SET mode items .....	13
TABLE OF CONTENTS .....	v	<b>7 BATTERY CHARGING .....</b>	<b>17–19</b>
<b>1 OPERATING RULES .....</b>	<b>1</b>	■ Battery charging .....	17
<b>2 PANEL DESCRIPTION .....</b>	<b>2–5</b>	■ Battery cautions .....	17
■ Front, top and side panels.....	2	■ Installing batteries in the battery case .....	18
■ Function display .....	4	■ Optional battery chargers .....	19
<b>3 BASIC OPERATION .....</b>	<b>6–9</b>	<b>8 SUPPLIED ACCESSORIES AND ATTACHMENTS</b>	<b>20–22</b>
■ Channel selection .....	6	<b>9 TROUBLESHOOTING .....</b>	<b>23</b>
■ Lock function .....	7	<b>10 CHANNEL LIST .....</b>	<b>24</b>
■ Adjusting the squelch level .....	7	<b>11 SPECIFICATIONS AND OPTIONS .....</b>	<b>25</b>
■ Receiving and transmitting .....	8	■ Specifications .....	25
■ Call channel programming .....	9	■ Options .....	25
■ Automatic backlighting .....	9		
<b>4 DUALWATCH/TRI-WATCH .....</b>	<b>10</b>		
■ Description .....	10		

## ◇ Priorities

- Read all rules and regulations pertaining to priorities and keep an up-to-date copy handy. Safety and distress calls take priority over all others.
- You must monitor Channel 16 when you are not operating on another channel.
- False or fraudulent distress calls are prohibited under law.

## ◇ Privacy

- Information overheard but not intended for you cannot lawfully be used in any way.
- Indecent or profane language is prohibited.

## ◇ Radio licenses

### (1) SHIP STATION LICENSE

When your craft is equipped with a VHF FM transceiver, you must have a current radio station license before using the transceiver. It is unlawful to operate a ship station which is not licensed.

Inquire through your dealer or the appropriate government agency for a Ship-Radiotelephone license. This license includes the call sign which is your craft's identification for radio purposes.

### (2) OPERATOR'S LICENSE

A restricted Radiotelephone Operator Permit is the license most often held by small vessel radio operators when a radio is not required for safety purposes.

The Restricted Radiotelephone Operator Permit must be posted near the transceiver or be kept with the operator. Only a licensed radio operator may operate a transceiver.

However, non-licensed individuals may talk over a transceiver if a licensed operator starts, supervises, ends the call and makes the necessary log entries.

A current copy of the applicable government rules and regulations is only required to be on hand for vessels in which a radio telephone is compulsory. However, even if you are not required to have these on hand it is your responsibility to be thoroughly acquainted with all pertinent rules and regulations.

**NOTE:** Even though the IC-M2A is capable of operation on VHF marine channels 3, 21, 23, 61, 64, 81, 82 and 83, according to FCC regulations these simplex channels cannot be lawfully used by the general public in USA waters.

## ■ Front, top and side panels

### 1 CHANNEL/WEATHER CHANNEL SWITCH [CH/WX•U/I/C]

- Selects and toggles the regular channels and weather channel when pushed. (pgs. 6, 7)
- Selects one of 3 regular channels in sequence when pushed for 1 sec. (p. 6)
  - International, U.S.A. and Canadian channels are available.

### 2 CHANNEL UP/DOWN SWITCHES [▲]/[▼]

- Select an operating channel.
- Selects the SET mode condition of the item. (p. 13)
- Set the squelch level in the squelch set mode. (p. 7)

### 3 CHANNEL 16 SWITCH [16•9]

- Selects Channel 16 when pushed. (p. 6)
- Selects the call channel when pushed for 1 sec.
- Enters call Channel write mode when the call channel is selected and this switch is pushed for 3 sec. (p. 9)

### 4 SCAN/TAG SWITCH [SCN•TAG] (p. 12)

- Starts and stops normal or priority scan.
- Sets and clears the displayed channel as a tag (scanned) channel when pushed for 1 sec.

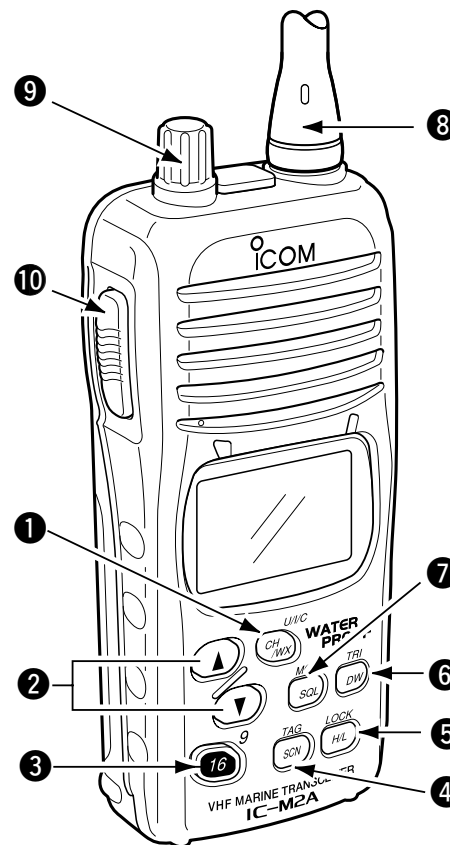

### 5 TRANSMIT POWER/LOCK SWITCH [H/L•LOCK]

- Selects high, middle or low power when pushed. (p. 8)
- Toggles the lock function ON/OFF when pushed for 1 sec. (p. 7)

### 6 DUALWATCH/TRI-WATCH SWITCH [DW•TRI] (p. 10)

- Starts dualwatch when pushed momentarily.
- Starts tri-watch when pushed for 1 sec.
- Stops dualwatch/tri-watch when either is activated.

### 7 SQUELCH SWITCH [SQL•MONI] (p. 7)

- Push this switch, then set the squelch level with [▲]/[▼].
- Manually opens the squelch for channel monitoring when pushed for 1 sec.

### 8 ANTENNA (p. 20)

Connects the supplied antenna.

### 9 VOLUME CONTROL [OFF/VOL]

Turns power ON and adjusts the audio level.

### 10 PTT SWITCH [PTT]

Push and hold to transmit; release to receive.



## ◇ BATTERY CASE RELEASE SCREW

*To remove the battery case:*

Turn the screw counterclockwise, then pull the battery pack in the direction of the arrow as shown below.

*To attach the battery case:*

Insert the battery case in the IC-M2A completely, then turn the screw clockwise.

**NOTE:** When removing or attaching the battery case, use a coin or flat-head screwdriver to loosen or tighten the bottom screw.

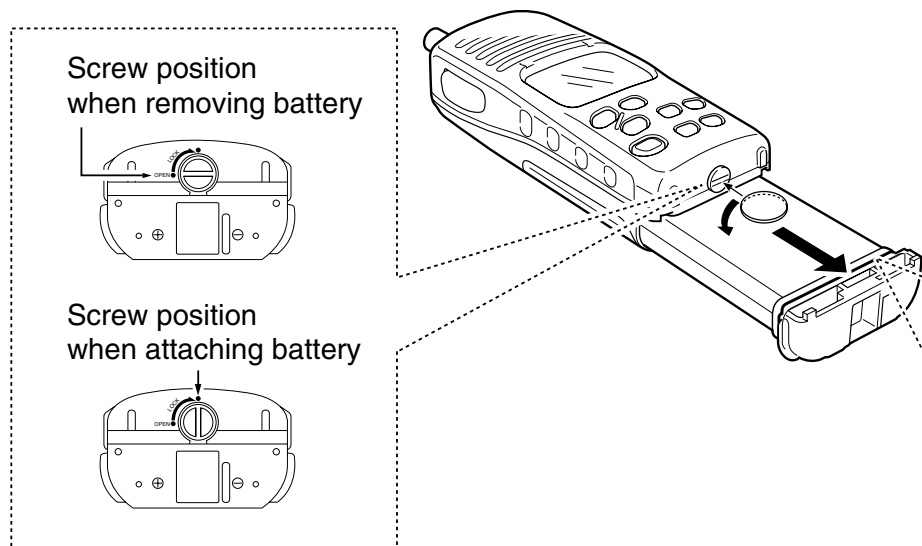

## CAUTION!:

When attaching or releasing a battery pack, make sure the rubber seal is set in the groove of the battery pack/case correctly. If the seal is not neatly in the groove it may be damaged when attaching the battery pack/case. If the seal is damaged, waterproofing is not guaranteed.

## NOTE:

When attaching a battery pack/case, make sure dust etc. does not adhere to the rubber seal. If dust etc. is on the seal when attaching a battery pack/case, the water resistant may be reduced.

Make sure both the rubber seal (purple) is set to the groove correctly and dust etc. does not adhere to it.

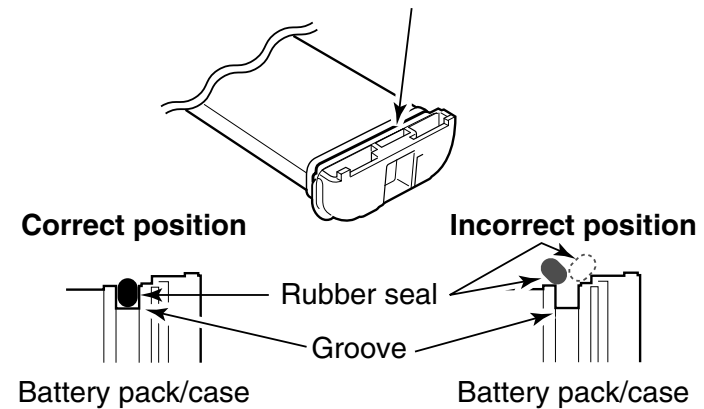

## 2 PANEL DESCRIPTION

### ■ Function display

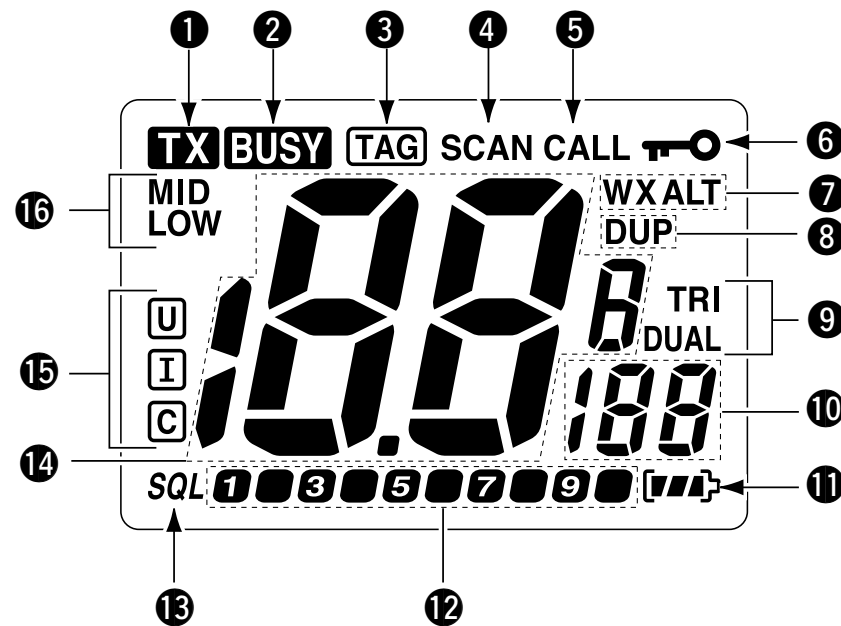

**1 TRANSMIT INDICATOR** (p. 8)

Appears while transmitting.

**2 BUSY INDICATOR** (p. 8)

Appears when receiving a signal or when the squelch opens.

**3 TAG CHANNEL INDICATOR** (p. 12)

Appears when a tag channel is selected.

**4 SCAN INDICATOR** (p. 12)

Blinks while scanning.

**5 CALL CHANNEL INDICATOR** (p. 6)

Appears when the call channel is selected.

**6 LOCK INDICATOR** (p. 7)

Appears while the lock function is activated.

**7 WEATHER CHANNEL/WEATHER ALERT INDICATORS**

- “WX” appears when the weather channel group is selected. (p. 7)
- “ALT” appears while the weather alert function is activated; blinks when on alert tone is received.

**8 DUPLEX INDICATOR**

Appears when a duplex channel is selected.

**9 DUALWATCH/TRI-WATCH INDICATORS** (p. 10)





“DUAL” appears during dualwatch; “TRI” appears during tri-watch.

**10 SUB CHANNEL READOUT**

- Indicates Channel 16 during priority scan.
- Indicates Channel 16 during dualwatch or tri-watch. (p. 10)
- Indicates the SET mode item while in SET mode

**11 BATTERY INDICATOR**

Indicates remaining battery power.

Indication				
Battery level	Full	Middle	Charging required	No battery

**12 SQUELCH LEVEL INDICATOR** (p. 7)

Shows squelch level when set.

This indicator can be also used as an S/RF meter when the S/RF meter indicator setting is ON. (p. 16)

**13 SQUELCH LEVEL ADJUSTING INDICATOR** (p. 7)

Appears while adjusting the squelch level.

**14 CHANNEL NUMBER READOUT**

- Indicates the selected operating channel number.
- In SET mode, indicates the selected condition.

**15 CHANNEL GROUP INDICATOR** (p. 6)

“U” appears when U.S.A.; “I” appears when International; “C” appears when the Canadian channel group is selected.

**16 TRANSMIT POWER INDICATOR**

- “LOW” appears when low power is selected. (p. 8)
- “LOW” blinks when switching forced low power mode because of a high temperature error or low voltage.
- “MID” appears when middle power is selected. (p. 8)
- No indicator appears when high power is selected.

## Channel selection

### ◇ Channel 16

Channel 16 is the distress channel. It is used for establishing initial contact with another station and for emergency communications. Channel 16 is monitored during dualwatch or tri-watch. While standing by you are required to monitor Channel 16.



### ◇ Channel 9 (Call channel)

Channel 9 is the leisure-use call channel. Each regular channel group has a separate call channel. The call channel is monitored during tri-watch. The call channels can be programmed (p. 9) and are used to store your most often-used channels in each channel group for quick recall.

• Push [16•9] for 1 sec. to select the call channel for the selected channel group.

- "CALL" and call channel number appear.
- Each channel group can have its own call channel when programmed.

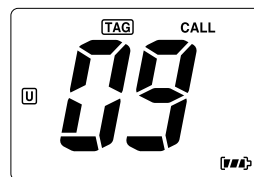

### ◇ U.S.A., International and Canadian channels

There are 57 U.S.A., 57 International and 61 Canadian channels. These channel groups may be specified for the operating area.

- ① Push [CH/WX] to select a regular channel.
  - If a weather channel appears, push [CH/WX] again.
- ② Push [▲]/[▼] switches to select a channel.
  - "DUP" appears for duplex channels.
- ③ To change the channel group, push [CH/WX•U/I/C] for 1 sec.
  - U.S.A., International and Canadian channels can be selected in sequence.

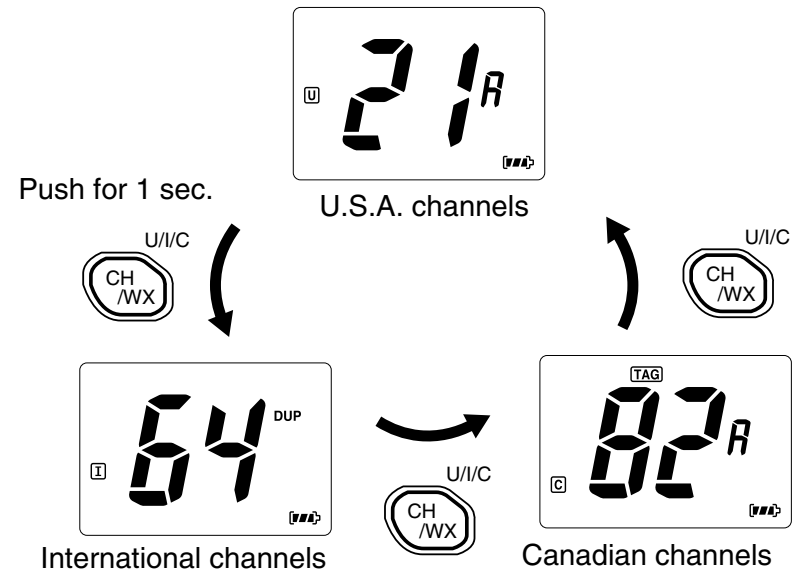

### ◇ Weather channels

There are 10 weather channels. These are used for monitoring weather channels from the NOAA (National Oceanographic and Atmospheric Administration) broadcasts.

The IC-M2A can detect a weather alert tone on the selected weather channel while scanning. See the “SET mode items” on p. 13.

- ① Push [CH/WX] to select a weather channel group.
- ② Push [▲]/[▼] to select a weather channel.
- ③ Push [CH/WX] to return to the condition before selecting weather channel group.

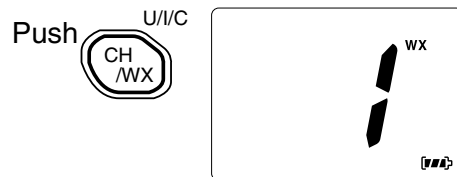

### ■ Lock function

This function electronically locks all keys, except [PTT], [SQL•MONI] and [H/L•LOCK] to prevent accidental channel changes and function access.

- Push [H/L•LOCK] for 1 sec. to turn the lock function ON and OFF.
  - Only [PTT], [H/L•LOCK] and [SQL•MONI] are functional.

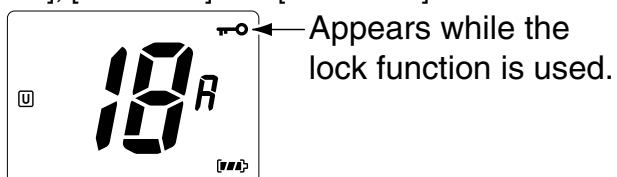

### ■ Adjusting the squelch level

The IC-M2A has a squelch even though there is no control knob for it. In order to receive signals properly, as well as for scan to function, the squelch must be adjusted to a suitable level.

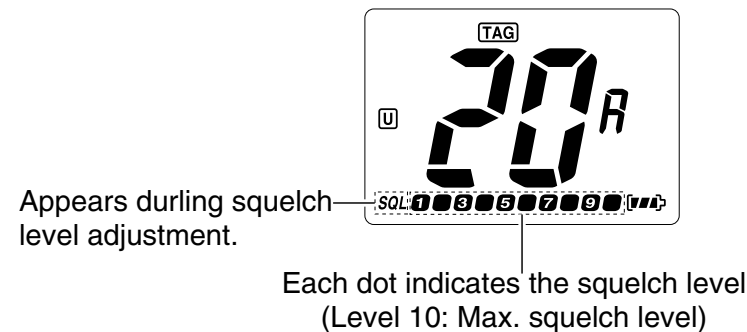

- ① Push [SQL•MONI], then adjust the squelch level with [▲]/[▼].
  - “SQL” indicator and squelch level indicator appear.
  - There are 11 squelch levels to choose from: 0 is completely open; 10 is the maximum squelch level.
  - When no keys are pushed for 5 sec., the transceiver returns to normal condition.
- ② Push [SQL•MONI] again to return to normal condition.

## 3 BASIC OPERATION

### ■ Receiving and transmitting

**CAUTION:** Transmitting without an antenna may damage the transceiver.

- ① Rotate [OFF/VOL] clockwise to turn power ON.
  - Use the squelch function to mute any audio noise if necessary. Refer to the previous page for details.
- ② Push\* [SQL•MONI] for 1 sec., and rotate volume to set audio output level.
  - \*According to Monitor action selection in SET mode (p. 14).
- ③ Push [▲]/[▼] to select the desired channel.
  - When receiving a signal, “BUSY” appears and audio is emitted from the speaker.
  - (The S/R/F meter appears while S/R/F meter turned ON in SET mode.)
  - Further adjustment of [OFF/VOL] may be necessary at this point.
- ④ Push [H/L] to select the output power if necessary.
  - “LOW” appears when low power is selected; “MID” appears when middle power is selected; no indicator appears when high power is selected.
  - Choose low power to conserve battery power, choose high power for longer distance communications.
  - Some channels are for low power only.
- ⑤ Push and hold [PTT] to transmit, then speak into the microphone.
  - “TX” appears.
  - (The S/R/F meter appears while S/R/F meter is turned ON in SET mode.)
  - Channel 70 cannot be used for transmission (for GMDSS use).
- ⑥ Release [PTT] to receive.

**IMPORTANT:** To maximize the readability of your transmitted signal, pause a few sec. after pushing [PTT], hold the microphone 5 to 10 cm (2 to 4 inches) from your mouth and speak at a normal voice level.

**NOTE:** The transceiver has a power save function to conserve the battery power and cannot be turned OFF. The power save function activates automatically when no signal is received for 5 sec.

**For U.S.A version:** To prevent accidental prolonged transmission, etc., the IC-M2A has a time-out timer function. This timer cuts a transmission OFF after 5 min. of continuous transmission.

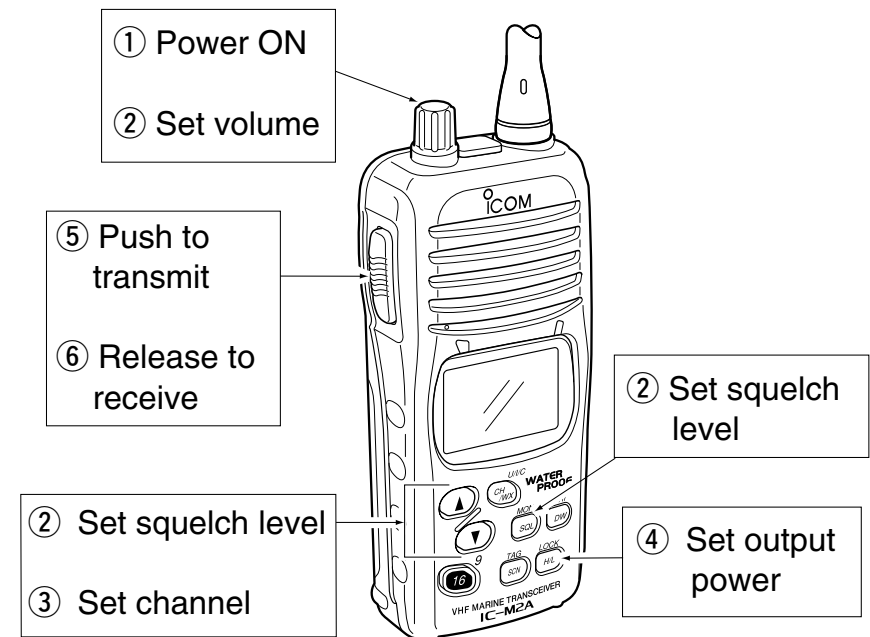

## ■ Call channel programming

The call channel switch is used to select Channel 9 by default, however, you can program your most often-used channels in each channel group for quick recall.

- ① Push [CH/WX•U/I/C] for 1 sec. to select the desired channel group (USA, INT, CAN) to be programmed.



- ② Push [16•9] for 1 sec. to select the call channel of the selected channel group.  
- "CALL" and call channel number appear.



- ③ Push [16•9] again for 3 sec. (until long beep changes to 2 short beeps) to enter call channel programming condition.  
- Call channel number and channel group to be programmed flash.

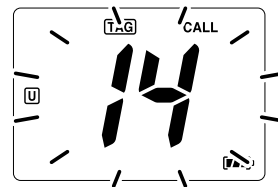

- ④ Push [▲]/[▼] to select the desired channel.

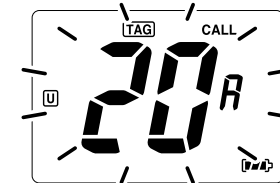

- ⑤ Push [16•9] to program the displayed channel as the call channel.  
- The call channel number and channel group stop flashing.

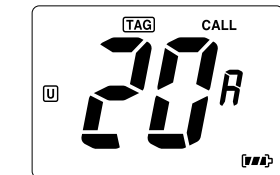

## ■ Automatic backlighting

This function is convenient for nighttime operation. The automatic backlighting can be deactivated in SET mode. (p. 15)

- Push any key except for [PTT] to turn the backlighting ON.  
- The backlighting is automatically turned OFF after 5 sec. of inactivity.

## ■ Description

Dualwatch monitors Channel 16 while you are receiving another channel; tri-watch monitors Channel 16 and the call channel while receiving another channel.

### DUALWATCH/TRI-WATCH SIMULATION

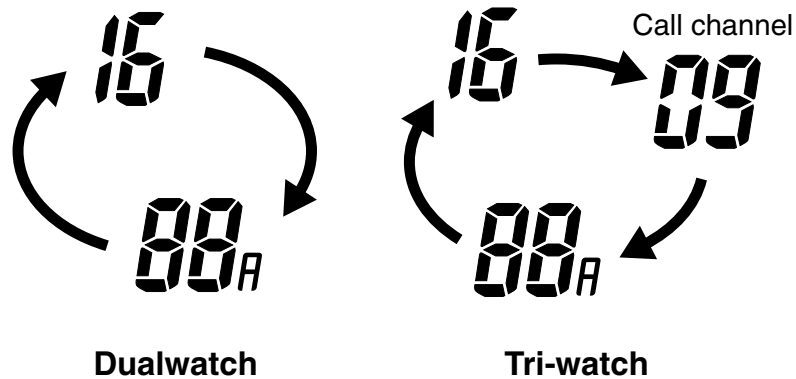

- If a signal is received on Channel 16, dualwatch/tri-watch pauses on Channel 16 until the signal disappears.
- If a signal is received on the call channel during tri-watch, tri-watch becomes dualwatch until the signal disappears.
- To transmit on the selected channel during dualwatch/tri-watch, push and hold [PTT].

## ■ Operation

- ① Select the desired operating channel.
- ② Push [DW•TRI] momentarily to start dualwatch; push [DW•TRI] for 1 sec. to start tri-watch.
  - “DUAL” flashes during dualwatch; “TRI” flashes during tri-watch.
  - Beep tones sound when a signal is received on Channel 16.
  - Tri-watch becomes dualwatch when receiving a signal on the call channel.
- ③ To cancel dualwatch/tri-watch, push [DW•TRI] again.

**[Example]:** Operating tri-watch on INT Channel 07.

Push for 1 sec.

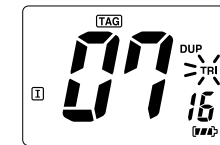

Tri-watch starts.

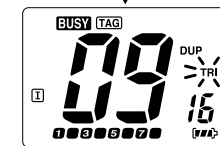

Signal is received on call channel.



Signal received on Channel 16 takes priority.

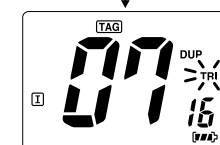

Tri-watch resumes after the signal disappears.



## ■ Scan types

Scanning is an efficient way to locate signals quickly over a wide frequency range. The transceiver has a priority scan and a normal scan.

In addition, weather alert functions are available for standby convenience. (p. 13)

Set the tag channels (channels to be scanned) before scanning. Clear the tag channels which inconveniently stop scanning, such as those used for digital communications.

**NOTE:** Choose priority or normal scan in SET mode. (p. 14)

### PRIORITY SCAN

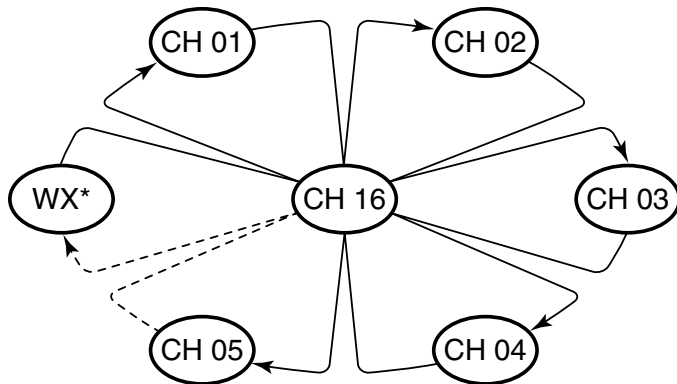

\* Previously selected weather channel when weather alert function is ON.

Priority scan searches through all tag channels in sequence while monitoring Channel 16. When a signal is detected on Channel 16, scan pauses until the signal disappears; when a signal is detected on a channel other than Channel 16, scan becomes dualwatch until the signal disappears.

### NORMAL SCAN

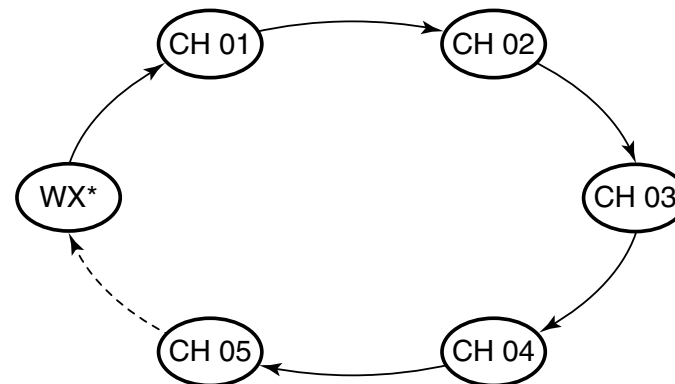

\* Previously selected weather channel when weather alert function is ON.

Normal scan, like priority scan, searches through all tag channels in sequence. However, unlike priority scan, Channel 16 is not checked unless Channel 16 is set as a tag channel.

## 5 SCAN OPERATION

### ■ Setting tag channels

For more efficient scanning, add desired channels as tag channels or clear tag channels for unwanted channels. Channels set as non-tag channels will be skipped during scanning. Tag channels can be assigned to each channel group (USA, INT, CAN) independently.

- ① Select the desired channel group (USA, INT, CAN) by pushing [CH/WX•U/I/C] for 1 sec., if desired.
- ② Select the desired channel to set as a tag channel.
- ③ Push [SCN•TAG] for 1 sec. to set the displayed channel as a tag channel.
  - “TAG” appears in the function display.
- ④ To cancel the tag channel setting, push [SCN•TAG] for 1 sec.
  - “TAG” disappears.

- **Clearing all tag channels in the selected channel group**  
While pushing [SCN•TAG], turn the power ON to clear all tag channels in the channel group.

### ■ Starting a scan

Set scan type, weather alert function and scan resume timer in advance using SET mode. (pgs. 13, 14)

- ① Select the desired channel group (USA, INT, CAN) by pushing [CH/WX•U/I/C] for 1 sec., if desired.
  - When the weather alert function is in use, select the desired weather channel with [CH/WX] and the [▲]/[▼].
- ② Push [SCN•TAG] to start priority or normal scan.
  - “SCAN” blinks in the function display.
  - “16” appears during priority scan.
  - When a signal is detected, scan pauses until the signal disappears or resumes after pausing 5 sec. according to SET mode setting. (Channel 16 is still monitored during priority scan.)
  - Push [▲]/[▼] to check tag channels, to change the scanning direction or resume the scan manually.
- ③ To stop the scan, push [SCN•TAG].
  - “SCAN” disappears.
  - Pushing [PTT], [16•9], [CH/WX] or [DW•TRI] also stops the scan.

**[Example]:** Starting a normal scan.

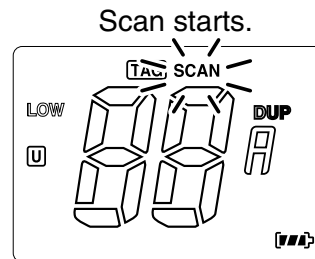
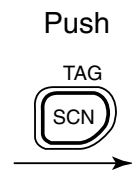
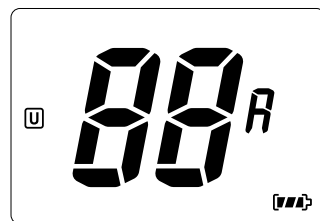

Scan pauses when receiving a signal and audio is emitted.

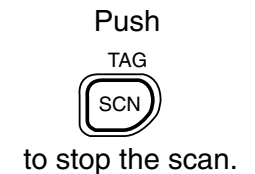
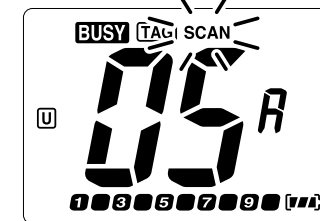

## ■ SET mode programming

SET mode is used to change the conditions of 12 transceiver functions: beep tone, weather alert, scan type, scan resume timer, auto scan, monitor switch, automatic backlighting, LCD contrast, auto power save, self check, battery voltage and S/RF meter functions.

- ① Turn power OFF.
- ② While pushing [SQL•MONI], turn power ON and continue pushing [SQL•MONI] until “bP” appears.
- ③ Release [SQL•MONI].
- ④ Push [▲]/[▼] to select the desired condition of the item.
- ⑤ Push [SQL•MONI] to select the desired item, if necessary.
- ⑥ To exit SET mode, turn the power OFF, then ON again, or push [16•9].

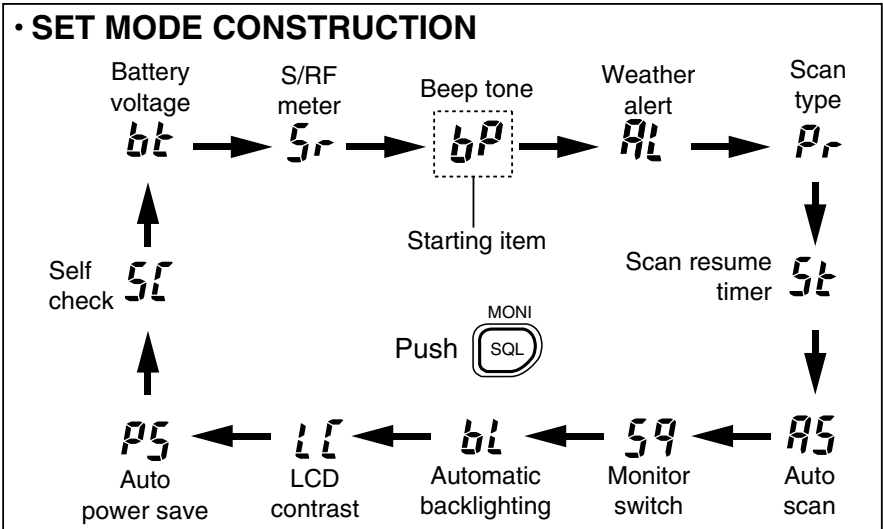

## ■ SET mode items

### ◇ Beep tone “bP”

You can select silent operation by turning beep tones OFF or you can have confirmation beeps sound at the push of a switch by turning beep tones ON.

- AUTO (At): Beep tone is linked with volume tone.
- 1–10: Beep tone scale is set from 1–10 scale (Max. is 10).



Beep tone AUTO (default)

### ◇ Weather alert function “AL”

NOAA broadcast stations transmit weather alert tones before important weather announcements. When the weather alert function is turned ON, the transceiver detects the alert, the “ALT” indicator blinks and sounds a beep tone until the transceiver is operated. The previously selected (used) weather channel is checked periodically during standby or while scanning.

- “ALT” appears when the function is set ON.

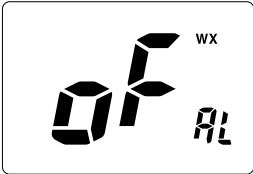

Weather alert function OFF (default)



Weather alert function ON

## 6 SET MODE

### ◇ Priority scan function “Pr”

The transceiver has 2 scan types. Normal scan and priority scan. Normal scan searches all tag channels in the selected channel group. Priority scan searches all tag channels in sequence while monitoring Channel 16.

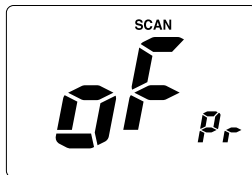

Normal scan (default)

### ◇ Scan resume timer “St”

The scan resume timer can be selected as a pause (OFF) or timer scan (ON). When OFF is selected, the scan pauses until a received signal disappears. When ON is selected, the scan pauses for 5 sec. after receiving a signal and then resumes even if the signal is still being received.

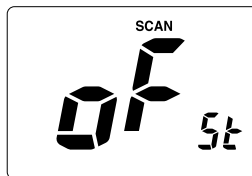

Scan timer OFF (default)

### ◇ Auto scan function “AS”

While in standby, this function automatically starts the desired scan (normal or priority scan) 30 sec. after operation.

- Scan indicator blinks while scanning.

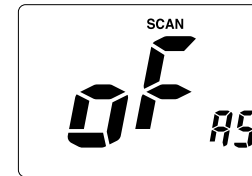

Auto scan OFF (default)

### ◇ Monitor action selection “Sq”

The monitor function cuts off the squelch function temporarily. This selection contains PUSH or HOLD settings as shown below.

- PUSH (Pu): After pushing the [SQL•MONI] for 1 sec., the squelch function is cut off until [SQL•MONI] is released. (default)
- HOLD (Ho): After pushing the [SQL•MONI] for 1 sec., the squelch function is cut off continuously until another key is pushed.

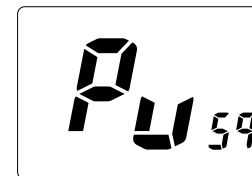

Monitor switch PUSH (default)

◇ **Automatic backlighting** “bL”

This function is convenient for nighttime operation. The automatic backlighting turns the backlighting ON when pushing any key except for [PTT].

- The backlighting is automatically turned OFF after 5 sec. of inactivity.



Automatic backlighting ON (default)

◇ **LCD contrast selection** “LC”

The contrast of the LCD can be adjusted from 4 levels.

- 1 (low contrast) – 4 (high contrast); 3 (default)

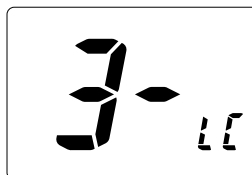

LCD contrast (default)

◇ **Auto power save function** “PS”

The power save function reduces current drain by deactivating the receiver circuit for preset intervals.



Auto power save ON (default)

◇ **Self check function** “SC”

The self check function checks transceiver conditions by itself, and informs you in case a problem is found. The following items are checked after the power is turned ON, then it switches to operation mode.

- Temperature (Outside of  $-20^{\circ}\text{C}$  to  $+60^{\circ}\text{C}$ ;  $-4^{\circ}\text{F}$  to  $+140^{\circ}\text{F}$ )
- Connected battery voltage
- Water intrusion



Self check OFF (default)

When error messages as shown below are displayed, see trouble shooting for advice (p. 23).

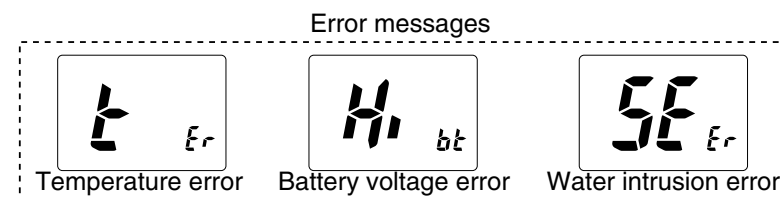

## 6 SET MODE

### ◇ Battery voltage indicator "bt"

This function contains display or non-display settings of the voltage of the connected battery pack when the power is ON.

- The voltage of the connected battery pack is displayed for 2 sec. after power is turned ON.

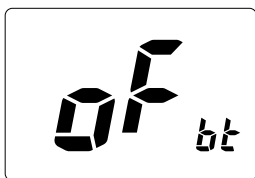

Battery voltage OFF (default)

### ◇ S-meter/RF meter indicator "Sr"

This function contains display or non-display setting of the S-meter/RF meter.

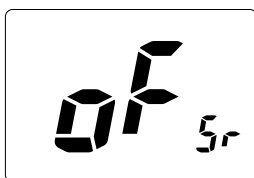

S-meter/RF meter OFF (default)

### SET MODE LIST

Function	Indication	Switch
Beep tone	"bP"	OFF / Auto* / 1–10
Weather alert function	"AL"	OFF* / ON
Scan type selection	"Pr"	OFF* / ON
Scan resume timer	"St"	OFF* / ON
Auto scan function	"AS"	OFF* / ON
Monitor switch selection	"Sq"	Push* / Hold
Automatic backlighting	"bL"	ON* / OFF
LCD contrast selection	"LC"	3* / 1–4
Auto power save function	"PS"	ON* / OFF
Self check function	"SC"	OFF* / ON
Battery voltage indicator	"bt"	OFF* / ON
S-meter/RF meter indicator	"Sr"	OFF* / ON

\*default setting

## ■ Battery charging

Prior to using the transceiver for the first time, the Ni-Cd batteries must be fully charged for optimum life and operation.

**CAUTION:** To avoid damage to the transceiver, turn it OFF while charging.

- Recommended temperature range for charging:  
+50°F to +104°F (+10°C to +40°C)
- Use the supplied AC adapter (BC-147A/E or BM-95V) only. **NEVER** use other adapters.

**NEVER** connect DC power to the battery case when installing alkaline batteries. Such a connection will damage the transceiver.

## ■ Battery cautions

**NEVER** incinerate used Ni-Cd batteries. Internal battery gas may cause an explosion.

**NEVER** immerse batteries in water. If the battery case becomes wet, be sure to wipe it dry **BEFORE** attaching it to the transceiver.

**NEVER** short terminals of the battery case. Also, current may flow into nearby metal objects so be careful when placing battery cases in handbags, etc.

If your Ni-Cd batteries seem to have no capacity even after being charged, completely discharge them by leaving the power ON overnight. Then, fully charge the Ni-Cd batteries again. If the batteries still do not retain a charge (or very little), new batteries must be purchased.

### ◇ Recycling information (*U.S.A. only*)



The product that you have purchased contains a rechargeable battery. The battery is recyclable. At the end of its life, under various state and local laws, it may be illegal to dispose of this battery into the municipal waste stream. Call 1-800-822-8837 for battery recycling options in your area or contact your dealer.

## 7 BATTERY CHARGING

### ◇ Charging connections

- ① Attach the BC-150 to a flat surface, such as desk or cabin, etc., if desired.
- ② Connect the AC adapter (BC-147A/E or BM-95V) as shown below.
- ③ Insert the battery pack with/without the transceiver into the charger.
  - The charge indicator lights green.
- ④ Charge the battery pack approx. 8 hours, depending on the remaining power condition.

**CAUTION: DO NOT** charge BP-224 more than 12 hours. Otherwise, BP-224 will be damaged. BP-224 must be charged for 8–12 hours only.

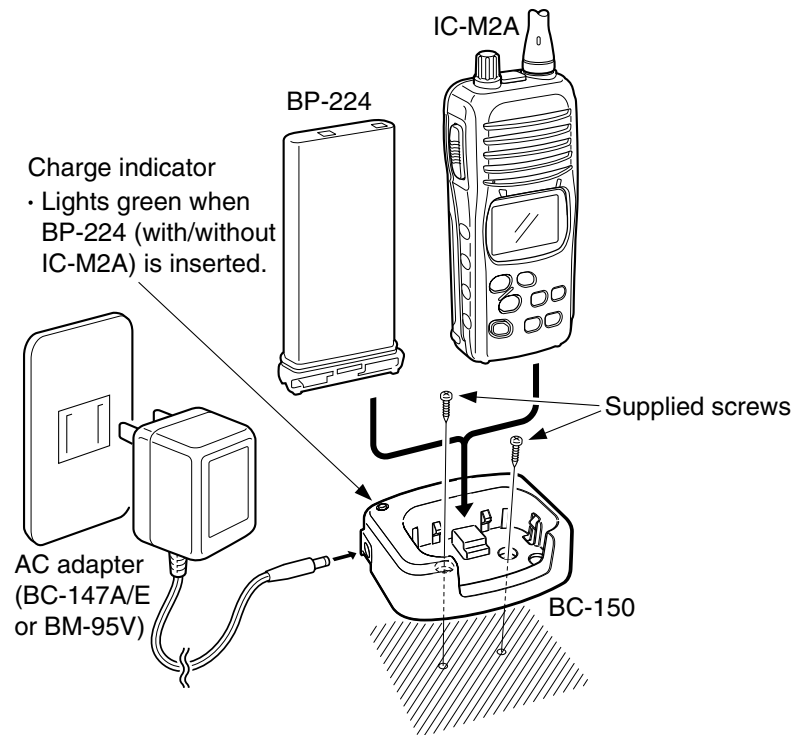

### ■ Installing batteries in the battery case (Not supplied with some versions)

When using a battery case attached to the transceiver, install 6 × AA(R6) size alkaline batteries as illustrated below.

- ① Remove the battery case from the transceiver.
- ② Install 6 × AA(R6) size alkaline batteries.
  - Be sure to observe the correct polarity.

#### CAUTION:

- When installing batteries, make sure they are all the same brand, type and capacity. Also, do not mix new and old batteries together.
- Keep battery contacts clean. It's a good idea to clean battery terminals once a week.

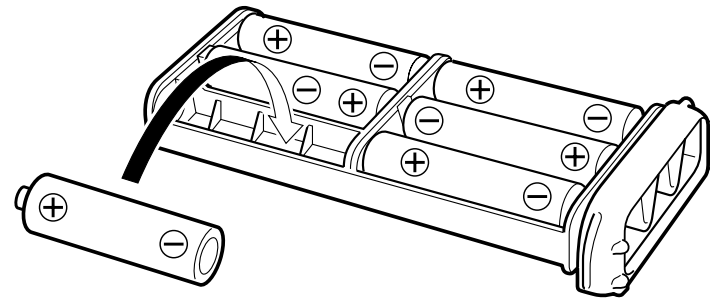



## ■ Optional battery chargers

### ◇ Rapid charging with the BC-119N+AD-103

The optional BC-119N provides rapid charging of battery packs. The following are additionally required.

- AD-103
- An AC adapter (may be supplied with BC-119N depending on version).

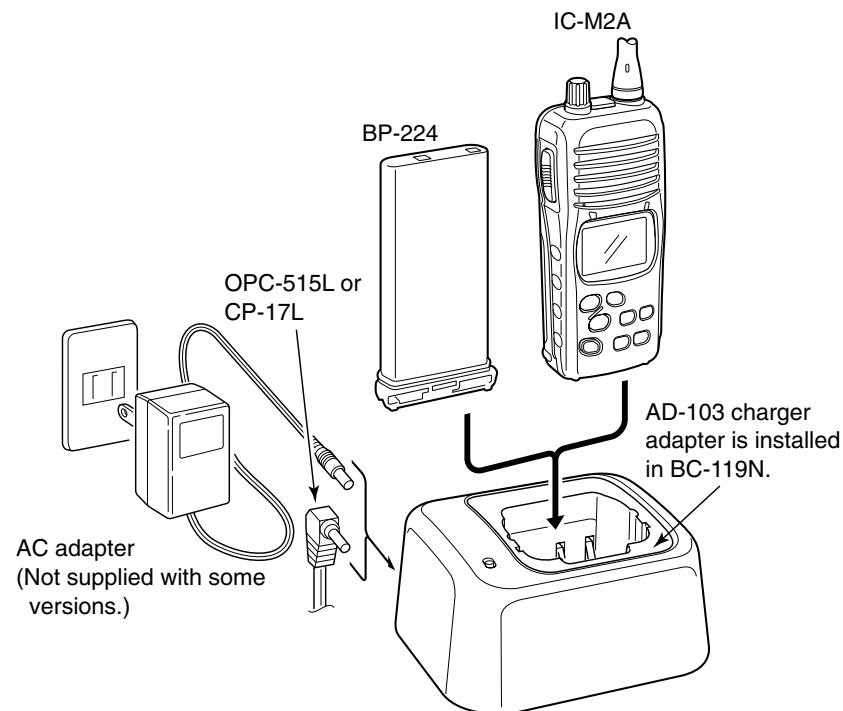

### ◇ Rapid charging with the BC-121N+AD-103

The optional BC-121N allows up to 6 battery packs to be charged simultaneously. The following are additionally required.

- Six AD-103.
- An AC adapter (BC-124) or the DC power cable (OPC-656).

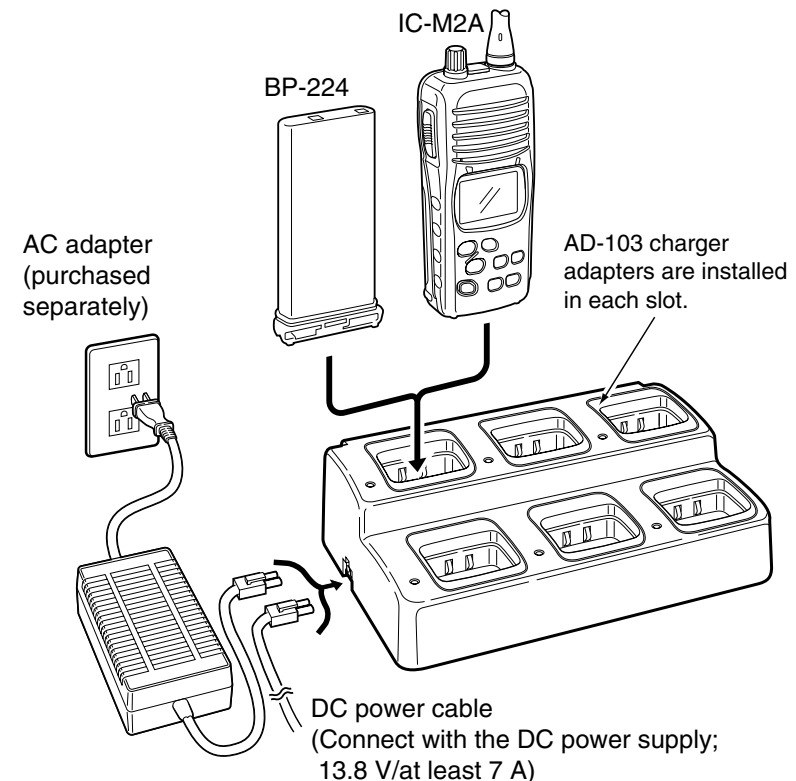

# 8

## SUPPLIED ACCESSORIES AND ATTACHMENTS

### ◇ Supplied accessories

The following accessories are supplied:

	Qty.
① Flexible antenna .....	.1
② Swivel belt clip .....	.1
③ Handstrap .....	.1
④ Battery case (BP-223)* <sup>1</sup> .....	.1
⑤ Ni-Cd battery pack (BP-224) .....	.1
⑥ AC adapter (BC-147A/E or BM-95V)* <sup>2</sup> .....	.1
⑦ Battery charger (BC-150) .....	.1
⑧ Screws for the BC-150 (M3.5 × 20) .....	.2

\*<sup>1</sup> Not supplied with some versions.

\*<sup>2</sup> Depending on version.

### ◇ Flexible antenna

Connect the supplied flexible antenna to the antenna connector.

**CAUTION:** Transmitting without an antenna may damage the transceiver.

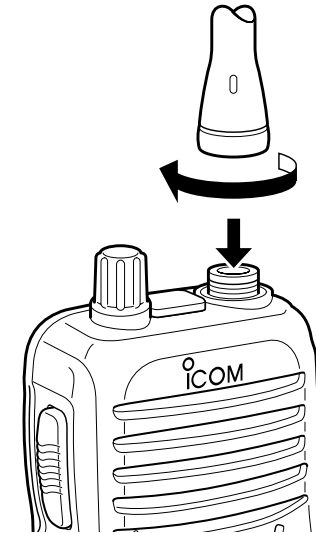

### ◇ Handstrap

Slide the handstrap through the loop on the side of the transceiver as illustrated at right. Facilitates carrying.

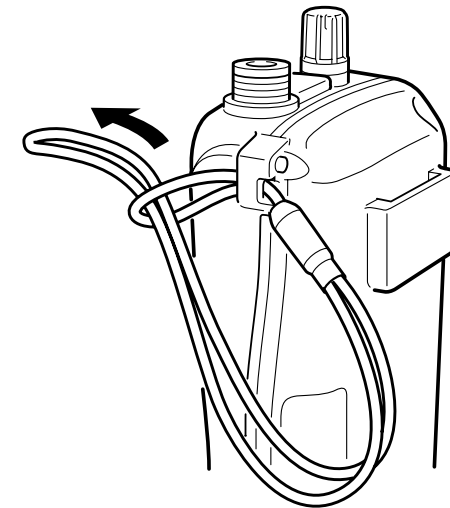

◆ Swivel belt clip

To attach:

① Slide the stopper into the plastic loop on the back of the transceiver.

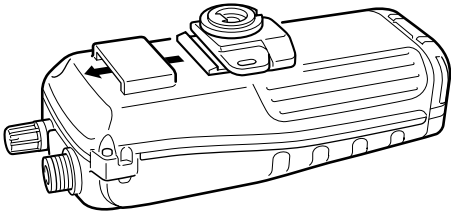

② Clip the belt clip to a part of your belt.

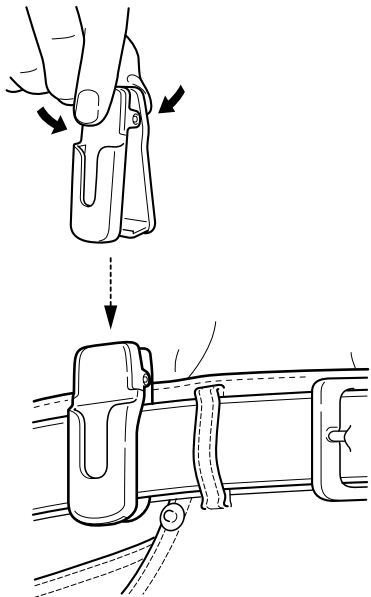

③ Insert the stopper to the back of the belt clip.

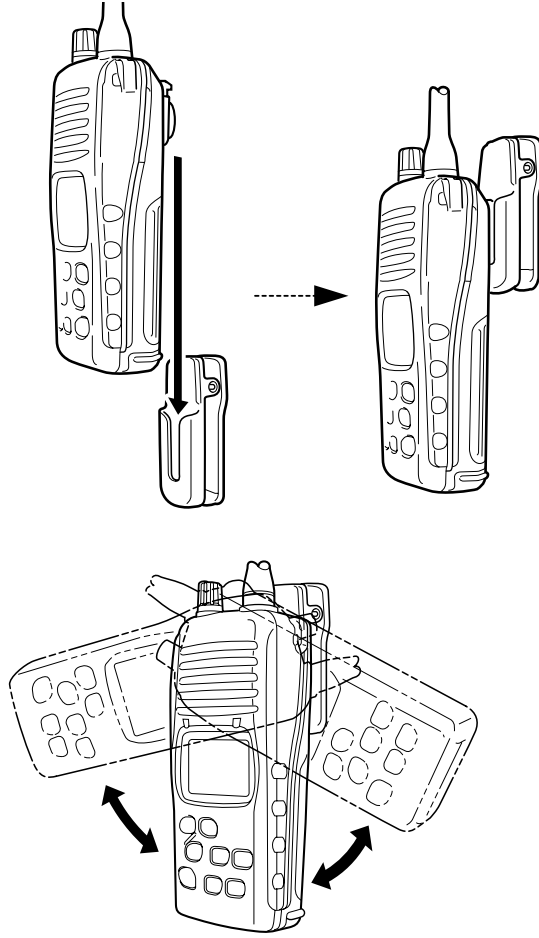

Once the transceiver is locked in place, it will swivel 360 degrees.

## 8 SUPPLIED ACCESSORIES AND ATTACHMENTS

To remove:

- ① Turn the transceiver upside down, and then lift to release the transceiver from the belt clip.

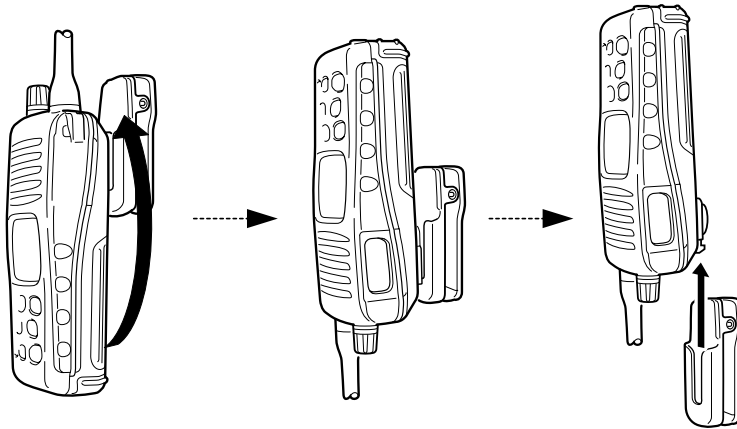

**⚠ CAUTION!**  
**HOLD THE TRANSCEIVER TIGHTLY, WHEN ATTACHING OR REMOVING THE TRANSCEIVER FROM THE BELT CLIP.**

If the transceiver is accidentally dropped and the swivel belt clip's stopper is scratched or damaged, the swivel belt clip may not work properly.

- ② Release the belt clip.

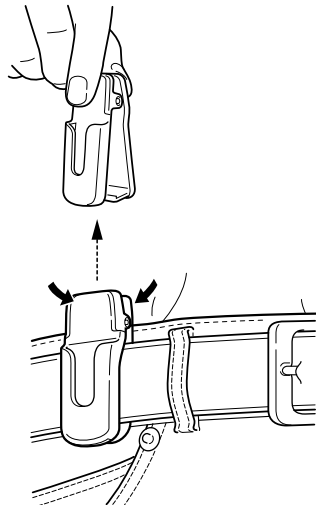

- ③ Push the top of the stopper towards the transceiver and out at the same time, then push it downwards and free of the plastic loop.

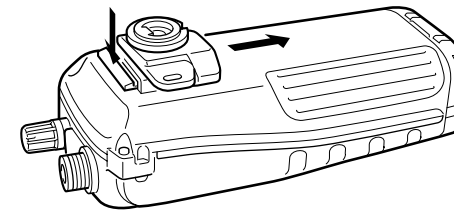

# TROUBLESHOOTING

PROBLEM	POSSIBLE CAUSE	SOLUTION.	REF.
No power comes ON.	<ul style="list-style-type: none"> <li>• The battery is exhausted.</li> <li>• Bad connection to the battery pack.</li> </ul>	<ul style="list-style-type: none"> <li>• Recharge the battery pack.</li> <li>• Check the connection to the transceiver.</li> </ul>	p. 17 p. 3
No sound comes from the speaker.	<ul style="list-style-type: none"> <li>• Squelch level is too deep.</li> <li>• Volume level is too low.</li> <li>• Speaker has been exposed to water.</li> </ul>	<ul style="list-style-type: none"> <li>• Set squelch to the threshold point.</li> <li>• Set [OFF/VOL] to a suitable level.</li> <li>• Drain water from the speaker.</li> </ul>	p. 7 p. 8 —
Transmitting is impossible, or high power cannot be selected.	<ul style="list-style-type: none"> <li>• Some channels are for low power or receive only.</li> <li>• The battery is exhausted.</li> <li>• The output power is set to low.</li> </ul>	<ul style="list-style-type: none"> <li>• Change channels.</li> <li>• Recharge the battery pack.</li> <li>• Push [H/L] to select high power.</li> </ul>	pgs. 2, 4  p. 17 p. 2
The display channel cannot be changed.	<ul style="list-style-type: none"> <li>• Lock function is activated.</li> </ul>	<ul style="list-style-type: none"> <li>• Push [H/L•LOCK] for 1 sec. to cancel the function.</li> </ul>	p. 2
Scan does not start.	<ul style="list-style-type: none"> <li>• “TAG” channels are not programmed.</li> </ul>	<ul style="list-style-type: none"> <li>• Set the desired channels as “TAG” channels.</li> </ul>	p. 12
No beeps sound.	<ul style="list-style-type: none"> <li>• Beep tones are turned OFF.</li> </ul>	<ul style="list-style-type: none"> <li>• Set the beep tones to AUTO or 1–10 in SET mode.</li> </ul>	p. 13
Self check error. (Temperature error)	<ul style="list-style-type: none"> <li>• Transceiver’s inside temperature is below <math>-20^{\circ}\text{C}</math> (<math>-4^{\circ}\text{F}</math>) or above <math>+60^{\circ}\text{C}</math> (<math>+120^{\circ}\text{F}</math>).</li> </ul>	<ul style="list-style-type: none"> <li>• Leave the transceiver at room temperature for a while. Turn the power ON to check if the internal temperature has returned to normal.</li> </ul>	—
Self check error. (Battery voltage error)	<ul style="list-style-type: none"> <li>• The connected battery pack’s voltage is more than 11 V.</li> </ul>	<ul style="list-style-type: none"> <li>• Verify the battery voltage is correct.</li> </ul>	—
Self check error. (Water intrusion error)	<ul style="list-style-type: none"> <li>• Water has entered the transceiver.</li> </ul>	<ul style="list-style-type: none"> <li>• Have the transceiver checked at your local distributor or dealer to see whether the transceiver works properly or not.</li> </ul>	—

# 10 CHANNEL LIST

Channel number			Frequency (MHz)	
USA	INT	CAN	Transmit	Receive
	01	01	156.050	160.650
01A			156.050	156.050
	02	02	156.100	160.700
	03	03	156.150	160.750
03A			156.150	156.150
	04		156.200	160.800
		04A	156.200	156.200
	05		156.250	160.850
05A		05A	156.250	156.250
06	06	06	156.300	156.300
	07		156.350	160.950
07A		07A	156.350	156.350
08	08	08	156.400	156.400
09	09	09	156.450	156.450
10	10	10	156.500	156.500
11	11	11	156.550	156.550
12	12	12	156.600	156.600
13*	13	13*	156.650	156.650
14	14	14	156.700	156.700
15*	15*	15*	156.750	156.750
16	16	16	156.800	156.800
17*	17	17*	156.850	156.850
	18		156.900	161.500
18A		18A	156.900	156.900
	19		156.950	161.550

Channel number			Frequency (MHz)	
USA	INT	CAN	Transmit	Receive
19A		19A	156.950	156.950
20	20	20*	157.000	161.600
20A			157.000	157.000
	21	21	157.050	161.650
21A		21A	157.050	157.050
	22		157.100	161.700
22A		22A	157.100	157.100
	23	23	157.150	161.750
23A			157.150	157.150
24	24	24	157.200	161.800
25	25	25	157.250	161.850
26	26	26	157.300	161.900
27	27	27	157.350	161.950
28	28	28	157.400	162.000
	60	60	156.025	160.625
	61		156.075	160.675
61A		61A	156.075	156.075
	62		156.125	160.725
		62A	156.125	156.125
	63		156.175	160.775
63A			156.175	156.175
	64	64	156.225	160.825
64A		64A	156.225	156.225
	65		156.275	160.875
65A	65A	65A	156.275	156.275

Channel number			Frequency (MHz)	
USA	INT	CAN	Transmit	Receive
	66		156.325	160.925
66A	66A	66A*	156.325	156.325
67*	67	67	156.375	156.375
68	68	68	156.425	156.425
69	69	69	156.475	156.475
70	70	70	Rx only	156.525
71	71	71	156.575	156.575
72	72	72	156.625	156.625
73	73	73	156.675	156.675
74	74	74	156.725	156.725
77*	77	77*	156.875	156.875
	78		156.925	161.525
78A		78A	156.925	156.925
	79		156.975	161.575
79A		79A	156.975	156.975
	80		157.025	161.625
80A		80A	157.025	157.025
	81		157.075	161.675
81A		81A	157.075	157.075
	82		157.125	161.725
82A		82A	157.125	157.125
	83	83	157.175	161.775
83A		83A	157.175	157.175
84	84	84	157.225	161.825
84A			157.225	157.225

Channel number			Frequency (MHz)	
USA	INT	CAN	Transmit	Receive
85	85	85	157.275	161.875
85A			157.275	157.275
86	86	86	157.325	161.925
86A			157.325	157.325
87	87	87	157.375	161.975
87A			157.375	157.375
88	88	88	157.425	162.025
88A			157.425	157.425
		21b	Rx only	161.650
		25b	Rx only	161.850
		28b	Rx only	162.000
		83b	Rx only	161.775
WX channel	Frequency (MHz)			
	Transmit	Receive		
1	RX only		162.550	
2	RX only		162.400	
3	RX only		162.475	
4	RX only		162.425	
5	RX only		162.450	
6	RX only		162.500	
7	RX only		162.525	
8	RX only		161.650	
9	RX only		161.775	
10	RX only		163.275	

\*Low power only.

**NOTE:** Simplex channels 3, 21, 23, 61, 64, 81, 82 and 83 **CANNOT** be lawfully used by the general public in USA waters.

## ■ Specifications

### • GENERAL

Frequency coverage	: Transmit 156.025–157.425 MHz
	Receive 156.050–163.275 MHz
Mode	: FM (16K0G3E)
Channel spacing	: 25 kHz
Current drain (at 7.5 V DC)	: TX High (5 W) 1.5 A typical.
	Max. audio 200 mA typical
	Power save 20 mA typical
Frequency stability	: ±10 ppm (–20°C to +60°C)
Useable temperature range	: –20°C to +60°C; –4°F to +140°F
Dimensions	: 61 (W) × 135(H) × 41(D) mm
(Projections not included)	: 2 <sup>13</sup> / <sub>32</sub> (W) × 5 <sup>5</sup> / <sub>16</sub> (H) × 1 <sup>5</sup> / <sub>8</sub> (D) inch
Weight (approx.; with BP-224)	: 360g (12.7 oz)

### • TRANSMITTER

Output power (at 7.5 V DC)	: 5 W (Hi), 3 W (Mid) and 1 W (Low)
Modulation system	: Variable reactance frequency modulation
Max. frequency deviation	: ±5 kHz
Audio harmonics distortion	: Less than 10 % (at 60 % mod.)
Spurious emissions	: Less than –65 dBc

### • RECEIVER

Receive system	: Double-conversion superheterodyne
Sensitivity (12 dB SINAD)	: 0.25 μV typical
Squelch sensitivity	: Less than 0.35 μV (at threshold)
Intermodulation rejection ratio	: 70 dB typical
Spurious response rejection ratio	: 70 dB typical
Adjacent channel selectivity	: 70 dB typical
Ham and noise ratio	: More than 40 dB
Audio output power	: 0.35 W typical at 10% distortion with an 8 Ω load

## ■ Options

### ◇ BATTERY CASE AND PACK

#### • BP-223 BATTERY CASE

Battery case for 6 × AA (R6) alkaline cells. The same as supplied with the transceiver depending on versions.

#### • BP-224 Ni-Cd BATTERY PACK

7.2 V/750 mAh Ni-Cd battery pack. The same as supplied with the transceiver depending on versions.

### ◇ CHARGERS

#### • BC-119N DESKTOP CHARGER + AD-103 CHARGER ADAPTER

##### + BC-145 AC ADAPTER

For rapid charging of battery packs. An AC adapter is supplied with the charger. Charging time: approx. 1.5 to 2 hours

#### • BC-121N MULTI-CHARGER + AD-103 CHARGER ADAPTER (6 pcs.)

##### + BC-124 AC ADAPTER

For rapid charging of up to 6 battery packs (six AD-103's are required) simultaneously. An AC adapter may be supplied depending on version. Charging time: approx. 1.5 to 2 hours.

#### • BC-150 DESKTOP CHARGER + BC-147A/E or BM-95V AC ADAPTER

Used for regular charging of battery pack. The same as supplied with the transceiver. Charging time: approx. 8 hours

### ◇ BELT CLIPS

#### • MB-68 BELT CLIP

#### • MB-74 BELT CLIP

Exclusive alligator-type belt clip.

#### • MB-87 SWIVEL BELT CLIP

Belt clip for swivel type. The same as supplied with the transceiver.

All stated specifications are subject to change without notice or obligation.

**Count on us!**



A-6113H-1EX-①  
Printed in Japan  
© 2001, 2002 Icom Inc.

**Icom Inc.**  
1-1-32 Kamiminami, Hirano-ku, Osaka 547-0003 Japan

---