



INSTRUCTION MANUAL

VHF MARINE TRANSCEIVER
IC-M23

Icom Inc.



FOREWORD

Thank you for choosing this Icom product. This product is designed and built with Icom's state of the art technology and craftsmanship. With proper care this product should provide you with years of trouble-free operation.

IMPORTANT

READ ALL INSTRUCTIONS carefully and completely before using the transceiver.

SAVE THIS INSTRUCTION MANUAL—This instruction manual contains important operating instructions for the IC-M23.

EXPLICIT DEFINITIONS

WORD	DEFINITION
⚠ DANGER!	Personal death, serious injury or an explosion may occur.
⚠ WARNING!	Personal injury, fire hazard or electric shock may occur.
CAUTION	Equipment damage may occur.
NOTE	If disregarded, only inconvenience. No risk of personal injury, fire or electric shock.

FEATURES

Floats on water

The transceiver floats in fresh or salt water even when the supplied accessories are attached.

- When a third-party battery pack, strap, antenna, etc. is used, it may sink.

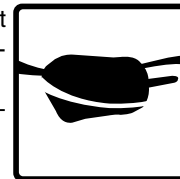

Floats and flashes

An LED sends out intermittent light from a transparent section on the bottom of the transceiver, while floating in the water.

As the LED light stands out in the dark (like a flashing fishing float), the transceiver can be easily retrieved from the water. This function works even when the transceiver is turned OFF.

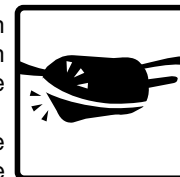

IN CASE OF EMERGENCY

If your vessel requires assistance, contact other vessels and the Coast Guard by sending a distress call on Channel 16.

○ **USING CHANNEL 16**

DISTRESS CALL PROCEDURE

1. "MAYDAY MAYDAY MAYDAY."
2. "THIS IS " (name of vessel)
3. Your call sign or other description of the vessel.
4. "LOCATED AT " (your position)
5. The nature of the distress and assistance required.
6. Any other information which might facilitate the rescue.

RECOMMENDATION

CLEAN THE TRANSCEIVER THOROUGHLY WITH FRESH WATER after exposure to saltwater, and dry it before operating. Otherwise, the transceiver's keys, switches and controllers may become unusable, due to salt crystallization, and/or the charging terminals of the battery pack may rust.

NOTE: If the transceiver's waterproof protection appears defective, carefully clean it with a soft, wet (fresh water) cloth, then, dry it before operating.
The transceiver may lose its waterproof protection if the case, jack cap, or connector cover is cracked or broken, or the transceiver has been dropped.

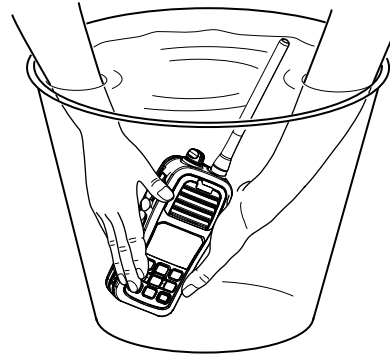

DISPOSAL



The crossed-out wheeled-bin symbol on your product, literature, or packaging reminds you that in the European Union, all electrical and electronic products, batteries, and accumulators (rechargeable batteries) must be taken to designated collection locations at the end of their working life. Do not dispose of these products as unsorted municipal waste. Dispose of them according to the laws in your area.

COUNTRY CODE LIST (ISO 3166-1)

	Country	Codes		Country	Codes
1	Austria	AT	18	Liechtenstein	LI
2	Belgium	BE	19	Lithuania	LT
3	Bulgaria	BG	20	Luxembourg	LU
4	Croatia	HR	21	Malta	MT
5	Czech Republic	CZ	22	Netherlands	NL
6	Cyprus	CY	23	Norway	NO
7	Denmark	DK	24	Poland	PL
8	Estonia	EE	25	Portugal	PT
9	Finland	FI	26	Romania	RO
10	France	FR	27	Slovakia	SK
11	Germany	DE	28	Slovenia	SI
12	Greece	GR	29	Spain	ES
13	Hungary	HU	30	Sweden	SE
14	Iceland	IS	31	Switzerland	CH
15	Ireland	IE	32	Turkey	TR
16	Italy	IT	33	United Kingdom	GB
17	Latvia	LV			

PRECAUTIONS

⚠ DANGER! NEVER short terminals of the battery pack. Also, current may flow into nearby metal objects such as a key, so be careful when placing the battery packs (or the transceiver) in handbags, and so on. Simply carrying with or placing near metal objects such as a key, and so on may cause shorting. This may damage not only the battery pack, but also the transceiver.

⚠ DANGER! Use and charge only specified Icom battery packs with Icom transceivers or Icom chargers. Only Icom battery packs are tested and approved for use with Icom transceivers or charged with Icom chargers. Using third-party or counterfeit battery packs or chargers may cause smoke, fire, or cause the battery to burst.

⚠ WARNING! NEVER connect the transceiver to an AC outlet. This may pose a fire hazard or result in an electric shock.

⚠ WARNING! NEVER hold the transceiver so that the antenna is closer than 2.5 cm from exposed parts of the body, especially the face or eyes, while transmitting. The transceiver will perform best if the microphone is 5 to 10 cm away from the lips and the transceiver is vertical.

CAUTION: NEVER connect the transceiver to a power source other than the BC-199 or BP-266. Such a connection will ruin the transceiver.

CAUTION: MAKE SURE the flexible antenna and battery cover are securely attached to the transceiver, and that the antenna and battery cover are dry before attachment. Exposing the inside of the transceiver to water will result in serious damage to the transceiver.

DO NOT push [PTT] when you do not actually intend to transmit.

DO NOT operate or place the transceiver in direct sunlight or in areas with temperatures below -15°C or above $+55^{\circ}\text{C}$.

DO NOT modify the transceiver. The specifications may change and then not comply with the requirements of a corresponded regulation. The transceiver warranty does not cover any problems caused by unauthorized modification.

DO NOT use harsh solvents such as benzine or alcohol when cleaning, as they will damage the transceiver surfaces.

KEEP the transceiver out of the reach of children.

KEEP the transceiver at least 0.9 meters away from your vessel's magnetic navigation compass.

BE CAREFUL! The transceiver meets IPX7* requirements for waterproof protection. However, once the transceiver has been dropped, waterproof protection cannot be guaranteed because of possible damage to the transceiver's case or the waterproof seal.

* Only when the flexible antenna, battery cover and [DC] jack cap are securely attached.

BE CAREFUL! The transceiver will become hot when operating it continuously for long periods of time.

MAKE SURE to turn OFF the transceiver power before connecting or disconnecting the supplied or optional accessory.

Icom is not responsible for the destruction or damage to the Icom transceiver, if the malfunction is because of:

- Force majeure, including, but not limited to, fires, earthquakes, storms, floods, lightnings, or other natural disasters, disturbances, riots, war, or radioactive contamination.
- The use of Icom transceiver with any equipment that is not manufactured or approved by Icom.

Icom, Icom Inc. and Icom logo are registered trademarks of Icom Incorporated (Japan) in Japan, the United States, United Kingdom, Germany, France, Spain, Russia, Australia, New Zealand, and/or other countries.

TABLE OF CONTENTS

FOREWORD	i	■ Monitor function.....	13
IMPORTANT	i	■ Automatic backlighting	13
EXPLICIT DEFINITIONS.....	i	■ AquaQuake Water Draining function	13
FEATURES.....	i	5 SCAN OPERATION (Except Holland version).....	14–15
IN CASE OF EMERGENCY.....	ii	■ Scan types	14
RECOMMENDATION	ii	■ Setting TAG channels.....	15
DISPOSAL	iii	■ Starting a scan	15
COUNTRY CODE LIST (ISO 3166-1)	iii	6 DUALWATCH/TRI-WATCH (Except Holland version)..	16
PRECAUTIONS.....	iii	■ Description	16
1 OPERATING RULES.....	1	■ Operation.....	16
2 SUPPLIED ACCESSORIES AND ATTACHMENTS....	2–3	7 SET MODE	17–20
■ Supplied accessories	2	■ Set mode programming.....	17
■ Attachments	2	■ Set mode items	18
3 PANEL DESCRIPTION.....	4–7	8 BATTERY CHARGING	21–25
■ Front, top and side panels	4	■ Battery caution	21
■ Function display	6	■ Supplied battery charger.....	23
4 BASIC OPERATION.....	8–13	■ Optional battery charger.....	23
■ Channel selection.....	8	9 TROUBLESHOOTING.....	26
■ Adjusting the volume level.....	10	10 VHF MARINE CHANNEL LIST	27
■ Adjusting the squelch level.....	10	11 SPECIFICATIONS AND OPTIONS	28–29
■ Receiving and transmitting.....	11	■ Specifications	28
■ Call channel programming	12	■ Options.....	29
■ Volume Loud function.....	12		
■ Volume Mute function.....	12		
■ Lock function	13		

◇ **Priorities**

- Read all rules and regulations pertaining to call priorities, and keep an up-to-date copy handy. Safety and distress calls take priority over all others.
- You must monitor Channel 16 when you are not operating on another channel.
- False or fraudulent distress calls are prohibited under law.

◇ **Privacy**

- Information overheard, but not intended for you, cannot lawfully be used in any way.
- Indecent or profane language is prohibited.

◇ **Radio licenses**

(1) SHIP STATION LICENSE

You may require a current radio station license before using the transceiver. It is unlawful to operate a ship station which is not licensed, but required to be.

If required, contact your dealer or the appropriate government agency for a Ship-Radiotelephone license application. This government-issued license states the call sign which is your craft's identification for radio purposes.

(2) OPERATOR'S LICENSE

A Restricted Radiotelephone Operator Permit is the license most often held by small vessel radio operators when a radio is not required for safety purposes.

If required, the Restricted Radiotelephone Operator Permit must be posted or kept with the operator. If required, only a licensed radio operator may operate a transceiver.

However, non-licensed individuals may talk over a transceiver if a licensed operator starts, supervises, ends the call and makes the necessary log entries.

A current copy of the applicable government rules and regulations is only required to be on hand for vessels in which a radio telephone is compulsory. However, even if you are not required to have these on hand it is your responsibility to be thoroughly acquainted with all pertinent rules and regulations.

Supplied accessories

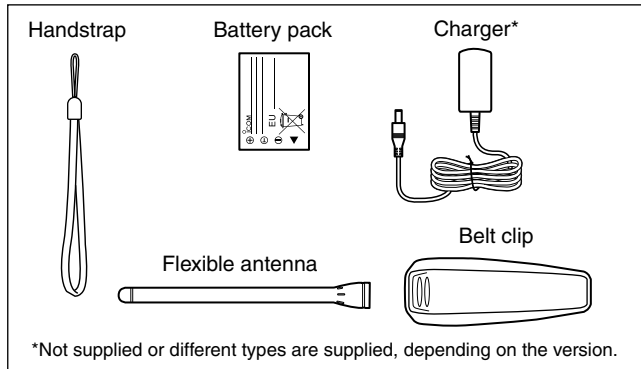

Attachments

Flexible antenna

Connect the supplied flexible antenna to the antenna connector.

CAUTION:

- **NEVER** carry the transceiver by holding just the antenna.
- Transmitting without an antenna can damage the transceiver.

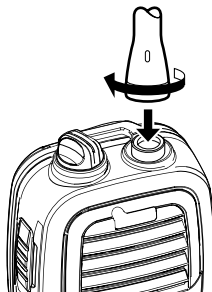

Handstrap

Pass the handstrap through the loop on the back side of the transceiver as shown.

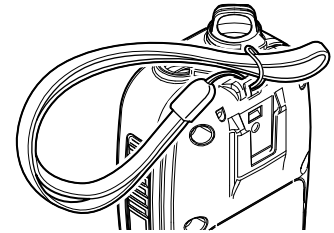

Belt clip

Attach the belt clip to, or detach the belt clip from the transceiver.

To attach the belt clip

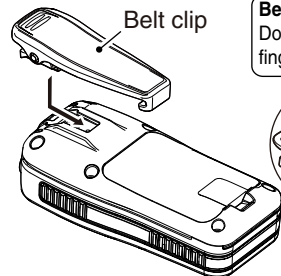

To detach the belt clip

Lift the tab up (1), and slide the belt clip in the direction of the arrow (2).

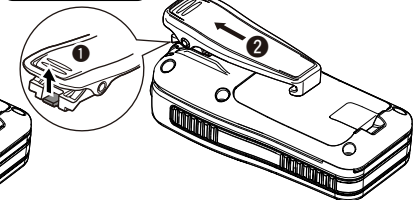

◆ **Battery pack**

To remove the battery pack:

Slide the latch and then lift the battery cover to remove it. Then remove the battery pack, as shown.

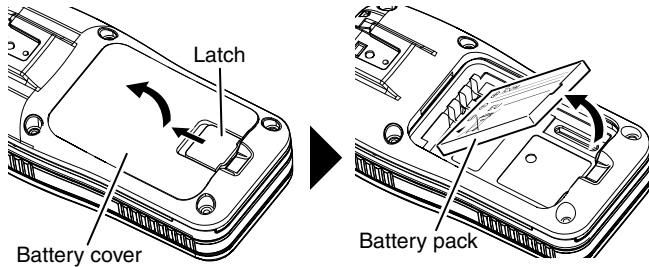

To insert the battery pack:

Place the battery pack into the transceiver so it fits flat, and then securely attach the battery cover, as shown.

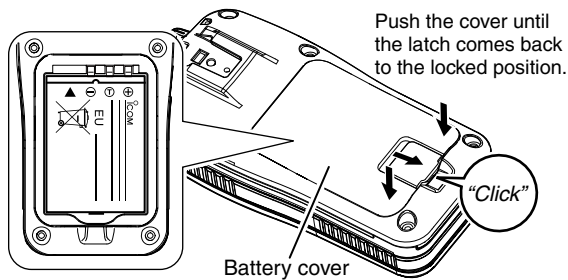

NEVER remove the battery cover when the transceiver is wet or soiled. This may result in water or dust getting into the transceiver/battery pack, and may result in the transceiver being damaged.

CAUTION:

- When attaching or removing the battery cover, make sure the rubber seal is correctly set in the groove of the cover. If the seal is not correctly in the groove, it may be damaged when attaching the battery cover. If the seal is damaged, waterproof protection is not guaranteed.
- When attaching the battery cover, make sure dust or other material does not adhere to the rubber seal. If dust or other material is on the seal when attaching the battery cover, waterproof protection may not be guaranteed.

Make sure the rubber seal is properly seated in the groove and there is dust or other material is on it.

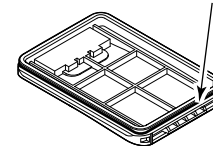

Correct position

Incorrect position

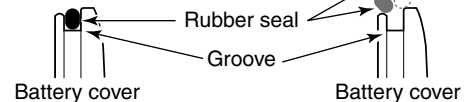

■ Front, top and side panels

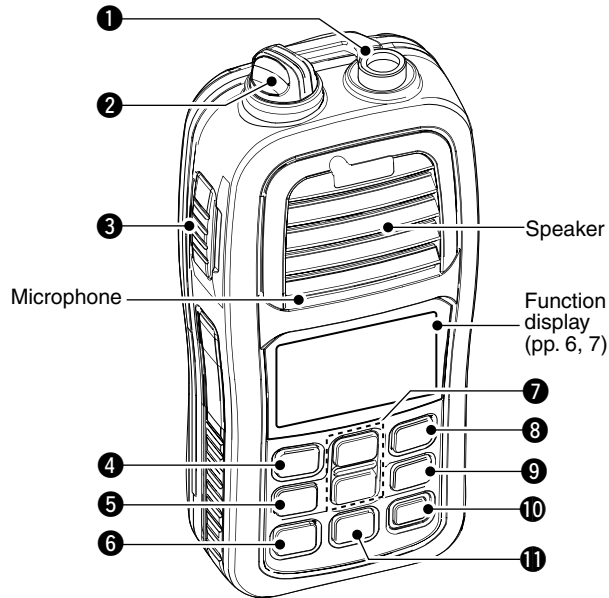

1 ANTENNA CONNECTOR (p. 2)

Connect the supplied antenna here.

2 DC JACK [DC] (p. 23)

Connect the charger or optional cable here.

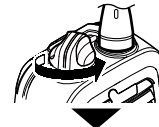

NOTE: Attach the [DC] jack cap when the charger or optional cable is not connected. Otherwise, water will get into the transceiver. When attaching the [DC] jack cap, make sure dust or other material does not adhere to the rubber seal. If dust or other material is on the seal when attaching the cap, waterproof protection may not be guaranteed.

3 PTT SWITCH [PTT]

Hold down to transmit; release to receive. (p. 11)

4 CHANNEL 16 KEY [16 C]

➔ Push to select Channel 16. (p. 8)

➔ Hold down for 1 second to select the Call channel. (p. 8)

➔ When the Call channel is selected, hold down for 3 seconds to enter the Call channel programming mode. (p. 12)

➔ While in the Set mode, push to return to the normal operating mode. (p. 17)

5 VOLUME/SQUELCH/MONITOR KEY [VOL/SQL MONI]

- ➔ Push to enter the volume adjustment mode or the squelch adjustment mode. (p. 10)

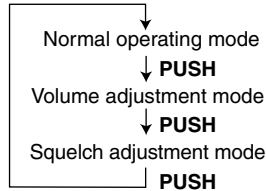

- ➔ Hold down for 1 second to activate the Monitor function. (p. 13)
- ➔ While holding down this key, hold down [⏻] to turn ON the power and enter the Set mode. (p. 17)
- ➔ While in the Set mode, push to select an item. (p. 17)
- ➔ While holding down this key, push [▼] to turn ON the Volume Mute function. Do the same steps again to turn OFF the function. (p. 12)
- ➔ While holding down this key, push [▲] to turn ON the Volume Loud function. Do the same steps again to turn OFF the function. (p. 12)

6 SCAN/DUAL KEY [SCAN DUAL]

- ➔ Push to start or stop a normal or priority scan. (p. 15)
- ➔ Hold down for 1 second to enter the Dual/Tri-watch mode. (p. 16)
- ➔ Push to exit the watch mode. (p. 16)
- ➔ Hold down this key and [Hi/Lo] for 1 second, to activate the AquaQuake function. (p. 13)

7 UP/DOWN KEYS [▲] or [▼]

- ➔ Push to select an operating channel. (pp. 8, 9)
- ➔ While in the Set mode, push to select the setting or value of an item. (p. 17)
- ➔ Push to check TAG channels or change scanning direction during a scan. (p. 15)

8 FAVORITE/TAG KEY [FAV TAG]

- ➔ Push to sequentially select the favorite (TAG) channels, while ignoring untagged channels, in a channel group. (p. 8)
- ➔ Hold down for 1 second to set or clear the TAG for the displayed channel. (p. 15)
- ➔ While holding down, turn ON the power to clear or set all TAG channels in the selected channel group. (p. 15)

9 CHANNEL KEY [CH]

- ➔ Hold down for 1 second, one or more times, to select a channel group from USA*¹, International, Canada*² and ATIS*³. (p. 9)
 - ➔ Push to return to the previous channel before selecting Channel 16 or the Call channel. (p. 8)
- *¹ U.K. and China versions only.
 *² China version only.
 *³ German and Holland versions only.

10 POWER KEY [⏻]

Hold down to turn power ON or OFF.

11 TRANSMIT POWER/LOCK KEY [Hi/Lo 

- ➔ Push to select the high or low output power. (p. 11)
- ➔ Hold down for 1 second to turn the Lock function ON or OFF. (p. 13)

3 PANEL DESCRIPTION

■ Function display

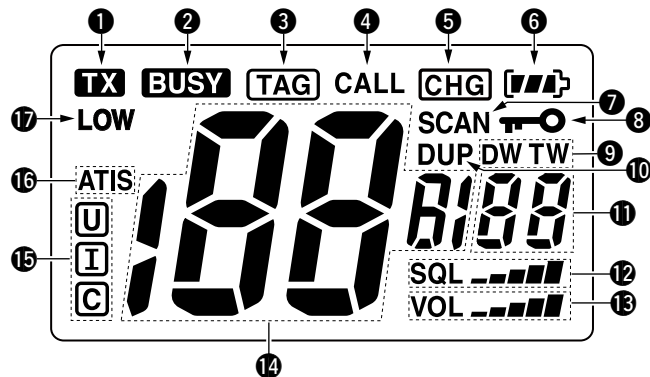

- 1 TRANSMIT ICON** (p. 11)
Appears while transmitting.
- 2 BUSY ICON**
→ Appears while receiving a signal or when the squelch opens. (p. 11)
→ Blinks while monitoring. (p. 13)
- 3 TAG CHANNEL ICON** (p. 15)
Appears when a TAG channel is selected.
- 4 CALL CHANNEL ICON** (p. 8)
Appears when the Call channel is selected.

- 5 CHARGE ICON** (p. 23)
Appears while charging.

- 6 BATTERY ICONS**
→ Displays the remaining battery capacity.

Indication	[]	[]	[]	[]
Battery status	Full	Middle	Charging required	Exhausted

[||||] blinks when the battery is over charged.

→ Scrolls while charging. (p. 23)

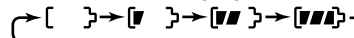

- 7 SCAN ICON** (p. 15)
Blinks during a scan.
- 8 LOCK ICON** (p. 13)
Appears when the Lock function is turned ON.
- 9 DUALWATCH/TRI-WATCH ICONS** (p. 16)
“DW” appears during Dualwatch; “TW” appears during Tri-watch.
- 10 DUPLEX ICON**
Appears when a duplex channel is selected.

11 SUB CHANNEL READOUT

- Displays Channel 16 during a priority scan, Dualwatch or Tri-watch. (p. 16)
- Displays the Set mode item while in the Set mode. (p. 17)
- Displays the volume level while in the volume adjustment mode. (p. 10)
- Displays the squelch level while in the squelch adjustment mode. (p. 10)

12 SQUELCH LEVEL ICON

- Displays the squelch level.
- “SQL” blinks while adjusting the squelch level. (p. 10)

13 VOLUME LEVEL ICON

- Displays the volume level.
- The bars repeatedly appear in ascending order when the Volume Loud function is turned ON. (p. 12)
- The bars blink while the Volume Mute function is turned ON. (p. 12)
- “VOL” blinks while adjusting the volume level. (p. 10)

14 CHANNEL NUMBER READOUT

- Displays the selected operating channel number.
- In the Set mode, displays the selected setting or value. (p. 17)

15 CHANNEL GROUP ICON (p. 9)

- “U” appears when USA; “I” appears when International;
- “C” appears when Canadian channel group is selected.

16 ATIS ICON (p. 9)

- “ATIS” appears when the channel group, which ATIS function is activated, is selected.
(Available with German and Holland versions only.)

17 LOW POWER ICON (p. 11)

- “LOW” appears when low power is selected.
- “LOW” blinks when switching to the low power mode is forced because of a high temperature error or low voltage.

■ Channel selection

IMPORTANT: Prior to using the transceiver for the first time, the battery pack must be fully charged for optimum life and operation (p. 23). To avoid damage to the transceiver, turn OFF the power while charging.

◇ Channel 16

Channel 16 is the distress and safety channel. It is used for establishing initial contact with a station, and for emergency communications. Channel 16 is monitored during both Du-alwatch and Tri-watch. While in the standby mode, you must monitor Channel 16.

- ① Push **[16]** momentarily to select Channel 16.
- ② Push **[CH]** to return to the channel used before selecting Channel 16, or push **[▲]** or **[▼]** to select a different channel.

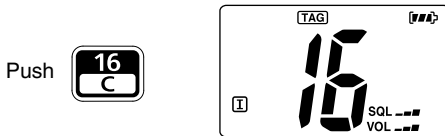

◇ Call channel

Each regular channel group has a separate leisure-use Call channel. The Call channel is monitored during Tri-watch. The Call channels can be programmed, and are used to store your most often used channel in each channel group, for quick recall. (p. 12)

- ① Hold down **[C]** (16) for 1 second to select the Call channel of the selected channel group.
 - “CALL” and the Call channel number appear.
- ② Push **[CH]** to return to the channel used before selecting the Call channel, or push **[▲]** or **[▼]** to select a different channel.

Hold down
for 1 second



Convenient!

While holding down **[FAV]**, push **[▲]** or **[▼]** to select the favorite (TAG) channels.

- Pushing **[FAV]** only advances the displayed TAG channel.
- The favorite channels are selected using the TAG channel setting. (p. 15)

◇ **USA, International, Canadian and ATIS channels**

The transceiver is pre-programmed with USA*1, International, Canadian*2 and ATIS*3 channels. Choose the appropriate channel groups for your operating area.

- ① Push [CH] to select a regular channel.
- ② Hold down [CH] for 1 second, one or more times, to select the desired channel group.
 - The selectable channel groups are different, depending on the version.
- ③ Push [▲] or [▼] to select a channel.
 - “DUP” appears for duplex channels.
 - “A” appears when a simplex channel is selected.

*1 U.K. and China versions only.

*2 China version only.

*3 German and Holland versions only.

For UK version

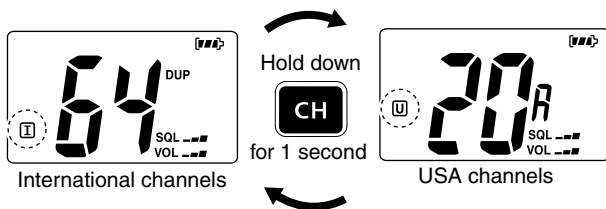

For German and Holland versions

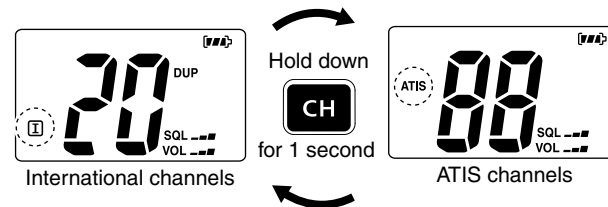

For China version

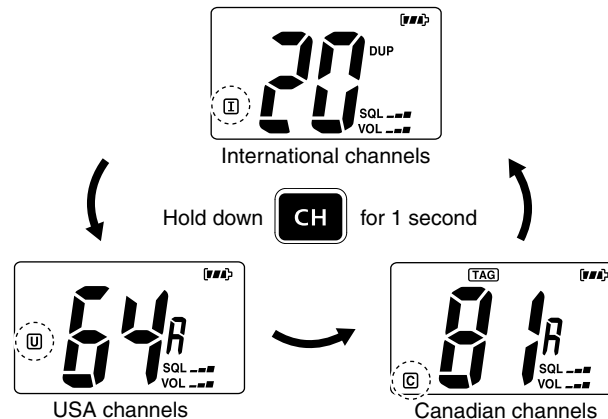

4 BASIC OPERATION

■ Adjusting the volume level

The volume level can be adjusted using [VOL/SQL] and [▲] or [▼].

- ① Push [VOL/SQL] once to enter the volume adjustment mode, then push [▲] or [▼] to adjust the volume level.
 - The “VOL” icon starts blinking.
 - The transceiver has 31 volume levels and OFF.
 - When no key operation is performed for 5 seconds, the transceiver returns to the normal mode.
- ② Push [VOL/SQL] twice to exit the volume adjustment mode.

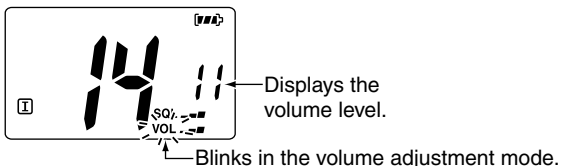

■ Adjusting the squelch level

The squelch level can be adjusted using [VOL/SQL] and [▲] or [▼].

In order to properly receive signals, as well as for the scan to effectively function, the squelch must be adjusted to the proper level.

- ① Push [VOL/SQL] twice to enter the squelch adjustment mode, then push [▲] or [▼] to adjust the squelch level.
 - The “SQL” icon starts blinking.
 - The transceiver has 11 squelch levels: OP is completely open; 10 is tight squelch; 1 is loose squelch.
 - When no key operation is performed for 5 seconds, the transceiver returns to the normal mode.
- ② Push [VOL/SQL] again to exit the squelch adjustment mode.

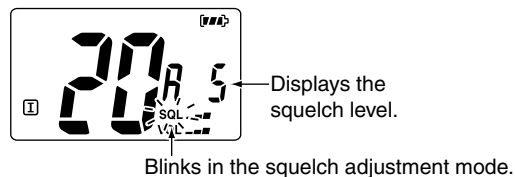

■ Receiving and transmitting

CAUTION: Transmitting without an antenna can damage the transceiver.

- ① Hold down [⏻] to turn ON the power.
- ② Set the volume and squelch levels.
You can enter each adjustment mode by pushing [VOL/SQL].
 - ➔ Enter the squelch adjustment mode, and then push [▼] one or more times to open the squelch.
 - ➔ Enter the volume adjustment mode, and then push [▲] or [▼] to adjust the volume level.
 - ➔ Enter the squelch adjustment mode again, and push [▲] until the noise just disappears.
- ③ Push [VOL/SQL] again to exit the squelch adjustment mode.
- ④ Push [▲] or [▼] to select a desired channel.
 - When receiving a signal, “**BUSY**” appears and audio is heard from the speaker.
 - You may want to further adjust the audio level.
- ⑤ Push [Hi/Lo] to select the output power if necessary.
 - “**LOW**” appears when low power is selected; no icon is displayed when high power is selected.
 - Choose low power for short range communications; choose high power for longer distance communications.
 - Some channels are for only low power communication.
- ⑥ Hold down [PTT] to transmit, then speak into the microphone.
 - “**TX**” appears.
 - Channel 70 cannot be used for transmission.
- ⑦ Release [PTT] to receive.

IMPORTANT: To maximize the readability of your transmitted signal, pause for a second after pushing [PTT], hold the microphone 5 to 10 cm from your mouth and speak into the microphone at a normal voice level.

NOTE: To conserve battery power, the transceiver’s Power Save function automatically activates when no signal is received for 5 seconds.

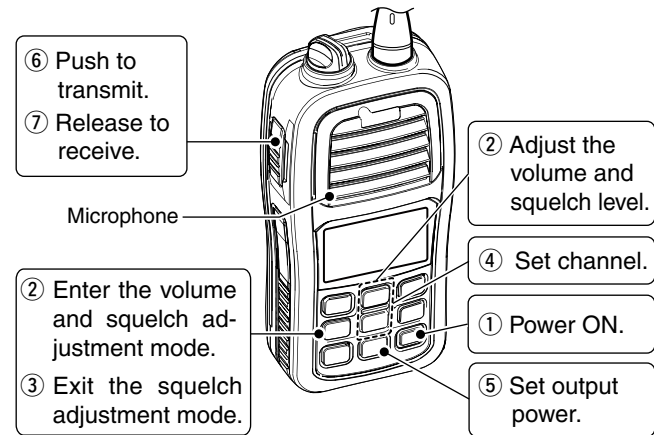

4 BASIC OPERATION

■ Call channel programming

Call channel is used to access Channel 16 (default; may differ depending on the version). However, you can program the Call channel with your most often-used channel in each channel group, for quick recall.

- ① Hold down **[CH]** for 1 second, one or more times, to select the desired channel group to be programmed. (p. 9)
- ② Hold down **[C]** (16) for 1 second to select the Call channel of the selected channel group.
 - “CALL” and the Call channel number appear.

- ③ Hold down **[C]** (16) again for 3 seconds (until a long beep changes to 2 short beeps) to enter the Call channel programming mode.
 - The channel number starts blinking.

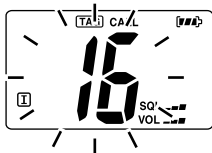

- ④ Push **[▲]** or **[▼]** to select the desired channel.
- ⑤ Push **[C]** (16) to program the displayed channel as the Call channel.
 - The channel number stops blinking.

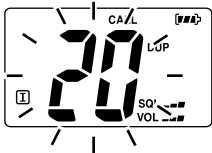

■ Volume Loud function

The Volume Loud function temporarily maximizes the volume level.

/// This function has no effect when the volume level is 31.

- ① While holding down **[VOL/SQL]**, push **[▲]** to turn ON the Volume Loud function.
 - The volume level is set to the maximum level (level 31).
 - The bars of the volume level icon repeatedly appear in ascending order.
- ② Push **[VOL/SQL]** and **[▲]** again to turn OFF the Volume Loud function.

■ Volume Mute function

The Volume Mute function temporarily mutes the audio output.

/// This function has no effect when the volume level is OFF.

- ① While holding down **[VOL/SQL]**, push **[▼]** to turn ON the Volume Mute function.
 - The volume level is set to the minimum level (OFF).
 - The bars of the volume level icon blink.
- ② Push **[VOL/SQL]** and **[▼]** again to turn OFF the Volume Mute function.

■ Lock function

This function electronically locks all keys (except for [PTT], [VOL/SQL], [MONI] (VOL/SQL), [Hi/Lo] and [▲] or [▼]*) to prevent accidental changing of the channel and function access.

* Only in the volume or squelch adjustment mode, and volume loud and Volume Mute functions.

➔ Hold down [Hi/Lo] (Hi/Lo) for 1 second to turn the Lock function ON and OFF.

Appears while the Lock function is activated.

Hold down
for 1 second



■ Monitor function

The Monitor function opens the squelch. The monitor key action can be selected in the Set mode. (p. 19)

➔ The Monitor function is activated by holding down [MONI] (VOL/SQL).

- "BUSY" blinks and the squelch opens.

Blinks while the monitor function is activated.

Hold down

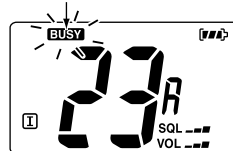

■ Automatic backlighting

This function lights the function display and keys, and is convenient for night-time operation. The automatic backlighting can be activated in the Set mode. (p. 19)

- ➔ Push any key except for [PTT] to turn ON the backlight.
 - The backlight is automatically turned OFF after 5 seconds of inactivity.

4

■ AquaQuake Water Draining function

The AquaQuake Water Draining function removes water from the speaker grill. Without this function, water may muffle the sound coming from the speaker. The transceiver makes a vibrating sound when this function is activated.

- ➔ Hold down both [SCAN] and [Hi/Lo].
 - A low vibration tone sounds for 9 seconds to drain water, regardless of the volume level setting.
 - The transceiver does not accept key operations while the AquaQuake Water Draining function is activated.

■ Scan types

Scanning is an efficient way to quickly locate signals over a wide frequency range. The transceiver has a priority scan and a normal scan.

In addition, the Auto Scan function is selectable for standby convenience. This function can be simultaneously activated, depending on the setting in the Set mode. (p. 18)

Set the TAG channels (scanned channels) before scanning. Clear the TAG for unwanted channels which inconveniently stop scanning, such as those for digital communications. (p. 15)

Choose the desired scan type from "Priority" or "Normal" in the Set mode. (p. 18)

PRIORITY SCAN

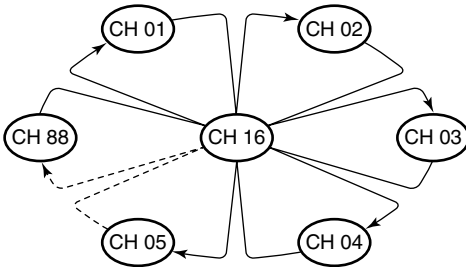

A priority scan sequentially searches through all TAG channels while monitoring Channel 16. When a signal is detected on Channel 16, the scan pauses until the signal disappears; when a signal is detected on a channel other than Channel 16, the scan switches to Dualwatch, until the signal disappears.

NORMAL SCAN

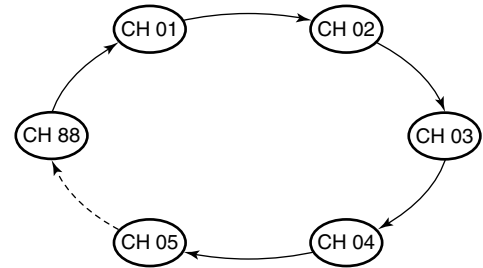

A normal scan, like a priority scan, sequentially searches through all TAG channels. However, unlike a priority scan, Channel 16 is not checked unless Channel 16 is set as a TAG channel.

■ Setting TAG channels

For more efficient scanning, add the desired channels as TAG channels, or clear the TAG on unwanted channels.

Channels that are not tagged will be skipped while scan. TAG channels can be independently assigned to each USA, International, Canada and ATIS channel group.

- ① Hold down **[CH]** for 1 second one or more times to select the desired channel group.
- ② Select the desired channel to be set as a TAG channel.
- ③ Hold down **[TAG]** (FAV) for 1 second to set the displayed channel as a TAG channel.
 - “**TAG**” appears on the display.
- ④ To cancel a TAG channel setting, hold down **[TAG]** (FAV) for 1 second.
 - “**TAG**” disappears.

✓ Clearing (or setting) all tagged channels

While holding down **[TAG]** (FAV), turn ON the power to clear all TAG channels in the selected channel group.

- Repeat above procedure to set all channels as TAG channels (when no TAG channel has been set.)

■ Starting a scan

Set the Priority Scan function, Scan Resume Timer and Auto Scan function in advance, in the Set mode. (p. 18)

- ① Hold down **[CH]** for 1 second one or more times to select a desired channel group.
- ② Push **[SCAN]** to start a priority or normal scan.
 - “**SCAN**” blinks while scanning.
 - “16” appears on the sub channel readout during a priority scan.
 - When a signal is received, the scan pauses until the signal disappears, or resumes after pausing 5 seconds, depending on the Set mode setting.
 - Push **[▲]** or **[▼]** to sequentially select TAG channels, change the scanning direction or manually resume the scan.
- ③ To stop the scan, push **[SCAN]** again.
 - “**SCAN**” disappears.
 - Pushing **[PTT]**, **[16]**, **[CH]** or **[FAV]** also stops the scan.

[Example]: Starting a normal scan.

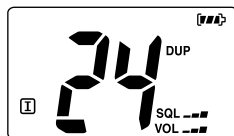

Scanning starts

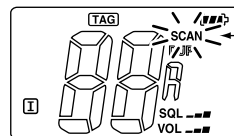

← Blinks

→ Appears

When a signal is received

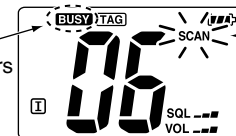

← Blinks

Description

Dualwatch monitors Channel 16 while you are receiving on another channel; Tri-watch monitors Channel 16 and the Call channel while receiving another channel. Dualwatch/Tri-watch are convenient for monitoring Channel 16 when you are operating on another channel.

DUALWATCH/TRI-WATCH SIMULATION

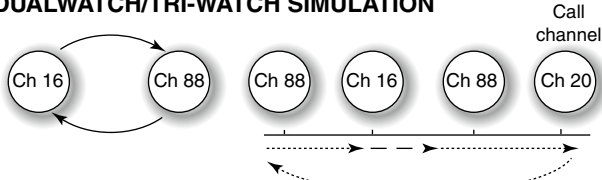

Dualwatch

Tri-watch

- If a signal is received on Channel 16, Dualwatch/Tri-watch pauses on Channel 16 until the signal disappears.
- If a signal is received on the Call channel during Tri-watch, Tri-watch becomes Dualwatch until the signal disappears.
- To transmit on the selected channel during Dualwatch/Tri-watch, Hold down [PTT].

Operation

- ① Select Dualwatch or Tri-watch in the Set mode. (p. 19)
- ② Select the desired channel.
- ③ Hold down [DUAL] (SCAN) for 1 second to start Dualwatch or Tri-watch, depending on the Set mode setting.
 - “DW” blinks during Dualwatch; “TW” blinks during Tri-watch.
 - A beep tone sounds when a signal is received on Channel 16.
 - Tri-watch switches to Dualwatch when receiving a signal on the Call channel.
- ④ To cancel Dualwatch/Tri-watch, push [DUAL] (SCAN) again.

[Example]: Operating Tri-watch on INT channel 07.

Tri-watch starts.

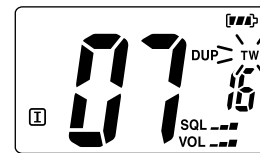

A signal is received on the Call channel.



Tri-watch resumes after the signal disappears.

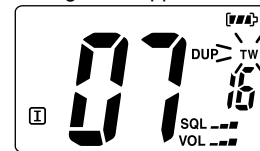

The signal received on Channel 16 takes priority.

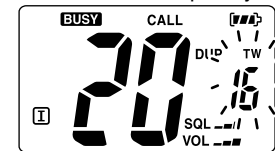

■ Set mode programming

The Set mode is used to change the settings of transceiver's functions: Beep Tone function, Priority Scan function*, Scan resume timer*, Auto Scan function*, Dual/Tri-watch function*, Monitor key action, Automatic backlighting, LCD contrast setting and Power Save function.

*Not available with Holland version.

◇ Set mode operation

- ① Turn OFF the power.
- ② While holding down [VOL/SQL], turn ON the power to enter the Set mode.
 - "bP" appears.
- ③ Push [VOL/SQL] to select a desired item. Or while holding down [VOL/SQL], push [▲] or [▼] also selects an item.
- ④ Push [▲] or [▼] to select a desired option of the item.
- ⑤ To exit the Set mode, push [16].

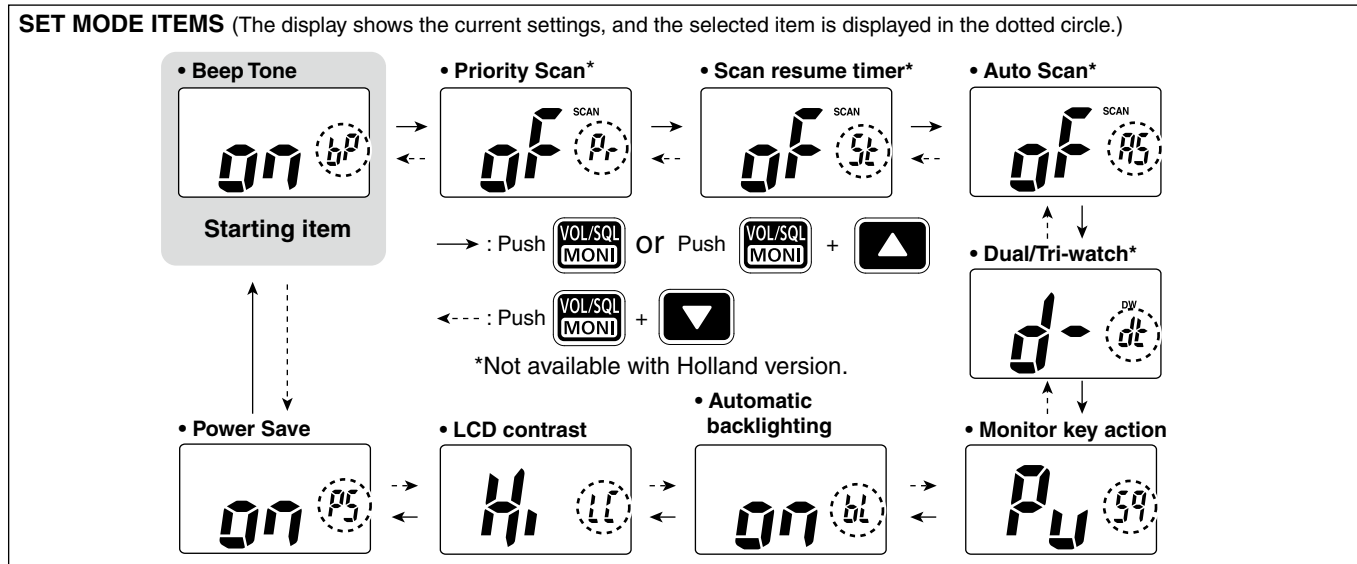

■ Set mode items

◇ Beep Tone function

Turn the key touch beep sound ON or OFF.

- OFF: For silent operation.
- ON : A beep sounds.

“bP”



Beep tone ON (default)



Beep tone OFF

◇ Priority Scan function

(Not available with Holland version)

The transceiver has 2 scan types— normal (OFF) and priority (ON) scan. A normal scan searches all TAG channels in the selected channel group. A priority scan sequentially searches all TAG channels while monitoring Channel 16.

“Pr”



Normal scan (default)



Priority scan

◇ Scan resume timer

“St”

(Not available with Holland version)

The Scan resume timer can be set as a pause (OFF) or timer scan (ON).

- OFF: When a signal is detected, the scan pauses on the channel until the signal disappears, and then resumes.
- ON : When a signal is detected, the scan pauses on the channel for 5 seconds, and then resumes.

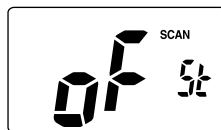

Scan resume timer OFF (default)



Scan resume timer ON

◇ Auto Scan function

“AS”

(Not available with Holland version)

The Auto Scan function automatically starts a normal or priority scan when no signal is received, and no operation is performed for 30 seconds.



Auto scan OFF (default)



Auto scan ON

◇ **Dual/Tri-watch function** “dt”

(Not available with Holland version)

Set the watch type to Dualwatch or Tri-watch. (p. 16)

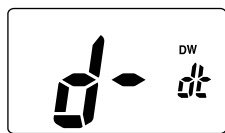

Dualwatch function
(default)



Push

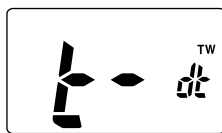

Tri-watch function

◇ **Monitor key action** “Sq”

The monitor key temporarily opens the squelch. This item sets the key action.

- Pu (PUSH) : The Monitor function is activated by holding down [MONI] (VOL/SQL). The squelch stays open while holding down the key.
- Ho (HOLD) : The Monitor function is activated by holding down [MONI] (VOL/SQL) for 1 second. The squelch stays open until any key is pushed.

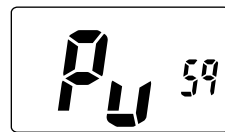

Push setting (default)



Push

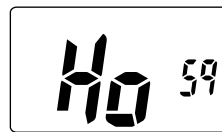

Hold setting

◇ **Automatic backlighting** “bl”

This function is convenient for night-time operation. The backlight can be selected from ON and OFF.

- The backlight is automatically activated when any key except [PTT] is pushed.
- The backlight is automatically turned OFF after 5 seconds of inactivity.



Auto backlighting ON
(default)



Push



Auto backlighting OFF

◇ **LCD contrast setting** “LC”

Set the LCD contrast level to High contrast or Low contrast.

☞ The LCD contrast level has little effect during indoor use.



High contrast (default)



Push

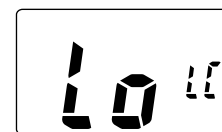

Low contrast

7 SET MODE

◇ Power Save function

“PS”

The Power Save function reduces current drain by turning OFF the receiver circuit for preset intervals.

- OFF : The Power Save function is turned OFF.
- ON : The Power Save function is turned ON. The Power Save function will be activated when no signal is received, and no operation is performed for 5 seconds



Power Save ON
(default)



Push



Power Save OFF

■ Battery caution

Misuse of Lithium-ion batteries may result in the following hazards: smoke, fire, or the battery may rupture. Misuse can also cause damage to the battery or degradation of battery performance.

◇ Battery caution

⚠ **DANGER! DO NOT** hammer or otherwise impact the battery. Do not use the battery if it has been severely impacted or dropped, or if the battery has been subjected to heavy pressure. Battery damage may not be visible on the outside of the case. Even if the surface of the battery does not show cracks or any other damage, the cells inside the battery may rupture or catch fire.

⚠ **DANGER! NEVER** use or leave battery pack in areas with temperatures above +50°C. High temperature buildup in the battery, such as could occur near fires or stoves, inside a sun-heated vehicle, or by setting the battery in direct sunlight for long periods of time may cause the battery to rupture or catch fire. Excessive temperatures may also degrade battery performance or shorten battery life.

⚠ **DANGER! DO NOT** expose the battery to rain, snow, saltwater, or any other liquids. Never charge or use a wet battery. If the battery gets wet, be sure to wipe it dry before using. The battery by itself is not waterproof.

⚠ **DANGER! KEEP** battery packs away from fire. Fire or heat may cause them to rupture or explode. Dispose of an used battery pack according to local ordinances and/or regulations.

⚠ **DANGER! NEVER** solder the battery terminals, or **NEVER** modify the battery pack. This may generate heat in the battery, and the battery pack may burst, emit smoke or catch fire.

⚠ **DANGER!** Use the battery only with the transceiver for which it is specified. Never use a battery with any other equipment, or for any purpose that is not described in this instruction manual.

⚠ **DANGER!** If fluid from inside the battery gets in your eyes, blindness can result. Rinse your eyes with clean water, without rubbing them, and see a doctor immediately.

⚠ **WARNING!** Immediately stop using the battery if it emits an abnormal odor, heats up, or is discolored or deformed. If any of these conditions occur, contact your Icom dealer or distributor.

⚠ **WARNING!** Immediately wash, using clean water, any part of the body that comes into contact with fluid from inside the battery.

⚠ **WARNING! NEVER** put the battery in a microwave oven, high-pressure container, or in an induction heating cooker. This could cause overheating, a fire, or cause the battery to rupture.

CAUTION: Always use the battery within the specific temperature range for the transceiver (−15°C to +55°C) and the battery itself (−20°C to +60°C). Using the battery out of its specific temperature range will reduce the battery's performance and battery life. Please note that the specified temperature range of the battery may exceed that of the transceiver. In such cases, the transceiver may not work properly because it is out of its operating temperature range.

8 BATTERY CHARGING

■ Battery caution (continued)

CAUTION: Shorter battery life could occur if the battery is left fully charged, completely discharged, or in an excessive temperature environment (above +50°C) for an extended period of time. If the battery must be left unused for a long time, it must be detached from the transceiver after discharging. You may use the battery until the remaining capacity is about half, then keep it safely in a cool dry place with the temperature range as follows:

- 20°C to +50°C (within a month)
- 20°C to +35°C (within three months)
- 20°C to +25°C (within a year)

BE SURE to replace the battery pack with a new one approximately five years after manufacturing, even if it still holds a charge. The inside battery material will become weak after a period of time, even with little use. The estimated number of times you can charge the battery is between 300 and 500.

Even when the battery appears to be fully charged, the operating time of the transceiver may become short when:

- Approximately five years have passed since the battery was manufactured.
- The battery has been repeatedly charged.

◇ Charging caution

Charge the battery pack at least once every six months, even if it has been not used for a long period of time. The battery pack will have slowly self-discharged, even though it has not been used. If the battery pack is left for a long period without being charged, its life cycle will be shorter, or worse, it will never accept a charge again.

Due to the characteristics of the Li-ion rectangular battery, the battery pack may change its shape as the charge and discharge cycles are repeated. This is a normal phenomenon, and it is quite safe to continue to use the pack, as long as it is properly handled. However, when the shape of the battery pack is so changed that the battery pack or battery cover can not be correctly attached to the transceiver, it is time to replace it with a new one. Otherwise, the transceiver can be damaged due to the loss of air tightness.

⚠ **DANGER! NEVER** charge the battery pack in areas with extremely high temperatures, such as near fires or stoves, inside a sun-heated car, or in direct sunlight. In such environments, the safety/protection circuit in the battery will activate, causing the battery to stop charging.

⚠ **WARNING! NEVER** charge the transceiver during a lightning storm. It may result in an electric shock, cause a fire or damage the transceiver. Always disconnect the power adapter before a storm.

⚠ **WARNING! DO NOT** charge or leave the battery in the battery charger beyond the specified time for charging. If the battery is not completely charged by the specific time, stop charging and remove the battery from the battery charger. Continuing to charge the battery beyond the specific time limit may cause a fire, overheating, or the battery may rupture.

⚠ **WARNING! NEVER** insert the transceiver (battery attached to the transceiver) into the charger if it is wet or soiled. This could corrode the battery charger terminals or damage the charger. The charger is not waterproof.

CAUTION: DO NOT charge the battery outside of the specified temperature range: ±0°C to +45°C. Icom recommends charging the battery at +20°C. The battery may heat up or rupture if charged out of the specified temperature range, and battery performance or battery life may be reduced.

■ Supplied battery charger

◇ Charging

⚡ Do not use a charger other than the specified one.

- ① Turn OFF the transceiver's power.
- ② Connect the charger as shown below.
 - “CHG” appears, and the battery icon scrolls while charging.

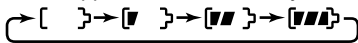

- ③ The charging is completed in approximately 8.5 hours, depending on the remaining capacity before charging.
 - “CHG” and “[Full Battery Icon]” appear, and “FL” is also displayed on the function display when charging is completed.

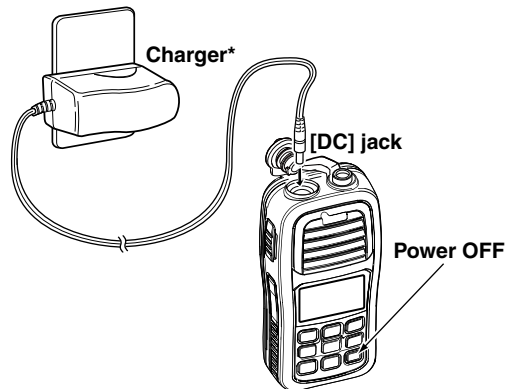

*Not supplied or different types are supplied, depending on the version.

NOTE: “[Full Battery Icon]” and “CHG” blink, and “Er” is also displayed on the function display, when the battery pack is not attached.

■ Optional battery charger

- ⚡ Do not place the charger on a surface with any vibration.
- ⚡ Otherwise the battery pack might come out of the charger, or the charger itself might fall.

◇ AD-123 installation

The AD-123 CHARGER ADAPTER must be installed into the BC-119N DESKTOP CHARGER or BC-121N MULTI-CHARGER before charging.

- ① Connect the AD-123 and the BC-119N or BC-121N as shown.

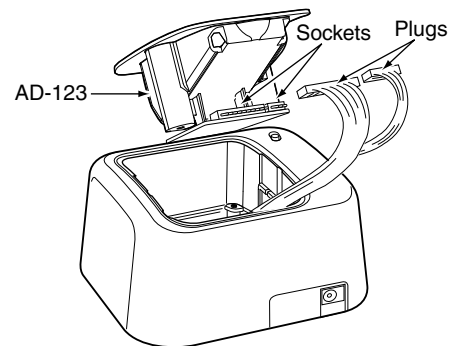

This illustration is for the BC-119N.

8 BATTERY CHARGING

◇ AD-123 installation (continued)

- ② Install the AD-123 into the holder space of the BC-119N or BC-121N with the supplied screws as shown.

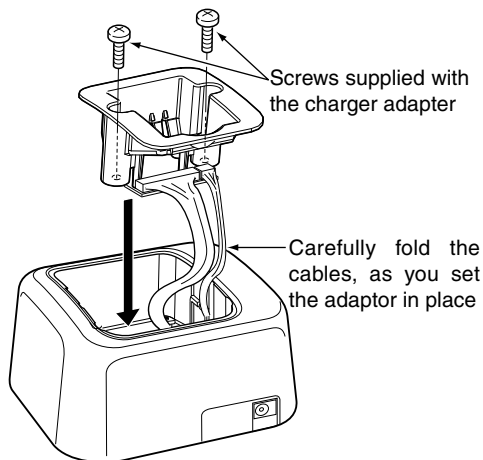

This illustration is for the BC-119N.

◇ Charging

• For BC-119N

The optional BC-119N provides rapid charging of the Li-ion battery pack. (Charging time: Approximate 2.5 hours)

The following items are additionally required:

- AD-123 CHARGER ADAPTER (purchase separately)
- A power adapter (may be supplied with BC-119N depending on version) or the DC power cable (OPC-515L/CP-23L).

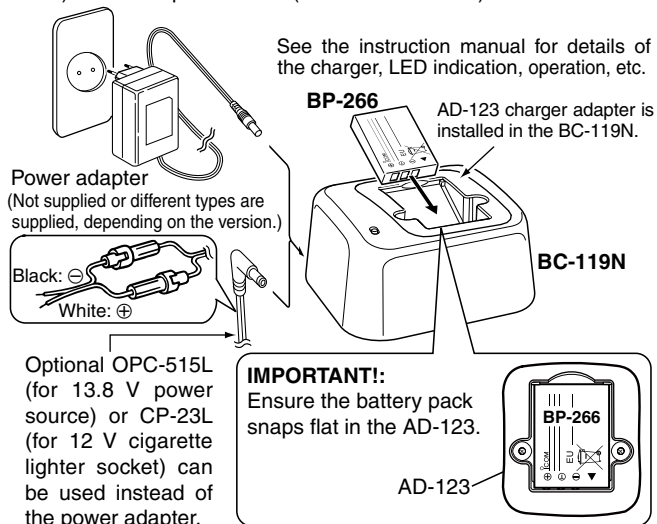

IMPORTANT!
Ensure the battery pack snaps flat in the AD-123.

CAUTION: When using the OPC-515L DC power cable **NEVER** reverse the polarity of an OPC-515L connected between a power source and the battery charger. This will ruin the charger.
White line: + Black line: -

• **For BC-121N**

The optional BC-121N allows up to six battery packs to be charged simultaneously.

Charging time: Approximate 2.5 hours

The following items are additionally required.

- Six AD-123 CHARGER ADAPTERS (purchase separately)
- A power adapter or the DC power cable (OPC-656)

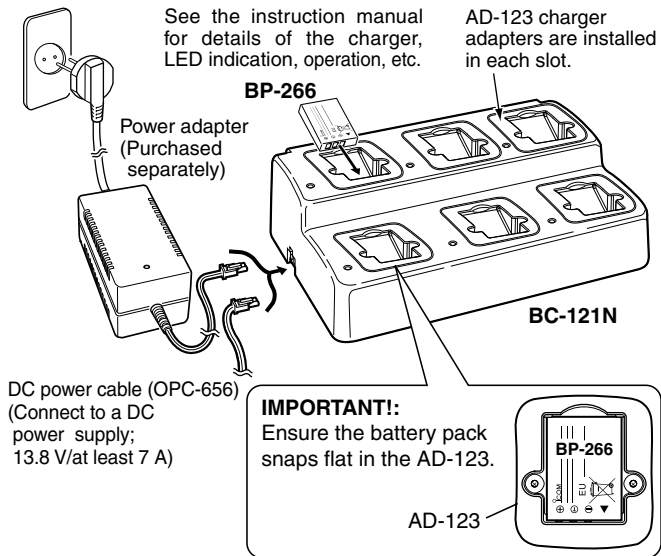

◇ **Charging from a cigarette lighter socket**

Use the optional CP-24 CIGARETTE LIGHTER CABLE charge from a cigarette lighter socket.

Charging time: Approximate 8.5 hours.

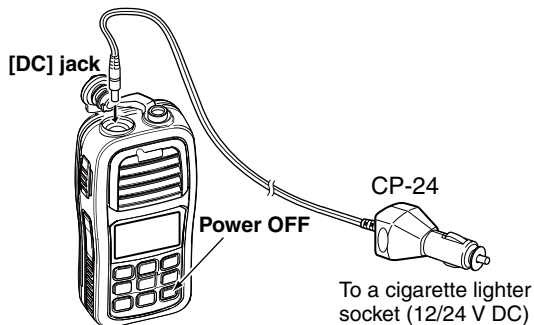

- **CAUTION: BE SURE** to remove the CP-24 from the cigarette lighter socket when charging is finished, because a slight current still flows in the CP-24 and will drain the vehicle's battery.
- The CP-24 is equipped with a 2 A fuse. If the fuse blows, determine and fix the problem, then replace it with a new rated fuse.

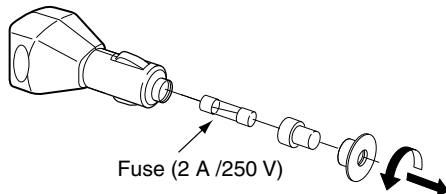

9

TROUBLESHOOTING

PROBLEM	POSSIBLE CAUSE	SOLUTION	REF.
The transceiver does not turn ON.	<ul style="list-style-type: none"> • The battery is exhausted. • The battery pack is not correctly inserted. 	<ul style="list-style-type: none"> • Recharge the battery pack. • Correctly insert the battery pack. 	p. 23 p. 3
No sound from speaker.	<ul style="list-style-type: none"> • The squelch level is too high. • Volume level is too low. • Speaker has been exposed to water. 	<ul style="list-style-type: none"> • Set the squelch level to the threshold level. • Adjust the audio level to a suitable level. • Remove water from the speaker grill. 	p. 10 p. 10 p. 13
Transmitting is impossible, or high power can not be selected.	<ul style="list-style-type: none"> • Some channels are limited to low power or only receive. • The output power is set to low. • The battery is exhausted. 	<ul style="list-style-type: none"> • Change the channel. • Push [Hi/Lo] to select high power. • Recharge the battery pack. 	pp. 8, 9, 27 p. 11 p. 23
The displayed channel cannot be changed.	<ul style="list-style-type: none"> • The Lock function is activated. 	<ul style="list-style-type: none"> • Hold down [] (Hi/Lo) for 1 second to turn OFF the function. 	p. 13
Scan does not start	<ul style="list-style-type: none"> • “TAG” channels are not programmed. 	<ul style="list-style-type: none"> • Set desired channels as “TAG” channels. 	p. 15
No beep sounds.	<ul style="list-style-type: none"> • Beep Tone function is turned OFF. 	<ul style="list-style-type: none"> • Turn ON the Beep Tone in the set mode. 	p. 18

■ Specifications

◇ GENERAL

- Frequency coverage:

Transmitting	156.000–161.450 MHz
Receiving	156.000–163.425 MHz
- Mode: FM (16K0G3E)
- Antenna impedance: 50 Ω (nominal)
- Power supply requirement: BP-266 only
- Current drain (approximate):

TX (5 W/1.0 W/0.5 W)	2.3 A/0.9 A/0.7 A
Maximum audio	0.35 A typical
Power save	8 mA typical
- Frequency stability: ±1.5 kHz
- Operating temperature range: –15°C to +55°C
- Dimensions: 58.5 (W) × 128.5(H) × 34.5(D) mm
(Projections not included)
- Weight: Approximate 260 g
(including battery pack, antenna, belt clip)

◇ TRANSMITTER

- Output power:

5 W (approx.; High)/1 W (Low)/0.5 W (E_Low)*
*1 W (High) and 0.5 W (Low) for German version, depending on the pre-programmed setting
- Modulation system: Variable reactance frequency modulation
- Maximum frequency deviation: ±5 kHz
- Adjacent channel power: 70 dB
- Spurious emissions: 0.25 μW
- Audio harmonic distortion: 10% (at 60% deviation)
- Residual modulation: 40 dB
- Audio frequency response: +1 dB to –3 dB of 6 dB oct. from 300–3000 Hz

◇ RECEIVER

- Receive system: Double-conversion superheterodyne
- Intermediate frequency: 1st 21.7 MHz, 2nd 450 kHz
- Sensitivity (20 dB SINAD): –4 dBμ emf typical
- Squelch sensitivity: –5 dBμ emf typical (at threshold)
- Intermodulation: 68 dB
- Hum and noise: 40 dB
- Audio frequency response: +1 dB to –3 dB of –6 dB oct. from 300–3000 Hz
- Spurious response: 70 dB
- Adjacent channel selectivity: 70 dB
- Audio output power (8 Ω): 0.6 W (at 1 kHz, 10% distortion)

All stated specifications are subject to change without notice or obligation.

■ Options

◇ BATTERY PACK

- **BP-266** Li-ion BATTERY PACK
Voltage: 3.7 V
Capacity: 1500 mAh (minimum), 1590 mAh (typical)

◇ CHARGERS

- **BC-199S** AC ADAPTER
For regular charging of the battery pack.
Charging time: Approximate 8.5 hours
- **BC-119N** DESKTOP CHARGER + **AD-123** CHARGER ADAPTER + **BC-145S** AC ADAPTER
For rapid charging of the battery pack.
The power adapter, BC-145S, is not supplied with some versions.
Charging time: Approximate 2.5 hours
- **BC-121N** MULTI-CHARGER + **AD-123** CHARGER ADAPTER + **BC-157S** AC ADAPTER
For simultaneously rapid charging up to six battery packs (six AD-123s are required). A power adapter must be separately purchased.
Charging time: Approximate 2.5 hours

◇ OTHER OPTIONS

- **FA-SC58V** ANTENNA
- **MB-124** BELT CLIP
- **CP-24** CIGARETTE LIGHTER CABLE
- **CP-23L** CIGARETTE LIGHTER CABLE
For BC-119N
- **OPC-515L** DC POWER CABLE
For BC-119N

Some options may not be available in some countries. Please ask your dealer for details.

Count on us!

< Intended Country of Use >

<input type="checkbox"/> AT	<input type="checkbox"/> BE	<input type="checkbox"/> CY	<input type="checkbox"/> CZ	<input type="checkbox"/> DK	<input type="checkbox"/> EE
<input type="checkbox"/> FI	<input type="checkbox"/> FR	<input type="checkbox"/> DE	<input type="checkbox"/> GR	<input type="checkbox"/> HU	<input type="checkbox"/> IE
<input type="checkbox"/> IT	<input type="checkbox"/> LV	<input type="checkbox"/> LT	<input type="checkbox"/> LU	<input type="checkbox"/> MT	<input type="checkbox"/> NL
<input type="checkbox"/> PL	<input type="checkbox"/> PT	<input type="checkbox"/> SK	<input type="checkbox"/> SI	<input type="checkbox"/> ES	<input type="checkbox"/> SE
<input type="checkbox"/> GB	<input type="checkbox"/> IS	<input type="checkbox"/> LI	<input type="checkbox"/> NO	<input type="checkbox"/> CH	<input type="checkbox"/> BG
<input type="checkbox"/> RO	<input type="checkbox"/> TR	<input type="checkbox"/> HR			

A-6925H-1EX-①

Printed in Japan

© 2011–2016 Icom Inc.

Printed on recycled paper with soy ink.

Icom Inc.

1-1-32 Kamiminami, Hirano-ku, Osaka 547-0003, Japan