

icom

INSTRUCTION MANUAL

VHF MARINE TRANSCEIVER
IC-M127



Icom Inc.

IN CASE OF EMERGENCY

If your vessel requires assistance, contact other vessels and the Coast Guard by sending a distress call on channel 16.

○ USING CHANNEL 16

DISTRESS CALL PROCEDURE

1. "MAYDAY MAYDAY MAYDAY"
2. "THIS IS _____" (name of vessel)
3. Your call sign or other indication of the vessel (AND 9-digit DSC ID if you have one).
4. "LOCATED AT _____" (your position)
5. The nature of the distress and assistance required.
6. Any other information which might facilitate the rescue.

Or, transmit your distress call using digital selective calling on channel 70 (the optional UX-130 DSC UNIT must be installed).

○ USING DIGITAL SELECTIVE CALLING (ch 70) (UX-130 required)

DISTRESS CALL PROCEDURE

1. Push and hold [EMER] for 5 sec. until you hear 5 short beeps change to one long beep.
2. Then, push [PTT] to transmit the call.
3. Wait for an acknowledgment from a coast station.
 - When received, channel 16 is automatically selected.
4. Push and hold [PTT], then transmit the appropriate information as at left.

TABLE OF CONTENTS

IN CASE OF EMERGENCY	i		
TABLE OF CONTENTS	ii		
IMPORTANT	iii		
CAUTIONS	iii		
1 OPERATING RULES	1		
2 PANEL DESCRIPTION	2 – 5		
■ Front panel	2		
■ Function display	4		
3 BASIC OPERATION	6 – 12		
■ Power ON	6		
■ Channel selection	6		
■ Receiving	8		
■ Transmitting	9		
■ Scan function	10		
■ Call channel programming	11		
■ Display backlighting	11		
■ Channel names	12		
4 DIGITAL SELECTIVE CALLING	13 – 20		
■ General	13		
■ Distress call transmission	14		
■ All ships call transmission	15		
■ Individual call transmission	16		
■ Address input mode	17		
■ Receiving DSC calls	18		
5 OTHER FUNCTIONS	21 – 25		
■ Hailer operation	21		
■ Intercom operation	22		
■ Automatic fog horn	24		
■ Internal speaker ON/OFF	25		
■ Displaying position	25		
6 SET MODE	26 – 30		
■ Entering SET mode	26		
■ SET mode items	26		
7 CONNECTIONS AND MAINTENANCE	31 – 37		
■ Unpacking	31		
■ Additional requirements	31		
■ Basic connections	32		
■ Connections for hailer/intercom/fog horn	34		
■ Mounting the transceiver	36		
■ Antenna	37		
■ Fuse replacement	37		
■ Cleaning	37		
8 OPTION INSTALLATION	38		
■ Removing/replacing the case	38		
■ Unit installation	38		
9 TROUBLESHOOTING	39		
10 VHF MARINE CHANNEL LIST	40 – 41		
11 SPECIFICATIONS	42		
12 OPTIONS	43		

IMPORTANT

READ ALL INSTRUCTIONS carefully and completely before using the transceiver.

SAVE THIS INSTRUCTION MANUAL—This instruction manual contains important operating instructions for the IC-M127.

YOU MUST HAVE a DSC vessel ID in order to operate the optional DSC functions of the transceiver. See your Dealer for details.

CAUTIONS

⚠ WARNING NEVER connect the transceiver to an AC outlet. This may pose a fire hazard or result in an electric shock.

⚠ WARNING HIGH VOLTAGE! NEVER touch the antenna or an internal antenna connector during transmission. This may result in an electric shock or a burn.

NEVER connect the transceiver to a power source of more than 16 V DC. This connection will ruin the transceiver.

WHEN INSTALLING THE DSC UNIT

NEVER transmit a distress call when your vessel does not need immediate help. Distress calls can be used only in times of emergency.

AVOID using or placing the transceiver in direct sunlight or in areas with temperatures below -20°C (-4°F) or above $+60^{\circ}\text{C}$ ($+140^{\circ}\text{F}$).

DO NOT operate the transceiver without running the vessel's engine. When your vessel's engine is OFF and the transceiver is transmitting, the vessel's battery will soon become exhausted.

KEEP the transceiver out of the reach of children.

KEEP the transceiver and microphone at least 1 meter away from your vessel's magnetic navigation compass.

◇ Priorities

- Read all rules and regulations pertaining to priorities and keep an up-to-date copy handy. Safety and distress calls take priority over all others.
- You must monitor channel 16 when you are not operating on another channel.
- False or fraudulent distress calls are prohibited under law.

◇ Privacy

- Information overheard but not intended for you cannot lawfully be used in any way.
- Indecent or profane language is prohibited.

◇ Radio licenses

SHIP STATION LICENSE

You must have a current radio station license before using the transceiver. It is unlawful to operate a ship station which is not licensed.

Inquire through your dealer or the appropriate government agency for a Ship-Radiotelephone license. This license includes the call sign which is your craft's identification for radio purposes.

An FCC form 506 may be supplied with the IC-M127 U.S.A. version. In this case, complete the form and send it to the nearest FCC office.

OPERATOR'S LICENSE

A restricted Radiotelephone Operator Permit is the license most often held by small vessel radio operators when a radio is not required for safety purposes.

The Restricted Radiotelephone Operator Permit must be posted near the transceiver or be kept with the operator. Only a licensed radio operator may operate a transceiver.

However, non-licensed individuals may talk over a transceiver if a licensed operator starts, supervises, ends the call and makes the necessary log entries.

A current copy of the applicable government rules and regulations is only required to be on hand for vessels in which a radio telephone is compulsory. However, even if you are not required to have these on hand it is your responsibility to be thoroughly acquainted with all pertinent rules and regulations.

■ Front panel

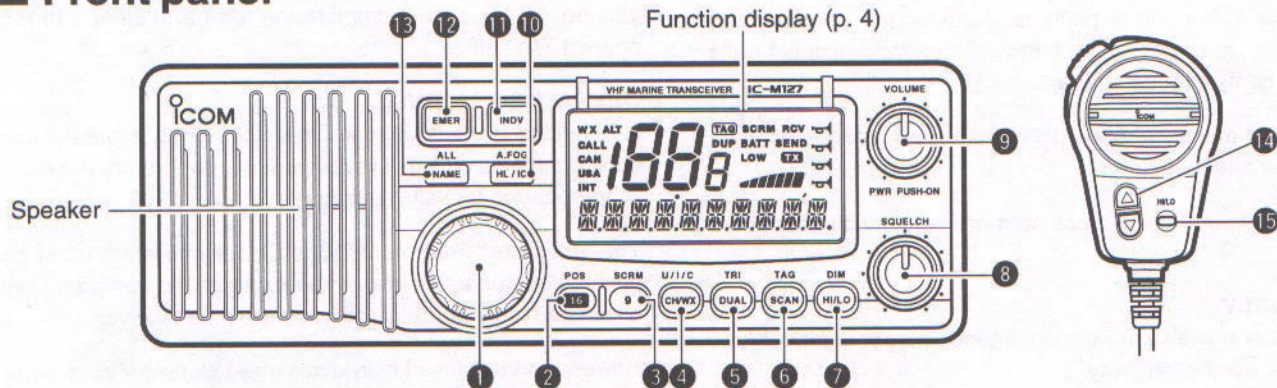

1 CHANNEL SELECTOR [CHANNEL]

Selects an operating channel in the selected channel group.

2 CHANNEL 16 SWITCH [16 • POS]

- Selects channel 16. (p. 6)
- Push for 1 sec. to display your position (when a GPS receiver is connected). (p. 25)

3 CALL CHANNEL SWITCH [9 • SCRM]

- Selects the call channel—the call channel is programmable, channel 9 being the default. (p. 6)
- Push and hold to activate the optional voice scrambler function (optional UT-98 is required). (pgs. 38, 43)

4 CHANNEL/WEATHER CHANNEL SWITCH [CH/WX • U/I/C]

- Toggles between regular and weather channels. (p. 7)
- Selects channel groups in sequence when pushed for 1 sec. (p. 7)

5 DUAL/TRI-WATCH SWITCH [DUAL • TRI] (p. 8)

- Activates dualwatch for checking channel 16.
- Push for 1 sec. to activate tri-watch for checking channel 16 and the call channel.

6 SCAN SWITCH [SCAN • TAG]

- Starts and stops normal or priority scan when tag channels are programmed. (p. 10)

- Push for 1 sec. to toggle the tag setting for the displayed channel. (p. 10)
- 7 HIGH/LOW POWER SWITCH [HI/LO • DIM]**
- Toggles between high and low output powers. (p. 9)
 - While pushing, rotate the channel selector or push the [▼]/[▲] switches on the microphone to adjust the display and control/switch backlighting intensity. (p. 11)
- 8 SQUELCH CONTROL [SQUELCH]**
- Rotate clockwise to eliminate audio noise. (p. 8)
 - Activates the built-in attenuator when rotated deep clockwise. (p.8)
- 9 POWER/VOLUME CONTROL [PWR/VOL] (p. 8)**
- Push to turn power ON/OFF.
 - Rotate to adjust the audio output.
- 10 HAILER/INTERCOM SWITCH [HL/IC • A.FOG]**
- Selects/turns OFF the hailer and intercom functions. (pgs. 21, 22)
 - Push for 5 sec. to activate the auto fog horn function. (p. 24)
- 11 INDIVIDUAL CALL SWITCH [INDV] (p. 16)**
- Push for 5 sec. to enter the individual call standby condition (when optional UX-130 is installed).
- 12 EMERGENCY SWITCH [EMER] (p. 14)**
- Push for 5 sec. to enter the distress call transmission standby condition (when optional UX-130 is installed).
- 13 CHANNEL NAME SWITCH [NAME]**
- Push to enter name input mode. (p. 12)
 - Push for 5 sec. to enter the stand by condition for an "all ships call" (when optional UX-130 is installed). (p. 15)
- 14 CHANNEL UP/DOWN SWITCHES [▼]/[▲]**
- Select an operating channel in the selected channel group.
 - ⇒ These switches can be used instead of the transceiver's channel selector.
- 15 HIGH/LOW POWER SWITCH [HI/LO]**
- The same function as the transceiver's front panel.
- Toggles between high and low output powers. (p. 9)
 - While pushing, rotate the channel selector to adjust the display and control/switch backlighting intensity. (p. 11)

■ Function display

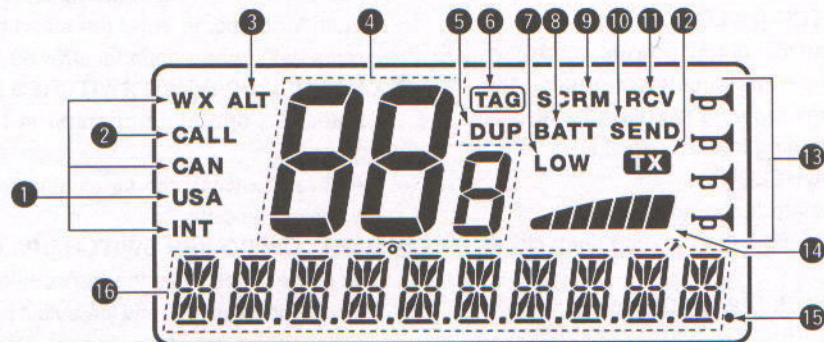

① MODE INDICATORS (p. 7)

- ➔ "USA" shows USA channels are selected.
- ➔ "CAN" shows Canadian channels are selected.
- ➔ "INT" shows International channels are selected.
- ➔ "WX" shows weather channels are selected.

② CALL CHANNEL INDICATOR

Appears when the call channel is selected. (p. 6)

③ WEATHER ALERT INDICATOR

Indicates the weather alert function is activated. (p. 7)

④ CHANNEL INDICATOR

Shows the operating channel. (p. 7)

⑤ DUPLEX INDICATOR

Appears when the selected channel is a duplex channel.

⑥ TAG CHANNEL INDICATOR

Appears when the selected channel is set as a tag channel. (p. 10)

⑦ LOW POWER INDICATOR

Shows that low output power is selected. (p. 9)

8 LOW BATTERY INDICATOR

Appears when the vessel's battery voltage drops below 11 V. (p. 6)

9 VOICE SCRAMBLER INDICATOR

Appears while the optional voice scrambler is activated. (p. 8)

10 SEND INDICATOR

Appears when DSC information has been transmitted. (pgs. 13–20)

11 RECEIVE INDICATOR

Appears when DSC information has been received. (pgs. 13–20)

12 TRANSMIT INDICATOR

Appears while transmitting. (p. 9)

13 AUTO FOG HORN INDICATORS

Appear when the auto fog horn function is activated. The number of indicators varies according to the selected fog horn type. (p. 24)

14 S/RF INDICATOR

- Shows the relative signal strength while receiving.
- Shows whether high or low output power is selected while transmitting. (pgs. 8, 9)

15 NMEA INDICATOR

Appears when NMEA devices (such as a GPS receiver) are connected. (p. 35)

16 ALPHANUMERIC READOUT

- Displays channel names during regular operation. (p. 12)
- Displays position and UTC time when [16 •POS] is pushed for 1 sec. (p. 25)
- Displays selected functions, DSC information, set mode items, etc. depending on operation.

■ Power ON

- ① Push [PWR] in to turn power ON.



All display indications appear briefly*.

*SCRM appears only when an optional UT-98 is installed.

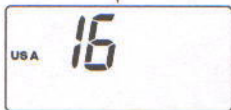

- ② Operate the transceiver as indicated in the following sections.

◇ Low voltage indicator

When "BATT" appears and flashes as shown at right, the vessel's battery voltage has dropped below 11 V, indicating there is a DC power source problem. In this case, check your vessel's battery and DC power cable.



■ Channel selection

◇ Channel 16

Channel 16 is the distress channel. It is used for establishing initial contact with another station and for emergency communications. Channel 16 is monitored during dualwatch/tri-watch. While standing by you are required to monitor channel 16.

Push



◇ Call channel

The call channel is used to store your most often-used channel for quick recall. In addition, the call channel is monitored during tri-watch. The default setting for the call channel is channel 9, which is for pleasure boat use.

Push



"CALL" indicates that the call channel is selected.

◇ U.S.A., Canadian and international channels

There are 63 U.S.A., 62 Canadian and 59 international channels. These channel groups may be specified for the operating area.

- ① Push [CH/WX] to select a regular channel.
 - If a weather channel appears, push [CH/WX] again.
- ② Rotate the channel selector to select a channel.
 - “DUP” appears for duplex channels.
- ③ To change the channel group, push [CH/WX • U/I/C] for 1 sec.
 - U.S.A., Canadian and international channels can be selected in sequence.



NOTE: When “DUP” appears in the display the selected channel is a *duplex channel*. Duplex channels are used for ship-to-coast communications. When “DUP” does not appear in the display, the selected channel is a *simplex channel*. Simplex channels are used for ship-to-ship communications.

◇ Weather channels

There are 10 weather channels. These are used for monitoring NOAA (National Oceanographic and Atmospheric Administration) weather broadcasts.

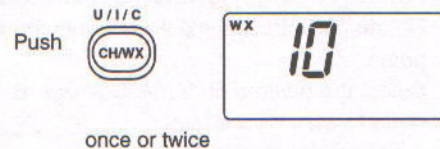

✓ CONVENIENT

Weather alert function: NOAA broadcast stations transmit a weather alert tone before important weather announcements.

When the weather alert function is turned ON (in SET mode), and the IC-M127 receives an alert tone, the “ALT” indicator flashes until any key is pushed.

This function can only be activated when a weather channel is selected or during any scan (if the scan includes weather channels). See “SET mode items” on p. 28.

3 BASIC OPERATION

■ Receiving

- ① Push [PWR] to turn power ON.
- ② Rotate [SQUELCH] fully counterclockwise.
- ③ Rotate [VOLUME] to obtain a suitable listening level.
- ④ Rotate [SQUELCH] clockwise until the audio noise disappears.
- ⑤ Select the desired channel. See pgs. 6–7 for details.
 - When a signal is received:
 - The squelch opens;
 - Audio is emitted from the speaker;
 - The S/RF indicator shows the received signal strength.
- ⑥ When an interrupting signal is received; rotate [SQUELCH] deeply clockwise.



◇ Voice scrambler function

For confidential communications, use the optional voice scrambler function. All members of your group must have the UT-98 VOICE SCRAMBLER UNIT installed in order to communicate using this function.

- ➔ Push [9 • SCRM] for 1 sec. to toggle the function ON and OFF.
 - "SCRM" appears when the function is ON.
 - This function cannot be used on CH 16.
 - Set the scramble code in SET mode in advance (p. 30).



◇ Dual/tri-watch functions

These functions allow you to conveniently check the distress channel (ch 16) or, both the distress and call channel (ch 9; programmable) while receiving another channel. When receiving a signal on one of these channels, the transceiver stops on the channel until the signal disappears.

- ➔ Push [DUAL • TRI] momentarily for dualwatch.



Checking channel 16 every 2 sec.

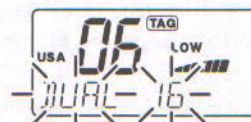

Signals on channel 16 are monitored until they disappear.

- ➔ Push and hold [DUAL • TRI] for tri-watch.



Checking channel 16 and the call channel every 2 sec.



When receiving a signal on the channel, the call channel is monitored while checking ch 16

Signals received on channel 16 have priority.



■ Transmitting

Before transmitting, read the call procedures at right.

- ① Select an operating channel. See pgs. 6, 7 for details.
- ② Push [HI/LO] to select transmit output power.
 - "LOW" appears when low output power is selected.
 - High power cannot be selected on some channels. Refer to the channel list on pgs. 40, 41.
- ③ Push and hold the PTT switch to transmit.
 - "TX" appears.
- ④ Speak into the microphone at your normal voice level.
 - Do not hold the microphone too closely to your mouth or speak too loudly. This may distort the transmit signal.
- ⑤ Release the PTT switch to receive.

IMPORTANT: In order to maximize the readability of your transmitted signal, pause for a moment after pushing [PTT], hold the microphone 15–20 cm from your mouth, then speak into the microphone at an even, normal voice level.

CALL PROCEDURES

You must identify yourself when you transmit and you must respect time limits.

- 1) Give your call sign each time you call another vessel or a coast station. If you have no call sign, identify the station by giving the vessel name and the name of the license.
- 2) Give your call sign at the end of each transmission that lasts more than 3 minutes.
- 3) You must pause and give your call sign at least once every 15 minutes during long ship-to-shore calls.
- 4) Keep your calls short (less than 3 minutes). Wait 2 minutes before repeating a call.
- 5) Unnecessary transmissions are not allowed.

MOMENTARY HIGH POWER

On U.S.A. channels 13, 15 and 67, transmission using high power is momentarily possible. To use high power, push and hold [HI/LO] while transmitting.

TIME-OUT TIMER (U.S.A. version only)

The transceiver has a time-out timer function to prevent continuous, long transmissions. Transmit is automatically inhibited after 5 min. of continuous transmission.

3 BASIC OPERATION

■ Scan function

The transceiver has a high speed scan function for standing by on utility signals. The scan speed is 8 channels/sec. (except when the weather alert function is in use).

Two scan types are available: *normal scan* (scans all tag channels in sequence) and *priority scan* (checks channel 16 while scanning and becomes dual watch while pausing on a regular channel—except for channel 16). These scans can be selected in SET mode (p. 28).

◇ Setting tag channels

You can specify channels as tag channels for efficient scanning. Tag channels can be set for each channel group (USA, CAN, INT) independently.

- ➔ Select the desired channel, then push and hold [SCAN • TAG] for 1 sec. to toggle the tag setting.

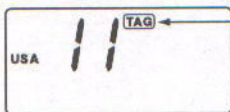

Appears when the channel is specified as a tag channel.

✓ Clearing all tag channels:

While pushing [HI/LO], push and hold [SCAN • TAG] for 3 sec. until the long beep becomes 2 short beeps.

- All tag channels in the selected channel group are released.

◇ Scan operation

- ① Select the desired channel group (USA, CAN, INT) with [CH/WX • U/I/C].
 - When the weather alert function is in use, select the desired WX channel in the display, then perform the above operation.
- ② Push [SCAN] to start scanning.
 - “N--SCAN” appears when normal scan is selected in SET mode.
 - “P--SCAN” appears when priority scan is selected in SET mode.
- ③ To stop the scan, push [SCAN] again.
 - “N--SCAN” or “P--SCAN” disappears.

✓ Scan resume timer:

When a signal is detected, scan pauses until the signal disappears or resumes after pausing 5 sec., according to the SET mode setting. (p. 28)

✓ Confirming tag channels:

While operating scan, rotate [DIAL].

- Only tag channels are selected.
- Stop rotating [DIAL] to resume normal scan operation.

✓ Weather alert function:

When this function is turned ON (p. 28), any weather channels set as tag channels are monitored for alert tones during scan. Refer to p. 7 for a description of weather alert.

■ Call channel programming

The call channel switch, [9], is used to select channel 9, however, you can program your most often-used channels in each channel group for quick recall.

- ① Push [CH/WX • U/I/C] for 1 sec. one or more times to select the desired channel group (USA, INT, CAN) to be programmed.
- ② Push [9] to select the call channel of the selected channel group.
 - "CALL" and the call channel number appear.
- ③ While pushing [HI/LO] push [9] to enter call channel write mode.
 - Call channel number and channel group to be programmed flash.
- ④ Rotate the channel selector to select the desired channel.

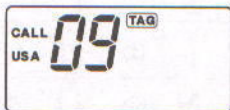
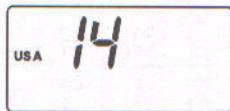

- ⑤ Push [9] again to program the displayed channel as the call channel.
 - The call channel number and channel group stop flashing.



■ Display backlighting

The function display and switches can be backlit for better visibility under low light conditions.

While pushing [HI/LO • DIM], rotate the channel selector or use [UP]/[DN] switches on the microphone to adjust the backlighting.

➤ Backlighting can be set to 1 of 7 intensities or turned OFF.



Backlighting set to brightest



Backlighting turned OFF

3 BASIC OPERATION

■ Channel names

When shipped from the factory, the IC-M127 is programmed with default names for each VHF marine channel (refer to the *VHF MARINE CHANNEL LIST* on pgs. 40, 41). These defaults can be overwritten if desired.

- ① Rotate [CHANNEL] to select a channel to program.



- ② Push [NAME] momentarily.
• The 1st character of the currently programmed name flashes.



- ③ Rotate channel to select a character.



- ④ Push [HI/LO] to move to the right; then rotate [CHANNEL] to select the next character.
• Pushing [SCAN] moves to the left.



- ⑤ Continue until the desired characters have been selected, then push [NAME] to return to normal operation.



Available characters

= (=)	+ (+)	-- (hyphen)	* (*)	/ (/)
, (.)	(space)	0 (0)	1 (1)	2 (2)
3 (3)	4 (4)	5 (5)	6 (6)	7 (7)
8 (8)	9 (9)	A (A)	B (B)	C (C)
D (D)	E (E)	F (F)	G (G)	H (H)
I (I)	J (J)	K (K)	L (L)	M (M)
N (N)	O (O)	P (P)	Q (Q)	R (R)
S (S)	T (T)	U (U)	V (V)	W (W)
X (X)	Y (Y)	Z (Z)	a (a)	b (b)
c (c)	d (d)	e (e)	f (f)	g (g)
h (h)	i (i)	j (j)	k (k)	l (l)
m (m)	n (n)	o (o)	p (p)	q (q)
r (r)	s (s)	t (t)	u (u)	v (v)
w (w)	x (x)	y (y)	z (z)	

■ General

When an optional UX-130 DSC UNIT is installed, digital selective calling (or DSC) can be used via the transceiver. DSC is a method of radio communications involving digital signals rather than the more conventional method of voice communications. The advantage of using digital communications over voice communications is that information (especially useful for distress calls and other urgent matters) can be pre-programmed into a radio and transmitted accurately.

In addition, when a GPS receiver (NMEA0183 ver. 1.5, 2.0 or 2.1) is connected, your vessel's position is transmitted together with the vessel's identity when making a distress call.

See p. 38 for unit installation.

DSC TYPE	DESCRIPTION	REF.
Distress call	This sends distress information which includes your vessel's ID (and position/UTC time data when a GPS receiver is connected). Send under <i>emergency conditions only</i> . DSC acknowledgement will be received from a coast station after making a distress call.	pgs. 14, 18
Distress relay call	This is used to alert Coast stations (or other ships) when a vessel in distress is unable to do so. The IC-M127 can <i>only receive</i> this type of signal; not transmit.	p. 18
All ships call	This is used for non-emergency situations. This signal includes information which allows a receiving transceiver to automatically select a specified channel for voice communication.	pgs. 15, 18
Individual call	This allows you to send a signal to a specific vessel only. The transceiver can store up to 10 destination ID channels—select the desired ID in advance. Two kinds of acknowledgements (able to comply/unable to comply) are available (for sending or receiving) after an individual call.	pgs. 16, 19
Geographical area call	This is used for announcement to all ships in the specified area—when a GPS receiver is connected calls directed to areas other than yours are rejected. <i>Receive only</i> for the IC-M127.	p. 19

■ Distress call transmission

CAUTION: Distress calls may be transmitted under conditions of emergency only i.e. your vessel is in danger of sinking and/or a person's life is in danger.

- ① Push and hold [EMER] until you hear 4 short beeps change to one long beep.
 - The display changes as at right.
- ② Push [PTT] to transmit the distress call.



- ③ The transceiver remains on channel 70 until an acknowledgement is received.
 - When no acknowledgement is received, the distress call is repeated until an acknowledgement is received.
 - To cancel this, turn power OFF then ON again.
 - Calls to you other than distress acknowledgement cannot be received.

- ④ When a distress acknowledgement is received, emergency alarm sounds and channel 16 is automatically selected.
 - Push any key to cancel the alarm.



- ⑤ Transmit your distress call particulars by voice using the following procedure:

1. "MAYDAY."
2. "THIS IS (name of your vessel)."
3. The 9-digit identity AND the call sign (or other vessel identification).
4. Your vessel's position if DSC does not include it.
5. The nature of the distress and assistance required.
6. Any other information which might facilitate the rescue.

NOTE: When a GPS receiver (NMEA 0183) is connected, your vessel's position is automatically transmitted with the distress call.

NOTE: Acknowledgement of a DSC distress alert is normally made by coast stations only.

■ All ships call transmission

Large ships use channel 70 as their “listening channel.” When you want to announce a message to these ships, use the “all ships call” function.

- ① Select a simplex channel for the traffic channel (for voice communication after sending the all ships call).



- Some 'A' channels (eg. channel 88A) cannot be used.

- ② Rotate [SQUELCH] clockwise until the audio noise disappears.

- ③ Push and hold [NAME • ALL] until you hear 4 short beeps change to one long beep.



- The display changes as at right.



- ④ Push [PTT] momentarily to transmit the all ships call.

- After transmission, the channel set in step ① above is selected.



- ⑤ Push and hold [PTT] again to send an announcement to all ships.



NOTE: Channel busy

When channel 70 is busy, the all ships call is not transmitted. The transceiver waits until the channel is clear, then transmits the call automatically.



This display appears while the call is in standby.

NOTE: Error indication

When a transmission inhibited channel (e.g. ch 70) is selected for the traffic channel, the display at right appears. In this case, an appropriate channel must be selected.



Individual call transmission

The individual call function allows you to transmit a DSC signal to a specific party only.

- ① Set the ID code for the individual you wish to call in advance (see p. 17).
- ② Select the traffic channel (for voice communication after the individual call is sent).
 - Select a simplex channel (some 'A' channels cannot be used) for ship-to-ship contact.
 - Select a duplex channel for ship-to-coast contact.
- ③ Rotate [SQUELCH] clockwise until the audio noise disappears.
- ④ While pushing [INDV], rotate the channel selector to select the desired pre-programmed individual address.
- ⑤ Continue pushing and holding [INDV] until you hear 4 short beeps change to one long beep.
 - The display changes as at right.
- ⑥ Push [PTT] momentarily to transmit the individual call.
 - "HIGH" power is automatically selected while transmitting the call.



- ⑦ Standby on channel 70 until an acknowledgement is received.
- ⑧ When the acknowledgement is received, the display changes as at right.
 - Beeps sound.
 - The channel set in step ② is selected.
- ⑨ Push and hold [PTT] to communicate your message to the responding party.



NOTE: *Unable to comply*
When the received acknowledgement includes "unable to comply," the message display changes as at right. In such a case, wait at least 5 min. before re-transmitting the call.



NOTE: *Channel busy error indication*
The same as for the all ships call. Refer to the previous page for details.

■ Address input mode

In order to place individual calls you must know the 10-digit address code of the vessel you wish to communicate with. The IC-M127 can be programmed with up to 10 separate address codes. When transmitting an individual call (p. 16) the address code last programmed is used. If no address codes have been programmed, the individual call function will not work.

- ① While pushing [9] and [CH/WX], push [PWR] IN to turn power ON.
- "INDV ADRS" appears for 1 sec. and address input mode is selected.

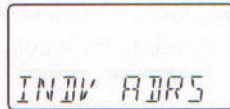

- ② Rotate the channel selector to select the address number to be programmed, "Ad0" to "Ad9."



- "- -" appear instead of numbers when an address code is not yet programmed.
- ③ Push [16] to initiate code input, then rotate the channel selector to select a number for the 1st digit.
- If a "- -" is selected as one of the digits, the address is invalid.



- ④ Push [HI/LO] to move to the next digit, then rotate the channel selector to select a number.
- Pushing [SCAN] moves to the left (previous) digit.
 - If a mistake is made, push [16] and repeat from step ③.



- ⑤ To input a name to the set address, push [NAME], then set the desired name with the channel selector.
- Use [HI/LO] and [SCAN] keys to move the cursor.



- ⑥ Push [NAME] again to memorize the name.



- ⑦ Turn power OFF, then ON again to exit the address input mode.

■ Receiving DSC calls

Several types of DSC transmissions can be received. The required action depends on the particular DSC type as outlined in the following examples. However, in all examples, you must be monitoring channel 70 in order to receive such signals.

NOTE: When channel 70 is set as a tag channel and scan is functioning, DSC calls will not be received. DSC calls can only be received when channel 70 is selected.

◇ Receiving a distress call

While monitoring channel 70 and a distress call is received:

- ➔ Emergency alarm sounds.
- ➔ "RCV" and "DISTRESS" appear in the display; then, channel 16 is automatically selected.
- ➔ Push [16] to stop the alarm.
- ➔ Continue monitoring channel 16 as a coast station may require assistance in any rescue attempt.

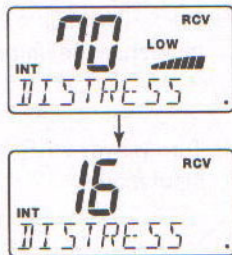

◇ Receiving a distress relay call

A distress relay call may be transmitted from a large ship to a coast station. While monitoring channel 70 and a distress relay call is received:

- ➔ Emergency alarm sounds.
- ➔ "RCV" and "DTRS RELAY" appear in the display; then, channel 16 is automatically selected.
- ➔ Push [16] to stop the alarm.
- ➔ Monitor channel 16 until the emergency communication has been completed.



◇ Receiving an all ships call

While monitoring channel 70 and an all ships call is received:

- ➔ Emergency alarm or beeps sound depending on the received category.
- ➔ "RCV" and "ALL SHIPS" appear in the display; then, the channel specified by the calling station is automatically selected for voice.
- ➔ Monitor the selected channel for an announcement from the calling vessel.

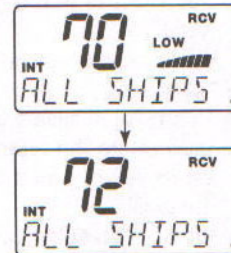

◇ Receiving a geographical area call

While monitoring channel 70 and a geographical area call (for the area you are in) is received:

- Emergency alarm or beeps sound depending on the received category.
- "RCV" and "GEOGRAPHIC" appear in the display; then, the channel specified by the calling station is automatically selected for voice communications.
- Monitor the selected channel for an announcement from the calling ship.

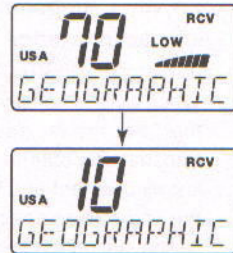

/// **NOTE:** When no GPS receiver is connected or if there is a problem with the connected receiver, all geographical area calls are received, regardless of your position.

◇ Receiving an individual call

When receiving an individual call, an acknowledgement must be sent back to the calling station within 4.5 min. Operation and transceiver function differs depending on the SET mode settings.

Two messages can be selected for acknowledgement:

- "Able to comply".....You can communicate with the calling vessel via the mic after a DSC connection.
- "Unable to comply".....You cannot communicate with the calling vessel after a DSC connection (e.g. operator leaves transceiver).

While monitoring channel 70 and an individual call is received:

- Emergency alarm or beeps sound depending on the received category.
- "RCV" and "INDIVIDUAL" appear in the display.
- The channel specified by the calling station is automatically selected for checking the channel condition (except when full automatic acknowledgement is selected).
- Proceed as follows on the next page according to your preset conditions.



4 DIGITAL SELECTIVE CALLING

• When semi-automatic (SA; default) or manual (SL) is selected in SET mode (p. 30):

① Push and hold [INDV] until you hear 4 short beeps change into one long beep to send an "Able to comply" message.

• If you want to send an "Unable to comply" message, or other individual call, rotate the channel selector to select them.

② Push [PTT] momentarily to transmit the acknowledgement.

• The channel specified by the calling station is selected.

• When "Unable to comply" is transmitted in step ①, the transceiver remains on channel 70.

③ After receiving a voice transmission, reply via the mic.



• When full automatic (FA) is selected in SET mode (p. 30):

➤ The transceiver automatically replies to the call in one of two ways, depending on the auto acknowledge setting in SET mode (p. 30).

• When able to comply is set (Ab), the transceiver automatically transmits an able to comply acknowledgement and then selects the channel as specified by the calling station for voice communications.

• When unable to comply is set (Un), the transceiver automatically transmits an unable to comply acknowledgement and remains on channel 70.



Differences between semi-automatic and manual



Semi-automatic: When no operation is performed, the transceiver automatically sends an "Unable to comply" acknowl-

edgement 4.5 min. after the call is received.

Manual: When no operation is performed after receiving a call, NO acknowledgement is transmitted.

■ Hailer operation

The IC-M127 has a 2-way hailer function for voice amplification and reception over the loudspeaker, making it unnecessary to leave the bridge to hear a hailing party.

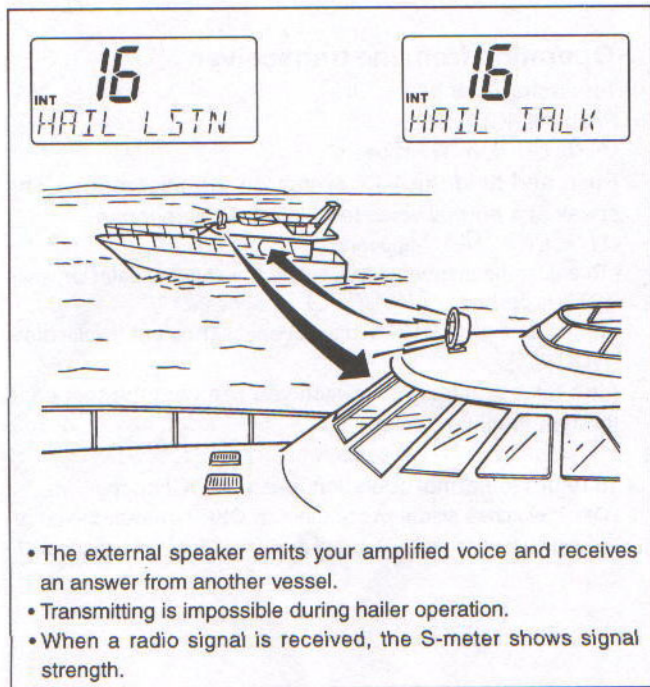

◇ Preparation

- ① Connect an external speaker as illustrated on p. 32.
- ② When you need to have more power (up to 20 W), connect an optional UA-4 AUDIO AMPLIFIER. (p. 35)

◇ Operation

- ① Turn the transceiver power ON.
 - The UA-4 is turned ON automatically if connected.
- ② Push [HL/IC] once.
 - "HAIL LSTN" appears.
- ③ Push and hold the PTT switch on the microphone and speak at a normal voice level into the microphone.
 - "HAIL TALK" appears.
 - To adjust the hailer level, rotate the channel selector while [PTT] is pushed—"HAIL LVL" appears.
- ④ After releasing the PTT switch you can hear the response through the hailer speaker.
 - "HAIL LSTN" appears.
- ⑤ To return to normal operation, push [HL/IC] twice.
 - Other switches also turn the function OFF, however, the corresponding function activates e.g. pushing [16] selects channel 16.

■ Intercom operation

The intercom function allows you to talk to the deck from the cabin. When you do not require the hailer function, you can use 2 separate intercoms.

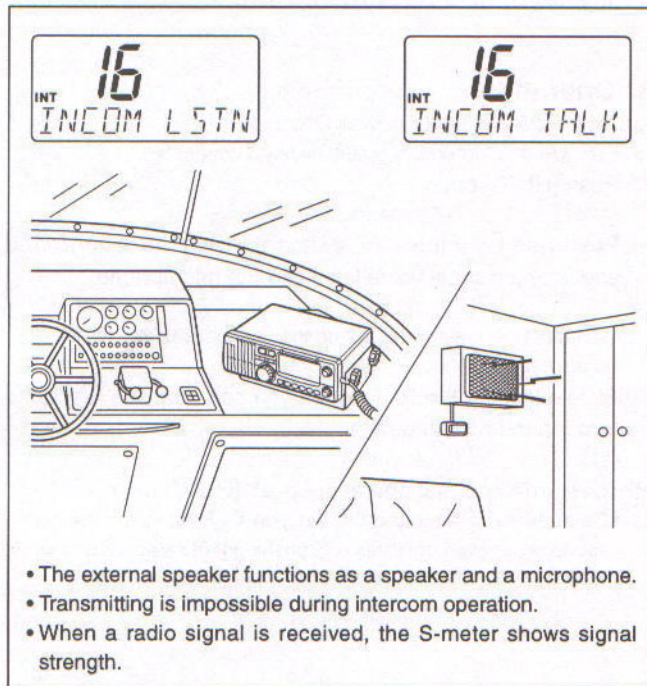

◇ Preparation

Connect an external speaker and an intercom switch as illustrated on p. 34.

◇ Operation from the transceiver

- ① Turn transceiver power ON.
- ② Push [HL/IC] twice.
 - "INCOM LSTN" appears.
- ③ Push and hold the PTT switch on the microphone and speak at a normal voice level into the microphone.
 - "INCOM TALK" appears.
 - To adjust the intercom level, rotate the channel selector while [PTT] is pushed—"INCOM LVL" appears.
 - To adjust the IC-M127's internal speaker output level, rotate [VOLUME].
- ④ After releasing the PTT switch you can hear the response through the intercom speaker.
 - "INCOM LSTN" appears.
- ⑤ To return to normal operation, push [HL/IC] once.
 - Other switches also turn the function OFF, however, the corresponding function activates e.g. pushing [16] selects channel 16.

◇ Operation from the intercom speaker

- ① Push and hold the intercom switch and speak into the speaker.
- ② Keep pushing the intercom switch to receive an answer.
- ③ Release the intercom switch to return the transceiver to cabin control of the intercom switch.

NOTE: While the intercom switch is pushed, the transceiver display appears as below. Transceiver functions (transmit and receive) are interrupted when the external intercom switch is turned ON. If the transceiver is transmitting, the intercom function is not available.



◇ Operation with 2 separate intercoms

When you connect 2 intercom switches and 2 intercom speakers to the transceiver, you can talk to two separate places such as the deck and the fly bridge.

Connect the switches and speakers as illustrated on p. 34 before operating with 2 speakers.

To output from intercom-1 speaker

- ① Push [HL/IC] once or twice to turn the intercom ON.
- ② Push and hold the PTT switch and speak into the mic.

To output from intercom-2 speaker

- ① Push [HL/IC] once or twice to turn the hailer ON.
- ② Push and hold the PTT switch and speak into the mic.

When speaking from the intercom speakers

Push and hold intercom switch 1 or 2, then speak into the speaker as described at left.



Speak into intercom-1 speaker



Speak into intercom-2 speaker





NOTE: The hailer function CANNOT be used when you connect 2 intercom speakers.

5 OTHER FUNCTIONS

■ Automatic fog horn

The automatic fog horn function sounds a horn repeatedly until the function is turned OFF. Four horn patterns are available for varying conditions.

The fog horn outputs from the hailer speaker. To use this function, the hailer speaker must be connected to the transceiver. See pgs. 32 and 34 for connection details.

TYPE	DISPLAY	PATTERN	USAGE
1		One 5-second blast every 100 seconds.	Motor vessel underway and making way.
2		Two 5-second blasts (separated by 2 seconds) every 100 seconds.	Motor vessel underway but stopped (not making way).
3		One 5-second blast followed by two 1-second blasts (each separated by 2 seconds) every 100 seconds.	Sailing vessel underway, fishing vessel (underway or anchored), vessel not under command, a vessel restricted in her ability to maneuver (underway or at anchor), or a vessel towing or pushing another ahead.
4		One 5-second blast followed by three 1-second blasts (each separated by 2 seconds) every 100 seconds.	Vessel under tow (manned).

/// The audio frequency of the fog horn is selectable. See p. 29 for details on selecting the audio frequency.

◇ Turning the auto fog horn ON and OFF

- ① Push [HL/IC • A.FOG] for 1 sec.
 - One or more "📡" appear indicating the selected fog horn pattern.
- ② Push [HL/IC • A.FOG] for 1 sec. again to turn the function OFF.
 - "📡" indications disappear.

◇ Selecting a fog horn pattern

- ① Be sure the fog horn pattern is turned OFF.
 - When turned ON (one or more "📡" appear), push and hold [HL/IC • A.FOG] to turn the function OFF.
- ② Push and hold [HL/IC • A.FOG] until step ③ is finished.
- ③ After "📡" (one or more) appears, rotate the channel selector or microphone [UP]/[DN] switches until the desired fog horn pattern is selected.
 - The number of "📡" appearing indicates the selected fog horn pattern (see page opposite).
 - At this time you can send a fog horn signal manually by pushing [PTT].

■ Internal speaker ON/OFF

When you connect an external speaker and the transceiver's internal speaker is not required, the internal speaker can be deactivated. The internal speaker is turned ON and OFF in SET mode. For details see p. 29.

/// **NOTE:** Even when the internal speaker is set to OFF, optional DSC function alerts will sound when activated.

■ Displaying position

When the optional OPC-457 (NMEA CABLE) and a GPS receiver is connected to the transceiver, your position can be displayed at the push of a switch.

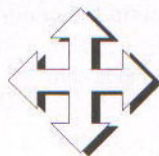

Push [16 • POS] for 1 sec. to display your current vessel position.

■ Entering SET mode

SET mode is used to customize operation of the transceiver to suit your operating needs.

◇ To enter set mode:

- ① While pushing [16], turn power ON.
 - SET mode is selected.
- ② To exit SET mode, turn power OFF then ON again.

◇ To select an item:

There are up to 10 items in SET mode (depending on options installed) that may be adjusted to suit your operating preferences.

- ① Select SET mode as above.
- ② Push [16] to select the desired item; then rotate the channel selector to select the desired condition.
 - See the following pages for details on each SET mode item.

■ SET mode items

This diagram shows the default settings for each SET mode item and the order of selection. Items inside dotted lines only appear when optional units are installed.

03
BEEP LEVEL

Beep tone level (p. 27)

n-
SCAN TYPE

Scan type (p. 28)

0n
SCAN TIMER

Scan timer (p. 28)

0n
WX ALERT

Weather alert function (p. 28)

16

07
ATTENUATOR

RF attenuator ON/OFF (p. 29)

07
INT SP

Internal speaker ON/OFF (p. 29)

85
AUTO FOG H

Auto fog horn frequency (p. 29)

127
SCRAMBLER

Scrambler code (p. 30)

UT-98



FA
ACK

Acknowledgement
method (p. 30)

Ab
AUTO ACK

Auto acknowledgement
contents (p. 30)

UX-130

Back to "BEEP
LEVEL"



◇ Beep tone level

The audio level of the beep tones (emitted when a switch/key is pushed, etc.) can be adjusted from OFF to 3 (loudest).



03
BEEP LEVEL



02
BEEP LEVEL

01
BEEP LEVEL

of
BEEP LEVEL

Beep tones are turned OFF

6 SET MODE

◇ Scan type

Depending on your preference, you can select scans to function as *normal scan* or *priority scan*. See p. 10 for scan details.

Normal scan: all tag channels are checked in sequence.

Priority scan: same as normal scan except that channel 16 is monitored between tag channels.

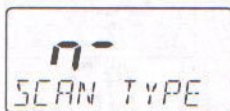

Normal scan is set



Priority scan is set

◇ Scan timer

This item sets the scan behavior when receiving a signal. When set to OFF, scan pauses on a signal until it disappears, then resumes 3 sec. after that; when set to ON, scan resumes 5 sec. after receiving a signal, regardless of whether it disappears or not.



Scan timer is turned ON



Scan timer is turned OFF

◇ Weather alert

This item turns the weather alert function ON and OFF. When the transceiver is scanning or watching a weather channel and a weather alert tone is broadcast, an alert beep sounds (and "ALT" flashes) indicating that an emergency weather report is on the air.



Weather alert function is turned ON



Weather alert function is turned OFF

◇ RF attenuator

This item turns the RF attenuator function ON and OFF. The RF attenuator is activated when rotating [SQUELCH] deep clockwise and is useful when strong adjacent signals alternately open and close the squelch.



ON: rotating [SQUELCH] deep clockwise activates the RF attenuator



OFF: RF attenuator cannot be activated.

◇ Internal speaker ON/OFF

When you connect an external speaker and the transceiver's internal speaker is not required, the internal speaker can be deactivated. Note that DSC alert's will not be turned OFF even when this item is set to OFF.



ON: audio is emitted from the IC-M127's internal speaker

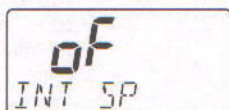

OFF: audio is emitted from a connected external speaker

◇ Auto fog horn frequency

The audio frequency of the auto fog horn can be adjusted to suit your preference. While this item is selected, pushing [PTT] outputs the fog horn—experiment with the frequencies available until you find one you like.

- The horn outputs from the hailer speaker.



850 Hz

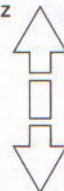

50 Hz
steps



200 Hz

6 SET MODE

◇ Voice scrambler code

This item appears only when an optional UT-98 VOICE SCRAMBLER UNIT is installed.

When communicating using the voice scrambler function, remember that all members of your group must have the scrambler function ON, and the same scramble code set.



Code set to '127'



Code set to '0'

◇ DSC acknowledgement method

This item appears only when an optional UX-130 DSC UNIT is installed.

This item sets the acknowledgment method for replies to a calling station when receiving an individual call (see pgs.13, 16, 19 and 20 for details concerning individual calls).



Full auto: transceiver automatically replies to DSC calls



Semi auto: you must manually reply; however, when no operation is performed, an "unable to comply" is automatically sent



Manual: you must manually reply to calls

◇ Auto acknowledge contents

This item appears only when an optional UX-130 DSC UNIT is installed and full automatic (FA) is selected (see left).

This item only appears when full automatic (FA) is selected in the previous item and sets "unable to comply" or "able to comply" as the full automatic acknowledgement transmission (left).



"Able to comply" message is sent when receiving an individual call



"Unable to comply" message is sent when receiving an individual call

■ Unpacking

① Mounting bracket	1
② DC power cable	1
③ Microphone hanger	1
④ Mounting bolts (M6 × 50)	4
⑤ Mounting screws (A0 6 × 30)	4
⑥ Mic hanger screws (A0 3.5 × 30)	2
⑦ Flat washers (M6)	8
⑧ Spring washers (M6)	4
⑨ Nuts (M6)	4
⑩ Mounting knobs (M6 × 50 SUS)	4
⑪ Fuse (10 A)	1
⑫ ACC connector plug (8-pin)	1

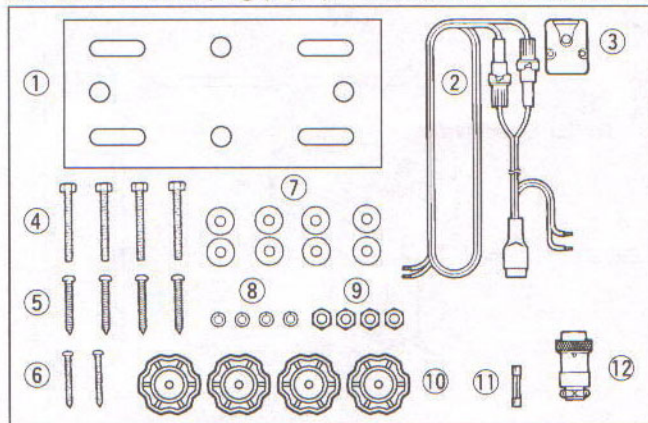

■ Additional requirements

◇ FOR GENERAL OPERATION

- Marine VHF antenna
- Coaxial cable

◇ FOR DSC OPERATION

- UX-130 DSC UNIT

◇ FOR ENHANCED DSC OPERATION

- GPS receiver with NMEA0183 output for sending positioning data.

◇ FOR VOICE SCRAMBLER OPERATION

- UT-98 VOICE SCRAMBLER UNIT

Consult with your dealer if you need this function—disassembly and soldering of transceiver circuits is required for installation.

◇ FOR HAILER OPERATION

- External speaker
- UA-4 AUDIO AMPLIFIER if your require 20 W of output power

◇ FOR INTERCOM OPERATION

- External speaker
- Non-locking switch for intercom operation

Basic connections

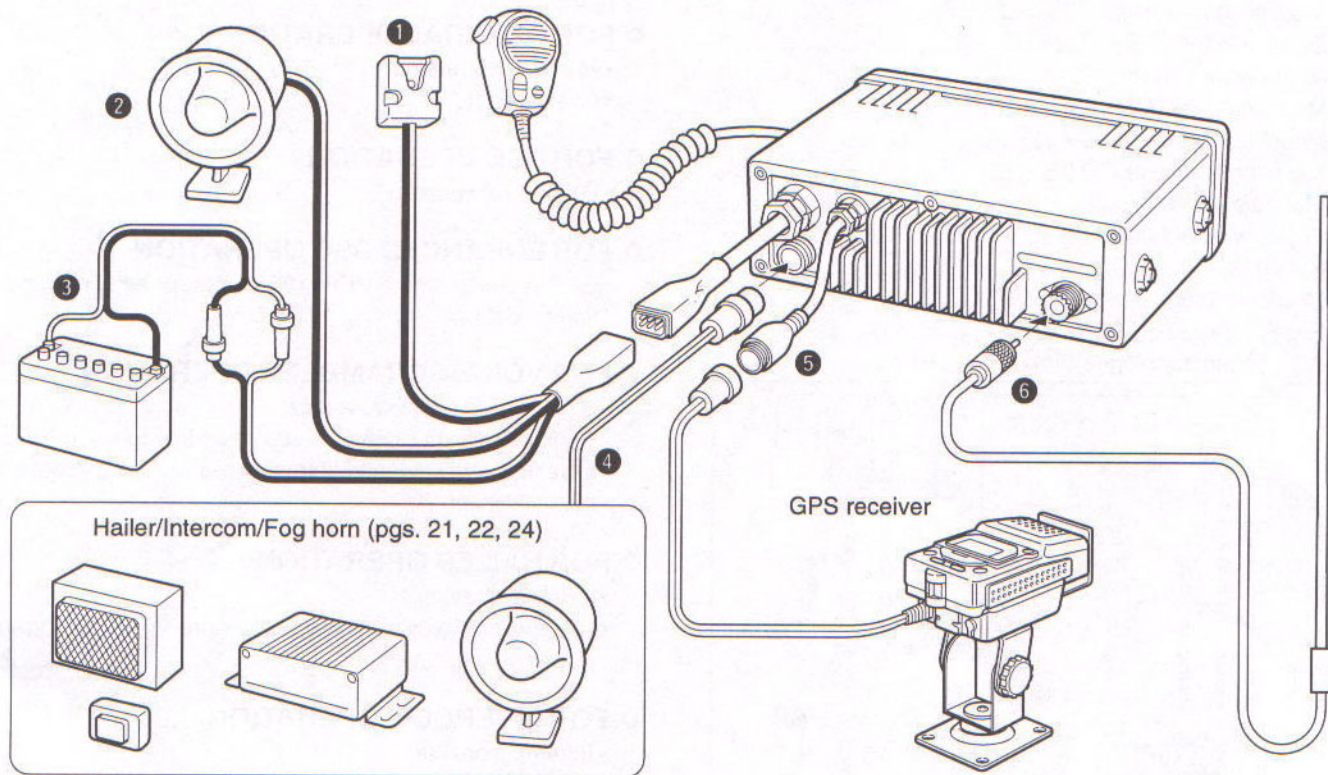

1 MICROPHONE HANGER
2 EXTERNAL SPEAKER CABLES

Set the internal speaker to OFF in SET mode (p. 29).

3 DC POWER CONNECTOR

Connects the supplied DC power cable from this connector to an external 13.8 V DC power source.

The mic hanger and external speaker outputs are also included in this connector

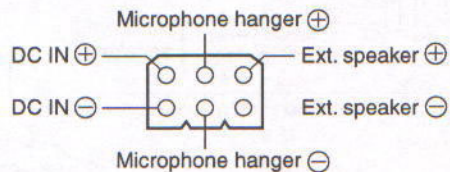
4 HAILER/INTERCOM/FOG HORN CONNECTOR PINS

8-pin plug connects speaker and switches for the hailer, intercom and fog horn functions. With an optional UA-4 audio amplifier, 20 W output is possible from the speaker for the hailer or fog horn function.

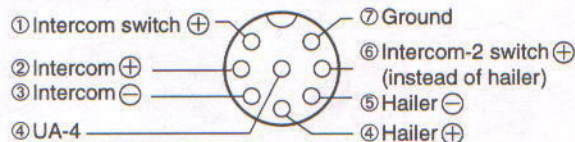
5 OPTIONAL NMEA CONNECTOR

Connects an NMEA device, such as a GPS receiver.

6 ANTENNA CONNECTOR

Connects a marine VHF antenna with a PL-259 connector to the transceiver.

CAUTION: Transmitting without an antenna will damage the transceiver.

■ Connections for hailer/intercom/fog horn

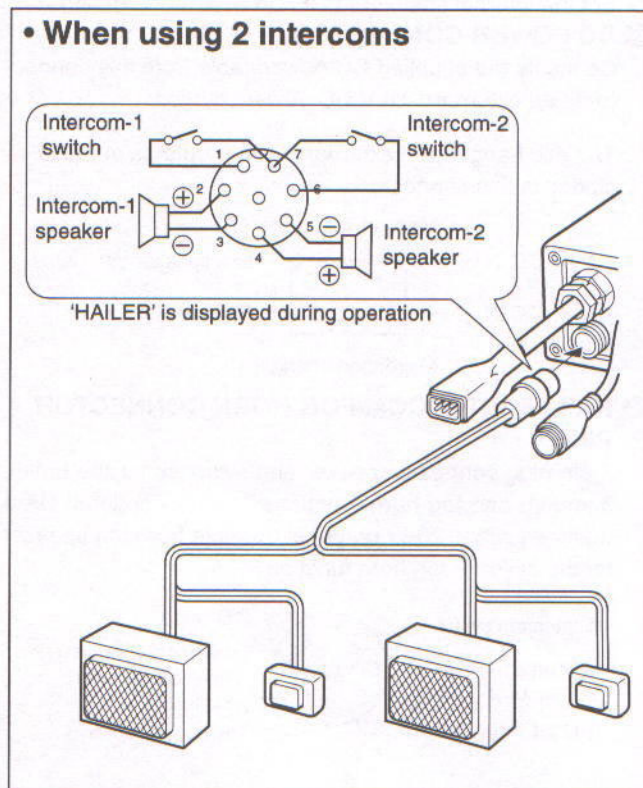
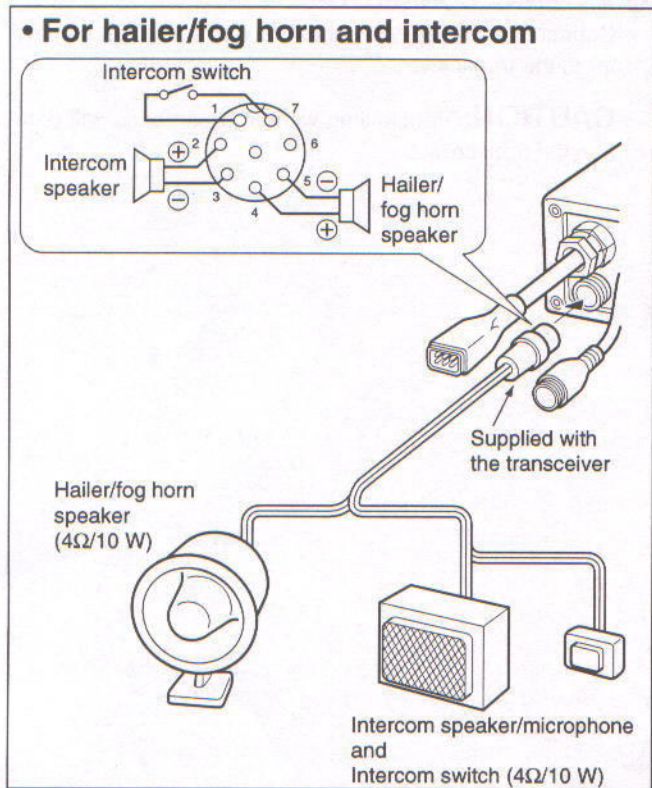

• For hailer/fog horn and intercom with UA-4

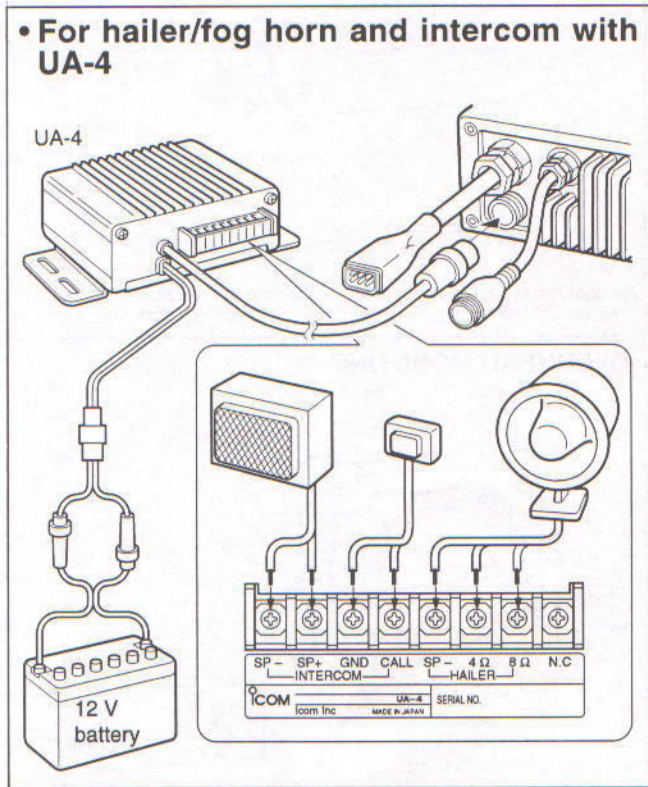

• Connection for GPS

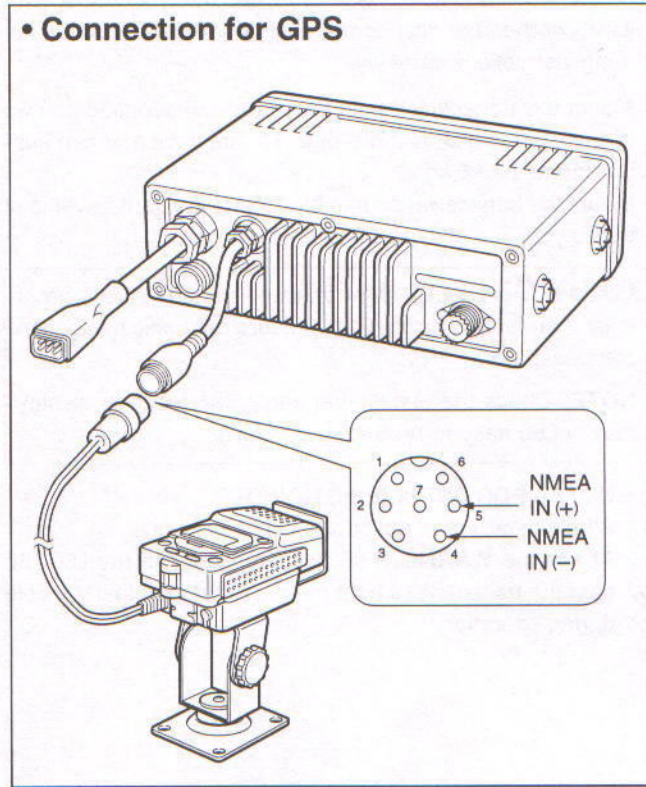

7 CONNECTIONS AND MAINTENANCE

■ Mounting the transceiver

The universal mounting bracket supplied with your transceiver allows overhead or dashboard mounting. Please read the following instructions carefully.

- Mount the transceiver securely with the 4 supplied screws to a surface which is more than 10 mm thick and can support more than 5 kg.
- Mount the transceiver so that the face of the transceiver is at 90° to your line of sight when operating it.

CAUTION: KEEP the transceiver and microphone at least 1 meter away from your vessel's magnetic navigation compass.

NOTE: Check the installation angle; the function display may not be easy-to-read at some angles.

NOTES FOR SUPPLIED STICKER

When installing an optional UX-130 DSC UNIT:

Attach the WARNING sticker supplied with the UX-130 near the transceiver's front panel so that it is clearly visible during operation.

DASHBOARD MOUNTING (with optional MB-66)

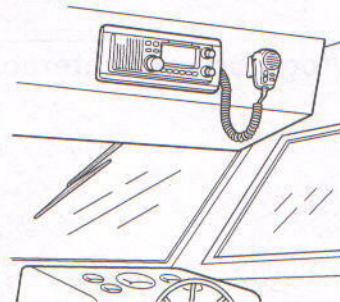

An optional MB-66 is available for mounting the transceiver as above.

OVERHEAD MOUNTING

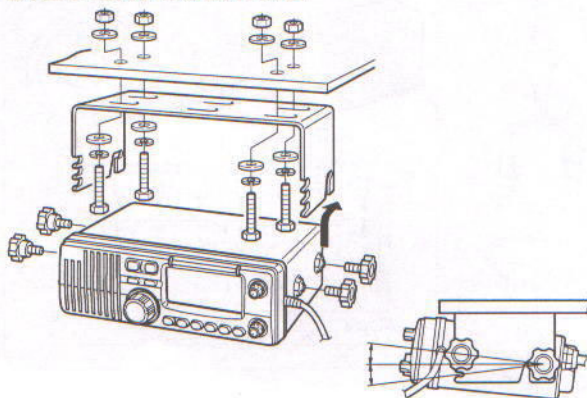

■ Antenna

A key element in the performance of any communication system is an antenna. Ask your Dealer about antennas and the best places to mount them.

■ Fuse replacement

Two fuses are installed in the supplied DC power cable. If a fuse blows or the transceiver stops functioning, track down the source of the problem, if possible, and replace the damaged fuse with a new, rated one.

□ Fuse rating: 10 A

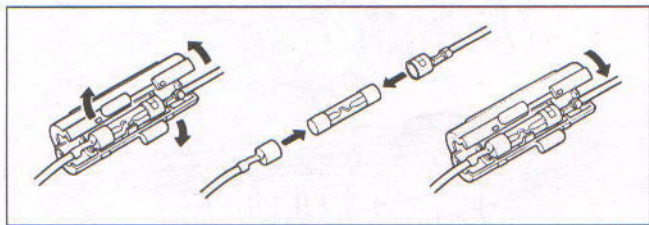

■ Cleaning



If the transceiver becomes dusty or dirty, wipe it clean with a dry, soft cloth.



AVOID the use of solvents such as benzene or alcohol, as they may damage transceiver surfaces.

■ Removing/replacing the case

- ① Turn the transceiver power OFF and disconnect the DC power connector.
- ② Remove the 6 screws located on the rear panel as shown in the diagram below; then, slide the case free of the transceiver.
- ③ Replace the transceiver case; then, replace the 6 screws on the rear panel when you are finished.
 - 10 to 12 kg of torque MUST be applied to insure water resistance.

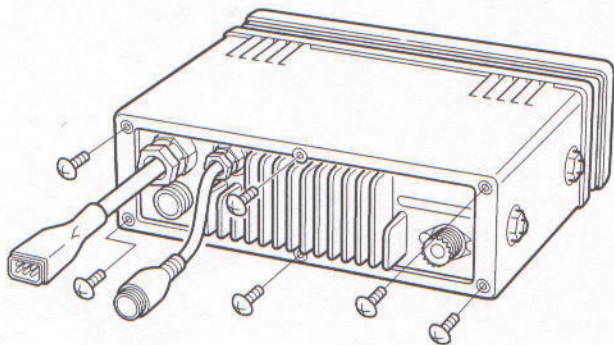

■ Unit installation

- ① Remove the transceiver case as at left.
- ② Install the OPC-457, UT-98 or UX-130 as shown below.
 - When installing the UX-130, be sure to secure it in place with the 2 supplied screws as illustrated.
- ③ Replace the case and secure with the 6 screws as at left.

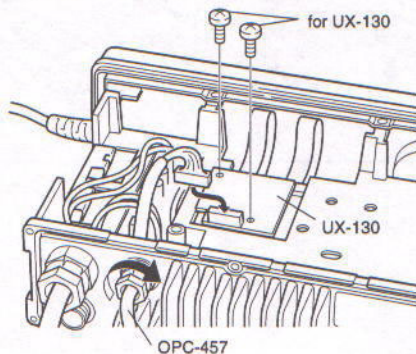
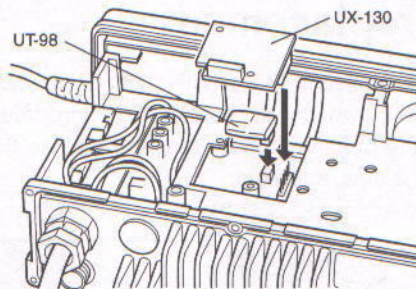

PROBLEM	POSSIBLE CAUSE	SOLUTION	REF.
No power comes on.	<ul style="list-style-type: none"> • Power cord not connected properly. • Blown fuse. 	<ul style="list-style-type: none"> • Check the power cord connection. • Check the polarity of the power connection, then, replace the fuse. 	<p>p. 32</p> <p>p. 37</p>
No sound comes from the speaker.	<ul style="list-style-type: none"> • The hailer or intercom function is activated. • The internal speaker is turned OFF in SET mode. • Handset is out of the cradle (when an optional handset is used). 	<ul style="list-style-type: none"> • Push [CH/WX] to turn the function OFF. • Turn the internal speaker ON in SET mode. • Set the handset into the cradle. 	<p>p. 8</p> <p>pgs. 27, 29</p>
No beeps sound even when a switch is pushed.	<ul style="list-style-type: none"> • Beep function is turned OFF. 	<ul style="list-style-type: none"> • Set beep level to 01 or more in SET mode. 	<p>pgs. 26, 27</p>
Sensitivity is low and only strong signals are audible.	<ul style="list-style-type: none"> • [SQUELCH] is rotated too far clockwise. • Antenna feedline or the antenna connector solder has poor contact or is short circuited. 	<ul style="list-style-type: none"> • Rotate [SQUELCH] counterclockwise to a suitable position. • Check, and if necessary, replace the feedline or solder the antenna connector again. 	<p>p. 8</p> <p>p. 32</p>
Transmitting is impossible or high power cannot be selected.	<ul style="list-style-type: none"> • Transmission is restricted on some channels. 	<ul style="list-style-type: none"> • Change channels. 	<p>p. 9</p>
Desired channel cannot be selected.	<ul style="list-style-type: none"> • Different channel group is selected. 	<ul style="list-style-type: none"> • Push and hold [CH/WX • U/I/C] to select the appropriate channel group (U.S.A., INT or CAN). 	<p>p. 7</p>
No display backlighting.	<ul style="list-style-type: none"> • Backlight function is turned OFF. 	<ul style="list-style-type: none"> • While pushing [HI/LO • DIM], rotate the channel selector to select the desired brightness. 	<p>p. 11</p>
Scan does not start.	<ul style="list-style-type: none"> • No "TAG" channels are programmed. 	<ul style="list-style-type: none"> • Set channels to be scanned as "TAG" channels. 	<p>p. 10</p>
Receive signal cannot be understood.	<ul style="list-style-type: none"> • Voice scrambler has been turned OFF. • Voice scrambler code has not been set correctly. 	<ul style="list-style-type: none"> • Install the optional UT-98, then activate the function. • Reset the scramble code. 	<p>p. 8</p> <p>p. 27</p>

10 VHF MARINE CHANNEL LIST

Channel number			Frequency (MHz)		Channel name
USA	INT	CAN	Transmit	Receive	
	01	01	156.050	160.650	TELEPHONE
01A			156.050	156.050	VTS
	02	02	156.100	160.700	TELEPHONE
02A			156.100	156.100	
	03	03	156.150	160.750	TELEPHONE
03A			156.150	156.150	
	04		156.200	160.800	INTL
04A		04A	156.200	156.200	CCG
	05		156.250	160.850	INTL
05A		05A	156.250	156.250	VTS
06	06	06	156.300	156.300	SAFETY
	07		156.350	160.950	INTL
07A		07A	156.350	156.350	COMMERCIAL
08	08	08	156.400	156.400	COMMERCIAL
09	09	09	156.450	156.450	CALLING
10	10	10	156.500	156.500	COMMERCIAL
11	11	11	156.550	156.550	VTS
12	12	12	156.600	156.600	VTS
13*2	13	13*1	156.650	156.650	BRG/BRG
14	14	14	156.700	156.700	VTS
15*2	15*1	15*1	156.750	156.750	COMMERCIAL
16	16	16	156.800	156.800	CALLING
17*1	17	17*1	156.850	156.850	SAR
	18		156.900	161.500	INTL
18A		18A	156.900	156.900	COMMERCIAL
	19		156.950	161.550	INTL

Channel number			Frequency (MHz)		Channel name
USA	INT	CAN	Transmit	Receive	
19A		19A	156.950	156.950	COMMERCIAL
20	20	20*1	157.000	161.600	PORT OPR
20A			157.000	157.000	PORT OPR
	21		157.050	161.650	INTL
21A		21A	157.050	157.050	CCG
		21B		161.650	CMBS
	22		157.100	161.700	INTL
22A		22A	157.100	157.100	USCG
	23	23	157.150	161.750	INTL
23A			157.150	157.150	USCG
24	24	24	157.200	161.800	TELEPHONE
25	25	25	157.250	161.850	TELEPHONE
		25B		161.850	CMBS
26	26	26	157.300	161.900	TELEPHONE
27	27	27	157.350	161.950	TELEPHONE
28	28	28	157.400	162.000	TELEPHONE
		28B		162.000	CMBS
	60	60	156.025	160.625	TELEPHONE
60A			156.025	156.025	
	61		156.075	160.675	INTL
61A		61A	156.075	156.075	CCG
	62		156.125	160.725	INTL
62A		62A	156.125	156.125	CCG
	63		156.175	160.775	INTL
63A			156.175	156.175	VTS
	64	64	156.225	160.825	TELEPHONE

*1 Low power only

*2 Momentary high power

*3 Receive only (except for DSC transmissions)

VHF MARINE CHANNEL LIST 10

Channel number			Frequency (MHz)		Channel name
USA	INT	CAN	Transmit	Receive	
64A		64A	156.225	156.225	COMMERCIAL
	65		156.275	160.875	INTL
65A	65A	65A	156.275	156.275	PORT OPR
	66		156.325	160.925	INTL
66A	66A	66A*1	156.325	156.325	PORT OPR
67*2	67	67	156.375	156.375	BRG/BRG
68	68	68	156.425	156.425	SHIP-SHIP
69	69	69	156.475	156.475	PLEASURE
70*3	70*3	70*3	156.525	156.525	DSC
71	71	71	156.575	156.575	PLEASURE
72	72	72	156.625	156.625	SHIP-SHIP
73	73	73	156.675	156.675	PORT OPR
74	74	74	156.725	156.725	PORT OPR
75	75	75	Guard	Guard	
76	76	76	Guard	Guard	
77*1	77	77*1	156.875	156.875	PORT OPR
	78		156.925	161.525	INTL
78A		78A	156.925	156.925	SHIP-SHIP
	79		156.975	161.575	INTL
79A		79A	156.975	156.975	SHIP-SHIP
	80		157.025	161.625	INTL
80A		80A	157.025	157.025	SHIP-SHIP
	81		157.075	161.675	INTL
81A		81A	157.075	157.075	CCG
	82		157.125	161.725	INTL
82A		82A	157.125	157.125	CCG

Channel number			Frequency (MHz)		Channel name
USA	INT	CAN	Transmit	Receive	
	83	83	157.175	161.775	CCG
83A		83A	157.175	157.175	CCG
		83B		161.775	CMBS
84	84	84	157.225	161.825	TELEPHONE
84A			157.225	157.225	
85	85	85	157.275	161.875	TELEPHONE
85A			157.275	157.275	
86	86	86	157.325	161.925	TELEPHONE
86A			157.325	157.325	
87	87	87	157.375	161.975	TELEPHONE
87A			157.375	157.375	
88	88	88	157.425	162.025	TELEPHONE
88A			157.425	157.425	COMMERCIAL

WX channel	Frequency (MHz)	
	Transmit	Receive
01	RX only	162.550
02	RX only	162.400
03	RX only	162.475
04	RX only	162.425
05	RX only	162.450
06	RX only	162.500
07	RX only	162.525
08	RX only	161.650
09	RX only	161.775
10	RX only	163.275

CHANNEL NAME KEY

TELEPHONE	: public correspondence
PLEASURE	: pleasure boat use
SAFETY	: safety communications
PORT OPR	: port operations
VTS	: vessel traffic control
SHIP-SHIP	: intership communications
CMBS	: continuous marine broadcast system
COMMERCIAL	: commercial use
USCG	: United States Coast Guard
BRG/BRG	: bridge to bridge communications
INTL	: outside of the US or Canada
SAR	: search and rescue
CCG	: Canadian Coast Guard

11 SPECIFICATIONS

General

- Frequency coverage : Transmit 156–157.5 MHz
Receive 156–163 MHz
- Usable channels : All U.S.A., International and Canadian channels plus 10 weather channels
- Mode : 16K0G3E, (16K0G2B when optional DSC is in use)
- Power supply requirement : 13.8 V DC \pm 15%
- Current drain : Transmit
(at 13.8 V DC) high power 6.3 A
low power 2.0 A
Receive
standby 500 mA
max. audio output 1.5 A
- Frequency stability : \pm 5 ppm
- Usable temp. range : -20°C to $+60^{\circ}\text{C}$;
 -4°F to $+140^{\circ}\text{F}$
- Scan speed : 8 channels/second
- Dimensions : 229(W) \times 78(H) \times 220(D) mm
(projections not included) 9(W) \times 3 $\frac{1}{16}$ (H) \times 8 $\frac{5}{8}$ (D) in
- Weight : 2.5 kg; 5.5 lb

Transmitter

- Output power : High 25 W Low 1 W
- Modulation system : Variable reactance phase modulation
- Max. frequency deviation : \pm 5.0 kHz
- Spurious emissions : Less than -70 dB
- Microphone impedance : 600 Ω

Receiver

- Receive system : Double conversion superheterodyne
- Intermediate frequencies : 1st 21.8 MHz 2nd 455 kHz
- Sensitivity : 0.25 μV (typical) for 12 dB SINAD
- Squelch sensitivity : 0.32 μV at threshold
- Adjacent channel selectivity : More than 75 dB
- Spurious response rejection : More than 75 dB
- Intermodulation rejection : More than 75 dB
- Audio output power : 5 W at 10% distortion
- Audio output impedance : 4 Ω

All stated specifications are subject to change without notice or obligation

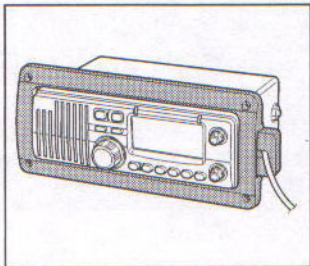

MB-66 FLUSH MOUNT

For mounting the transceiver to a panel. Available in black or white.

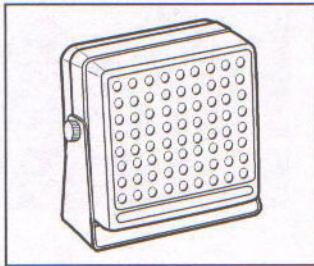

SP-5 EXTERNAL SPEAKER

A large, external speaker for superior audio output.

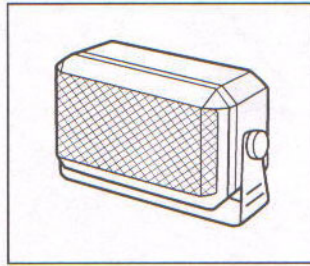

SP-10 EXTERNAL SPEAKER

A compact, external speaker. Features easy installation.

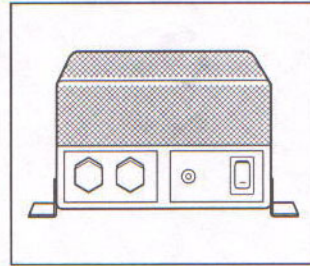

PS-66 DC-DC CONVERTER

Input voltage: 19 to 32 V DC
Output voltage: 13.6 V DC

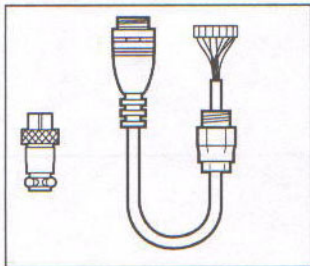

OPC-457 NMEA CABLE

Allows you to connect NMEA equipment such as a GPS receiver.

◆ INTERNAL UNITS

• UT-98 VOICE SCRAMBLER UNIT

Provides private communications. Analog-type voice scrambling unit with 128 scramble codes available.

• UX-130 DSC UNIT

When the UX-130 is installed, the transceiver conforms to U.S. Coast Guard proposal SC-101 for marine digital communications.

Count on us!

A-5408H-1US-③
Printed in Japan
© 1996 by Icom Inc.

Icom Inc.

1-1-32 Kamiminami, Hirano-ku, Osaka 547-0003 Japan