

Humminbird® VHF255S / VHF255SW Operations Manual

531469-1_A



THANK YOU!

Thank you for choosing Humminbird®, America's #1 name in fishfinders. Humminbird® has built its reputation by designing and manufacturing top-quality, thoroughly reliable marine equipment. Your Humminbird® is designed for trouble-free use in even the harshest marine environment. In the unlikely event that your Humminbird® does require repairs, we offer an exclusive Service Policy - free of charge during the first three years after purchase, and available at a reasonable rate after the three-year warranty period expires. For complete details, see the separate warranty sections in the back of this manual. We encourage you to read this operations manual carefully in order to get full benefit from all the features and applications of your Humminbird® product. Contact our Customer Resource Center at either 1-800-633-1468 or visit our website at www.humminbird.com.

OPERATOR WARNINGS

This radio will transmit/receive on channels that are restricted in the U.S. To operate on these channels you must have explicit permission from the proper governmental authority. Refer to the list of U.S. channels in this manual and look under the "Type of Traffic" column to find out whether a particular chosen channel has restricted use. For users that require a license, such as commercial users, please contact your nearest FCC field office to obtain a license. If you have questions as to whether or not your application requires a license you can contact the FCC at <http://wireless.fcc.gov/marine/>.

NOTE: This device complies with part 15 of the FCC Rules. Operation is subject to the following two conditions: 1) This device may not cause harmful interference, and 2) this device must accept any interference received, including interference that may cause undesired operation.

WARNING! Alterations and/or modifications to this product are NOT permitted as they may result in violations of FCC rules and regulations.

WARNING! Disassembly and repair of this electronic unit should only be performed by authorized service personnel. Any modification of the serial number or attempt to repair the original equipment or accessories by unauthorized individuals will void the warranty. Handling and/or opening this unit may result in exposure to lead, in the form of solder.

WARNING! This product contains lead, a chemical known to the state of California to cause cancer, birth defects and other reproductive harm.

NOTE: You should record your VHF255S serial number here for future reference. The serial number is located on the left side panel of the radio base station.

Serial Number: _____.

NOTE: You should record your Maritime Mobile Service Identity (MMSI) number here for future reference. You must obtain the MMSI from an official source of recreational MMSI numbers, either <http://www.boatus.com/mmsi> or <http://www.seatow.com/boatingsafety/mmsiinfo.htm>.

MMSI Number: _____

Humminbird® is a registered trademark of Humminbird®.

© 2005 Humminbird®, Eufaula AL, USA. All rights reserved.

TABLE OF CONTENTS

VHF255S Introduction	6
How VHF Radio Works	6
Features Overview	7
Maritime Mobile Service Identity (MMSI)	9
VHF255S Controls - Radio Base Station Front	11
VHF255S Controls - Radio Base Station Rear	13
VHF255S Controls - Microphone Handset	14
What's On the Display	15
Installation Overview	17
Parts Supplied	17
Connections Overview	20
1. Decide Where to Install the Radio Base Station.	21
2. Install the Radio Base Station	22
3. Attach the Antenna Cable to the Radio	25
4. Install the Microphone Mounting Bracket	25
5. Attach a GPS Receiver (Optional-Purchase)	27
Using Your VHF255S	28
Before You Use Your Radio: FCC Radio Frequency (RF) Compliance Requirements	29
Before You Use Your Radio: FCC Licensing Requirements	29
Before You Use Your Radio: FCC Privacy and Priority Channel Requirements	30
1. Turning the Power On/Off.	30
2. Adjusting Squelch	31
3. Selecting a Channel	31
4. Selecting High/Low Power	32
5. Transmitting and Receiving	32
6. Selecting the U.S./International/Canadian Bands	32
7. Selecting a Weather Channel and Turning On Weather Alert	33
8. Accessing the 16/9 Priority Channels	34
9. Adding/Deleting Channels to/from Memory.	34

10. Accessing Channels Saved to Memory	35
11. Using the Transmit Time-Out Timer (TOT)	35
12. Scanning.....	35
13. Using the Watch Monitor Modes	37
14. Digital Selective Calling (DSC)	38
15. Making a Distress Call	41
16. Making Individual Routine Calls.....	43
17. Receiving Calls.....	45
18. Resetting the Radio.....	48
19. Position Indication.....	48
Setup Menu	50
Contact List	51
Local/Distant	53
Backlight Adjustment	53
Contrast Adjustment	54
GPS/Time Submenu	55
Manually Enter GPS Data.....	56
Settings Submenu.....	57
Position Display On/Off	57
Time Display On/Off	58
Time Offset (Local Time).....	58
Time Format	59
Course/Speed Display Options (COG/SOG).....	59
Radio Setup Submenu	60
Channel Name Display and Editing.....	61
Ring Volume Adjustment	62
Beep Volume Adjustment.....	63
Turning the Internal Speaker On/Off.....	63
DSC Setup Submenu	64
Enter Your User MMSI	65
Create and Manage Group MMSIs.....	67
Individual Reply.....	69
DSC Enable	69
Position Reply	70
Reset	70

Maintenance	71
Troubleshooting	71
VHF255S Doesn't Power Up	71
No Sound from the Speaker	72
Transmitting is Impossible, or High Power Can't Be Selected	72
Low Receiver Sensitivity	72
3-Year Limited Warranty	73
Humminbird® Service Policy	74
Specifications	76
Marine Channels	77
Menu Tree	84
Contact Humminbird®	89

VHF255S INTRODUCTION

The Humminbird® VHF255S represents state-of-the-art high tech VHF radio engineering, and is skillfully designed and constructed with the finest components. It is constructed to commercial-grade standards to give you clear, reliable communication.

HOW VHF RADIO WORKS

The most popular method of communicating with other boats is via very high frequency (VHF) radio. In technical terms, this is similar to the way that commercial radio stations transmit. VHF equipment is relatively simple, and can therefore be compact and low cost.

To ensure that maritime users do not cause interference for other radio users, a part of the radio spectrum has been allocated specifically to this group of users. These reserved frequencies have been numbered, for example, Channel 16 (usually abbreviated Ch16) actually refers to a frequency of 156.800 MHz.

Because radio does not recognize geographic or political boundaries, and to make sure that boats traveling on international voyages can always communicate, the VHF marine band is the same worldwide. There are 55 international marine channels, a similar number of private channels (allocated on a local basis to commercial organizations) and some other unique national channels.

The United States and Canada employ a slightly different application of marine channels, using the same frequency but allocating more simplex (one-way) rather than duplex (two-way) channels.

National channels include WX (weather) channels in the U.S., fishing channels in Norway and the marina channels M and M2 in the U.K. To make sure that your radio is fitted with the correct local channels, be sure to purchase type-approved equipment for the country of intended use.

FEATURES OVERVIEW

The Humminbird® VHF255S is a VHF Digital Selective Calling (DSC) Base Station marine band radio with the following features:

- Access to all available U.S., International, and Canadian channels (currently allocated).
- Allows unlimited memory channels for quick recall and memory scan.
- Provides as many as 20 user-programmable names with MMSI, 10 distress calls and 20 individual calls for DSC communications. See the ***Maritime Mobile Service Identity (MMSI)*** section for more information about this important feature.
- Rotary volume control with power on/off, rotary channel selector and rotary adjustable squelch knob provide convenient radio operation.
- Exceptional waterproofing performance complies with Japanese Industry Standard Level 7.
- High/Low Transmit Power Selection allows you to select either High Power Transmit (25 Watts) for long-range communications or Low Power Transmit (1 Watt) for shorter-range communications to save battery power.
- Separate Channel 16/9 Priority key provides quick emergency calling on channels 16 or 9. Emergency Channel 16 is the universal marine channel most frequently-used for distress or safety communications. In addition, you can use the 16/9 channel key to access Channel 9, an alternate frequency for distress or safety in some areas in the event Channel 16 is congested. Check with local authorities to see which channel is used in your area.
- Adjustable brightness of backlight on the large LCD for good visibility in various conditions.
- Built-in speaker provides clean, crisp audio performance.
- External interface makes it easy to connect to an optional-purchase GPS Receiver and/or an optional-purchase external speaker, and supports the NMEA 0183 National Marine Electronics Association standard for data communication.

- Firm and reliable gimbal mounting bracket for the radio base station.
- Large LCD (2" x 1.5") is easy to read, with backlit display to allow operation in low light conditions.
- Phase Lock Loop (PLL) controlled circuitry provides accurate and stable channel selection.
- Memory Channels feature allows you to save channels so that they are easy to retrieve for future use.
- SQUELCH Knob allows you to eliminate static and background noises during communications.
- BAND/SAVE Key allows you to select between the U.S. Channel Band, the International Channel Band or the Canadian Channel Band.
- SCAN Key allows you to scan all channels, to scan channels saved in memory or to conduct a priority scan. Normal Scan feature allows you to scan all available channels for active channels, while Memory Scan feature allows you to rapidly scan pre-programmed channels to locate active channels. Priority Scan feature allows you to include Channel 16 in the scan to make sure that you don't miss distress or emergency calls.
- Dual Watch feature allows you to scan alternately between your currently-selected channel and Channel 16 to make sure you don't miss distress or emergency calls.
- Tri Watch feature allows you to scan alternately between your currently selected channel, Channel 16, and Channel 9 to make sure you don't miss distress or emergency calls.

MARITIME MOBILE SERVICE IDENTITY (MMSI)

The Maritime Mobile Service Identity (MMSI) number is the nine-digit number used on marine radios like your VHF255S that are capable of using Digital Selective Calling (DSC). This number is used like a telephone number to call other vessels individually and automatically.

NOTE: You must get an MMSI assigned to you before you can perform this procedure, and you will **ONLY** be allowed to perform this operation once. You must enter your user MMSI before you can use the DSC functions. If there is no User MMSI stored and an attempt is made to use the DSC function of the radio, the LCD will display the following message:

DSC IS NOT
OPERATIONAL
PLEASE ENTER
MMSI

If you are a non-commercial user in U.S. waters (e.g. a recreational boater), you must obtain an MMSI from either BOAT US or SEATOW. The official sources of recreational MMSI numbers are: <http://www.boatus.com/mmsi/> and <http://www.seatow.com/boatingsafety/mmsiinfo.htm>. They are both sanctioned by the FCC and the U.S. Coast Guard and are therefore the official points of registration for recreational MMSI numbers in the U.S.

NOTE: The following website is the official Coast Guard website that administers MMSIs. For full details of the rules and regulations of MMSI numbers, please visit: <http://www.navcen.uscg.gov/marcomms/gmdss/mmsi.htm>.

To obtain an MMSI assignment:

1. Contact BOAT US or SEATOW to obtain a unique MMSI number for your VHF255S radio. Go to: <http://www.boatus.com/mmsi/> or <http://www.seatow.com/boatingsafety/mmsiinfo.htm> and follow the instructions.
2. When you have obtained your unique MMSI number, write it down IMMEDIATELY in the space provided on the inside front cover of this manual.

NOTE: You should also write down the serial number (found on the left panel of the radio base station) on the inside front cover of this manual, for future reference.

To enter your assigned MMSI into your radio:

1. Press and hold the DSC/MENU key; the Text area on the LCD will display the Setup Menu list.
2. Rotate the CH/ENTER knob to select DSC SETUP from the Setup Menu list, and push the CH/ENTER knob to display the DSC Setup Submenu.
3. Rotate the CH/ENTER knob to select USER MMSI from the DSC Setup Submenu and push the CH/ENTER knob to display the USER MMSI entry screen.

NOTE: If an existing User MMSI has already been stored, it will be displayed, stop here. You CANNOT edit the User MMSI once it has been entered and confirmed.

4. If the User MMSI is blank, a dashed line will be displayed. Turn the CH/ENTER knob back and forth to enter the User MMSI along the dashed line. Press the CH/ENTER knob to confirm each correct entry and to be advanced automatically to the next digit.

NOTE: If you make an error, turn CH/ENTER knob one click counter-clockwise until < appears, then press the CH/ENTER knob to back up and correct the error.

5. When you have selected the desired numbers, press the CH/ENTER knob to store your User MMSI.
6. You will be asked to re-enter your User MMSI again to confirm it; once you have re-entered your User MMSI, press and hold the CH/ENTER knob to permanently store your User MMSI and return to the DSC Setup Submenu.

NOTE: To exit the DSC Setup Submenu or one of the further submenus under it, press the 16/9 or CANCEL/WX keys until you have left the submenus. You will also exit the DSC Setup Submenu automatically by turning the unit off. All changes are saved in EEPROM (except for manually-entered GPS data).

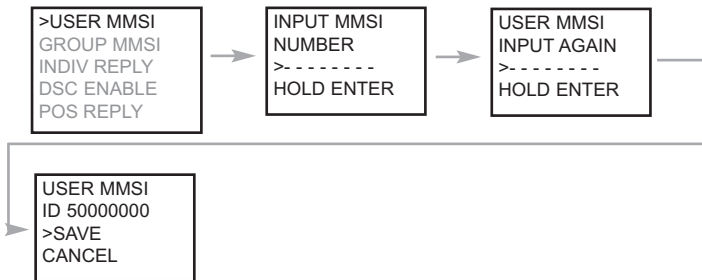

7. You can view your stored User MMSI at any time by selecting user MMSI from the DSC SETUP menu.

VHF255S CONTROLS - RADIO BASE STATION FRONT

The following drawing shows the Humminbird® VHF255S controls on the front of the radio base station:

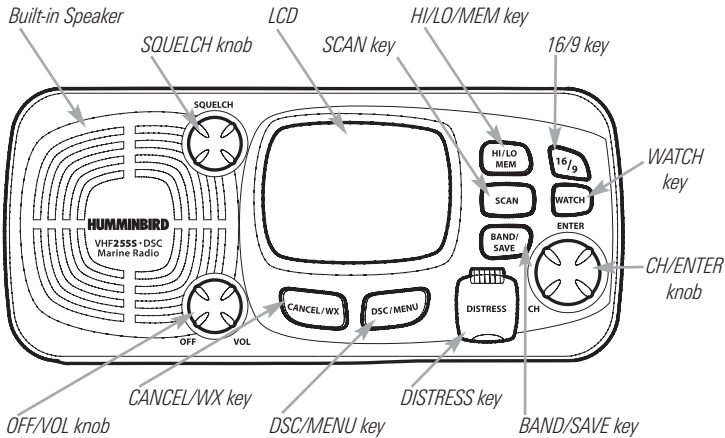

NOTE: On dual function keys, such as the BAND/SAVE key, a quick press and release will activate the first function on the key (to the left of the slash), in this case the BAND function. A press and a hold will activate the second function on the key (to the right of the slash), in this case the SAVE function.

OFF/VOL: 0-270° rotary control knob. Turn clockwise to power on. Continue to turn until you reach a comfortable audio level.

SQUELCH: Use this knob to eliminate static and background noises during communications.

CH/ENTER: Rotate this knob to change the current number and change values in menu mode or during programming. Press this knob to enter values.

BAND/SAVE: Use this dual function key to select a band (U.S., International or Canada) and to save channels to memory.

CANCEL/WX: Use this dual function key to cancel your last selection or change your selection without saving. This allows you to step back one level on the menu mode. Use this key to cancel DSC Distress calls and auto-retransmission of Distress calls. Press and hold this key to enter WX (Weather) mode.

DSC/MENU: Use this dual function key to view the DSC Call List or enter the Setup Menu. The DSC Call List is used for making DSC Calls. The Setup Menu is used to change the radio settings.

HI/LO/MEM: Press and release the HI/LO/MEM key to toggle between 25 Watt power output and 1 Watt output. "HI" or "LO" icon appears on LCD display to indicate setting. Press and hold the key to select Memory mode.

SCAN: Use this key to start and stop normal and memory scans or to include priority channels into the current scan. If you have saved memory channels, then pressing the SCAN key will only scan the memory channels.

WATCH: Use this key to start or stop Dual Watch or Tri Watch modes.

16/9: Press and release the 16/9 key to select Channel 16 first; further presses of the 16/9 key toggles between Channel 16 and the previous channel. Pressing and holding the 16/9 key will take you to Channel 9. Further presses will take you back to toggling between Channel 16 and the previous channel. Press the 16/9 key at any time as a quick way to exit all menus and return to Normal mode, Channel 16.

DISTRESS: Use this key to send a distress signal in an emergency. See *Using Your VHF255s, 14. Digital Selective Calling (DSC)* for details of sending the call. This key is protected by a spring cover to prevent accidental presses. The DSC/Distress features function only after you have entered an MMSI.

VHF255S CONTROLS - RADIO BASE STATION REAR

The following drawing shows the Humminbird® VHF255S connections on the rear of the radio:

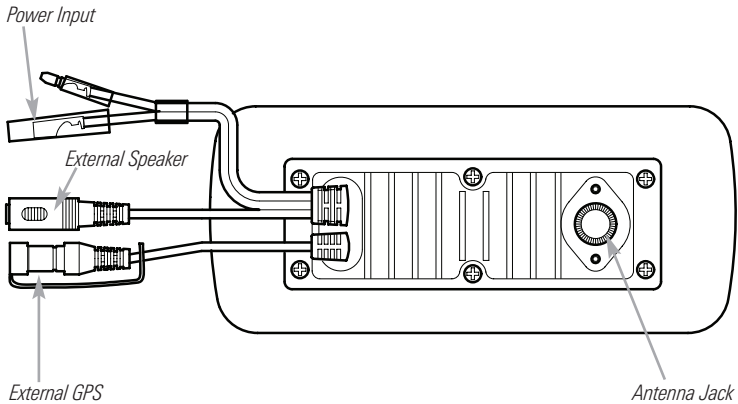

Power Input: Allows you to connect the radio to the boat's 12 VDC power system.

External Speaker: Allows you to connect the radio to an optional-purchase external speaker.

External GPS: Allows you to connect the radio to an optional-purchase GPS receiver to acquire the position of your vessel and the GMT time.

Antenna Jack: Allows you to connect a suitable antenna to your marine VHF radio.

VHF255S CONTROLS - MICROPHONE HANDSET

The following drawing shows the Humminbird® VHF255S controls located on the microphone handset:

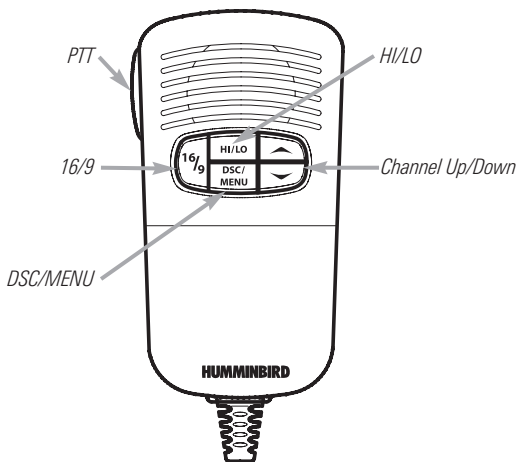

Channel Up/Down: Use these keys to change channels, as well as to change values while editing settings.

16/9: Press and release the 16/9 key to select Channel 16 first; further presses of the 16/9 key toggles between Channel 16 and the previous channel. Pressing and holding the 16/9 key will take you to Channel 9. Further presses will take you back to toggling between Channel 16 and the previous channel. Press the 16/9 key at any time as a quick way to exit all menus and return to Normal mode, Channel 16.

HI/LO: Use this dual function key to toggle between 25 Watt power output and 1 Watt output. "HI" or "LO" icon appears on LCD display to indicate setting.



PTT (Push-To-Talk): Push and hold the Push To Talk (PTT) key while speaking and release this key to listen to incoming transmissions.

DSC/MENU: Use this dual function key to view the DSC Call List or enter the Setup Menu. The DSC Call List is used for making DSC Calls. The Setup Menu is used to change the radio settings.

WHAT'S ON THE DISPLAY

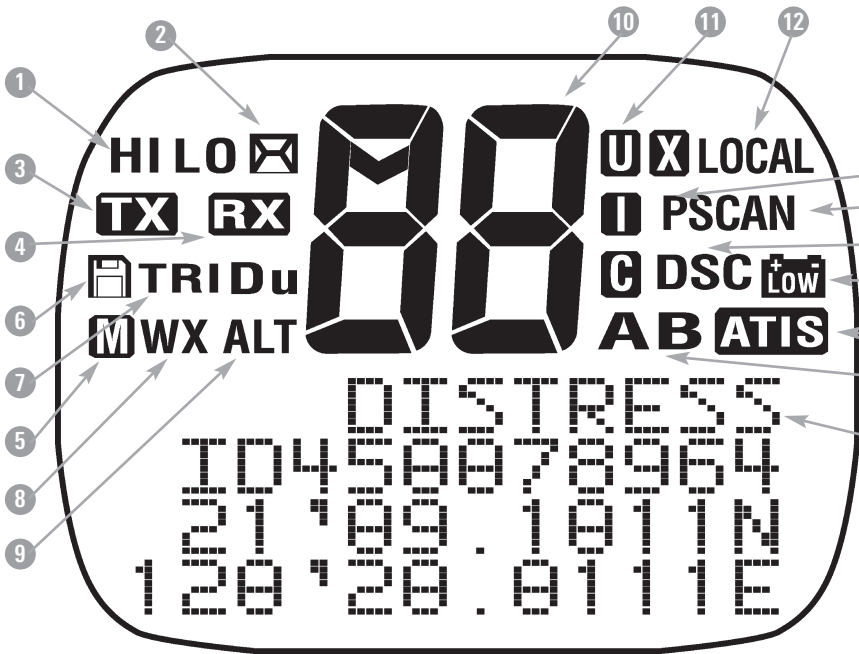
The Humminbird® VHF255S uses an LCD display, together with keys and various control knobs on the front panel. The following is a typical view you might see on the display at initial power-up.



- 1 **HI LO** Transmission power mode High (HI) 25 W or Low (LO) 1 W.
- 2  Indicates an incoming DSC call or, if blinking, to notify you of any unread Call Log messages.
- 3 **TX** Indicates that the radio is transmitting a radio signal.
- 4 **RX** Indicates that the radio is receiving a radio signal.
- 5 **M** Indicates that the radio is in Memory mode.
- 6  Indicates that the current channel has been saved in memory.

the radio base station and microphone handset, to provide access to user functions. The figure shows a

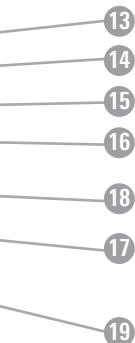

- 7 **TRIDu** Indicates current Watch mode, Dual or Tri Watch.
- 8 **WX** Indicates that Weather Channel mode is active. U.S. and Canada only.
- 9 **ALT** Indicates that a weather alert is being received. U.S. and Canada only.
- 10 **88** Indicates current channel selected.
- 11 **UIC** Indicates which of the three available bands are selected: the U.S. band, the International band, or the Canadian band, respectively.
- 12 **LOCAL** Indicates that the radio is in Local reception mode, which decreases receiver sensitivity in high traffic areas in order to decrease unwanted distant transmissions.
- 13 **PSCAN** Indicates that the radio is in Priority Scan mode.
- 14 **SCAN** Indicates that the radio is in Normal Scan mode.
- 15 **DSC** Indicates that DSC capability is available.
- 16 **Low** Battery Low indicates vessel battery voltage is low.
- 17 **AB** Channel suffix, if applicable.
- 18 **ATIS** Indicates enabled for use in European inland waterways.
- 19 **Dot Matrix** Indicates special conditions or radio functions.

INSTALLATION OVERVIEW

Following are instructions for the installation of your radio. Before you start installation, we encourage you to read these instructions carefully in order to get the full benefit from your Humminbird® VHF255S radio.

To install your VHF255S radio, you will perform the following steps:

1. Decide where to install the radio base station.
2. Install the radio base station.

***NOTE:** You have the option of gimbal bracket mounting, which can either be mounted on the dash or overhead and allows rotation of the radio during operation, or recessed mounting into a dashboard or other appropriate surface.*

3. Attach the antenna cable to the radio.
4. Install the microphone mounting bracket.
5. Attach the radio to an optional-purchase GPS Receiver (strongly recommended).

PARTS SUPPLIED

Before installing your VHF255S, please make sure that the following parts are included in your installation kit:

RADIO BASE STATION:

- 25 Watt VHF255S Fixed Mount radio base station (1).

Radio Base Station Gimbal Mounting Bracket Kit:

- Gimbal mounting bracket (1).
- Gimbal mounting knobs (2).
- Self-tapping screws (4).
- Flat screws (4).
- Plain washers (4).
- Spring washers (4).
- Nuts (4).

Radio Base Station Recessed Mounting Kit:

NOTE: Use the recessed mounting bracket instead of the gimbal mounting bracket for recessed mounting applications.

- Recessed mounting bracket (2).
- Caps (4).
- Nuts (4).
- M5x10 Screws (2).
- M5x32 Screws (4).

MICROPHONE HANDSET:

- Microphone handset (1).

Microphone Handset Mounting Bracket:

- Microphone mounting bracket (1).
- Self-tapping screws (2).
- Flat screws (2).
- Plain washers (2).
- Spring washers (2).
- Nuts (2).

CABLES:

- 4.25 ft (1.30 m) power supply cable with fuse holder (1).
- 2.0 ft (0.6 m) GPS NMEA connection cable (for optional-purchase GPS Receiver) (1).
- 2.65 ft (0.8 m) external speaker connection cable (for optional-purchase external speaker) (1).

NOTE: If you find that any items are missing from your installation kit, call our Customer Resource Center at 1-800-633-1468 or visit our website at www.humminbird.com.

In addition to the hardware supplied with your VHF255S, you will need a powered hand drill and various drill bits, Phillips and flat head screwdrivers, a ruler or measuring tape, pen or pencil, and marine-grade silicone sealant.

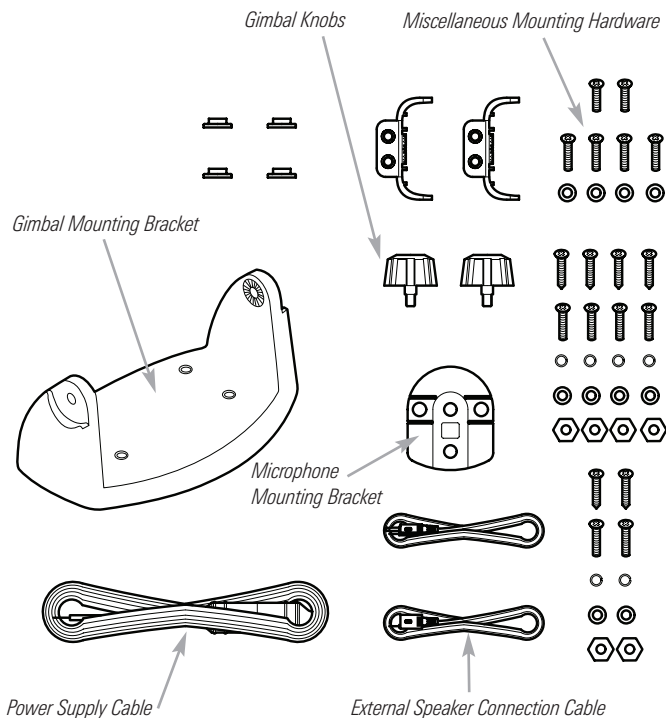

CONNECTIONS OVERVIEW

In the following steps, you will be making at least one of the following connections:

- **Power Supply:** Your radio is powered by your boat's 12 VDC power system. The solid red cable is positive and the black cable with the red stripe is negative.
- **External Speaker (optional-purchase):** If needed, you can connect your radio to an external speaker with the supplied connection cable. The white cable is positive and the thinner black cable is negative.
- **GPS Receiver (optional-purchase):** When your VHF255S marine radio is connected by the GPS cable to a GPS Receiver, it can obtain both its current location (longitude and latitude) and the time (GMT).

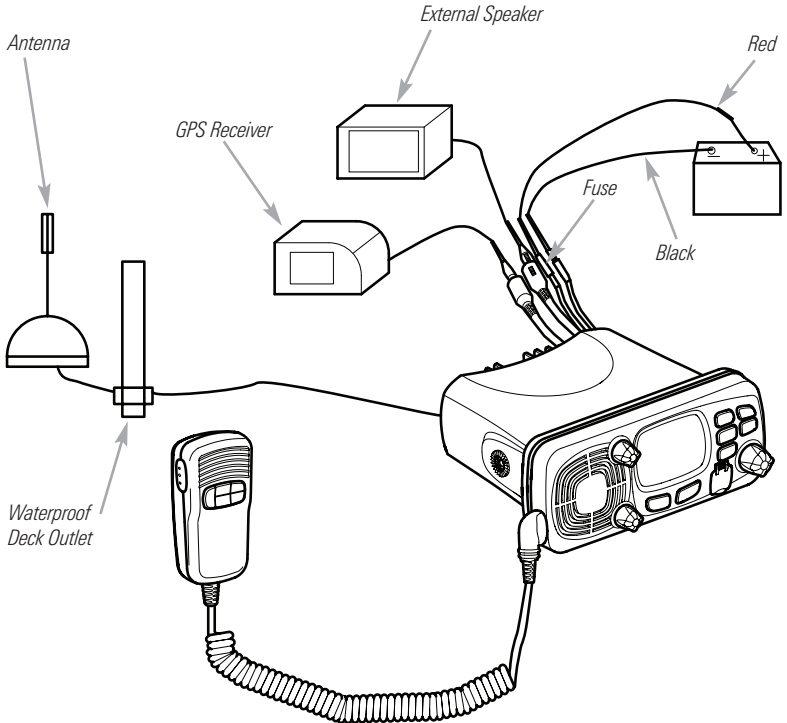

1. DECIDE WHERE TO INSTALL THE RADIO BASE STATION

Before you install the radio base station, you should find a mounting location for it that:

- Does not allow the radio to interfere with, nor receive interference from, nearby equipment, such as other RF equipment and magnetic compasses;
- Provides accessibility to the front panel controls;
- Allows connection to a power supply and an antenna;
- Has free space nearby for installing the microphone mounting bracket;
- Is located so that the base of the antenna can be mounted at least 3.3 feet (1 meter) from where people will be when the radio is operating.

WARNING: Failure to comply with the above requirement may expose those closer than the recommended boundaries to absorb enough RF radiation to exceed the Maximum Permissible Exposure (MPE) limit defined by the FCC. It is the responsibility of the radio operator to make sure that both the radio operator and any other people in the vicinity of the radio comply with MPE limits while the radio is transmitting.

The supplied gimbal mounting bracket allows you to mount your radio base station on any near horizontal surface, from overhead to any console or countertop on your boat.

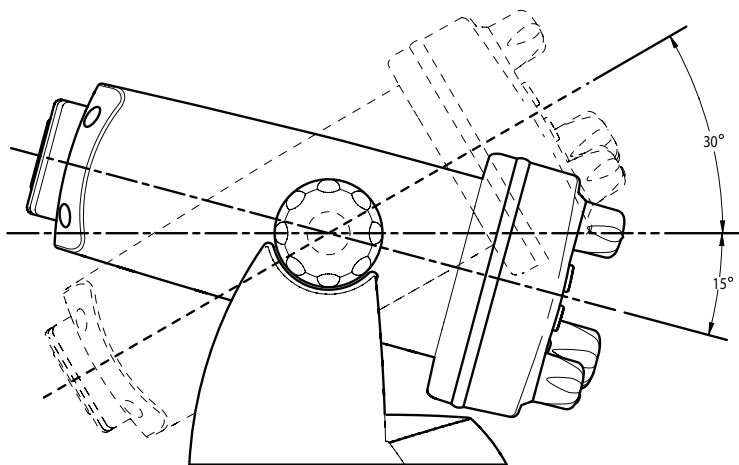

2. INSTALL THE RADIO BASE STATION

Mount the VHF255S radio base station on your vessel, using the mounting location determined in the previous procedure, and one of the two following procedures, gimbaling mounting or recessed mounting.

NOTE: You have the option of gimbaling mounting, which can either be mounted on the dash or overhead and allows rotation of the radio during operation, or recessed mounting into a dashboard or other appropriate surface.

To install the radio base station using the regular gimbaling mounting bracket:

1. Place the mounting bracket on the mounting surface and use a pencil to mark the location of the four holes in the bracket where the fasteners will be attached.

CAUTION: Before drilling, make sure that there is nothing behind the mounting surface that might be damaged while drilling the mounting holes.

2. Set the bracket aside, then drill four mounting holes at the marked locations. If you plan to use the supplied mounting screws, make sure the drill bit you use is slightly smaller than the screw diameter of the mounting screw. If you plan to use the supplied mounting nuts and bolts, make sure the drill bit you use is slightly larger than the diameter of the supplied bolt. Next, align the mounting bracket with the drilled holes, making sure that it is oriented correctly.
3. Insert each of the four supplied mounting fasteners through a spring washer, then through a flat washer, and then into the mounting holes. Secure the bracket to the mounting surface by tightening the mounting screws with a screwdriver or nutdriver, being careful not to overtighten the fasteners. If you are using the supplied mounting bolts, then you will need to hold the nuts on the backside of the mounting surface with a wrench while tightening the bolts with a screwdriver or nut driver, being careful not to overtighten the fasteners.
4. Mount the radio base station onto the bracket, making sure to match the protrusions on the inside of the two arms of the bracket with the indentations on the two sides of the radio base station.
5. Insert the supplied mounting knobs through the bracket arms and into the holes on each side of the radio. The gimbaling bracket allows you to loosen the knobs at each pivot in order to adjust the viewing angle of the radio and then to hold the selected viewing angle by tightening the knobs again.

NOTE: You should only tighten the knobs by hand.

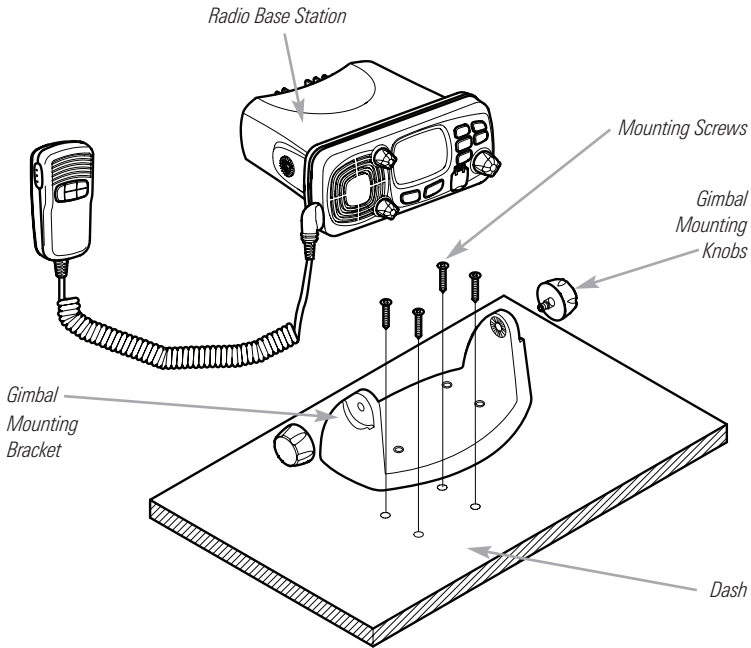

CAUTION: Keep the radio and microphone handset at least 3.3 feet (1 meter) away from any magnetic devices on your boat (such as a compass).

To install the base station using the recessed mounting kit:

1. Tape the Recessed Mounting installation template onto the chosen mounting location.

CAUTION: If your dash exceeds 3/5" (15 mm) in thickness, you will not be able to recess mount the radio. Use the previous procedure for gimbal mounting the radio instead.

CAUTION: Before drilling or cutting into the dash, make sure that there is nothing behind the mounting surface that might be damaged by performing these procedures.

2. Drill a saw blade entry hole, as indicated on the mounting template.
3. Cut out the area inside the dashed line.
4. Remove the installation template and slide the radio into the cavity.

5. Working from the rear of the dash, align the ratcheted mounting circles on each side of the radio with the central hole in each mounting bracket.
6. Use the two short M5x10 screws to screw the mounting brackets to the sides of the radio.
7. Slide two M5x32 screws through the screw hole in the mounting bracket, then attach the lock nut and the stopper. If your dash exceeds 1/2" (13 mm) in thickness, you have the option of discarding the stopper nut if necessary.
8. Tighten the M5x32 screws until the radio is held against the rear of the dash.
9. Tighten the lock nuts to secure the installation. Do not overtighten.

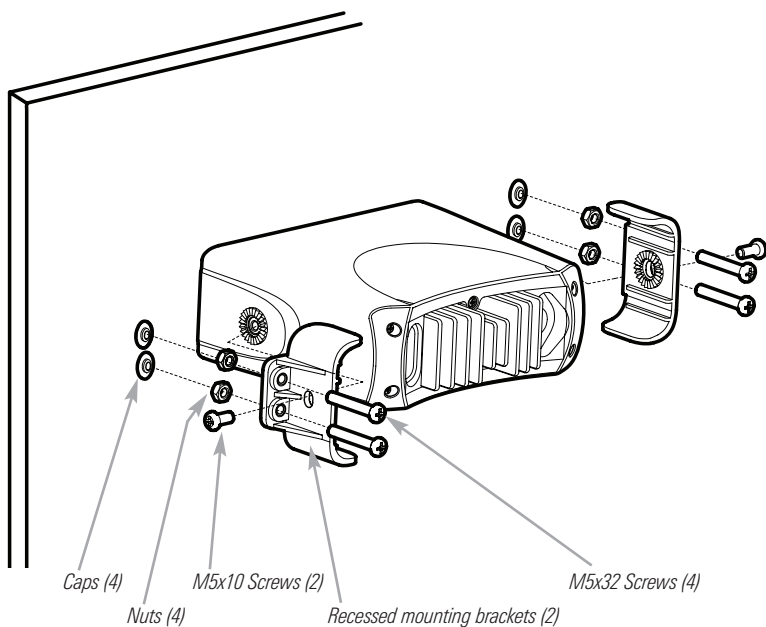

3. ATTACH THE ANTENNA CABLE TO THE RADIO

A suitable antenna must be mounted in a safe location and connected to the radio base station before turning on the radio. A very important factor affecting the performance of any radio communication system is the selection of a suitable antenna. Consult your dealer about antennas and ask them to help you select a suitable antenna for your radio. Refer to the following guidelines for best results.

For optimal radio performance and to minimize human exposure to Radio Frequency (RF) and Electromagnetic Energy (EME), make sure the antenna is:

- Connected to the radio before powering up the radio.
- Properly mounted according to the antenna manufacturer's recommendations.
- Located at least three feet (one meter) from people while it is transmitting.
- Located at least 3.3 feet (1 meter) from the radio base station transceiver and microphone handset.
- Using a standard PL259-type (UHF-type) connector.

WARNING: Failure to comply with the above requirement may expose those closer than the recommended boundaries to absorb enough RF radiation to exceed the Maximum Permissible Exposure (MPE) limit defined by the FCC. It is the responsibility of the radio operator to make sure that both the radio operator and any other people in the vicinity of the radio comply with MPE limits while the radio is transmitting.

4. INSTALL THE MICROPHONE MOUNTING BRACKET

Find a location near the base station for the microphone mounting bracket. The distance between the base station and the microphone mounting bracket should be shorter than the length of the microphone cable.

CAUTION: Keep the radio base station and microphone at least 3.3 feet (1 meter) away from any magnetic devices on your boat (such as a compass).

1. Place the microphone mounting bracket on the surface where you want to attach it, and use a pencil to mark the location of the two mounting holes on the mounting surface.

CAUTION: Before drilling, make sure that there is nothing behind the mounting surface that might be damaged while drilling the mounting holes. Also, if the back side of the mounting surface is inaccessible or difficult to reach then you should probably use the supplied self-tapping screws instead of the supplied mounting nuts and bolts.

CAUTION: If you cannot reach behind the mounting surface to attach the nuts to the bolts, use the supplied self-tapping screws to fasten the bracket instead.

2. Set the bracket aside, then drill two mounting holes at the marked locations. If you plan to use the supplied mounting screws, make sure the drill bit you use is slightly smaller than the screw diameter of the mounting screw. If you plan to use the supplied mounting nuts and bolts, make sure the drill bit you use is slightly larger than the diameter of the supplied bolt. Next, align the mounting bracket with the drilled holes, making sure that it is oriented correctly.
- 3a. Insert each of the two mounting screws and secure the bracket to the mounting surface.

or

- 3b. Use the supplied bolts, spring washers, plain washers and nuts to secure the bracket to the mounting surface.
4. Insert the two mounting screws and fasten them with a suitable screwdriver or nut driver, making sure not to overtighten the screws.

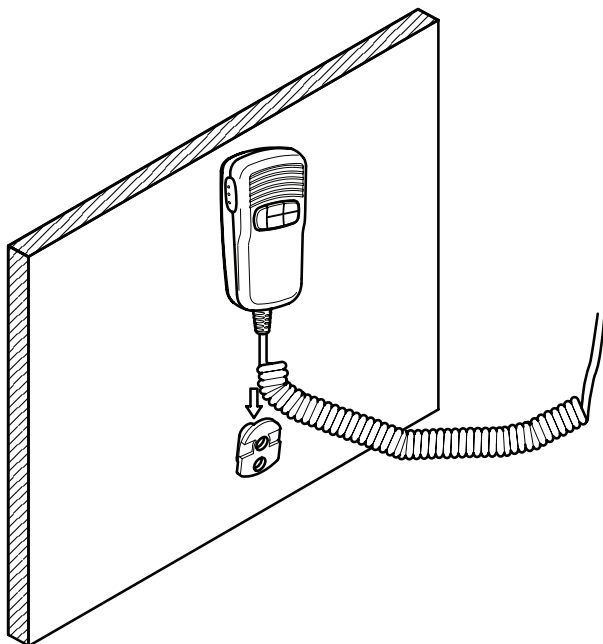

5. Mount the microphone onto the bracket.

5. ATTACH A GPS RECEIVER (OPTIONAL-PURCHASE)

It is strongly recommended that you use your Humminbird® VHF255S with an optional-purchase GPS Receiver. You will not be able to take full advantage of all of the Digital Signal Calling (DSC) features without connecting a GPS Receiver to the radio. Perform the following procedure to connect a GPS Receiver to your radio.

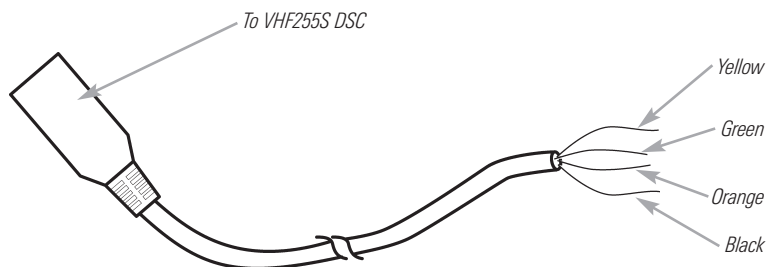

1. Line up the arrow on the connector with the arrow on the GPS cable (supplied) and then plug together. Connect the yellow and the green wires from the GPS cable to the appropriate NMEA 0183-compatible GPS Receiver as indicated by the following pinouts and your GPS Receiver Operations Manual. The GPS cable has 8 pins with the following functions:

Pin	Wire	Function
1	Red	Not used.
2	Orange	NMEA OUT (+)
3	White	Not used
4	Yellow	NMEA IN (+) from GPS Receiver
5	Green	NMEA IN (-) from GPS Receiver
6	Black	NMEA OUT (-)
7	Blue	Not used
8	Grey	Not used

NMEA 0183 Version (1.5 to 3.0) sentence format: GLL, GGA, RMS, GNS, DSC, DSE.

NOTE: Never short wires, as doing so may damage your radio or your boats power system.

NOTE: The orange and black leads are the VHF255S radio's NMEA 0183-compatible output. When a DSC call is received, these outputs will return the DSC and DSE sentences as per the NMEA 0183 standard. This connection is typically used with chartplotting or similar equipment.

USING YOUR VHF255S

Before you use your radio for the first time, you should make sure that you are familiar with the following FCC radio frequency (RF) and licensing requirements. See *Before You Use Your Radio: FCC Radio Frequency (RF) Compliance Requirements*, *Before You Use Your Radio: FCC Licensing Requirements* and *Before You Use Your Radio: FCC Privacy and Priority Channel Requirements* for more information.

You should be familiar with the following operating procedures:

1. Turning the power on/off.
2. Adjusting Squelch.
3. Selecting a channel.
4. Selecting high/low power.
5. Transmitting and receiving.
6. Selecting the U.S./International/Canadian bands.
7. Selecting a weather channel and turning on Weather Alert.
8. Accessing the 16/9 priority channels.
9. Adding/deleting channels to/from memory.
10. Accessing channels saved to memory.
11. Using the Transmit Time-Out Timer (TOT)
12. Scanning.
13. Using the Watch monitor modes.
14. Digital Selective Calling (DSC), including distress, All Ships and Group calls.
15. Making a distress call.
16. Making individual routine calls.
17. Receiving calls.
18. Resetting the radio.
19. Position and time indication.

BEFORE YOU USE YOUR RADIO: FCC RADIO FREQUENCY (RF) COMPLIANCE REQUIREMENTS

WARNING: *The radio operator and any bystanders should be at least 3.3 feet (1 meter) from the base of the antenna when the radio is transmitting (whenever the PTT key is pressed and held or anytime the TX icon appears on the LCD) in order to avoid excessive radio frequency (RF) exposure (as defined by the FCC).*

WARNING: *Hold the microphone handset no closer than 1 inch (2.5 cm) from your mouth when the radio is transmitting (whenever the PTT key is pressed and held or anytime the TX icon appears on the LCD) in order to avoid excessive radio frequency (RF) exposure (as defined by the FCC).*

WARNING: *Do not operate the radio when the antenna is not attached, in order to avoid damaging the radio and in order to avoid excessive RF exposure (as defined by the FCC).*

BEFORE YOU USE YOUR RADIO: FCC LICENSING REQUIREMENTS

Besides getting a Maritime Mobile Service Identity (MMSI) number assigned (see ***Maritime Mobile Service Identity (MMSI)*** for more information), you may need to obtain a radio operator's permit and/or station license from the FCC. You will NOT need to obtain an FCC license if:

- You are a recreational boater who will NOT be traveling to a foreign country (foreign countries include Canada and Mexico) and will not be using your radio to communicate with foreign coast or ship stations. For more information, see <http://wireless.fcc.gov/marine/>.

You WILL need to obtain an FCC license if:

- You are a recreational boater who WILL be traveling to a foreign country (foreign countries include Canada and Mexico) or will be using your radio to communicate with foreign coast or ship stations or are required to carry a radio for safety purposes; in this case, you will need to obtain a Restricted Radiotelephone Operator's Permit from the FCC (see <http://wireless.fcc.gov/marine/> for more information). In this case, anyone may talk over the radio as long as the licensed operator initiates, supervises, and ends the call.
- You are planning to operate a ship station; in this case, you will need to obtain a Ship Station License from the FCC (see <http://wireless.fcc.gov/marine/> for more information).

BEFORE YOU USE YOUR RADIO: FCC PRIVACY AND PRIORITY CHANNEL REQUIREMENTS

WARNING: You must monitor Channel 16 (the main priority and distress channel) when you are not using any other channel on the radio. See 8. Accessing the Priority 16/9 Channels for more information.

WARNING: Information overheard but not intended for the listener may NOT be used in any way, by law.

WARNING: Making a false distress call using your radio is prohibited by law. Violators can face felony charges, prosecution, significant fines, and/or incarceration. See <http://wireless.fcc.gov/marine/> for more information about privacy and priority channel usage requirements.

WARNING: Using indecent or profane language during radio transmissions is prohibited by law, Violators could face prosecution and significant fines. See <http://wireless.fcc.gov/marine/> for more information about privacy and priority channel usage requirements.

1. TURNING THE POWER ON/OFF

Use the PWR/VOL knob to turn the radio on, and once on, to adjust the volume as well.

CAUTION: Transmitting without an antenna may damage the radio or pose a health hazard. After the radio has been installed, make sure the power supply and antenna are both properly connected before powering up the radio.

To turn on the radio:

1. Rotate the PWR/VOL knob to turn the radio on or off. The knob will make a clicking noise when you have turned the radio on (or off).
2. Once on, rotate the PWR/VOL knob back and forth to adjust the volume.

2. ADJUSTING SQUELCH

Squelch is used to eliminate static and background noise between received transmissions. Squelch effectively mutes the radio speaker until it receives a transmission, thus sparing you from having to listen to static. If Squelch is set too high, only the strongest transmissions can be heard, and if it is set too low, intermittent static and noise may be annoying. Squelch is controlled by the SQUELCH knob located on the radio base station.

To set Squelch:

1. Turn the SQUELCH knob counter-clockwise as far as it will go. You will hear a lot of static.
2. Then turn the SQUELCH knob clockwise until the static stops; this is the correct position for the SQUELCH knob.
3. Repeat steps 1 and 2 to re-adjust as necessary.

3. SELECTING A CHANNEL

Use the Up/Down key on the microphone handset or the CH/ENTER knob on the radio base station to scroll through the available channels. See **Marine Channels** for a list of channels and their frequencies.

To select a channel:

1. To select a channel, use the Up/Down key on the microphone handset or turn the CH/ENTER knob on the radio base station back and forth to find a channel. Stop when you find the desired channel.

NOTE: *The channels you see will depend on which band you are in and whether you are in Memory or Normal mode. In Memory mode (MEM), you will only see the saved channels. See 10. Accessing Channels Saved to Memory for more information. If you wish to return to Normal Channel mode, press and hold the HI/LO/MEM key for 3 seconds, or press and release the CANCEL/WX key.*

4. SELECTING HIGH/LOW POWER

You must press and release the HI/LO key on the microphone handset or the HI/LO/MEM key on the radio base station to toggle the transmit power between High and Low. Select HI (High Power Transmit) for long-range communications, and LO (Low Power Transmit) for shorter-range communications to save battery power.

To change the transmit power:

1. Press the HI/LO key on the microphone handset or the HI/LO/MEM key on the radio base station to toggle between High and Low transmit power. When the radio is operating at high power, the HI icon appears on the LCD, and when operating at low power, the LO icon appears on the LCD.

5. TRANSMITTING AND RECEIVING

Press and hold the Push-To-Talk (PTT) key on the microphone handset to transmit (speak) and release the PTT key to receive (listen) on the selected channel.

To transmit and receive:

1. Press and hold the PTT key, then speak into the microphone handset to transmit. The TX icon will appear on the LCD while you are transmitting.
2. Release the PTT key to listen.

***NOTE:** Before transmitting, make sure that the channel you have selected is not a receive-only channel.*

6. SELECTING U.S./INTERNATIONAL/CANADIAN BANDS

When operating in U.S. waters, your radio should be set for the U.S. band; when operating in Canadian waters, the radio should be set for the Canadian band; when operating in International waters, the radio should be set for the International band.

To select a band:

1. To select a band, press the BAND/SAVE key. The LCD will display the U, I or C icon (for U.S., International, or Canadian bands, respectively). Press the BAND/SAVE key again to proceed to the next band, and repeat this until the desired band is displayed.

7. SELECTING A WEATHER CHANNEL AND TURNING ON WEATHER ALERT

The U.S. National Oceanic and Atmospheric Administration (NOAA) broadcasts continuous weather reports and severe weather alerts during severe weather events. Your Humminbird® VHF255S is programmed to receive all NOAA weather channels.

If Weather Alert Mode is enabled, the ALT icon will appear on the display beside the WX icon, and then, if there is a weather emergency, your VHF255S radio will sound an alert and you should press any key to hear the Severe Weather Warning from NOAA. See *U.S. Marine Channels* for a list of NOAA channels and their frequencies.

To enter Weather mode and select a weather channel:

1. Press and hold the CANCEL/WX key for 3 seconds to enter Weather mode. The WX icon will appear on the LCD, and the channel will switch to the last selected weather channel.
2. Press the Up or Down Channel keys on the microphone handset or rotate the CH/ENTER knob back and forth to change the WX channel from 1 through 10.
3. Press and release the CANCEL/WX key again to exit Weather mode.

To enable Weather Alert mode:

1. While in Weather Mode, press and hold the CANCEL/WX key for 3 seconds to enter Weather Alert mode. The ALT icon will appear on the LCD to the right of the WX icon.
2. While in Weather Mode, press and hold the CANCEL/WX key again for 3 seconds to turn off Weather Alert mode. The ALT icon will disappear from the LCD.
3. If Weather Alert mode is turned on and a weather alert tone (1050 Hz) is broadcast from a NOAA weather station, your VHF255S will pick it up automatically and will sound an alert. Press any key to hear the weather alert voice message.
4. Press and release the CANCEL/WX key again to return to normal operation.

***NOTE:** Weather broadcasts originate only in the United States and can only be heard within and near the borders and territorial waters of the United States.*

***NOTE:** During Weather mode, the PTT, SCAN, HI/LO and HI/LO/MEM keys are disabled and an error beep will sound if they are pressed.*

8. ACCESSING THE 16/9 PRIORITY CHANNELS

Channel 16 is the universal distress and emergency channel and Channel 9 is a secondary distress and emergency channel used by the U.S. Coast Guard. Use Channel 16 to establish initial contact with another station for emergency communications. The FCC requires you to monitor Channel 16 even when you do not actively need to use it, and whenever you are not using another channel on the radio to transmit or receive. Dual Watch mode allows you to monitor Channel 16 while standing by. See section **13. Using the Watch Monitor Modes** to learn more about these features.

To access the 16/9 channels:

1. Press and release the Channel 16/9 Priority key to access Channel 16.
2. To access the alternate Channel 9, which is monitored in some areas, press and hold the Channel 16/9 Priority key for 3 seconds, then release.
3. To return to your previous channel from Channel 9, press the 16/9 key twice and release. To return to your previous channel from Channel 16, press and release the 16/9 key once.

9. ADDING/DELETING CHANNELS TO/FROM MEMORY

Your VHF255S can store any channel. The stored channels are the ones scanned in the Memory Scan mode.

To add channels to memory:

1. During normal operating mode, use the Up or Down Channel keys on the microphone handset or the CH/ENTER knob on the radio base station to select the desired channel.
2. Press and hold the BAND/SAVE key for 3 seconds. The  icon will appear, indicating that the current channel has been saved in memory. Any number of channels can be saved as memory channels by repeating steps 1 and 2.

To delete channels from memory:

1. During Normal or Memory mode, use the Up or Down Channel keys on the microphone handset or the CH/ENTER knob on the radio base station to select the saved channel you wish to delete.
2. Press and hold the BAND/SAVE key for 3 seconds. The selected channel will be deleted from memory, and the  icon will disappear from the LCD.

10. ACCESSING CHANNELS SAVED TO MEMORY

Once channels have been saved, you can easily access them using the following procedure. Once in Memory mode, only the channels saved to memory will be accessible using the Up or Down Channel keys on the microphone handset or the CH/ENTER knob and the SCAN key on the radio base station.

To access saved channels:

1. Press and hold the HI/LOW/MEM key for 3 seconds, then release. The M icon will appear on the LCD to indicate that you are in Memory mode.
2. To scroll through saved channels, use the Up or Down Channel keys on the microphone handset or the CH/ENTER knob on the radio base station. To scan saved channels, press and release the SCAN key on the radio base station. For more information, see *12.Scanning*.
3. Press the CANCEL/WX key or press and hold the HI/LOW/MEM key for 3 seconds and release to exit Memory mode and regain access to all channels.

11. USING THE TRANSMIT TIME-OUT TIMER (TOT)

When the Push-to-Talk (PTT) key on the microphone handset is held down, transmit time is limited to 5 minutes. This feature helps you to avoid unintentional transmissions. About 10 seconds before automatic transmitter shutdown, you will hear a warning beep from the speaker(s). When the Transmit Time-Out Timer takes effect, the VHF255S will automatically go into receive mode. Before transmitting again, you must release and then press the PTT key once again.

12. SCANNING

Scanning is an efficient way to locate incoming transmissions quickly over a wide selection of channels or from all the channels in a frequency band. Your Humminbird® VHF255S comes with two basic scan options, Normal and Memory Scan, with the ability to add Priority Scan to each of those modes:

- **Normal Scan:** If there are no channels in memory, the default mode will be Normal Scan. In Normal Scan mode, all channels in the band are scanned in sequence (for instance, 1,2, 3, 4...). After the last channel number in the band has been scanned, the sequence repeats. Normal Scan automatically and continuously searches for transmissions on the selected band. Pressing the Up/Down Channel keys on the microphone handset or turning the CH/ENTER knob on the radio base station (clockwise = up, counterclockwise = down) will change the scan direction. If a transmission (TX icon) is received, the scan stops

on the receiving channel as long as it is present. If the signal ceases or is lost for five seconds or more, the radio resumes the scanning sequence. You can only enter Normal Scan mode when there are no channels stored in memory.

- **Memory Scan:** In Memory Scan mode, which is the default mode if any channels are stored in memory, only the channels that have been saved in memory are scanned in sequence. After the last saved channel number has been scanned, the cycle repeats.
- **Priority Scan:** In Priority Scan mode, which can be activated from either Normal or Memory Scan modes, you can scan all channels while alternately scanning Channel 16 to make sure that you don't miss distress or emergency calls (for instance, 1, 16, 2, 16, 3, 16, 4...).

Pressing the CANCEL/WX key will terminate the scan function and stop at the last scanned channel. You can also cancel the scan by pressing the 16/9 or the PTT keys.

To activate scan modes:

- 1a. Press and release the SCAN key when no channels are stored in memory to activate the Normal Scan function. The SCAN icon will appear on the LCD.

or...

- 1b. Press and release the SCAN key when there is at least one channel in memory to activate the Memory Scan function. The  and SCAN icons will appear on the LCD.

or...

- 1c. Press and release the SCAN key for 3 seconds to enter Priority Scan mode. The Priority Scan (P) icon will appear on the LCD just before the SCAN icon.
2. During any scan, pressing the Up or Down Channel keys on the microphone handset changes the scan direction, where pressing Up increases the channel number while pressing Down decreases it. You can also turn the CH/ENTER knob on the radio base station either clockwise or counterclockwise, where clockwise will increase the channel number, while counterclockwise will decrease the channel number.
3. Press and release the SCAN key to terminate the Scan mode. If you are in Priority Scan mode, you must press the SCAN key twice to exit scan mode, once to exit Priority Scan mode, and again to exit Normal Scan mode. You can also press the CANCEL/WX key to terminate Scan mode. Scan mode can also be terminated by pressing the 16/9 or the PTT keys.

NOTE: During Scan mode, the BAND/SAVE, HI/LO/MEM, and Watch keys will not function and will sound an error beep if pressed.

13. USING THE WATCH MONITOR MODES

The Humminbird® VHF255S is equipped with two types of monitor modes: Dual Watch and Tri Watch.

Dual Watch monitors the current working channel and Channel 16 alternately. Tri Watch monitors Channel 16, Channel 9 and the current working channel. Both watch modes also monitor for weather alerts when Weather Alert mode has been enabled.

To activate and terminate Dual Watch mode:

1. Press and release the WATCH key to activate the Dual Watch mode. The DU icon will appear on the LCD.
- 2a. Press and release the WATCH key again to terminate Dual Watch mode and return to the previous working channel. To quit Dual Watch mode, you can also press the 16/9, DSC/MENU or the CANCEL/WX keys. Press the PTT key to enter transmit mode on the current channel.

or...

- 2b. Press and hold the WATCH key for 3 seconds to terminate Dual Watch mode and enter into Tri Watch mode. The TRI icon will appear on the LCD.

NOTE: During Dual Watch mode, the SCAN, HI/LO/MEM, BAND/SAVE, and the Up and Down Channel keys are inactive and will sound an error beep if pressed.

To activate and terminate Tri Watch mode:

1. Press and hold the WATCH key for 3 seconds to activate the Tri Watch mode. The TRI icon will appear on the LCD.
- 2a. Press and hold the WATCH key again for 3 seconds to terminate Tri Watch Mode and to return to the previous working channel. To quit Tri Watch mode, you can also press the 16/9, DSC/MENU or the CANCEL/WX keys. Press the PTT key to enter transmit mode on the current channel.

or...

- 2b. Press and release the WATCH key to terminate Tri Watch mode and enter into Dual Watch mode. The DU icon will appear on the LCD.

NOTE: During Tri Watch mode, the SCAN, HI/LO/MEM, BAND/SAVE, and the Up or Down Channel keys are inactive and will sound an error beep if pressed.

14. DIGITAL SELECTIVE CALLING (DSC)

DSC (Digital Selective Calling) is a semi-automated method of establishing a radio call that has been designated by the International Maritime Organization (IMO) as an international standard for establishing VHF, MF and HF radio calls. It has also been designated part of the Global Maritime Distress and Safety System (GMDSS). This new service allows you to initiate or receive distress, urgency, safety and routine calls to or from another vessel equipped with a DSC transceiver.

NOTE: *You will need to have a Maritime Mobile Service Identity (MMSI) assigned to you and entered into the radio before Digital Selective Calling features will work. Refer to the **Maritime Mobile Service Identity (MMSI)** and the **DSC Setup, Enter Your User MMSI** sections for more information.*

NOTE: *You will also need to have an optional-purchase GPS Receiver attached in order to take full advantage of the DSC features of your radio.*

WARNING: *This radio is designed to generate a digital maritime distress and safety call to facilitate search and rescue. To be effective as a safety device, this equipment must be used only within communication range of a shore-based VHF marine Channel 70 distress and safety watch system. The range of signals may vary, but under normal conditions, should be approximately 20 nautical miles.*

To select a DSC call type:

1. Press the DSC/MENU key to display the DSC Call Type List, which you will use to select the desired DSC call type by rotating the CH/ENTER knob until the desired call type is highlighted, then pressing the CH/ENTER to execute your selection.
2. Only 4 calls can be displayed on the LCD at the same time; use the Up or Down Channel keys on the microphone handset or the CH/ENTER knob on the radio base station to view all the call types, until the desired call type is selected. Use the following table to make a specific type of DSC call. (DSC Call Type choices are: LAST CALL, NEW CALL, GROUP, ALL SHIPS, CALL LOG, DISTRESS LOG, POS REQUEST, EXIT.)

DSC Call Types

- LAST CALL:** Recalls last call regardless of which type of call was received last.
- NEW CALL:** Allows you to make a new call, either by entering an MMSI number or by selecting a number from the Contact List.
- GROUP:** Sends transmissions that are only received by radios that share a common group MMSI number; up to 3 group MMSI numbers can be stored and called.
- ALL SHIPS:** Make an Urgency, Safety, or Routine call to all DSC-enabled ships or ships within communication range. A re-confirmation screen will be displayed after you choose one of these three call types. You should send an All Ships call when assistance is needed but the situation is not serious enough for a Distress Call. An Urgency call is made when assistance is required but the situation is not life-threatening, while a Safety call is for an advisory alert.
- CALL LOG:** Allows a review of the last 20 stored calls by number and time of call. An individual call type can be placed to the selected MMSI/NAME in the LOG. The LOG maintains all received call types except DISTRESS calls. The earliest call is stored at the end of the list (20 maximum), and is automatically erased when a new call comes in.
- DISTRESS LOG:** Allows a review of the last 10 stored Distress calls by number and time of call. The earliest call is stored at the end of the list (10 maximum), and is automatically erased when a new call comes in.
- POS REQUEST:** Allows you to request GPS position information from any vessel for which an MMSI number is known; you can either pick the MMSI number of the vessel from the Contact List, which is a personal DSC directory of saved MMSIs, or by manual entry.
- EXIT:** Quits the DSC Call Type menu mode.

To make an All Ships call:

1. From the DSC Call Type List, select ALL SHIPS. The following choices will be displayed: Urgency, Safety, and Routine.
2. Select one of those three choices to see another submenu that gives you the choice to Send or Cancel the All Ships call type. Press the CH/Enter knob again to send the call type selected, or press the 16/9 key to quit.
3. Once the call is sent, the text area of the LCD will momentarily show the Calling All Ships message. The radio will then return to normal VHF operation on Channel 16 with high power, except ROUTINE. Press PTT to talk.

To make a Group call:

This feature allows you to contact a group of specific vessels using DSC and to switch to a desired channel automatically. Before sending a GROUP call, you must set the GROUP MMSI.

1. From the DSC Call Type List, select GROUP. The names of your groups will be displayed.
2. Select the group that you want to call, then select the channel. Press the CH/ENTER knob to send the group call. Once the call is sent, the Text area of the LCD will momentarily show the Calling group message.
3. Once the group call is sent, the radio will return to normal VHF with the designated channel. Press PTT to talk.

15. MAKING A DISTRESS CALL

The DISTRESS key is used to make a Distress call. A Distress call will send out the position and time information from the input NMEA data along with your MMSI number. This digital information lets other ships and shore stations equipped with appropriate DSC equipment know where you are and that you are in a distress situation.

WARNING: Unless you need immediate help, NEVER use the DISTRESS key. Making a false distress call using your radio is prohibited by law. Violators can face felony charges, prosecution, significant fines, and/or incarceration.

NOTE: You can only initiate a Distress call when you have a MMSI assigned to your radio and you have DSC enabled. See the **Maritime Mobile Service Identity (MMSI)** section for more information.

NOTE: Making one or more Distress calls creates a Distress Log. You can access the Distress Log through the DSC Call Type List.

NOTE: For more information about using your radio in a distress situation and how to comply with Coast Guard regulations, refer to <http://www.navcen.uscg.gov/marcomms/>. Refer to the FCC website: <http://wireless.fcc.gov/marine/> for general and technical VHF Marine Radio license, specifications, and regulation information.

1. Open the red cover over the DISTRESS key.
2. Press the DISTRESS key momentarily. The text area of the LCD will reconfigure to show the Distress submenu, shown below:

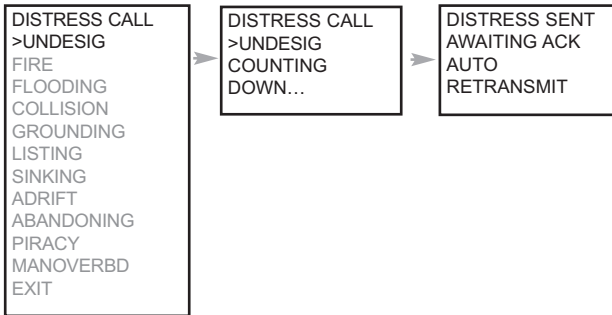

3. If you have enough time, rotate the CH/ENTER knob to select the type of Distress call.
4. Hold down the DISTRESS key for more than 3 seconds, until you see the DISTRESS CALL SENT message on the LCD. The entire LCD will flash and beep loudly.

NOTE: If you release the DISTRESS key before 3 seconds have passed, the Distress call will not be sent; if you hold down the DISTRESS key for more than 3 seconds, the Distress call will be sent whether channel 70 is busy or not. When a Distress call is sent, the acoustic alert sounds as a continuous tone until acknowledgement is received or you cancel the Distress call.

5. During the distress call sequence, the radio simultaneously watches Channel 70 (for a DSC acknowledgement) and Channel 16.
6. When the distress call is acknowledged, the acoustic alert will stop and the radio will return to normal operation on Channel 16, with high transmit power set.
7. If no acknowledgement is received, the unit continues to transmit the distress call at random intervals of 3.5 to 4.5 minutes until a response is received or the call is manually cancelled (by pressing the CANCEL/WX key for two seconds). In an emergency situation, when there is no DSC response, you should make manual MAYDAY distress calls between the automatic DSC calls as described in the next step.
8. Make sure that the radio's transmit power is set to High by pressing the HI/LOW/MEM key if necessary.
9. Press and hold the PTT key and speak slowly, clearly, and calmly into the microphone and communicate the following information:
 - MAYDAY MAYDAY MAYDAY.
 - This is [name of your vessel, spoken three times and your call sign or boat registration number, spoken once].
 - Repeat MAYDAY and [your ship's name], spoken once.
 - Describe where you are, providing latitude or longitude, or by bearing (true or magnetic, state which) and any information such as distance to nearby landmarks. Include any information on vessel's course, speed and destination.
 - Describe the nature of your distress (FIRE, FLOODING, COLLISION, GROUNDING, LISTING, SINKING, ADRIFT, ABANDONING, PIRACY, MANOVERBD).
 - Describe the kind of assistance required.
 - Provide the number of people onboard.
 - Provide any additional information that may facilitate your rescue, such as the current condition of your vessel, your vessel's size, color, hull type, number of people onboard needing medical attention.
 - Say that you will be monitoring Channel 16.
 - End your distress message by saying "This is [your ship's name/call sign] OVER."

10. Release the PTT key and listen for a response. If you do not get a response, repeat step 9 until you do.
11. If you must abandon ship without receiving a response, and you have time, go back to step 1, and initiate an automatic distress call that will broadcast the ABANDONING message.

16. MAKING INDIVIDUAL ROUTINE CALLS

You can make an individual call, either to a ship or to a coast station.

To send an individual, manual call:

1. From the DSC Call Type List, select NEW CALL. The New Call submenu will be displayed, and the arrow will point to MANUAL.
2. Press the CH/ENTER knob again to display the ENTER MMSI screen. Enter the MMSI number using the CH/ENTER knob; when MMSI entry is complete, press the CH/ENTER knob to enter it.
3. Then rotate the CH/ENTER knob to select the working channel (the channel on which you want to be called back) and press the CH/ENTER knob to enter it. The working channel will show up in the Acknowledge message of the called radio.
4. The radio summarizes the call details and asks for confirmation to send the call by displaying >SEND on the LCD. (You must confirm many of the DSC commands before the radio will execute them.)
5. Press the CH/ENTER knob again to send the call. The radio goes to Channel 70 and the TX icon is displayed on the screen while the DSC call is being sent, then the LCD displays an awaiting acknowledgment message. If you wish to cancel the call, rotate the CH/ENTER knob until >CANCEL is highlighted, then press the CH/ENTER knob again to cancel the call or press and release the 16/9 key.
- 6a. If the call is acknowledged, press PTT to talk.

or...

- 6b. If the call is not acknowledged within 16 seconds, the radio will prompt you to resend the call.
7. If you do nothing for 5 minutes, the individual call will be cancelled and the radio will revert to the original channel selected before you started the individual call.

To send an individual call using an MMSI stored in the Contact List:

1. From the DSC Call Type List, select NEW CALL. The NEW CALL submenu will be displayed, and the cursor will point to MANUAL; any MMSI names stored in your Contact List will also appear. If you have no names stored in your Contact List, you will not be able to proceed. (See Setup Menu, Contact List for more information.)
2. Rotate the CH/ENTER knob select the MMSI number of the person from the Contact List that you want to call, then press the CH/ENTER knob again to initiate the call.
3. Then rotate the CH/ENTER knob to select the desired reply channel and press the CH/ENTER knob to enter it. The radio goes to CH 70 and the TX icon is displayed on the screen while the DSC call is being sent, then LCD displays an awaiting acknowledgment message.
- 4a. If the call is acknowledged, press PTT to talk.

or...

- 4b. If the call is not acknowledged within 16 seconds, the radio will prompt you to resend the call.
5. If you do nothing for 5 minutes, the individual call will be cancelled and the radio will revert to the original channel selected before you started the individual call.

Sending an individual call using the Call Log:

The Call Log contains the contact details for the 20 most recent incoming calls, so that you can call any of them again quickly.

1. Press the DSC/MENU key to enter DSC mode, select CALL LOG, press the Up or Down Channel keys on the microphone handset or the CH/ENTER knob on the radio base station to scroll for previous calls. The END OF LOG message will indicate the end of the Call Log list.
2. Press the CH/ENTER key to initiate the call.
3. Then rotate the CH/ENTER knob to select the desired reply channel and press the CH/ENTER knob to enter it. The radio goes to CH 70 and the TX icon is displayed on the screen while the DSC call is being sent, then LCD displays an awaiting acknowledgment message.
- 4a. If the call is acknowledged, press PTT to talk.

or...

- 4b. If the call is not acknowledged within 16 seconds, the radio will prompt you to resend the call.
5. If you do nothing for 5 minutes, the individual call will be cancelled and the radio will revert to the original channel selected before you started the individual call.

NOTE: To save this Call Log entry in your Contact List, select **SAVE**, then press the **CH/ENTER** key and enter a screen name to represent how the logged MMSI is displayed on the LCD. Turn the **CH/ENTER** knob to find each character, then press the **CH/ENTER** knob to select each character.

17. RECEIVING CALLS

When you have an incoming call, the radio will ring to alert you to the call. If you miss a call, the blinking  icon will appear on the LCD, and will remain until you read your missed message in the Call Log.

To acknowledge an individual incoming call:

The radio either automatically or manually sends an acknowledgement to the requesting radio, depending on its configuration settings. In the U.S. band, an acknowledgement will be sent to the requesting radio within 10 seconds of receiving the call.

To recall the most recent incoming call (last call):

1. From the DSC Call Type List, select **LAST CALL**. The details of the last call will be displayed.
2. Select the working channel for an individual call and press the **CH/ENTER** key. The radio will summarize the call details and ask for confirmation to send the call. Press the **CH/ENTER** knob again to send the call.

To receive a DSC call:

1. When a DSC call is received, the radio automatically responds based on the type of call. The information displayed on the LCD varies depending upon the call type. See **Section 14, Digital Selective Calling**, for a list of Call Types.

To receive a Distress call:

1. When a distress call is received, the radio automatically tunes to Channel 16, and the Distress alert tone sounds. The call data is stored in the Distress Log. Pressing any key disables the alert.

- When position data is included within the signal, it is displayed in the Text area of the LCD. When no position data is included within the signal, the message "99° „99.9999X, 999° „99.9999Y" is displayed in the Text area of the LCD.
- You must continue to monitor channel 16 as a coast station may require assistance in a rescue attempt.

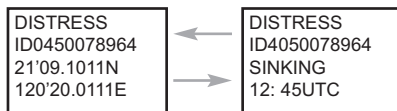

To receive a Distress acknowledgement sent from a coast station:

- When a Distress Acknowledge Call is received, the radio automatically tunes to Channel 16, and the Distress Alert Tone sounds. Pressing any key disables the alert. When position data is included within the signal, it is displayed in the Text area of the LCD. The call data is stored in the Distress Log.
- You must continue to monitor Channel 16, as a coast station may require assistance in a rescue attempt.

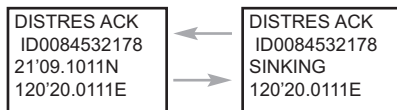

To receive a Distress Relay call:

- When a Distress Relay call is received, the radio automatically tunes to Channel 16, and the Distress alert tone sounds. Pressing any key disables the alert. The call data is stored in the Distress Log. When position data is included within the signal, it is displayed in the Text area of the LCD.
- You must continue to monitor Channel 16, as a coast station may require assistance in a rescue attempt.

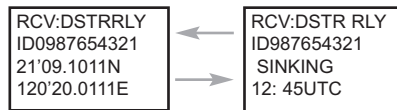

To receive an All Ships call:

- When an All Ships call is received, an alert sounds, and the radio automatically tunes to the designated channel. Press any key to disable the alert.

2. You must continue to monitor the channel in order to receive the voice communication.
3. The call data is stored in the Call Log.



To receive a Group call:

1. When a Group call is received, an alert sounds, and the radio automatically tunes to the designated channel. Press any key to disable the alert.
2. Monitor the designated channel for an announcement from the calling ship.
3. The call data is stored in the Call Log.

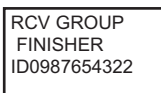

To receive an Individual call:

1. When an Individual call is received, an alert sounds. The radio automatically tunes to the channel designated in the DSC signal.
2. The MMSI contained within the signal is displayed in the Text area of the display. If the MMSI matches an MMSI stored in the Contact List, the name associated with it is displayed in place of the MMSI.
3. The DSC signal data is stored in the Call Log.

To receive a Position Reply call:





1. When Position Reply is received, the Alert tone will sound and the POS Received message and the sender GPS data will be displayed.
2. Last received call information is stored in the LAST RX position in the Call Log.

To receive a Geographic Area call:

A Geographic Area call is received by vessels within a specific geographical area.

1. When you receive notification of an incoming geographic area call, press any key to cancel the alert. The radio automatically selects the channel designated in the incoming call. The time and the user MMSI are displayed on the screen and the call data is stored in the Call Log.
2. Monitor the working channel for an announcement from the calling vessel.

To acknowledge a missed call:

1. If you miss a call, the blinking  icon will appear on the LCD, and will remain until you go to the Call Log and scroll through all the messages to find the missed calls, which will have  icons next to them. Scroll through all the messages with  icons in order to acknowledge them. Once you have done this, the blinking  icon will disappear from the LCD.

18. RESETTING THE RADIO

You can reset many radio settings, including almost all user settings, back to the factory default settings. Resetting the radio will:

- Erase any channels stored in memory.
- Turn Off the Weather Alert setting, if it is currently active.
- Return power settings to their original state.

***NOTE:** Resetting the radio will NOT erase the MMSI setting, nor will it delete your Contact List, and it will also keep you in the band (U, I, or C) that you had selected before reset.*

To reset the radio:

1. Press and hold the DSC/MENU key to display the Setup Menu.
2. Use the CH/ENTER knob on the radio base station or the Channel Up and Down keys on the microphone handset to select RESET, and then press the CH/ENTER knob. The radio will reset after 5 seconds.
3. Select EXIT from the menu, or press either the CANCEL/WX or the 16/9 key to return to Normal mode.

19. POSITION INDICATION

Your VHF255S can display the position of the vessel (longitude and latitude) as well as time and date information, if connected to a GPS receiver; if no GPS receiver is connected, an alert tone of 1-minute duration (which can be cancelled by pressing any key) sounds at 4-hour intervals to encourage manual input of positional data. After no manual position input has been made for 24 hours, the NO POS DATA message is replaced with a NO GPS message, and the position and time data displayed changes to all 9s and all 8s, respectively.

DISTRESS 23°20.1234 N 100°15.1002 E 08:10PM UTC
--

To request the Lat/Lon position of an MMSI (POS request):

This option allows you to request GPS position information from any vessel for which an MMSI number is known.

1. From the DSC Call Type List, select POS REQUEST, then select either LAST RX or CONTACTS.
- 2a. If you selected LAST RX, pressing the CH/ENTER knob will allow you to send the call. Skip to step 3.

or...

- 2b. If you selected CONTACTS, the Contact List will be displayed. Select a contact for which you want position information. Rotate the CH/ENTER knob to select the MMSI number of the person from the Contact List for which you want position information, then press the CH/ENTER knob again to initiate the request.
3. The radio switches to CH 70 and the TX icon is displayed while the position request is being sent, then the awaiting acknowledgment message will be displayed.
- 4a. If the call is acknowledged, the position data is displayed, and an alert will sound.

or...

- 4b. If the call is not acknowledged within 16 seconds, the radio will prompt you to resend the call.
5. If you do nothing for 5 minutes, the position request will be cancelled and the radio will revert to Normal mode.

Position Reply: The position reply can be used to send your position to another radio when your radio has an operating GPS receiver connected. The position reply feature can either prompt you to send your position manually or do it automatically, depending on your DSC Setup configuration.

SETUP MENU

The radio's setup functions are accessed through the Setup Menu. Setup Menu selections are as follows:

CONTACTS
LOCAL/DIST
BACKLIGHT
CONTRAST
GPS/TIME
RADIO SETUP
DSC SETUP
RESET
EXIT

CONTACTS: Selects the Contact List Entry routine to enter Names and MMSI numbers for frequently-called DSC stations. Up to 20 Contact Names can be stored.

LOCAL/DIST: DIST (Distant) allows normal receive sensitivity, while LOCAL eliminates receiver noise, but degrades receiver sensitivity. Only Local mode has an icon, the LOCAL icon.

BACKLIGHT: Sets the backlight level; 8 total levels are available.

CONTRAST: Selects the display contrast setting; 8 levels of contrast are available.

GPS/TIME: Allows you to manually set position and time data if no GPS is attached, and defines if and how position and time data, time offset, and COG/SOG settings are displayed.

RADIO SETUP: There are 4 items that you can customize: CH Name, Ring Tone Volume, Beep Volume and Internal Speaker on/off.

DSC SETUP: There are 5 functions that you are allowed to alter: User MMSI entry, Group MMSI entry, Individual Reply, DSC enable, and POS reply.

RESET: This resets almost all settings to factory defaults.

EXIT: This provides another way to exit the Setup Menu.

***NOTE:** During Setup operation, TX and RX are disabled.*

To access the Setup Menu:

1. Press and hold the DSC/MENU key for 3 seconds; the Text area on the LCD will display the Setup Menu list. (Setup Menu choices are: CONTACTS, LOCAL/DIST, BACKLIGHT, CONTRAST, GPS/TIME, RADIO SETUP, DSC SETUP, RESET, EXIT.)
2. Rotate the CH/ENTER knob to select an Item within the Setup Menu list. To confirm a selected item, push the CH/ENTER knob. When you have selected the desired setting, press the CH/ENTER knob to enter it, and return to the Setup Menu list.

NOTE: To exit the Setup Menu or one of the submenus, either press the 16/9 key or select the EXIT option from the menu (to exit out of all submenus) or press the CANCEL/WX key (to step back one menu level). You can also exit the Setup Menu by turning the unit off. All changes are saved in EEPROM (except for manually-entered GPS data).

CONTACT LIST

The Contact List can store up to 20 entries with Name and MMSI number. You can add, edit or delete the record from the list under this submenu.

To add an entry to the Contact List:

1. From the Setup Menu, select CONTACTS. Move the cursor to NEW and press the CH/ENTER knob to display an entry page which prompts you to enter the new Contact Name and MMSI.
2. Rotate the CH/ENTER knob to select the first desired character (A-Z, 1-9, space and back arrow "<") for the name. When the desired character is shown, press the CH/ENTER knob to select it; continue to select characters for the Contact Name in this way; up to 11 characters in all may be selected. When the last digit is entered, you will be automatically advanced to the first MMSI digit.

NOTE: You can enter alphanumeric and symbol characters for the Contact Name, but some may be spaces; turn the CH/ENTER knob one click counterclockwise to remove a _ and replace it with a blank space, then press the CH/ENTER knob once more to select it and move to the next character.

3. Enter the MMSI number associated with that Contact Name. Once you have entered all 9 digits, a confirmation message will appear to ask you if you want to save the Contact.

- 4a. Press the CH/ENTER knob to save the new Contact, which will be displayed at the top of the Contact List.

or...

- 4b. Press the CANCEL key to terminate the process without saving, then go back to the Contact List screen.
5. When the Contact List is full (has 20 entries), you cannot add a new entry until you have deleted an existing entry.

To edit an existing Contact List entry:

1. From the Setup Menu, select CONTACTS. Rotate the CH/ENTER knob to highlight a specific Contact Name and press the CH/ENTER knob to see the EDIT and DELETE choices for the selected Contact Name and associated MMSI. Choose EDIT.
2. When you are finished editing, press the CH/ENTER knob . You will be prompted to save your changes.
3. Press the CH/ENTER knob again to save your edits. The Contact List is displayed again. If more changes are required, repeat steps 1 through 3; otherwise, press the CANCEL/WX key to exit.

To delete an entry from the Contact List:

1. From the Setup Menu, select CONTACTS. Rotate the CH/ENTER knob to highlight a specific Contact Name and press the CH/ENTER knob to see the EDIT and DELETE choices for the selected Contact Name and associated MMSI. Choose DELETE.
2. Press and hold the CH/ENTER knob to confirm your changes. The Contact List will be displayed again.
3. If you need to delete more Contact Names, repeat steps 1 through 2; otherwise, press the CANCEL/WX key to exit.

LOCAL/DISTANT

You can set the receiver to LOCAL to eliminate noise, as the LOCAL setting limits radio reception to strong signals only.

To set the receiver to Local/Distant:

1. From the Setup Menu, select LOCAL/DIST, then choose LOCAL and press the CH/ENTER knob to set the receiver to Local. The LOCAL icon will appear on the LCD.
2. Select LOCAL/DIST from the Setup Menu list, then choose DISTANT and press the CH/ENTER knob to set the receiver to DISTANT.

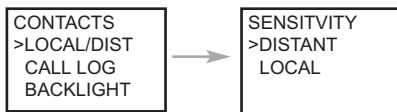

BACKLIGHT ADJUSTMENT

You can adjust the backlight on the LCD to adapt to changing light conditions.

To adjust the backlight:

1. From the Setup Menu, select BACKLIGHT. There are 8 levels of control for the Backlight. The lower levels are for a dimmer backlight, while the higher levels are for a brighter backlight.
2. Rotate the CH/ENTER knob to adjust the setting, Press the CH/ENTER knob to enter the setting and return to the Setup Menu.

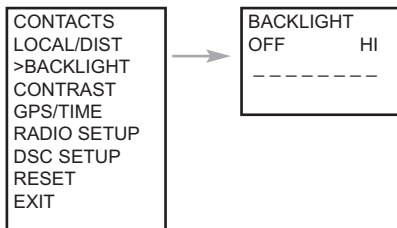

CONTRAST ADJUSTMENT

You can adjust the contrast on the LCD to adapt to changing light conditions.

To adjust the Contrast:

1. From the Setup Menu, select CONTRAST. There are 8 levels of control for the Contrast. The higher numbers represent a higher-contrast setting, while the lower numbers represent a lower-contrast setting.
2. Rotate the CH/ENTER knob to adjust the setting, Press the CH/ENTER knob to enter the setting and return to the Setup Menu List.

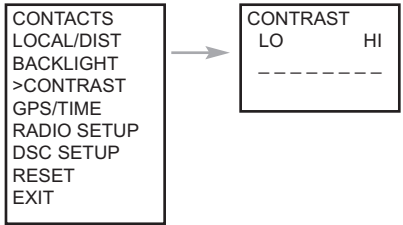

GPS/TIME SUBMENU

The radio automatically detects NMEA strings and decodes the appropriate latitude/longitude position and time. If the GPS navigation receiver is not connected or is not functional, the radio will send an alert every 4 hours to request that you enter manual GPS coordinates and time data. If you do not enter this data manually for 24 consecutive hours, the radio will stop sending the alert and will simply display NO GPS on the LCD.

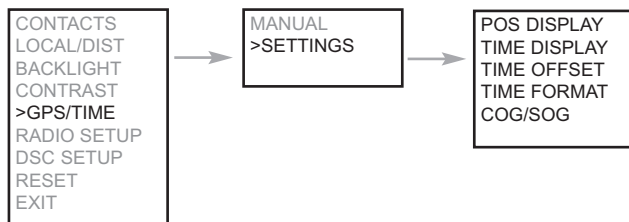

To access the GPS/Time Submenu:

1. From the Setup Menu, select GPS/TIME.
2. Rotate the CH/ENTER knob to select items within the GPS/Time Submenu. To confirm a selected item, push the CH/ENTER knob to see more Submenus. When you have selected the desired setting, press the CH/ENTER knob to enter it, and return to the GPS/Time Submenu. (GPS/Time Submenu choices include MANUAL and SETTINGS. There are additional submenu choices under SETTINGS.)

NOTE: To exit the GPS/TIME submenu or one of the submenus under it, press the 16/9 key (to exit out of all submenus, including the Setup Menu) or press the CANCEL/WX key (to step back one menu level). You can also exit the GPS/Time Submenu by turning the unit off. All changes are saved in EEPROM (except for manually-entered GPS data).

GPS/TIME SUBMENU: MANUALLY ENTER GPS DATA

If no GPS data is available, the NO GPS icon appears, and POS DATA REQ is displayed with NO GPS. An alert will sound for 5 seconds or until any key is pressed. The manual entry function is valid if and only if no GPS Receiver is connected.

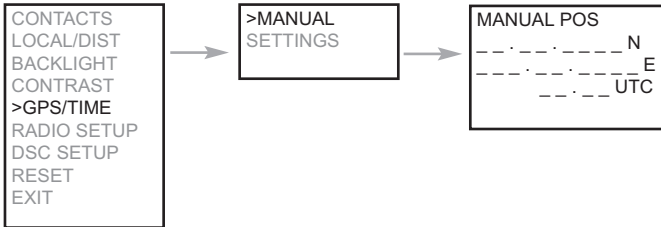

To manually enter GPS Data:

1. From the GPS/Time Submenu, select MANUAL to see the Manual Position display.
2. Enter the latitude, then the longitude, then the UTC time.
3. Press the CH/ENTER knob when all the information is correct. The boat's lat/lon with the UTC time will be shown on the LCD.

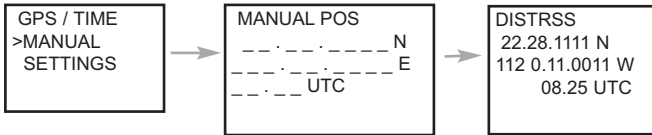

NOTE: The manual entries will be overwritten automatically if the radio is connected to an optional-purchase GPS Receiver and a new GPS position is received.

GPS/TIME SUBMENU: SETTINGS SUBMENU

The Settings Submenu under the GPS/TIME Submenu allows you to set the following information:

- Whether Position data is displayed.
- Whether the Time is displayed.
- Whether a Time Zone Offset is used.
- How the Time data is formatted.
- Whether COG/SOG data is displayed.

NOTE: If the TIME DISPLAY is turned on, COG/SOG will be turned off automatically, and vice versa, since they use the same line on the LCD.

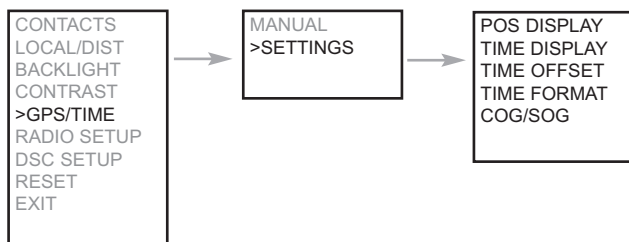

GPS/TIME SETTINGS SUBMENU: POSITION DISPLAY ON/OFF

You can choose whether or not the boat's position is displayed in Normal mode.

1. From the GPS/Time Submenu, select SETTINGS, then select POS DISPLAY to turn the Position Display ON or OFF.
2. Select ON to make the LCD display the boat's position.

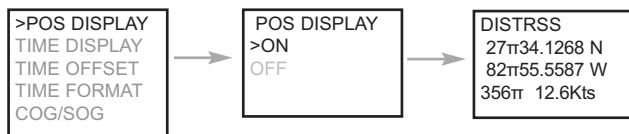

GPS/TIME SETTINGS SUBMENU: TIME DISPLAY ON/OFF

You can choose whether or not the time is displayed in Normal mode.

1. From the GPS/Time Submenu, select SETTINGS, then select TIME DISPLAY to turn the Time Display ON or OFF.
2. Select ON to make the LCD display the time, and OFF to suppress the time. In the following example, OFF is selected and the LCD no longer shows the time.

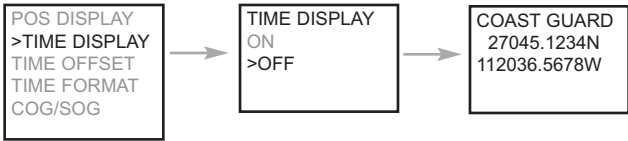

GPS/TIME SETTINGS SUBMENU: TIME OFFSET (LOCAL TIME)

You can set the time offset add/subtract value from UTC time to equal local time. When this offset value is added, the time will be displayed as LOC instead of UTC.

1. From the GPS/Time Submenu, select SETTINGS, then select TIME OFFSET to set a time offset.
2. Use the CH/ENTER knob to set the offset direction to be + or -.
3. Then use the CH/ENTER knob to set the number of hours of the offset in .5 (1/2) hour increments. The time will be updated immediately to reflect the new time offset.

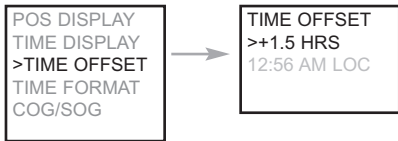

GPS/TIME SETTINGS SUBMENU: TIME FORMAT

You can choose the time display to be in either 12 hour or 24 hour format.

1. From the GPS/Time Submenu, select SETTINGS, then select TIME FORMAT to change the time format.
2. Use the CH/ENTER knob to choose either 12 HR or 24 HR, and press the CH/ENTER knob again to enter the selected time format.

NOTE: If the TIME DISPLAY is turned on, COG/SOG will be turned off automatically, and vice versa, since they use the same line on the LCD.

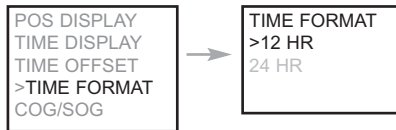

GPS/TIME SETTINGS SUBMENU: COURSE/SPEED DISPLAY OPTIONS (COG/SOG)

You can enable COG (Course Over Ground) and SOG (Speed Over Ground) to be displayed in Normal mode.

1. From the GPS/Time Submenu, select SETTINGS, then select COG/SOG to turn either COG or SOG ON or OFF using the CH/ENTER knob.

NOTE: If the TIME DISPLAY is turned on, COG/SOG will be turned off automatically, and vice versa, since they use the same line on the LCD.



RADIO SETUP SUBMENU

The Radio Setup submenu under the Setup Menu allows you to set the following information:

- The name of a channel.
- Ring volume for incoming calls.
- Beep volume for alerts.
- Whether the internal speaker is turned on or off.

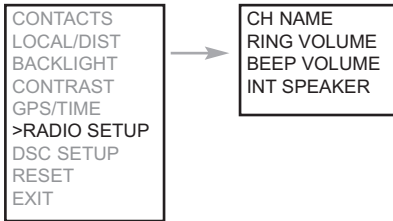

To access the Radio Setup Submenu:

1. From the Setup Menu, select RADIO SETUP to display the Radio Setup Submenu. (Radio Setup Submenu choices are: CH NAME, RING VOLUME, BEEP VOLUME, INT SPEAKER.)
2. Rotate the CH/ENTER knob to select Items within the Radio Setup Submenu. To confirm a selected item, push the CH/ENTER knob to see more submenus. When you have selected the desired setting, press the CH/ENTER knob to enter it, and return to the Radio Setup Submenu.

NOTE: To exit the Radio Setup submenu or one of the submenus under it, press the 16/9 key (to exit out of all submenus, including the Setup Menu) or press the CANCEL/WX key (to step back one menu level). You can also exit the Radio Setup Submenu by turning the unit off. All changes are saved in EEPROM (except for manually-entered GPS data).

RADIO SETUP: CHANNEL NAME DISPLAY AND EDITING

You can associate a text name with a channel, and display the name on the LCD below the channel number, or suppress the display of the name; you can also delete an existing text name.



To display an existing channel name:

1. From the Radio Setup Submenu, select CH NAME, then DISPLAY to turn the display ON or OFF using the CH/ENTER knob.

To edit an existing channel name entry:

1. From the Radio Setup Submenu, select CH NAME, then CH INFO, then press the CH/ENTER knob. The screen will display the channel number and the name associated with that channel. You can then use the CH/ENTER knob to scroll through any other channel on the band, and press the CH/ENTER knob again to edit or delete that channel name.
2. Select EDIT and press the CH/ENTER knob to edit the existing name tag, then enter the new name over the existing name and press the CH/ENTER knob to display the YES/NO confirmation message.
3. Press the CH/ENTER knob to confirm the new channel name, then press the CANCEL key to return to the previous screen.

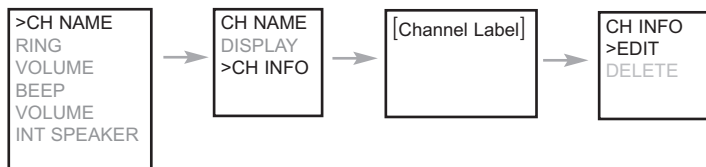

To delete a name tag from a saved channel:

1. From the Radio Setup Submenu, select CH NAME, then CH INFO, then press the CH/ENTER knob. The screen will display the channel name associated with that channel.
2. Select DELETE and press the CH/ENTER knob to see the YES/NO confirmation message. Choose YES to delete the existing channel name tag.



RADIO SETUP: RING VOLUME ADJUSTMENT

1. From the Radio Setup Submenu, select RING VOLUME to display the ringer tone option settings, and choose either LOUD or SOFT.

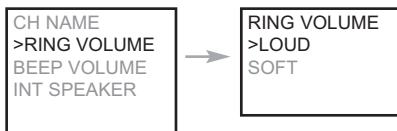

RADIO SETUP: BEEP VOLUME ADJUSTMENT

This setting allows you to set the key beep tone volume level.

1. From the Radio Setup Submenu, select BEEP VOL to display the beep volume setting choices, and choose either HIGH, LOW or OFF using the CH/ENTER knob.

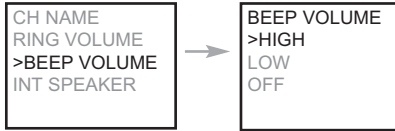

RADIO SETUP: TURNING THE INTERNAL SPEAKER ON/OFF

This setting allows you to turn the internal speaker on or off in case you are using an external speaker instead.

1. From the Radio Setup Submenu, select INT SPEAKER, and choose either ON or OFF using the CH/ENTER knob.



DSC SETUP SUBMENU

The DSC Setup submenu under the Setup Menu allows you to set the following information for the DSC/ATIS function:

- The User MMSI assigned to your radio (can ONLY be set once).
- Up to three Group Names and associated MMSIs.
- Automatic or manual individual reply.
- Whether DSC is enabled or temporarily disabled.
- Automatic, manual or off position request response.

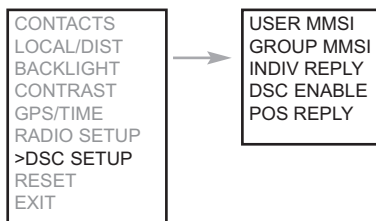

To access the DSC Setup Submenu:

1. From the Setup Menu, select DSC SETUP to display the DSC Setup Submenu. (DSC Setup Submenu choices are: USER MMSI, GROUP MMSI, INDIV REPLY, DSC ENABLE, POS REPLY.)
2. Rotate the CH/ENTER knob to select Items within the DSC Setup Submenu. To confirm a selected item, push the CH/ENTER knob to see more submenus. When you have selected the desired setting, press the CH/ENTER knob to enter it, and return to the DSC Setup Submenu.

NOTE: To exit the DSC Setup submenu or one of the submenus under it, press the 16/9 key (to exit out of all submenus, including the Setup Menu) or press the CANCEL/WX key (to step back one menu level). You can also exit the DSC Setup Submenu by turning the unit off. All changes are saved in EEPROM (except for manually-entered GPS data).

DSC SETUP: ENTER YOUR USER MMSI

NOTE: You must get an MMSI assigned to you before you can perform this procedure, and you will *ONLY* be allowed to perform this operation once. You must enter your user MMSI before you can use the DSC functions. If there is no User MMSI stored and an attempt is made to use the DSC function of the radio, the LCD will display the following message:

DSC IS NOT
OPERATIONAL
PLEASE ENTER
MMSI

The Maritime Mobile Service Identity (MMSI) number is the nine-digit number used on marine radios like your VHF255S that are capable of using Digital Selective Calling (DSC). This number is used like a telephone number to call other vessels individually and automatically. For more information on MMSIs, please see the ***Maritime Mobile Service Identity (MMSI) section.***

To obtain an MMSI assignment:

1. Contact BOAT US or SEATOW to obtain a unique MMSI number for your VHF255S radio. Go to: ***<http://www.boatus.com/mmsi/>*** or ***<http://www.seatow.com/boatingsafety/mmsiinfo.htm>*** and follow the instructions.
2. When you have obtained your unique MMSI number, write it down IMMEDIATELY in the space provided on the inside front cover of this manual.

NOTE: You should also write down the serial number (found on the left panel of the radio base station) on the inside front cover of this manual, for future reference.

To enter your assigned MMSI into your radio:

1. Press and hold the DSC/MENU key; the Text area on the LCD will display the Setup Menu list.
2. Rotate the CH/ENTER knob to select DSC SETUP from the Setup Menu list, and push the CH/ENTER knob to display the DSC Setup Submenu.
3. Rotate the CH/ENTER knob to select USER MMSI from the DSC Setup Submenu and push the CH/ENTER knob to display the USER MMSI entry screen.

NOTE: If an existing User MMSI has already been stored, it will be displayed, stop here. You **CANNOT** edit the User MMSI once it has been entered and confirmed.

- If the User MMSI is blank, a dashed line will be displayed. Turn the CH/ENTER knob back and forth to enter the User MMSI along the dashed line. Press the CH/ENTER knob to confirm each correct entry and to be advanced automatically to the next digit.

NOTE: If you make an error, press the CANCEL/WX key until < appears, then press the CH/ENTER knob to back up and correct the error.

- When you have selected the desired numbers, press the CH/ENTER knob to store your User MMSI.
- You will be asked to re-enter your User MMSI again to confirm it; once you have re-entered your User MMSI, press and hold the CH/ENTER knob to permanently store the your User MMSI and return to the DSC Setup Submenu.

NOTE: To exit the DSC Setup Submenu or one of the further submenus under it, press the 16/9 or CANCEL/WX keys until you have left the submenus. You will also exit the DSC Setup Submenu automatically by turning the unit off. All changes are saved in EEPROM (except for manually-entered GPS data).

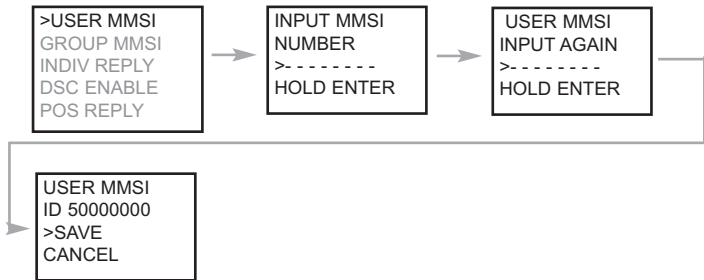

- You can view your stored User MMSI at any time by selecting user MMSI from the DSC SETUP menu.

DSC SETUP: CREATE AND MANAGE GROUP MMSIS

You can save up to three Group MMSI numbers and associated Group names. Group MMSI numbers always begin with a zero (0). You will only enter the last 8 digits of the Group MMSI, as the initial "0" is entered automatically.

To enter Group MMSIs:

1. From the DSC Setup Submenu, select GROUP MMSI. If existing Group Names and Group MMSIs are stored, they will be displayed. If there are no existing names, dashed lines will appear on the LCD instead.
2. To enter a Group Name and MMSI into a blank line, rotate the CH/ENTER knob to select the first desired character (A-Z, 1-9, space and back arrow "<") for the name. When the desired character is shown, press the CH/ENTER knob to select it; continue to select characters for the Group Name in this way. When the last digit is entered, you will be automatically advanced to the first MMSI digit.

NOTE: Some characters may be spaces; turn the CH/ENTER knob one click counterclockwise to remove a _ and replace it with a blank space, then press the CH/ENTER knob once more to select it and move to the next character.

3. Enter the MMSI number associated with that Group Name . The first digit is required to be a "0" (zero), and is entered automatically, so you only need to enter 8 digits to complete the 9 digit MMSI. A confirmation message will appear to ask you if you want to save the Group Name.
- 4a. Press the CH/ENTER knob to save the new entry.

or

- 4b. Press the CANCEL/WX key to terminate the process without saving; you will be taken back to the Group MMSI screen.

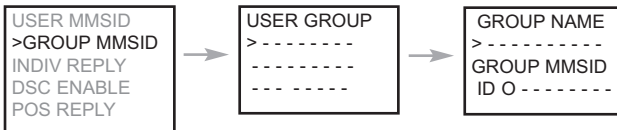

To edit an existing Group MMSI entry:

1. From the DSC Setup Submenu, select GROUP MMSI, then select an existing Group Name and press the CH/ENTER knob to see the EDIT and DELETE choices for the selected Group Name and associated MMSI. Select the Group Name or only the desired MMSI. Choose EDIT.
2. When you are finished editing, press the CH/ENTER knob. You will be prompted to save your changes.
3. Press the CH/ENTER knob again to save your edits. The Group MMSIs are displayed again. If more changes are required, repeat steps 1 through 3; otherwise, press the CANCEL/WX key to exit.



To delete a Group MMSI:

1. From the DSC Setup Submenu, select GROUP MMSI, then select an existing Group Name and press the CH/ENTER knob to see the EDIT and DELETE choices for the selected Group Name and associated MMSI. Choose DELETE.
2. The DELETE GROUP menu will be displayed for that particular group name. An arrow will point to YES; press the CH/ENTER knob to empty the group and return to the USER GROUP screen. The LCD displays the group for >_____.
3. If you need to delete more Group Names, repeat steps 1 through 2; otherwise, press the CANCEL/WX key to exit.



DSC SETUP: INDIVIDUAL REPLY

You can set up your radio to respond to incoming individual calls with either an automatic response or to wait for you to reply manually.

1. From the DSC Setup Submenu, select INDIV REPLY to display the INDIV REPLY MANUAL or AUTOMATIC choices.
2. Select AUTOMATIC for an automatic response, or MANUAL for a manual response using the CH/ENTER knob.

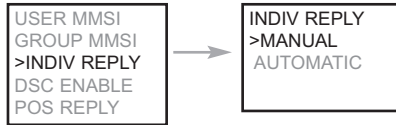

DSC SETUP: DSC ENABLE

Use this feature to turn off the DSC function temporarily, such as when you are sailing to inland water or entering a No DSC region where DSC cannot be used.

1. From the DSC Setup Submenu, select DSC ENABLE to display DSC ENABLE ON/OFF.
2. Select OFF to disable the DSC function using the CH/ENTER knob.

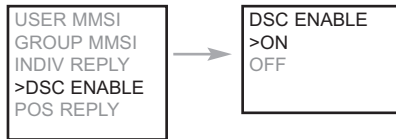

DSC SETUP: POSITION REPLY

You can set the radio to respond to a Position Request in one of three ways: Automatic, Manual, or Off (no response).

1. From the DSC Setup Submenu, select POS REPLY, then choose either AUTOMATIC, MANUAL, and OFF using the CH/ENTER knob.



DSC SETUP: RESET

This feature resets most settings to the factory defaults, except for the USER MMSI and the Contact List.

1. From the DSC Setup Submenu, select RESET; the radio will ask for confirmation.
2. Select YES, then press the CH/ENTER knob to reset the radio.

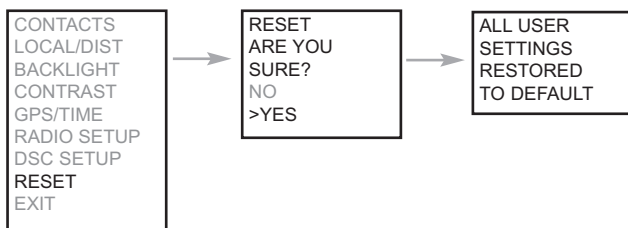

MAINTENANCE

To keep your Humminbird® VHF255S working properly, perform the following maintenance as needed.

If your unit comes into contact with salt spray, simply wipe the affected surfaces with a cloth dampened in fresh water. Do not use a chemical glass cleaner on the lens, as chemicals in the solution may cause cracking in the lens. When cleaning the LCD protective lens, use a chamois and non-abrasive, mild cleaner. Do not wipe while dirt or grease is on the lens. Be careful to avoid scratching the lens.

WARNING: *Never leave your VHF255S in a closed car or trunk; the extremely high temperatures generated in hot weather can damage the electronics.*

TROUBLESHOOTING

Before contacting the Humminbird® Customer Resource Center, please read the following section. Taking the time to review these troubleshooting guidelines may allow you to solve a performance problem yourself, and therefore avoid sending your unit back for repair.

NOTE: *Do not attempt to repair the VHF255S yourself, as there are no user serviceable parts inside, and special tools and techniques are required for reassembly in order to maintain the waterproof integrity of the housing. Repairs should be performed only by authorized Humminbird® technicians.*

VHF255S DOESN'T POWER UP

If your VHF255S doesn't power up, refer to the Installation section, and make sure that:

- The power connection to the radio base station is correct.
- The volume control is turned up high enough for you to hear.

Correct any problems discovered.

NO SOUND FROM THE SPEAKER

If your VHF255S speaker is not emitting sound, refer to the Installation section, and make sure that:

- The volume control is turned up high enough for you to hear.
- SQUELCH is set to the threshold point.
- The internal speaker is turned on (see *Radio Setup: Turning the Internal Speaker On/Off* for more information).

Correct any problems discovered.

TRANSMITTING IS IMPOSSIBLE, OR HIGH POWER CAN'T BE SELECTED

If your VHF255S cannot transmit, or you cannot select high power, refer to the Installation section, and make sure that:

- Sufficient power is being supplied to the radio (12 Volts @ 7 Amps).
- The PTT key is operating correctly.
- The microphone or MIC jack are operating correctly.
- Change to another channel, as some channels are for low power or are receive only.
- Press the HI/LOW/MEM key to select high power.

Correct any problems discovered.

LOW RECEIVER SENSITIVITY

If your VHF255S either has low receiver sensitivity (has difficulty receiving faint signals), refer to the Installation section, and make sure that:

- The antenna is connected correctly.
- The connection between the coaxial cable and the radio base station is correct and securely-fastened.

Correct any problems discovered.

3-YEAR LIMITED WARRANTY

We warrant the original retail purchaser that products made by Humminbird® have been manufactured free from defects in materials and workmanship. This warranty for the VHF255S radio is effective for three years from the date of original retail purchase. Humminbird® products found to be defective and covered by this warranty will be replaced or repaired free of charge at Humminbird's option and returned to the customer freight prepaid. Humminbird's sole responsibility under this warranty is limited to the repair or replacement of a product that has been deemed defective by Humminbird®. Humminbird® is not responsible for charges connected with the removal of such product or reinstallation of replaced or repaired parts.

This warranty does not apply to a product that has been:

- Improperly installed;
- Used in an installation other than that recommended in the product installation and operation instructions;
- Damaged or has failed because of an accident or abnormal operation;
- Repaired or modified by entities other than Humminbird®.

Please retain your original receipt as a proof of the purchase date. This will be required for in-warranty service.

THIS WARRANTY IS EXPRESSLY IN LIEU OF ANY OTHER WARRANTIES, OBLIGATIONS OR LIABILITIES ON THE PART OF HUMMINBIRD® AND WILL BE THE CUSTOMER'S EXCLUSIVE REMEDY, EXCEPT FOR ANY APPLICABLE IMPLIED WARRANTIES UNDER STATE LAW WHICH ARE HEREBY LIMITED IN DURATION TO THREE YEARS FROM THE DATE OF ORIGINAL PURCHASE. IN NO EVENT WILL HUMMINBIRD® BE LIABLE FOR ANY INCIDENTAL OR CONSEQUENTIAL DAMAGES FOR BREACH OF ANY EXPRESS OR IMPLIED WARRANTY RELATING TO THE PRODUCTS.

Some states do not allow limitations on an implied warranty, or the exclusion of incidental or consequential damages, so the above exclusions may not apply to you. You may also have other rights, which vary from state to state.

HUMMINBIRD® SERVICE POLICY

Even though you'll probably never need to take advantage of our incredible service policy, it's good to know that we back our products this confidently. We do it because you deserve the best. We will make every effort to repair your unit within three business days from the receipt of your unit at our factory. This does not include shipping time to and from our factory. Units received on Friday are typically shipped by the following Wednesday, units received Monday are typically shipped by Thursday, etc.

All repair work is performed by factory-trained technicians to meet exacting factory specifications. Factory-serviced units go through the same rigorous testing and quality control inspections as new production units.

After the original warranty period, a standard flat rate service charge will be assessed for each repair (physical damage and missing parts are not included). Any repairs made after the original warranty will be warranted for an additional 90 days after service has been performed by our factory technicians. You can contact our Customer Resource Center or visit our website to verify the flat rate repair fee for your product (visit the Product Support section):

<http://www.humminbird.com>

We reserve the right to deem any product unserviceable when replacement parts are no longer available or impossible to obtain. This Service Policy is valid in the United States only. This applies only to Humminbird® products returned to our factory in Eufaula, Alabama. This Service Policy is subject to change without notice.

RETURNING YOUR UNIT FOR SERVICE

Before sending your unit in for repair, please contact the factory, either by phone or by email, to obtain a Repair Authorization Number for your unit. Please have your product model name and serial number available before calling the factory. If you contact the factory by e-mail, please include your product model name and serial number in the e-mail, and use Request for Repair Authorization Number for your e-mail subject header. You should include your Repair Authorization Number in all subsequent communications about your unit.

For IN-WARRANTY service, complete the following steps:

- Obtain a Repair Authorization Number from the Humminbird® Customer Resource Center.
- Tag product with your name, street address, phone number and your assigned Repair Authorization Number.
- Include a brief written description of the problem.
- Include a copy of your receipt (to show proof and date of purchase).
- Return product freight prepaid to Humminbird®, using an insured carrier with delivery confirmation.

For OUT-OF-WARRANTY service, complete the following steps:

- Obtain a Repair Authorization Number from the Humminbird® Customer Resource Center.
- Include payment in the form of credit card number and expiration date, money order or personal check. Please do not send cash.
- Tag product with your name, street address, phone number and your assigned Repair Authorization Number.
- Include a brief written description of the problem.
- Return product freight prepaid to Humminbird®, using an insured carrier with delivery confirmation.

SPECIFICATIONS

Channels	All U.S., Canadian and International Channels
	All NOAA Weather Channels
Frequency Method	Phase Lock Loop
Frequency Range	TX 156.050 ~ 157.425 MHz
	RX 156.025 ~163.275 MHz
Antenna Impedance	50 Ohm
Microphone	Condensor Type
Power Supply	13.8 VDC (Nominal Voltage for a 12 Volt Marine Power System)
Display	Backlit Liquid Crystal Display (LCD)
Operating Temperatures	-4° F to 140° F (-20° C to 60° C)
Dimensions	2.80 in (71 mm) [H] x 6.30 in (161 mm) [W] x 5.80 in (147 mm) [D]
Weight	1.20 lbs (545 grams)
Waterproof Rating	Meets JIS Level 7 Standard

TRANSMITTER:

Power Output	1 or 25 Watts (Selectable)
Modulation Type	FM
S/N at 3 KHz Dev.	35 dB
Modulation Distortion	+/- 3 kHz, ≤ 7%
Spurious/Harmonic Emissions	High/Low, ≥ 70/60 dB
Modulation Sensitivity	≥ 12 μV

RECEIVER:

Sensitivity at 12 dB SINAD	≤ -6 (EMF) dBμV
Spurious Response Rejection Ratio	≥ 65 dB
Adjacent Channel Selectivity	≥ 65 dB
S/N at 3 kHz Dev.	≥ 40 dB
Audio Distortion	≤ 10%

NOTE: Product specifications and features are subject to change without notice.

FCCID:KLLTM-366

MARINE CHANNELS

Refer to the following Marine Channels tables, depending on your location.

NOAA* Weather Radio Frequencies		
<u>Channel</u>	<u>Frequency (MHz)</u>	<u>Use</u>
WX0	163.275	NOAA Weather.
WX1	162.550	NOAA Weather.
WX2	162.400	NOAA Weather.
WX3	162.475	NOAA Weather.
WX4	162.425	NOAA Weather.
WX5	162.450	NOAA Weather.
WX6	162.500	NOAA Weather.
WX7	162.525	NOAA Weather.
WX8	161.650	Canadian Weather.
WX9	161.775	Canadian Weather.

** NOAA stands for National Oceanic and Atmospheric Administration.*

U.S. Marine Channels

Channel No.	Ship Transmit MHz	Ship Receive MHz	Use
01A	156.050	156.050	Port Operations and Commercial, VTS*. Available Only in New Orleans / Lower Mississippi area.
05A	156.250	156.250	Port Operations or VTS in the Houston, New Orleans and Seattle areas.
06	156.300	156.300	Intership Safety.
07A	156.350	156.350	Commercial.
08	156.400	156.400	Commercial (Intership Only).
09	156.450	156.450	Boater Calling. Commercial and Non-Commercial.
10	156.500	156.500	Commercial.
11	156.550	156.550	Commercial. VTS in Selected Areas.
12	156.600	156.600	Port Operations. VTS in Selected Areas.
13	156.650	156.650	Intership Navigation Safety (Bridge to Bridge). Ships >20 m in Length Maintain a Listening Watch on this Channel in U.S. Waters.
14	156.700	156.700	Port Operations. VTS in Selected Areas.
15	--	156.750	Environmental (Receive Only). Used by Class C EPIRBs.
16	156.800	156.800	International Distress, Safety and Calling. Ships Required to Carry Radio, USCG, and Most Coast Stations Maintain a Listening Watch on this Channel.
17	156.850	156.850	State Control.
18A	156.900	156.900	Commercial.
19A	156.950	156.950	Commercial.
20	157.000	161.600	Port Operations (duplex).
20A	157.000	157.000	Port Operations.
21A	157.050	157.050	U.S. Coast Guard only.
22A	157.100	157.100	Coast Guard Liaison and Maritime Safety Information Broadcasts. Broadcasts Announced on Channel 16.
23A	157.150	157.150	U.S. Coast Guard Only.
24	157.200	161.800	Public Correspondence (Marine Operator).
25	157.250	161.850	Public Correspondence (Marine Operator).
26	157.300	161.900	Public Correspondence (Marine Operator).

U.S. Marine Channels

Channel No.	Ship Transmit MHz	Ship Receive MHz	Use
27	157.350	161.950	Public Correspondence (Marine Operator).
28	157.400	162.000	Public Correspondence (Marine Operator).
63A	156.175	156.175	Port Operations and Commercial, VTS. Available Only in New Orleans / Lower Mississippi area.
65A	156.275	156.275	Port Operations.
66A	156.325	156.325	Port Operations.
67	156.375	156.375	Commercial. Used for Bridge to Bridge Communications in Lower Mississippi River. Intership Only.
68	156.425	156.425	Non-Commercial.
69	156.475	156.475	Non-Commercial.
70	156.525	156.525	Digital Selective Calling (Voice Communications Not Allowed).
71	156.575	156.575	Non-Commercial.
72	156.625	156.625	Non-Commercial (Intership Only).
73	156.675	156.675	Port Operations.
74	156.725	156.725	Port Operations.
77	156.875	156.875	Port Operations (Intership Only).
78A	156.925	156.925	Non-Commercial.
79A	156.975	156.975	Commercial. Non-Commercial in Great Lakes Only.
80A	157.025	157.025	Commercial. Non-Commercial in Great Lakes Only.
81A	157.075	157.075	U.S. Government Only - Environmental Protection Operations.
82A	157.125	157.125	U.S. Government Only.
83A	157.175	157.175	U.S. Coast Guard Only.
84	157.225	161.825	Public Correspondence (Marine Operator).
85	157.275	161.875	Public Correspondence (Marine Operator).
86	157.325	161.925	Public Correspondence (Marine Operator).
88A	157.425	157.425	Commercial, Intership Only.

** VTS stands for Vessel Traffic Service, and is a system that provides active monitoring and navigational advice for vessels in particularly confined and busy waterways.*

International Marine Channels

Channel No.	Ship Transmit MHz	Ship Receive MHz	Use
01	156.050	160.650	Public Correspondence (Marine Operator).
02	156.100	160.700	Public Correspondence (Marine Operator).
03	156.150	160.750	Public Correspondence (Marine Operator).
04	156.200	160.800	Public Correspondence (Marine Operator).
05	156.250	160.850	Public Correspondence (Marine Operator), Port Operations, Ship Movement.
06	156.300	156.300	Intership Safety.
07	156.350	160.950	Public Correspondence (Marine Operator), Port Operations, Ship Movement.
08	156.400	156.400	Intership.
09	156.450	156.450	Intership, Port Operations, Ship Movement.
10	156.500	156.500	Intership.
11	156.550	156.550	Port Operations, Ship Movement.
12	156.600	156.600	Port Operations, Ship Movement.
13	156.650	156.650	Intership Navigation, Safety.
14	156.700	156.700	Port Operations, Ship Movement.
15 (1)	156.750	156.750	On Board Communications, Intership.
16	156.800	156.800	International Distress, Safety.
17 (1)	156.850	156.850	On Board Communications, Intership.
18	156.900	161.500	Public Correspondence (Marine Operator), Port Operations, Ship Movement.
19	156.950	161.550	Public Correspondence (Marine Operator), Port Operations, Ship Movement.
20	157.000	161.600	Public Correspondence (Marine Operator), Port Operations, Ship Movement.
21	157.050	161.650	Public Correspondence (Marine Operator), Port Operations, Ship Movement.
22	157.100	161.700	Public Correspondence (Marine Operator), Port Operations, Ship Movement.
23	157.150	161.750	Public Correspondence (Marine Operator).
24	157.200	161.800	Public Correspondence (Marine Operator).
25	157.250	161.850	Public Correspondence (Marine Operator).
26	157.300	161.900	Public Correspondence (Marine Operator).
27	157.350	161.950	Public Correspondence (Marine Operator).
28	157.400	162.000	Public Correspondence (Marine Operator).
60	156.025	160.625	Public Correspondence (Marine Operator), Port Operations, Ship Movement.
61	156.075	160.675	Public Correspondence (Marine Operator), Port Operations, Ship Movement.

International Marine Channels

Channel No.	Ship Transmit MHz	Ship Receive MHz	Use
62	156.125	160.725	Public Correspondence (Marine Operator). Port Operations, Ship Movement.
63	156.175	160.775	Public Correspondence (Marine Operator). Port Operations, Ship Movement.
64	156.225	160.825	Public Correspondence (Marine Operator). Port Operations, Ship Movement.
65	156.275	160.875	Public Correspondence (Marine Operator). Port Operations, Ship Movement.
66	156.325	160.925	Public Correspondence (Marine Operator). Port Operations, Ship Movement.
67	156.375	156.375	Intership, Port Operations.
68	156.425	156.425	Port Operations, Ship Movement.
69	156.475	156.475	Intership, Port Operations, Ship Movement.
71	156.575	156.575	Port Operations, Ship Movement.
72	156.625	156.625	Intership, Port Operations, Ship Movement.
73	156.675	156.675	Intership, Port Operations, Ship Movement.
74	156.725	156.725	Port Operations, Ship Movement.
77	156.875	156.875	Intership.
78	156.925	161.525	Public Correspondence, Port Operations.
79	156.975	161.575	Public Correspondence, Port Operations.
80	157.025	161.625	Public Correspondence, Port Operations.
81	157.075	161.675	Public Correspondence, Port Operations.
82	157.125	161.725	Public Correspondence, Port Operations.
83	157.175	161.775	Public Correspondence, Port Operations.
84	157.225	161.825	Public Correspondence, Port Operations.
85	157.275	161.875	Public Correspondence, Port Operations.
86	157.325	161.925	Public Correspondence, Port Operations.
87A	157.375	157.375	Public Correspondence, Port Operations.
88A	157.425	157.425	Public Correspondence, Port Operations.

1. For channels 15 and 17, output power is fixed at 1 Watt only. Transmission at high power is not permitted.

2. Channel 70 is used for Digital Selective Calling (DSC) only and is not available for voice transmissions. Channel 70 does not appear on the display.

IMPORTANT NOTICE: The International frequency mode is not legal for use while operating in U.S. waters. The TX/RX frequencies available in International frequency mode were agreed upon by the attending countries at the 1968 ITU-International Telecommunication Union meeting in Geneva, and are legal for use in International waters only.

Canadian Marine Channels

Channel No.	Ship Transmit MHz	Ship Receive MHz	Use
01	156.050	160.650	Public Correspondence (Marine Operator)
02	156.100	160.700	Public Correspondence (Marine Operator)
03	156.150	160.750	Public Correspondence (Marine Operator)
04A	156.200	156.200	Pacific Coast: Coast Guard, East Coast: Commercial Fishing
05A	156.250	156.250	Port Operation, VTS in Seattle.
06	156.300	156.300	Intership Safety
07A	156.350	156.350	Commercial
08	156.400	156.400	Commercial Intership only.
09	156.450	156.450	Boater Calling Channel, Commercial and Noncommercial (Recreational).
10	156.500	156.500	Commercial.
11	156.550	156.550	Commercial. VTS in Selected Areas.
12	156.600	156.600	Port Operations. VTS in Selected Areas.
13	156.650	156.650	Intership Navigation Safety (Bridge to Bridge)
14	156.700	156.700	Port Operations. VTS in Selected Areas.
15	156.750	156.750	Commercial, Noncommercial, Ship Movement (1 Watt only)
16	156.800	156.800	International Distress, Safety and Calling
17	156.850	156.850	State Controlled (1 Watt only).
18A	156.900	161.500	Commercial
19A	156.950	156.950	Coast Guard
20	157.000	161.600	Coast Guard
21A	157.050	157.050	Coast Guard
22A	157.100	157.100	U.S. And Canadian Coast Guard Liaison And Maritime Safety Info. Broadcasts Announced On Ch. 16
23	157.150	161.750	Public Correspondence (Marine Operator)
24	157.200	161.800	Public Correspondence (Marine Operator)
25	157.250	161.850	Public Correspondence (Marine Operator)
26	157.300	161.900	Public Correspondence (Marine Operator)
27	157.350	161.950	Public Correspondence (Marine Operator)
28	157.400	162.000	Public Correspondence (Marine Operator)

Canadian Marine Channels

Channel No.	Ship Transmit MHz	Ship Receive MHz	Use
60	156.025	160.625	Public Correspondence (Marine Operator)
61A	156.075	156.075	Pacific Coast: Coast Guard East Coast: Commercial Fishing Only.
62A	156.125	156.125	Pacific Coast: Coast Guard East Coast: Commercial Fishing Only.
63A	156.175	156.175	Port Operation and Commercial. VTS in Selected Areas.
64A	156.225	156.225	Commercial Fishing
65A	156.275	156.275	Port Operations
66A	156.325	156.325	Port Operations
67	156.375	156.375	Commercial Fishing
68	156.425	156.425	Noncommercial (Recreational)
69	156.475	156.475	Commercial Fishing Only
71	156.575	156.575	Noncommercial (Recreational)
72	156.625	156.625	Noncommercial (Intership Only)
79A	156.975	156.975	Commercial
80A	157.025	157.025	Commercial
81A	157.075	157.075	U.S. Government Only, Environmental Protection Operations
82A	157.125	157.125	Coast Guard Only
84	157.225	161.825	Public Correspondence (Marine Operator)
85	157.275	161.875	Public Correspondence (Marine Operator)
86	157.325	161.925	Public Correspondence (Marine Operator)
87	157.375	161.975	Public Correspondence (Marine Operator)
88	157.425	162.025	Public Correspondence (Ship to Coast)

** VTS stands for Vessel Traffic Service, and is a system that provides active monitoring and navigational advice for vessels in particularly confined and busy waterways.
VHF CHANNELS.*

MENU TREE

The following schematic shows the relationship between the various menu choices that may be displayed on the LCD.

DSC CALL TYPE LIST

These menu choices appear when you press the DSC/MENU key.

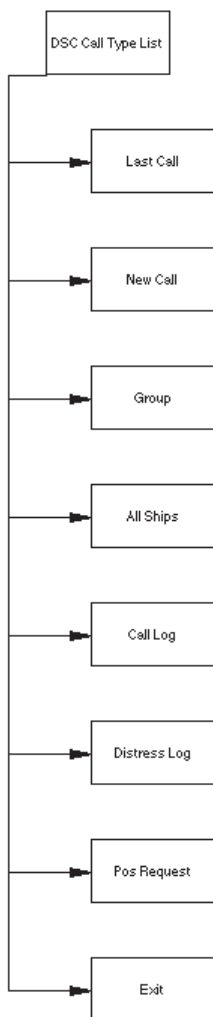

SETUP MENU

These menu choices appear when you **press and hold** the DSC/MENU key.

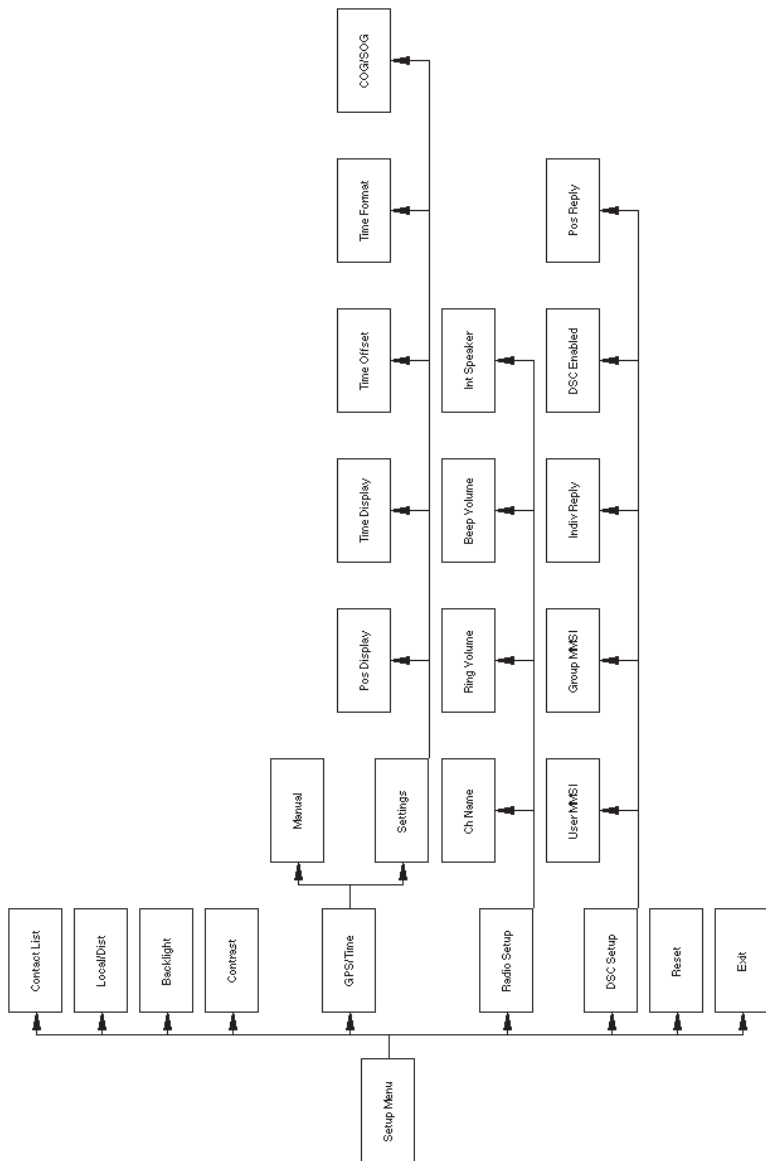

NOTES

NOTES

NOTES

Contact Humminbird®

Contact the Humminbird® Customer Resource Center
in any of the following ways:

By Telephone:

(Monday - Friday 8:00 a.m. to 4:30 p.m. Central Standard Time):

1-800-633-1468

By e-mail:

(typically we respond to your e-mail within three business days):

custserv@johnsonoutdoors.com

For direct shipping, our address is:

Humminbird

Service Department

678 Humminbird Lane

Eufaula, AL 36027 USA

