

FURUNO

OPERATOR'S MANUAL

MARINE VHF RADIOTELEPHONE

MODEL FM-3000



FURUNO ELECTRIC CO., LTD.
NISHINOMIYA, JAPAN

FOREWORD

Congratulations on your choice of the FURUNO FM-3000 Marine VHF Radiotelephone. We are confident that you will enjoy many years of trouble-free operation with this fine piece of equipment.

For more than 50 years FURUNO Electric Company has enjoyed an enviable reputation for quality and reliability throughout the world. This dedication is furthered by our extensive global network of agents and dealers.

Your equipment is designed and constructed to provide commercial grade performance and reliability, yet is affordable for pleasure craft owners.

Please carefully read this manual and follow the recommended procedure for installation, operation and maintenance. With proper care, your equipment should provide years of enjoyable and dependable communications.

Thank you for considering and purchasing FURUNO.

IMPORTANT

READ ALL INSTRUCTIONS carefully and completely before using the transceiver.

◇ **FEATURES**

- *Standard 4"×6" flush mount design*
- *Built-in DSC meets RTCM SC101 requirement*
- *Rugged waterproof construction*
- *NMEA Input/Output*
- *Optional CONTROLLABLE MIC is connectable*

SAVE THIS ~~INSTRUCTION~~ MANUAL — This ~~in-~~
~~struction~~ manual contains important operating instructions for the FM-3000.

IN CASE OF EMERGENCY

If your vessel requires assistance, contact other vessels and the Coast Guard by sending a distress call on Ch 16.

USING CHANNEL 16

DISTRESS CALL PROCEDURE

1. "MAYDAY MAYDAY MAYDAY."
2. "THIS IS" (name of vessel)
3. Your call sign or other indication of the vessel (AND 9-digit DSC ID if you have one).
4. "LOCATED AT" (your position)
5. The nature of the distress and assistance required.
6. Any other information which might facilitate the rescue.

Or, transmit your distress call using digital selective calling on Ch 70.

USING DIGITAL SELECTIVE CALLING (Ch 70)

DISTRESS CALL PROCEDURE

1. While lifting up the switch cover, push and hold **[DISTRESS]** for 5 sec. until you hear 5 short beeps change to one long beep.
2. Wait for an acknowledgment from a coast station.
 - Channel 16 is automatically selected.
3. Push and hold **[PTT]**, then transmit the appropriate information as at above.

NOTE

A WARNING STICKER is supplied with the transceiver.

To comply with FCC regulations, this sticker must be affixed in such a location as to be readily seen from the operating controls of the radio as in the diagram below. Make sure the chosen location is clean and dry before applying the sticker. (p. viii)

EXAMPLE



CLEAN THE TRANSCEIVER AND MICROPHONE THOROUGHLY WITH FRESH WATER after exposure to water including salt water, otherwise, the keys and switches may become inoperable due to salt crystallization.



SAFTY INSTRUCTION

For the operator

CAUTION

Do not open the equipment.

Only qualified personal should work inside the equipment.

Do not disassemble or modify the equipment.

Fire, electrical shock or serious injury can result.

Turn off the power immediately if waterleaks into the equipment or the equipment is emitting smoke or fire.

Continued use of the equipment can cause fire or electrical shock.

Any repair work must be done by a licensed radio technician.

Improper repair work can cause electrical shock or fire.

CAUTION

BE CAREFUL! The transceiver and optional FM-3010 employ waterproof construction, which corresponds to JIS waterproof specification, Grade 7 (1 m/30 min.). However, once the transceiver or microphone has been dropped, waterproofing cannot be guaranteed due to the fact that the case may be cracked, or the waterproof seal damaged, etc.

AVOID the use of chemical agents such as benzine or alcohol when cleaning, as they may damage the transceiver surfaces.

Distances at which radiation levels of 100 and 10 W/m² exist are given in the table.

Distance to 100 W/m ² point	Distance to 10 W/m ² point
0.12 m	0.39 m

For the installer

WARNING



ELECTRICAL SHOCK HAZARD
Do not open the equipment unless totally familiar with electrical circuits and service manual.

Only qualified personal should work inside the equipment.

Be sure that the power supply is compatible with the voltage rating of the equipment.

Connection of an incorrect power supply can cause fire or equipment damage. The voltage rating of the equipment appears on the label above the power connector.

Turn off the power at the switchboard before beginning the installation.

Fire or electrical shock can result if the power is left on.

DO NOT install the equipment where normal operation of the vessel may be hindered or where it could cause bodily injury.

WARNING

DO NOT cut the DC power cable between the DC plug and fuse holder. If an incorrect connection is made after cutting, the equipment may be damaged.

CAUTION



Ground the equipment to prevent electrical shock and mutual interference.

Observe the following compass safe distances to prevent interference to a magnetic compass:

	Standard compass	Steering compass
Transceiver	0.95 m	0.65 m

Table of Contents

FOREWORD	i	5 DSC Operation	13
IMPORTANT	i	5.1 MMSI Code Programming	13
IN CASE OF EMERGENCY	ii	5.2 DSC Individual ID	13
NOTE	ii	5.3 Position and Time Programming	15
SAFTY INSTRUCTION	iii	5.4 Position/Time Indication	16
Table of Contents	v	5.5 Distress Call	17
System Configuration	vii	5.6 Transmitting DSC Calls	20
Standard supply & Options	viii	5.7 Receiving DSC Calls	28
1 Control	1	5.8 Received Messages	31
1.1 Front Panel	1	5.9 DSC Set Mode	33
1.2 Function Display	3	6 Other Functions	35
1.3 Microphone	4	6.1 Intercom Operation	35
2 Basic Operation	5	6.2 Microphone Lock Function	36
2.1 Channel Selection	5	6.3 Display Backlighting	36
2.2 Receiving and Transmitting	7	7 SET MODE	37
2.3 Call Channel Programming	8	7.1 Set Mode Programming	37
Channel Comments	8	7.2 Set Mode Items	38
Optional Voice Scrambler Operation	9	8 CONNECTIONS AND MAINTENANCE	41
3 Dualwatch/TRI-watch	10	8.1 Antenna	41
Description	10	8.2 Fuse Replacement	41
Operation	10	8.3 Cleaning	41
4 Scan Operation	11	8.4 Connections	42
Scan Types	11	8.5 Mounting the Transceiver	43
Setting Tag Channels	12	8.6 Optional Unit Installation	45
Starting a Scan	12	8.7 Dimensions	46

9 TROUBLESHOOTING	47
10 CHANNEL LIST	48
11 OPERATING RULES	49
12 SPECIFICATIONS	50
13 FM-3010 CONTROLLABLE MIC	51
13.1 Panel Description	51
13.2 Function Display	53
13.3 Channel Selection	55
13.4 Receiving and Transmitting	56
13.5 Lock Functions	57
13.6 Display Backlighting	57
13.7 Monitor Function	58
13.8 RF Attenuator Function	58
13.9 Call Channel Programming	58
13.10 Optional Voice Scrambler Operation	59
13.11 Dualwatch/Tri-watch Operation	59
13.12 Starting a Scan	60
13.13 Setting Tag Channels	60
13.14 Set Mode Programming	61
13.15 Intercom Operation	62
13.16 Channel Comments	62
13.17 FM-3010 Supplied Accessories	63
13.18 Installation	64

TEMPLATE

System Configuration

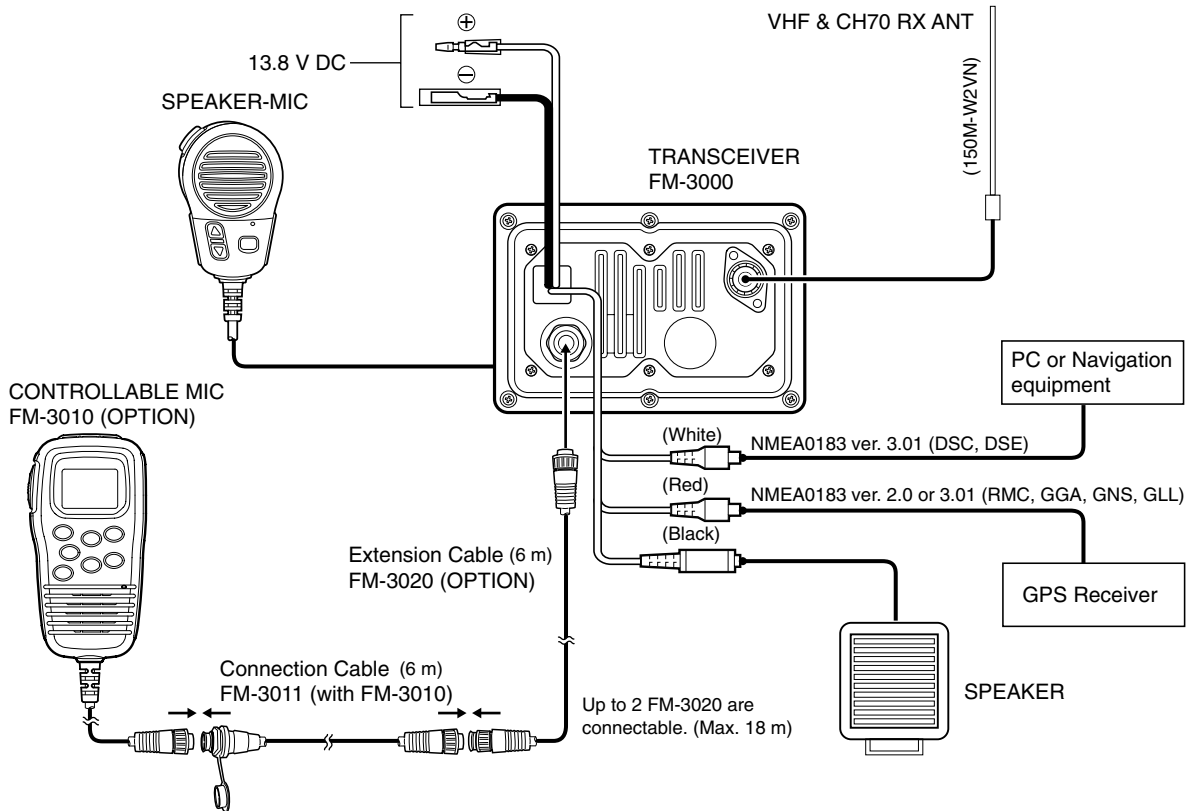

Standard supply & Options

Standard supply

The following accessories are supplied:	Qty.
① Mounting bracket	1
② Microphone hanger	1
③ Fuse (10 A)	2
④ Mic hanger screws (3 × 16)	2
⑤ Mounting screws (5 × 20)	4
⑥ Flat washers (M5)	4
⑦ Spring washers (M5)	4
⑧ Knob bolts for mounting bracket.....	2
⑨ DC power cable (FM-3003)	1
⑩ Warning sticker	1
⑪ RCA connector cable Red	1
⑫ RCA connector cable White	1

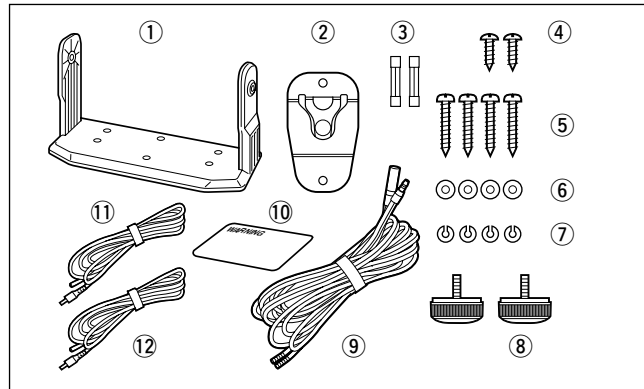

Options

- **FM-3010 CONTROLLABLE MIC** (p. 51)
External microphone-type controller. Provides optional Inter-com operation. 6 m (20 feet) microphone cable and mounting base included.
- **FM-3020 MICROPHONE EXTENSION CABLE**
6 m (20 feet) microphone extension cable for optional FM-3010. Up to 2 FM-3020 can be connected. (18 m; 60 feet maximum)
- **FM-3030 VOICE SCRAMBLER UNIT** (pgs. 9, 40)
Ensures private communications. 32 codes are available. Not available in some countries.
- **FM-3040 FLUSH MOUNT**
For mounting the transceiver to a panel.

1. Controls

1.1 Front Panel

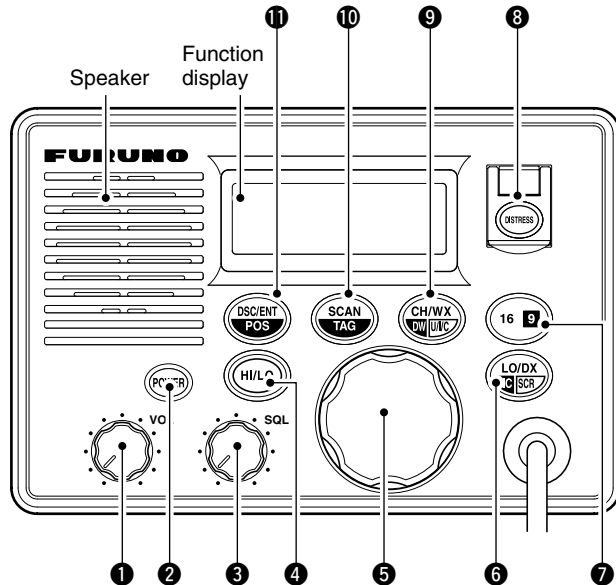

- ❶ **[VOL] control** (p. 7)
Adjusts the audio level.
- ❷ **[POWER] key**
Toggles the transceiver power ON or OFF.
- ❸ **[SQL] control** (p. 7)
Sets the squelch threshold level.
- ❹ **[HI/LO] key**
 - Toggles power high or low when pushed. (p. 7)
 - Some channels are set to low power only.
 - While pushing this key, some keys perform secondary functions.
- ❺ **[CHANNEL] knob**
 - Rotate **[CHANNEL]** to select the operating channels, Set mode settings, etc. (pgs. 7, 37)
 - While pushing **[HI/LO]**, rotate **[CHANNEL]** to adjust the brightness of the LCD and key backlight. (p.36)

1.Controls

6 [LO/DX] (**IC** **SCR**) key

- ➔ Toggles the Attenuator function ON or OFF when pushed momentarily. (p. 7)
 - "LOCAL" appears when the Attenuator is in use. The order of indication precedence is "SP OFF," "LOCAL" and "CALL."
- ➔ Activates an optional Intercom function when pushed for 1 sec. (p. 35)
- ➔ Calls optional FM-3010 when pushed and held while in Intercom mode. (p. 35)
- ➔ While pushing **[HI/LO]**, activates an optional Voice scrambler function. (p. 9)
 - The optional Voice scrambler function cannot be used on Channel 16 and 70.

7 [16] (**9**) key

- ➔ Selects Channel 16 when pushed. (p. 5)
- ➔ Selects call channel when pushed for 1 sec. (p. 5)
 - "CALL" appears when call channel is selected. "SP OFF" and "LOCAL" indications have priority.
- ➔ Push for 3 sec. to enter call channel programming condition when call channel is selected. (p. 8)
- ➔ While pushing **[HI/LO]**, enters channel comments programming condition. (p. 8)
- ➔ Enters Set mode when pushed while turning power ON. (p. 37)

8 [DISTRESS] key

Transmits Distress call when pushed for 5 sec. (p. 17)

9 [CH/WX] (**DW** **U/C**) key

- ➔ Selects and toggles the regular channels and weather channel when pushed momentarily. (p. 6)
- ➔ While pushing **[HI/LO]**, selects one of 3 regular channels in sequence when pushed. (p. 6)
 - International, U.S.A. and Canadian channels are available for regular channels.
- ➔ Starts Dualwatch or Tri-watch when pushed for 1 sec. (p. 10)
- ➔ Stops Dualwatch or Tri-watch when either is activated.

10 [SCAN] (**TAG**) key (p. 12)

- ➔ Starts and stops Normal or Priority scan when tag (scanned) channels are programmed.
- ➔ Push **[SCAN] (TAG)** for 1 sec. to set or cancel the displayed channel as a tag (scanned) channel.
- ➔ While pushing **[HI/LO]**, push for 3 sec. to clear or set all tag channels.

11 [DSC/ENT] (**POS**) key

- ➔ Selects the DSC menu when pushed. (p. 13)
- ➔ Shows current position and time from a GPS receiver, etc. when pushed for 1 sec. (p. 16)

1.Controls

1.2 Function Display

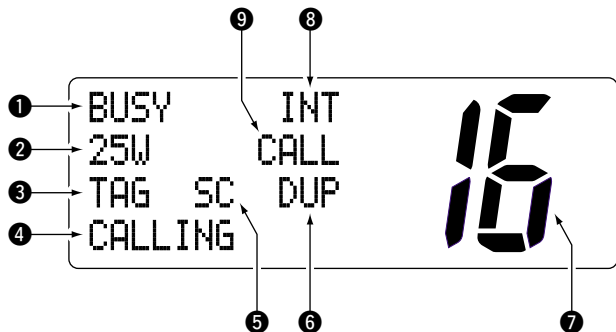

- ❶ **BUSY/TRANSMIT INDICATOR** (p. 7)
 - “BUSY” appears when receiving a signal or when the squelch opens.
 - “TX” appears while transmitting.
- ❷ **POWER INDICATOR** (p. 7)
 - “25W” appears when high power is selected.
 - “1W” appears when low power is selected.
- ❸ **TAG CHANNEL INDICATOR** (p. 12)

Appears when a tag channel is selected.
- ❹ **CHANNEL COMMENT INDICATOR**
 - Channel comment appears if programmed. (p. 8)
 - “Low Battery” blinks when the battery voltage drops to approx. 10 V DC or below.
 - “DUAL” appears during Dualwatch; “TRI” appears during Tri-watch. (p. 10)
- ❺ **SCRAMBLER INDICATOR** (p. 9)

Appears when an optional Voice scrambler is activated.

1.3 Microphone

6 DUPLEX INDICATOR (p. 6)

Appears when a duplex channel is selected.

- Duplex channel has a different TX and RX frequency.

7 CHANNEL NUMBER READOUT

- ➔ Indicates the selected operating channel number. “A” appears when a simplex channel is selected. “b” appears when a receive only channel for a Canadian channel group is selected. (p. 6)

- ➔ In Set mode, indicates the selected condition. (p. 37)

8 CHANNEL GROUP INDICATOR (p. 6)

Indicates whether an International “INT,” U.S.A. “USA,” Canadian “CAN” or weather “WEATHER” channel is selected.

9 CALL CHANNEL INDICATOR

- ➔ “CALL” appears when call channel is selected. (p. 5)
- ➔ “SP OFF” appears when the internal speaker is turned OFF in Set mode. (p. 39)
- ➔ “LOCAL” appears when the Attenuator is in use. (p. 7)
 - The order of indication precedence is “SP OFF,” “LOCAL” and “CALL.”

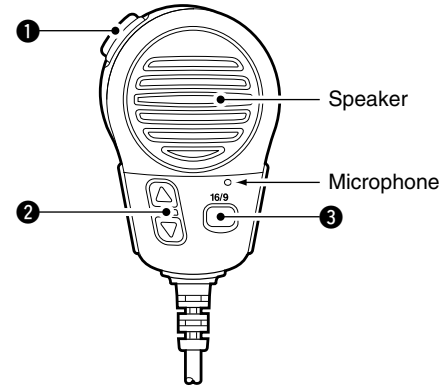

1 [PTT] switch (p. 7)

Push and hold to transmit; release to receive.

2 CHANNEL UP/DOWN KEYS [▲]/[▼] (pgs. 7, 37)

Push either key to change the operating channel, Set mode settings, etc.

3 [16/9] key

- ➔ Push to select Channel 16; push for 1 sec. to select call channel (default is Channel 9). (p. 5)
- ➔ While pushing [16/9], turn power ON to toggle the Lock function ON or OFF. (p. 36)

2. Basic Operation

2.1 Channel Selection

2.1.1 Channel 16

Channel 16 is the distress and safety channel. It is used for establishing initial contact with another station and for emergency communications. Channel 16 is monitored during both Dualwatch and Tri-watch. While standing by, you must monitor Channel 16.

- ➔ Push **[16]**  momentarily to select Channel 16.
- ➔ Push **[CH/WX]** to return to the condition before selecting Channel 16, or rotate **[CHANNEL]** to select operating channel.

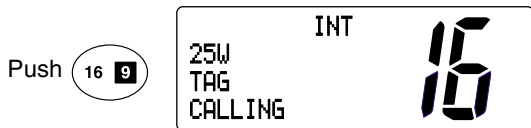

2.1.2 Channel 9 (Call channel)

Each regular channel group has a separate leisure-use call channel. Call channel is monitored during Tri-watch. Call channels can be programmed (p. 8) and are used to store your most often used channels in each channel group for quick recall.

- ➔ Push **[16]**  for 1 sec. to select call channel of the selected channel group.
 - “CALL” and call channel number appear.
 - Each channel group may have an independent call channel after programming a call channel.
- ➔ Push **[CH/WX]** to return to the condition before selecting call channel, or rotate **[CHANNEL]** to select an operating channel.

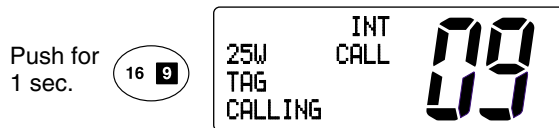

Convenient: Using microphone

- ➔ Push **[16/9]** momentarily to select Channel 16.
 - ➔ Push **[16/9]** for 1 sec. to select call channel.
 - ➔ Push **[▲]/[▼]** to select any other operating channel.
-

2. Basic Operation

2.1.3 U.S.A., Canadian and International channels

There are 57 U.S.A., 61 Canadian and 57 International channels. These channel groups may be specified for the operating area.

- ① Push **[CH/WX]** (**DW** **U/W/C**) to select a regular channel.
 - If a weather channel appears, push **[CH/WX]** (**DW** **U/W/C**) again.
- ② While pushing **[HI/LO]**, push **[CH/WX]** (**DW** **U/W/C**) to change the channel group, if necessary.
 - U.S.A., International (INT) and Canadian channels can be selected in sequence.
- ③ Rotate **[CHANNEL]** to select a channel.
 - “DUP” appears for duplex channels.
 - “A” appears for simplex channels.

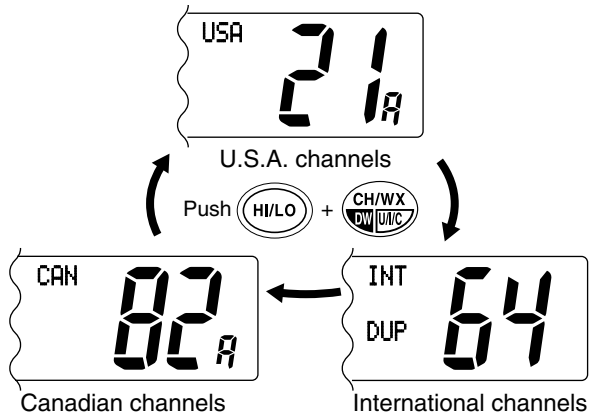

2.1.4 Weather channels

There are 10 weather channels. Used for monitoring weather channels from the NOAA (National Oceanographic and Atmospheric Administration) broadcasts.

The transceiver can detect a Weather alert tone on the selected weather channel while receiving that channel, during standby on a regular channel or while scanning. See “Weather alert” on p. 38.

- ① Push **[CH/WX]** once or twice to select a weather channel.
 - “WEATHER” appears when a weather channel is selected.
 - “WX ALT” appears when the Weather alert function is in use. (p. 38)

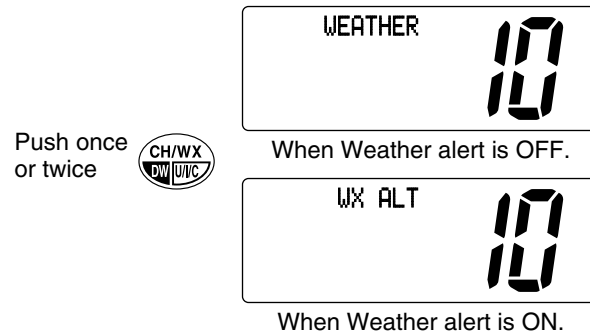

- ② Rotate **[CHANNEL]** to select a channel.

2. Basic Operation

2.2 Receiving and Transmitting

⚠ CAUTION

Transmitting without an antenna may damage the transceiver.

- ① Push **[POWER]** to turn power ON.
- ② Set the audio and squelch levels.
 - Rotate **[SQL]** fully counterclockwise in advance.
 - Rotate **[VOL]** to adjust the audio output level.
 - Rotate **[SQL]** clockwise until the noise disappears.
- ③ To change the channel group, push **[CH/WX]** (**[DW]** **[U/C]**) while pushing **[HI/LO]**. (p. 6)
- ④ Rotate **[CHANNEL]** or push **[▲]/[▼]** on the microphone to select the desired channel.
 - When receiving a signal, “**BUSY**” appears and audio is emitted from the speaker.
 - Further adjustment of **[VOL]** may be necessary.
 - Use the optional Voice scrambler function for privacy. (p. 9)
- ⑤ Push **[LO/DX]** to turn the receive Attenuator function ON or OFF, if necessary.
 - “**LOCAL**” appears when the receive Attenuator is in use.
- ⑥ Push **[HI/LO]** to select the output power, if necessary.
 - “**25W**” or “**1W**” appears when high or low power is selected, respectively.
 - Choose low power for short range communications, choose high power for longer distance communications.
 - Some channels are for selecting low power only.

- ⑦ Push and hold **[PTT]** to transmit, then speak into * (Microphone).
 - “**TX**” appears.
 - Channel 70 cannot be used for transmission other than DSC.

Note: Simplex channels, 3, 21, 23, 61, 64, 81, 82 and 83 **CANNOT** be lawfully used by the general public in U.S.A. waters.

- ⑧ Release **[PTT]** to receive.

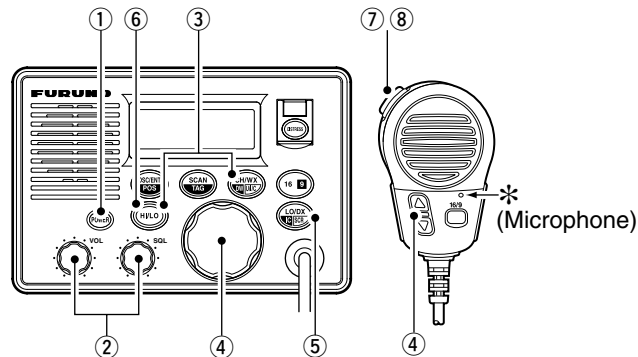

Important: To maximize the readability of your transmitted signal, pause a few sec. after pushing **[PTT]**, hold the microphone 2 to 4 inches (5 to 10 cm) from your mouth and speak into * (Microphone) at a normal voice level.

2.3 Call Channel Programming

Call channel is used to select Channel 9 (default), however, you can program the call channel with your most often-used channels in each channel group for quick recall.

- ① While pushing **[HI/LO]**, push **[CH/WX]** (**DW** **U/C**) one or more times to select the desired channel group (U.S.A., International, Canada) to be programmed.
- ② Push **[16]** (**9**) for 1 sec. to select call channel of the selected channel group.
 - “CALL” and call channel number appear.
 - The order of indication precedence is “SP OFF,” “LOCAL” and “CALL.”
- ③ Push **[16]** (**9**) again for 3 sec. (until a long beep changes to 2 short beeps) to enter call channel programming condition.
 - Channel number starts blinking.
- ④ Rotate **[CHANNEL]** to select the desired channel.
- ⑤ Push **[16]** (**9**) to program the displayed channel as call channel.
 - Push **[CH/WX]** (**DW** **U/C**) to cancel.
 - The channel number stops blinking.

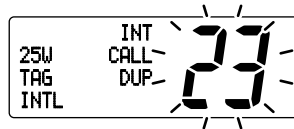
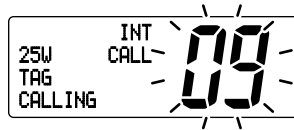

2.4 Channel Comments

Memory channels can be tagged with alphanumeric comments of up to 10 characters each.

Capital letters, small letters, numerals, some symbols (! " # \$ % & ' () * + , - . / : ;) and space can be used.

- ① Select the desired channel.
 - Cancel dualwatch, Tri-watch or scan in advance.
- ② While pushing **[HI/LO]**, push **[16]** (**9**) to edit the channel comment.
 - A cursor appears and blinks.

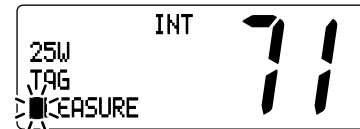

- ③ Select the desired character by rotating **[CHANNEL]** or by pushing **[▲]**/**[▼]** on the microphone.
 - Push **[CH/WX]** or **[SCAN]** to move the cursor forward or backward, respectively.
- ④ Push **[16]** (**9**) to input and set the comment.
 - Push **[HI/LO]** to cancel.
 - The cursor disappears.
- ⑤ Repeat steps ① to ④ to program the other channels, if desired.

2. Basic Operation

2.5 Optional Voice Scrambler Operation

2.5.1 Activating the Scrambler

The optional Voice scrambler provides private communications. In order to receive or send scrambled transmissions you must first activate the Scrambler function. To activate the function, an optional FM-3030 is necessary. See p. 40 for setting the scrambler unit. Ask your dealer for details.

Note: The Scrambler function automatically turns OFF when Channel 16 or 70 is selected.

- ① Select an operating channel other than Channel 16 or 70.
- ② While pushing **[HI/LO]**, push **[LO/DX]** (**[IC]** **[SCR]**) to turn the optional Scrambler function ON.
 - “SC” appears.
- ③ To turn the Scrambler function OFF, repeat step ②.
 - “SC” disappears.

2.5.2 Programming scrambler codes

There are 32 codes (1 to 32) available for programming when the optional FM-3030 is installed. In order to understand one another, all transceivers in your group must have the same scramble code. This function may not be available depending on dealer setting.

- ① Turn power OFF.
- ② While pushing **[16]** (**[9]**), turn power ON to enter Set mode.
- ③ After the display appears, release **[16]** (**[9]**).
- ④ Push **[16]** (**[9]**) one or more times to select the scrambler code.
 - “Scrambler Code” appears.
- ⑤ Rotate **[CHANNEL]** to select the desired scrambler code.
- ⑥ Turn power OFF, then ON again to exit Set mode.

[Example]: Programming scrambler code 8.

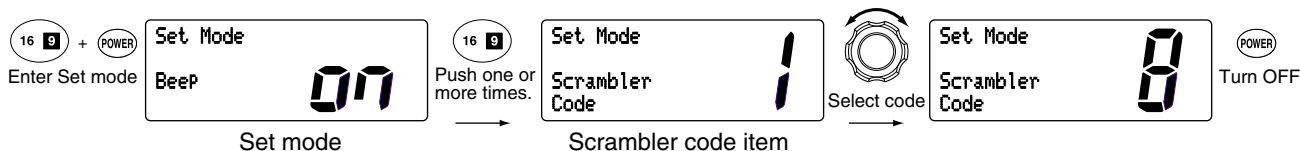

3. Dualwatch/Tri-Watch

3.1 Description

Dualwatch monitors Channel 16 while you are receiving another channel; Tri-watch monitors Channel 16 and call channel while receiving another channel.

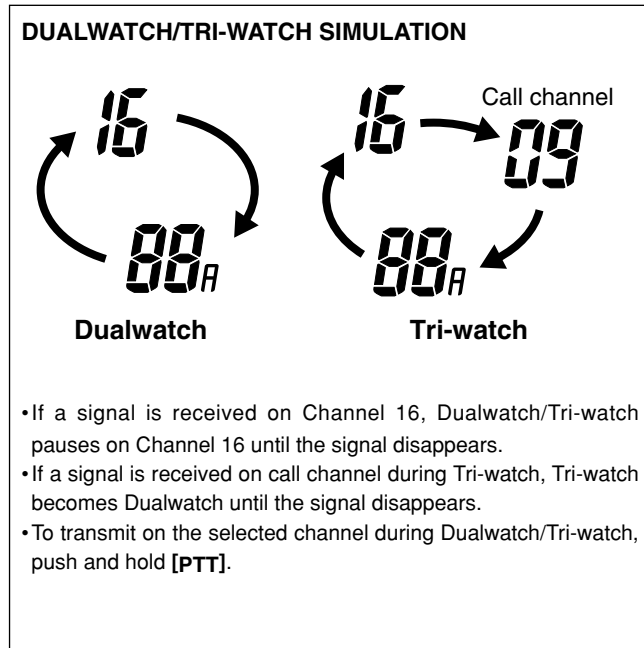

3.2 Operation

- ① Select Dualwatch or Tri-watch in Set mode. (p. 38)
- ② Select the desired operating channel.
- ③ Push **[CH/WX]** (**DW** **U/C**) for 1 sec. to start Dualwatch or Tri-watch.
 - “DUAL” appears during Dualwatch; “TRI” appears during Tri-watch.
 - A beep tone sounds when a signal is received on Channel 16.
- ④ To cancel Dualwatch or Tri-watch, push **[CH/WX]** (**DW** **U/C**) again.

[Example]: Operating Tri-watch on INT Channel 25.

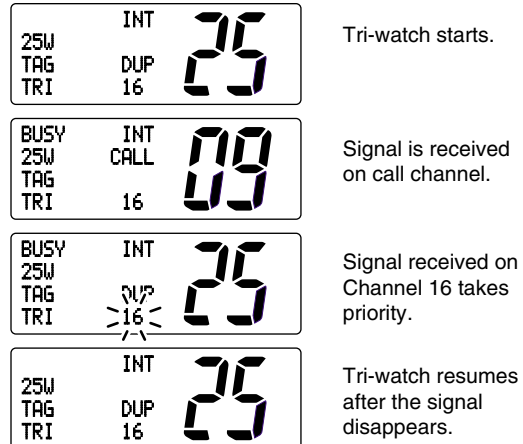

4. Scan Operation

4.1 Scan Types

Scanning is an efficient way to locate signals quickly over a wide frequency range. The transceiver has Priority scan and Normal scan.

When the Weather alert function is in use, the selected weather channel is checked while scanning. (p. 38)

Set the tag channels (scanned channel) before scanning. Clear the tag channels which inconveniently stop scanning, such as those for digital communication use.

Note: Choose Priority or Normal scan in Set mode. (p. 38)

PRIORITY SCAN

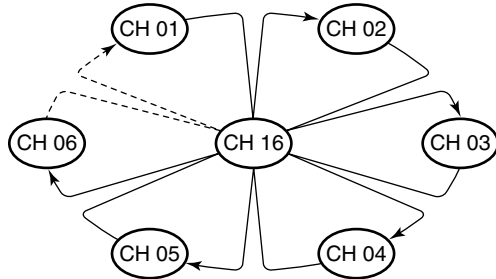

Priority scan searches through all tag channels in sequence while monitoring Channel 16. When a signal is detected on Channel 16, scan pauses until the signal disappears; when a signal is detected on a channel other than Channel 16, scan becomes Dualwatch until the signal disappears.

NORMAL SCAN

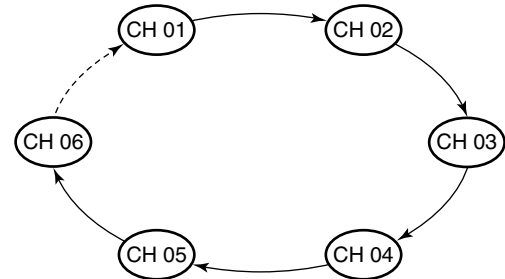

Normal scan, like Priority scan, searches through all tag channels in sequence. However, unlike Priority scan, Channel 16 is not checked unless Channel 16 is set as a tag channel.

4.2 Setting Tag Channels

For more efficient scanning, add desired channels as tag channels or clear tag channels for unwanted channels. Channels not tagged will be skipped during scanning. Tag channels can be assigned to each channel group (U.S.A., International, Canada) independently.

- ① While pushing [HI/LO], push [CH/WX] (DW U/I/C) one or more times to select the desired channel group.
- ② Select the desired channel to be set as a tag channel.
- ③ Push [SCAN] (TAG) for 1 sec. to set the displayed channel as a tag channel.
 - “TAG” appears in the display.
- ④ To cancel the tag channel setting, repeat step ③.
 - “TAG” disappears.

Convenient: Clearing (setting) all tagged channels

- ➔ While pushing [HI/LO], push [SCAN] (TAG) for 3 sec. (until a long beep changes to 2 short beeps) to clear all tag channels setting in the channel group.
 - Repeat above procedure to set all tag channels.

4.3 Starting a Scan

Set scan type (Priority or Normal scan) and scan resume timer in advance using Set mode. (p. 38)

- ① Set tag channels as described at left.
- ② Make sure the squelch is closed to start a scan.
- ③ While pushing [HI/LO], push [CH/WX] (DW U/I/C) one or more times to select the channel group, if desired.
- ④ Push [SCAN] to start Priority or Normal scan.
 - “Pri Scan 16” or “Normal Scan” appears in the function display.
 - When a signal is detected, scan pauses until the signal disappears or resumes after pausing 5 sec. according to Set mode setting. (Channel 16 is still monitored during Priority scan.)
 - Rotate [CHANNEL] to check the scanning tag channels, to change the scanning direction or resume the scan manually.
 - “16” blinks and a beep tone sounds when a signal is received on Channel 16 during Priority scan.
- ⑤ To stop the scan, push [SCAN].

[Example]: Starting a Normal scan.

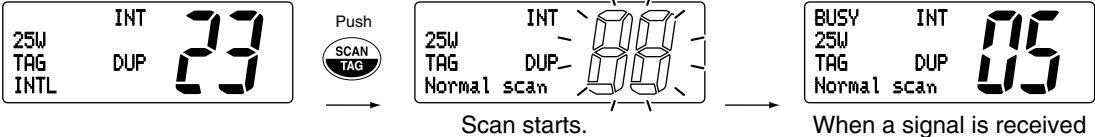

5. DSC Operation

5.1 MMSI Code Programming

The 9-digit MMSI (Maritime Mobile Service Identity: DSC self ID) code can be programmed at power ON.

Note: This function is not available when the MMSI code has been programmed by the dealer. This code programming can be performed only twice.

- ① Turn power OFF.
- ② While pushing **[DSC/ENT]**, turn power ON to enter MMSI code programming condition.
- ③ After the display appears, release **[DSC/ENT]**.

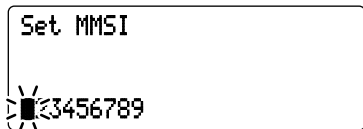

- ④ Edit the specific MMSI code by rotating **[CHANNEL]**.
 - Push **[CH/WX]** or **[SCAN]** to move the cursor forward or backward, respectively.
- ⑤ Input the 9 digit codes, then push **[DSC/ENT]** to set the code.
 - Returns to the normal operation.

5.2 DSC Individual ID

A total of 40 DSC address IDs can be programmed and named with up to 10 characters.

◆ Programming Address ID/Group ID

- ① Push **[DSC/ENT]** to enter the DSC menu.
- ② Rotate **[CHANNEL]** to select "Set up," push **[DSC/ENT]**.



- ③ Rotate **[CHANNEL]** to select "Add ID," push **[DSC/ENT]**.



5.DSC Operation

- ④ Set the individual ID and ID name.
- Edit the 9 digits of the appropriate distress ID by using **[CHANNEL]**.
 - Push **[CH/WX]** or **[SCAN]** to move the cursor forward or backward, respectively.

Note: 1st digit '0' is fixed for a group ID. Thus an address ID input cannot started with '0.' When you input 1st digit '0' and other 8 digits, the ID is automatically registered as a group ID.



- ⑤ Push **[DSC/ENT]** to program and exit the condition to the normal operation.

◆ Deleting Address ID/Group ID

- ① Push **[DSC/ENT]** to enter the DSC menu.
- ② Rotate **[CHANNEL]** to select "Set up," push **[DSC/ENT]**.
- ③ Rotate **[CHANNEL]** to select "Delete ID," push **[DSC/ENT]**.
 - When no address ID is programmed, the transceiver exits the DSC menu automatically.



- ④ Rotate **[CHANNEL]** to select the desired ID name for deleting.



- ⑤ The delete confirmation display will appear when **[DSC/ENT]** is pushed.
 - Push **[HI/LO]** to delete ID and exit the DSC Menu.
 - Push **[DSC/ENT]** to cancel deleting and exit the DSC Menu.

5.DSC Operation

5.3 Position and Time Programming

A distress call should include the ship's position and time. If no GPS is connected, your position and UTC (Universal Time Coordinated) time should be input manually. They are included automatically when a GPS receiver (NMEA0183 ver. 2.0 or 3.01) is connected.

Note: This manual programming is not available when a GPS receiver (NMEA0183 ver. 2.0 or 3.01) is connected.

- ① Push **[DSC/ENT]** to enter the DSC menu.
- ② "POS InPut" is selected automatically, push **[DSC/ENT]**.

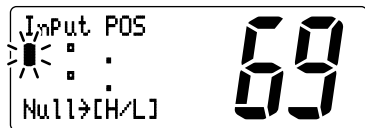

- ③ Edit the digit of your latitude data by using **[CHANNEL]**.
 - Push **[CH/WX]** or **[SCAN]** to move the cursor forward or backward, respectively.
 - After editing latitude data, select "N"; North latitude or "S"; South latitude.
 - Push **[HI/LO]** to clear the position data.

- ④ Edit the digit of your longitude data by using **[CHANNEL]**.
 - Push **[CH/WX]** or **[SCAN]** for cursor movement.
 - After editing longitude data, select "E"; East longitude or "W"; West longitude.
 - Push **[HI/LO]** to clear the position data.
- ⑤ Push **[DSC/ENT]** to set the position and advance to the time setting condition.
 - Push **[16]** or **[LO/DX]** to abandon the setting and exit the DSC menu.

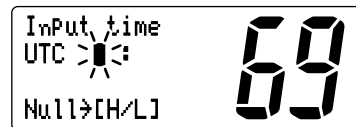

- ⑥ Edit the digit of the current UTC time by using **[CHANNEL]**.
 - Push **[CH/WX]** or **[SCAN]** for cursor movement.
 - Push **[HI/LO]** to clear the time data.
- ⑦ Push **[DSC/ENT]** to set the time, and exit the DSC menu.
 - Push **[16]** or **[LO/DX]** to abandon the setting and exit the DSC menu.

5.4 Position/Time Indication

When a GPS receiver (NMEA0183 ver. 2.0 or 3.01) is connected, the transceiver displays the current position and time. When no GPS receiver is connected, the transceiver displays the manually entered position and time.

A GPS receiver with NMEA0183 ver. 2.0 or 3.01 format is required for position indication. Ask your dealer about suitable GPS receivers.

➔ Push **[DSC/ENT] (POS)** for 1 sec. to display the current position and time.

• "MANL" (manual) appears instead of the "GPS" indication when no GPS is connected and the position/time data is entered manually.

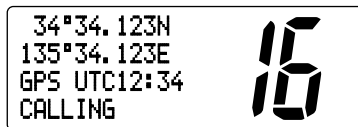

1. When connecting GPS receiver is compatible several sentence formatters, the order of input precedence is 'RMC,' 'GGA,' 'GNS' and 'GLL.'
2. When sentence formatter 'RMC' is received, time indication includes a date, and UTC time only.
3. "???" may blink instead of position and time indications when the GPS data is invalid, or has not been manually updated after 4 hours.

- Sentence formatter 'RMC'

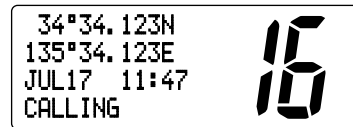

- Sentence formatters 'GGA,' 'GNS,' 'GLL'

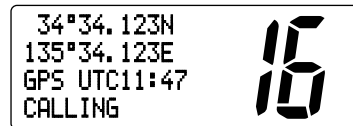

No offset time

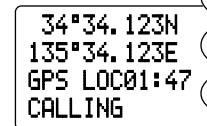

Offset time is
-10 hours. (p.33)

5.DSC Operation

5.5 Distress Call

A Distress call should be transmitted, if in the opinion of the Master, the ship or a person is in distress and requires immediate assistance.

Note: DO NOT USE THE DISTRESS CALL WHEN YOUR SHIP IS NOT IN AN EMERGENCY. A DISTRESS CALL CAN BE USED ONLY WHEN IMMEDIATE HELP IS NEEDED.

5.5.1 Simple call

- ① Confirm no Distress call is being received.
- ② While lifting up the switch cover, push **[DISTRESS]** for 5 sec. to transmit the Distress call.
 - Emergency channel (Ch 70) is automatically selected and the Distress call is transmitted.
 - When no GPS is connected, input your position and UTC time, if possible.

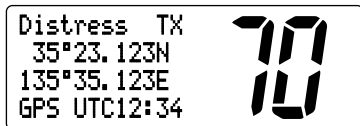

- ③ After transmitting the call, the transceiver waits for an acknowledgment call on Ch 70.
 - The Distress call is automatically transmitted every 3.5 to 4.5 minutes.

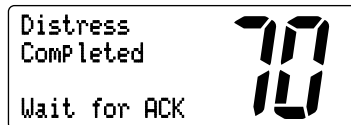

- ④ When receiving the acknowledgment, reply using the microphone.

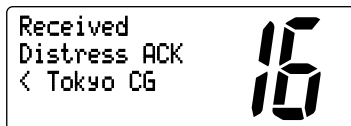

1. A distress alert contains (default);
 - Kind of distress : Undesignated distress
 - Position data : GPS or manual input position data held for 23.5 hrs or until the power is turned OFF.
2. The Distress call is repeated every 3.5–4.5 min., until receiving an 'acknowledgement.'
3. Push **[DISTRESS]** to transmit a renewed Distress call, if required.
4. Push any key (except **[DISTRESS]**) to cancel the 'Call repeat' mode.
5. "???" may blink instead of position and time indications when the GPS data is invalid, or has not been manually updated after 4 hours.

5.DSC Operation

5.5.2 Normal call

The nature of the Distress call should be included in the Distress call.

- ① Push **[DSC/ENT]** to enter the DSC menu.
- ② Rotate **[CHANNEL]** to select "DTRS Set," push **[DSC/ENT]**.



- ③ Rotate **[CHANNEL]** to select the nature of the distress, push **[DSC/ENT]**.
 - 'Undesignated,' 'Explosion,' 'Flooding,' 'Collision,' 'Grounding,' 'Capsizing,' 'Sinking,' 'Adrift (Disable adrift),' 'Abandoning (Abandoning ship),' 'Piracy (Piracy attack)' and 'MOB (Man overboard)' are available.
 - The selected nature of the distress is stored for 10 minutes after programming is finished.



Note: When a GPS receiver (NMEA0183 ver. 2.0 or 3.01) is connected, next steps ④, ⑤ (Current position/time programming) do not appear. Go to step ⑥. (next page)

- ④ The position information appears. Set the current position, push **[DSC/ENT]**.

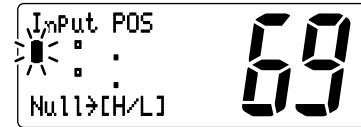

- Edit the digit of your position data by using **[CHANNEL]**.
 - Push **[CH/WX]** or **[SCAN]** for cursor movement.
 - After editing latitude data, select "N"; North latitude or "S"; South latitude.
 - After editing longitude data, select "E"; East longitude or "W"; West longitude.
 - Push **[HI/LO]** to clear the position data.

- ⑤ The time information appears. Set the current UTC time, push **[DSC/ENT]**.

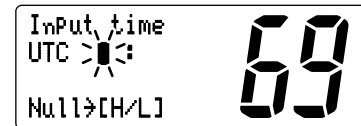

- Edit the digit of the current UTC time by using **[CHANNEL]**.
 - Push **[CH/WX]** or **[SCAN]** for cursor movement.
 - Push **[HI/LO]** to clear the time data.

5.DSC Operation

- ⑥ Push **[DISTRESS]** for 5 sec. to transmit the Distress call.



- ⑦ After transmitting the call, the transceiver waits for an acknowledgment call on Ch 70.
- The Distress call is automatically transmitted every 3.5 to 4.5 minutes.



- ⑧ When receiving the acknowledgment, reply using the microphone.

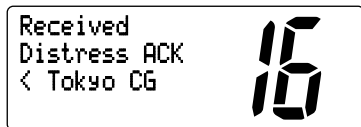

1. A distress alert contains (default);
 - Kind of distress : Selected nature of the distress.
 - Position data : GPS or manual input position data held for 23.5 hrs or until the power is turned OFF.
2. The Distress call is repeated every 3.5–4.5 min., until receiving an 'acknowledgement.'
3. Push **[DISTRESS]** to transmit a renewed Distress call, if required.
4. Push any key (except **[DISTRESS]**) to cancel the 'Call repeat' mode.
5. "??" may blink instead of position and time indications when the GPS data is invalid, or has not been manually updated after 4 hours.

5.6 Transmitting DSC Calls

5.6.1 Transmitting Individual call

The Individual call function allows you to transmit a DSC signal to a specific ship only.

- ① Push **[DSC/ENT]** to enter the DSC menu.
- ② Rotate **[CHANNEL]** to select "Individual," push **[DSC/ENT]**.



- ③ Rotate **[CHANNEL]** to select the desired pre-programmed individual address or "Manual InPut," push **[DSC/ENT]**.
 - The ID code for the Individual call can be set in advance. (p. 13)
 - When "Manual InPut" is selected, set the 9-digit ID code (1st digit must not be '0') for the individual you wish to call by using **[CHANNEL]**.

- Push **[CH/WX]** or **[SCAN]** for cursor movement.
- After 9-digit is input, push **[DSC/ENT]** to set the ID code.



- ④ Rotate **[CHANNEL]** to select a desired intership channel or "Manual InPut," push **[DSC/ENT]**.
 - When "Manual InPut" is selected, rotate **[CHANNEL]** to select the desired channel other than Channel 70, push **[DSC/ENT]**.



- ⑤ Push **[DSC/ENT]** to transmit the Individual call.
 - If Channel 70 is busy, the transceiver stands by until the channel becomes clear.

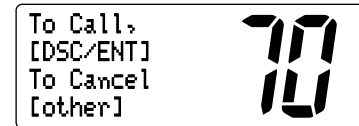

Push **[DSC/ENT]** to transmit DSC call.

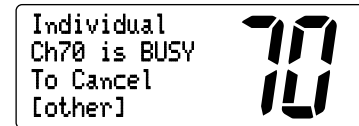

When Ch 70 is busy.

5.DSC Operation

- ⑥ After transmitting the Individual call, standby on Channel 70 until an acknowledgement is received.

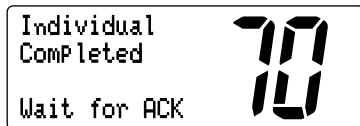

- ⑦ When the acknowledgement is received, the display changes to the previously selected channel with beeps.

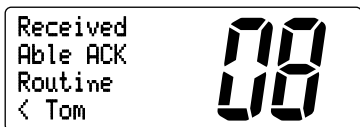

- ⑧ Push and hold [PTT] to communicate your message to the responding ship.

5.6.2 Transmitting Individual acknowledgement

Transmit an acknowledgement ('able to comply' or 'unable to comply') when an Individual call for you is received.

- ① Push [DSC/ENT] to enter the DSC menu.
② Rotate [CHANNEL] to select "INDU ACK," push [DSC/ENT].

• "INDU ACK" item appears after an Individual call is received.



- ③ Rotate [CHANNEL] to select the desired individual address or ID code, push [DSC/ENT].



5.DSC Operation

- ④ Rotate **[CHANNEL]** to select an acknowledgement "Able" or "Unable," push **[DSC/ENT]**.



- ⑤ If you select "Unable," select the reason by rotating **[CHANNEL]**, push **[DSC/ENT]**.

• 'No reason given,' 'Congestion,' 'Busy,' 'Queue indication,' 'Station Barred,' 'No operator,' 'Operator Unavailable,' 'Equipment Disable,' 'Channel Unavailable' and 'Mode Unavailable' are available.



- ⑥ Push **[DSC/ENT]** to transmit the acknowledgement to the selected station.



- ⑦ After the Individual acknowledgement has been transmitted, the display changes to the channel specified by the calling station, automatically.



5.DSC Operation

5.6.3 Transmitting Group call

The Group call function allows you to transmit a DSC signal to a specific group only.

- ① Push **[DSC/ENT]** to enter the DSC menu.
- ② Rotate **[CHANNEL]** to select "Group," push **[DSC/ENT]**.



- ③ Rotate **[CHANNEL]** to select the desired pre-programmed group address or "Manual Input," push **[DSC/ENT]**.
 - The ID code for the Group call can be set in advance. (p. 13)
 - When "Manual Input" is selected, set the 9-digit ID code (must be set to '0') for the group you wish to call by using **[CHANNEL]**.
 - Push **[CH/WX]** or **[SCAN]** for cursor movement.
 - After 9-digit is input, push **[DSC/ENT]** to set the ID code.



- ④ Rotate **[CHANNEL]** to select a desired intership channel or "Manual Input," push **[DSC/ENT]**.
 - When "Manual Input" is selected, rotate **[CHANNEL]** to select the desired channel other than Channel 70, push **[DSC/ENT]**.



- ⑤ Push **[DSC/ENT]** to transmit the Group call.
 - If Channel 70 is busy, the transceiver stands by until the channel becomes clear.

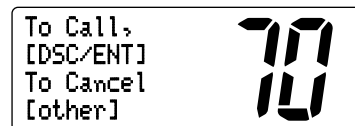

- ⑥ After the Group call has been transmitted, the display changes to the previously selected channel.

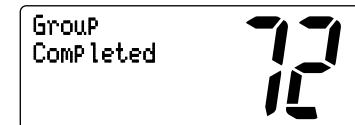

- ⑦ Push and hold **[PTT]** to communicate your message to the responding ship or push **[DSC/ENT]** to exit the condition.

5.DSC Operation

5.6.4 Transmitting All Ships call

Large ships use Channel 70 as their 'listening channel.' When you want to announce a message to these ships, use the 'All Ships Call' function.

- ① Push **[DSC/ENT]** to enter the DSC menu.
- ② Rotate **[CHANNEL]** to select "All Ships," push **[DSC/ENT]**.



- ③ Push **[DSC/ENT]** to transmit the All Ships call.
 - Channel 70 is selected and the All Ships call is transmitted.
 - Routine category only is available.

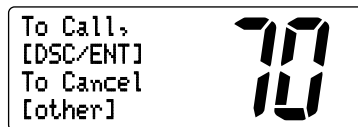

- ④ After the All Ships call has been transmitted, the display changes to Channel 16 automatically.

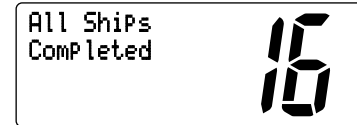

- ⑤ Push any key to exit the condition and the display returns to the normal operation.

5.DSC Operation

5.6.5 Transmitting Position Request call

Transmit a Position Request call when you want to know a specific ship's current position, etc.

- ① Push **[DSC/ENT]** to enter the DSC menu.
- ② Rotate **[CHANNEL]** to select "POS Request," push **[DSC/ENT]**.



- ③ Rotate **[CHANNEL]** to select the desired pre-programmed individual address or "Manual Input," push **[DSC/ENT]**.
 - The ID code for the Position Request call can be set in advance. (p. 13)
 - When "Manual Input" is selected, set the 9-digit ID code (1st digit must not be '0') for the individual you wish to call by using **[CHANNEL]**.
 - Push **[CH/WX]** or **[SCAN]** for cursor movement.
 - After 9-digit is input, push **[DSC/ENT]** to set the ID code.



- ④ Push **[DSC/ENT]** to transmit the Position Request call.

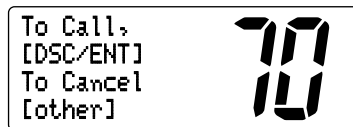

- ⑤ After the Position Request call has been transmitted, the following indication is displayed.

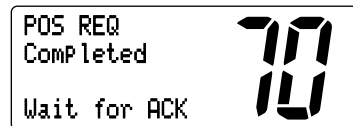

- ⑥ Push any key to exit the condition and return to the normal operation.

5.DSC Operation

5.6.6 Transmitting Position Report call

Transmit a Position Report call when you want to announce your own position to a specific ship and to get answer, etc.

- ① Push **[DSC/ENT]** to enter the DSC menu.
- ② Rotate **[CHANNEL]** to select "POS Report," push **[DSC/ENT]**.



- ③ Rotate **[CHANNEL]** to select the desired pre-programmed individual address or "Manual Input," push **[DSC/ENT]**.
 - The ID code for the Position Report call can be set in advance. (p. 13)
 - When "Manual Input" is selected, set the 9-digit ID code (1st digit must not be '0') for the individual you wish to call by using **[CHANNEL]**.
 - Push **[CH/WX]** or **[SCAN]** for cursor movement.
 - After 9-digit is input, push **[DSC/ENT]** to set the ID code.



Note: When a GPS receiver (NMEA0183 ver. 2.0 or 3.01) is connected, next steps ④, ⑤ (Current position/time programming) do not appear. Go to step ⑥. (next page)

- ④ The position information appears. Set the current position, push **[DSC/ENT]**.

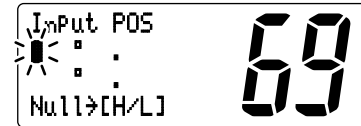

- Edit the digit of your position data by using **[CHANNEL]**.
 - Push **[CH/WX]** or **[SCAN]** for cursor movement.
 - After editing latitude data, select "N"; North latitude or "S"; South latitude.
 - After editing longitude data, select "E"; East longitude or "W"; West longitude.
 - Push **[HI/LO]** to clear the position data.

- ⑤ The time information appears. Set the current UTC time, push **[DSC/ENT]**.

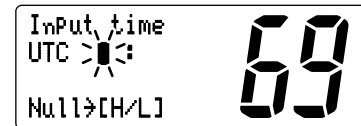

- Edit the digit of the current UTC time by using **[CHANNEL]**.
 - Push **[CH/WX]** or **[SCAN]** for cursor movement.
 - Push **[HI/LO]** to clear the time data.

5.DSC Operation

- ⑥ Push **[DSC/ENT]** to transmit the Position Report call.

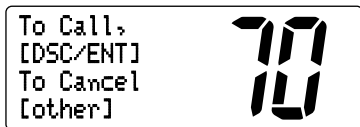

- ⑦ After the Position Report call has been transmitted, the following indication is displayed



- ⑧ Push any key to exit the condition and return to the normal operation.

5.6.7 Transmitting Position Reply call

Transmit a Position Reply call when a Position Request call is received.

- ① When a Position Request call is received, the following indication is displayed.



- ② Push **[DSC/ENT]** to reply to the Position Request call; push other key to ignore the Position Request call.

5.6.8 Transmitting Position Report Reply call

Transmit a Position Report Reply call when a Position Report call is received.

- ① When a Position Report call is received, the following indication is displayed.



- ② Push **[DSC/ENT]** to reply to the Position Report call; push any key to ignore the Position Report call.

5.7 Receiving DSC Calls

5.7.1 Receiving a Distress call

While monitoring Channel 70 and a Distress call is received:

- ➔ The emergency alarm sounds for 2 minutes.
 - Push any key to stop the alarm.
- ➔ “Received Distress” appears in the display; then Channel 16 is automatically selected.
- ➔ Continue monitoring Channel 16 as a coast station may require assistance.

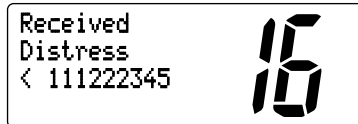

5.7.2 Receiving a Distress acknowledgement

While monitoring Channel 70 and a Distress acknowledgement to other ship is received:

- ➔ The emergency alarm sounds for 2 minutes.
 - Push any key to stop the alarm.
- ➔ “Received Distress ACK” appears in the display; then Channel 16 is automatically selected.

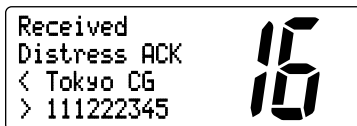

5.7.3 Receiving an Individual call

While monitoring Channel 70 and an Individual call is received:

- ➔ The emergency alarm or beeps sound depending on the received category.
- ➔ “Received Individual” appears in the display.

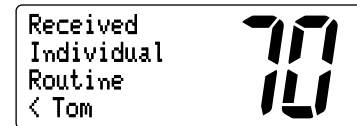

- ➔ Push **[DSC/ENT]** to change to the channel specified by the calling station for voice communication; push other key to ignore the Individual call.

5.7.4 Receiving a Group call

While monitoring Channel 70 and a Group call is received:

- ➔ The emergency alarm or beeps sound depending on the received category.
- ➔ “Received Group” appears in the display.

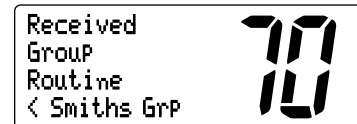

- ➔ Push **[DSC/ENT]** to change to the channel specified by the calling station for voice communication; push other key to ignore the Group call.

5.DSC Operation

5.7.5 Receiving an All Ships call

While monitoring Channel 70 and an All Ships call is received:

- ➔ Emergency alarm sounds when the category is 'Distress' or 'Urgency'; 3 beeps sound for other categories.
- ➔ "Received All ships" appears in the display.



- ➔ Push **[DSC/ENT]** to change to the channel specified by the calling station for voice communication; push other key to ignore the All Ships call.
- ➔ Monitor the channel for an announcement from the calling vessel.

5.7.6 Receiving a Distress Relay call

While monitoring Channel 70 and a Distress Relay call is received:

- ➔ Emergency alarm sounds for 2 minutes.
 - Push any key to stop the alarm.
- ➔ "Received Distress RLY" appears in the display; then, Channel 16 is automatically selected.
- ➔ Monitor Channel 16 until the emergency communication has been completed.

5.7.7 Receiving a Distress Relay acknowledgement

While monitoring Channel 70 and a Distress Relay acknowledgement is received:

- ➔ Emergency alarm sounds for 2 minutes.
 - Push any key to stop the alarm.
- ➔ "Received DTRS RLY ACK" appears in the display; then, Channel 16 is automatically selected.

5.7.8 Receiving a Geographical Area call

While monitoring Channel 70 and a Geographical Area call (for the area you are in) is received:

- ➔ Emergency alarm or beeps sound depending on the received category.
- ➔ "Received Geographic" appears in the display.
- ➔ Push **[DSC/ENT]** to change to the channel specified by the calling station for voice communication; push other key to ignore the Geographical Area call.
- ➔ Monitor the selected channel for an announcement from the calling station.



Note: When no GPS receiver is connected or if there is a problem with the connected receiver, all Geographical Area calls are received, regardless of your position.

5.DSC Operation

5.7.9 Receiving a Position Request call

While monitoring Channel 70 and a Position Request call is received:

➔ "Received POS Request" appears in the display.



➔ Push [DSC/ENT] to reply to the Position Request call; push other key to ignore the Position Request call.

5.7.10 Receiving a Position Reply call

While monitoring Channel 70 and a Position Reply call is received:

➔ "Received POS" appears in the display.



5.7.11 Receiving a Position Report call

While monitoring Channel 70 and a Position Report call is received:

➔ "Received POS Report" appears in the display.



➔ Push [DSC/ENT] to reply to the call; push other key to ignore the Position Report call.

5.7.12 Receiving a Position Report Reply call

While monitoring Channel 70 and a Position Report Reply call is received:

➔ "Received POS" appears in the display.

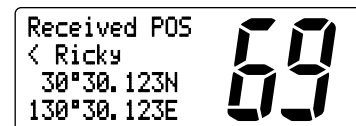

5.DSC Operation

5.8 Received Messages

The transceiver automatically stores up to 20 distress messages and 20 other messages. The messages can be used as an assistance to the logbook.

- ① Push **[DSC/ENT]** to select the DSC menu.
- ② Rotate **[CHANNEL]** to select "RCV Calls," push **[DSC/ENT]**.



5.8.1 Distress message

- ① Rotate **[CHANNEL]** to select "Distress," push **[DSC/ENT]**.



- ② Rotate **[CHANNEL]** to scroll to the desired message, push **[DSC/ENT]**.
 - When some messages are blinking, the messages have not been read.



- ③ Rotate **[CHANNEL]** to scroll the message.

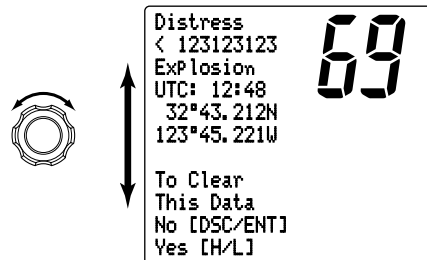

- ④ Push **[DSC/ENT]** to exit the DSC menu or push **[HI/LO]** to clear the displayed message and returns to the normal operation.

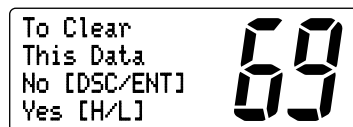

5.DSC Operation

5.8.2 Other messages

- ① Rotate [CHANNEL] to select "Other," push [DSC/ENT].

```
Sel Messege
Distress
→Other      69
```

- ② Rotate [CHANNEL] to scroll to the desired message, push [DSC/ENT].

•When some messages are blinking, the messages have not been read.

```
Sel Messege
All Ships
→Individual
POS Request  69
```

- ③ Rotate [CHANNEL] to scroll the message.

•The stored message has various information and depending on the type of distress calls.



```
All Ships
< Tom
Routine
F3E Simplex
CH08      69

To Clear
This Data
No [DSC/ENT]
Yes [H/L]
```

- ④ Push [DSC/ENT] to exit the DSC menu or push [HI/LO] to clear the displayed message and returns to the normal operation.

```
To Clear
This Data
No [DSC/ENT]
Yes [H/L]      69
```

5.DSC Operation

5.9 DSC Set Mode

5.9.1 Add Address ID (See p.13 for detail)

5.9.2 Delete Address ID (See p.14 for detail)

5.9.3 Offset time

This item sets the offset time from the UTC (Universal Time Coordinated) time.

- ① Push **[DSC/ENT]** to enter the DSC menu.
- ② Rotate **[CHANNEL]** to select "Set up," push **[DSC/ENT]**.



- ③ Rotate **[CHANNEL]** to select "Offset time," push **[DSC/ENT]**.

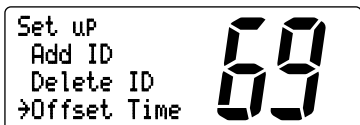

- ④ Set the offset time from the UTC (Universal Time Coordinated) time.
 - Edit the digit of offset time by using **[CHANNEL]**.
 - Push **[CH/WX]** or **[SCAN]** for cursor movement.
 - Push **[DSC/ENT]** to set the offset time.
 - Rotate **[CHANNEL]** to edit or delete "—," when the cursor is on the first digit.



No offset time (default)

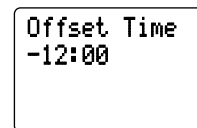

-12 hours

- ⑤ Push **[DSC/ENT]** to program and to exit the DSC menu.

Note: The local time indication is not available when a GPS receiver (sentence formatter 'RMC') is input, the transceiver's display indicates UTC time only.

5.9.4 MMSI code check

The programmed 9-digit MMSI (DSC self ID) code can be checked in DSC Set mode.

- ① Push **[DSC/ENT]** to enter the DSC menu.
- ② Rotate **[CHANNEL]** to select "Set up," push **[DSC/ENT]**.



- ③ Rotate **[CHANNEL]** to select "MMSI Check," push **[DSC/ENT]**.



- ④ Check the 9-digit MMSI (DSC self ID) code.



- ⑤ Push **[DSC/ENT]** to exit the DSC menu.

6. Other Functions

6.1 Intercom Operation

The optional Intercom function allows you to talk to the deck from the cabin. The optional FM-3010 CONTROLLABLE MIC is required for Intercom operation.

Connect an optional FM-3010 as described on pgs. 41, 64.

- Transmitting is impossible during Intercom operation.
- The received signal is muted during Intercom operation.

- ① Push **[LO/DX]** (**[IC]** **[SCR]**) for 1 sec. to enter Intercom mode.
 - The FM-3010 power is automatically turned ON, even if the power is OFF.

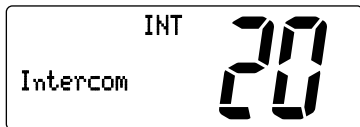

FM-3000

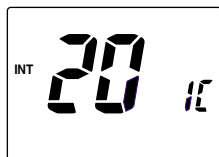

FM-3010

- ② Push and hold **[LO/DX]** (**[IC]** **[SCR]**) again to call **up**.
 - The transceiver and microphone emit call beeps.
- ③ Push and hold the PTT switch and speak at a normal voice level into the microphone.
 - "TALK" or "LSTN" appears on the caller or listener function display, respectively.
 - To adjust the FM-3000's speaker output level, rotate **[VOL]**.
 - To adjust the FM-3010's speaker output level, push after **[VOL]** pushing **[▲]**/**[▼]**.

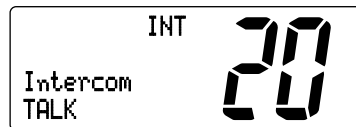

FM-3000 (caller)



FM-3010 (listener)

- ④ After releasing the PTT switch you can hear the response through the speaker.
- ⑤ To return to the normal operation, push **[LO/DX]** (**[IC]** **[SCR]**) momentarily.
 - Other keys also turn the function OFF, however, the corresponding function is then activated (e.g. pushing **[16]** (**[9]**) selects Channel 16).

1. While in the Intercom mode, the transceiver functions (transmit and receive) are interrupted. If the transceiver is in transmit condition, the Intercom function is not available.
2. When a DSC call is received, "DSC received" appears and the last received DSC message is displayed after the Intercom use is finished.
3. When a WX alert is received, "WX ALT" blinks and a beep sounds. The WX alert sounds after the Intercom use is finished.

6.2 Microphone Lock Function

The Microphone lock function electrically locks the [▲]/[▼] and [16/9] keys on the supplied microphone. This prevents accidental channel changes and accidental function access.

- ➔ While pushing [16/9] on supplied microphone, turn power ON to toggle the Lock function ON or OFF.

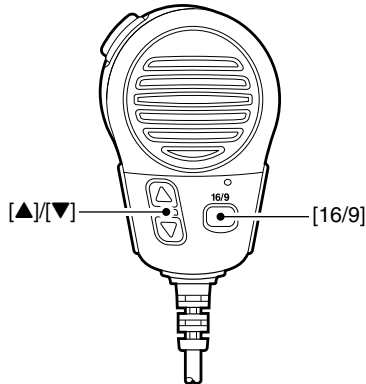

6.3 Display Backlighting

The function display and keys can be backlit for better visibility under low light conditions.

- ➔ While pushing [HI/LO], rotate [CHANNEL] to adjust the brightness of the LCD and key backlight.
 - The backlight level is adjustable in 7 levels.

7. Set Mode

7.1 Set Mode Programming

Set mode is used to change the conditions of the transceiver's functions: scan mode (Normal or Priority), scan resume timer, weather alert, Dualwatch/Tri-watch selection, DSC watch, transceiver's beep tone (transceiver or FM-3010), internal speaker, LCD contrast (transceiver or FM-3010), RF attenuation level, scrambler code and automatic acknowledgement.

1. Available functions may differ depending on dealer setting.
2. The optional FM-3010 has its own settings for the beep tone and LCD contrast.

- ① Turn power OFF.
- ② While pushing **[16]** (**9**), turn power ON to enter Set mode.
- ③ After the display appears, release **[16]** (**9**).
- ④ Push **[16]** (**9**) to select the desired item.
Or push **[16]** (**9**) on the FM-3010 to select the item when using an optional FM-3010.
- ⑤ Rotate **[CHANNEL]** to select the desired condition of the item. Use **[▲]/[▼]** when using an optional FM-3010.
- ⑥ Turn power OFF, then turn ON again to exit Set mode

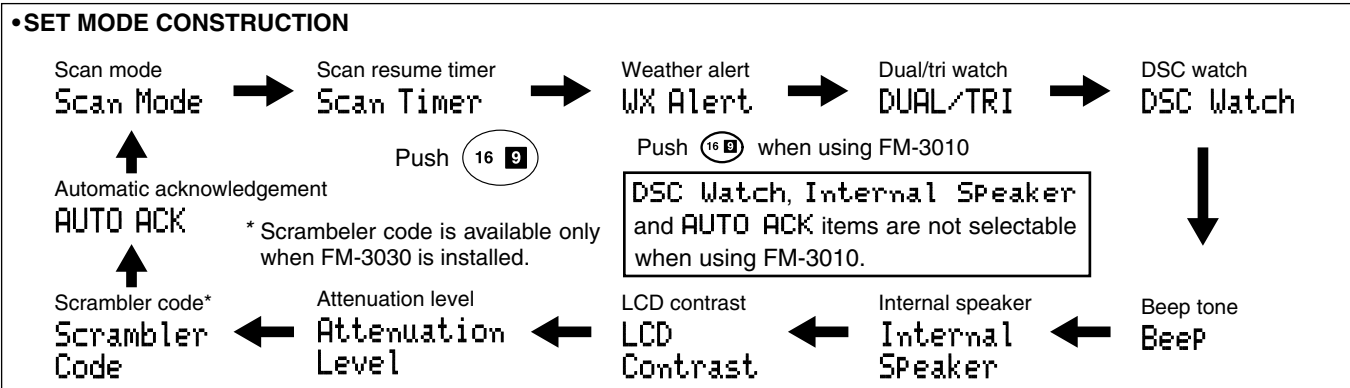

7.2 Set Mode Items

7.2.1 Scan mode

The transceiver has 2 scan modes: Normal scan and Priority scan. Normal scan searches all tag channels in the selected channel group. Priority scan searches all tag channels in sequence while monitoring Channel 16.

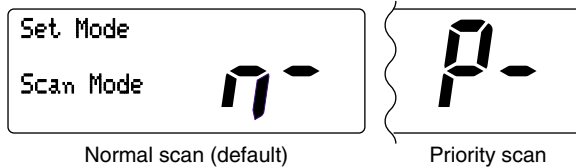

7.2.2 Scan resume timer

The scan resume timer can be selected as a pause (OFF) or timer scan (ON). When OFF is selected, the scan pauses until the signal disappears. When ON is selected, the scan pauses 5 sec. and resumes even if a signal has been received on channels any other channel than Channel 16.

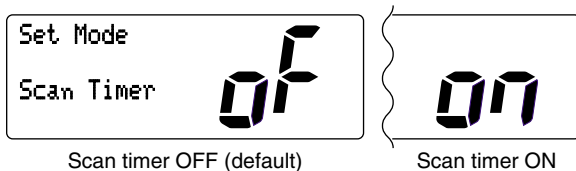

7.2.3 Weather alert

A NOAA broadcast station transmits a Weather alert tone before important weather information. When the Weather alert function is turned ON, the transceiver detects the alert tone, then blinks the "WX ALT" indicator and sounds beep tones until the transceiver is operated. The previously selected (used) weather channel is checked any time during standby or while scanning.

- "WX ALT" appears instead of "WEATHER" indication when the function is set ON.

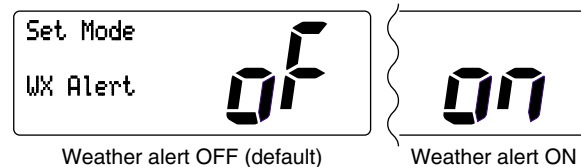

7.2.4 Dual/Tri-watch

This item sets the [CH/WX] (DW UWC) key function as Dual-watch or Tri-watch.

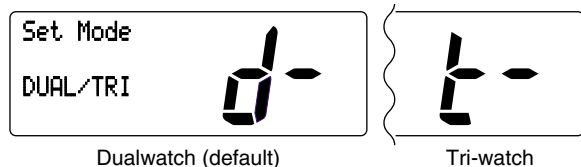

7.Set Mode

7.2.5 DSC watch

DSC watch monitors Channel 70 while you are receiving another channel. If a distress signal is received on Channel 70, the transceiver monitors Channel 16 and 70 alternately until the distress signal disappears. If a signal is received on another channel, DSC watch pauses until the signal disappears.

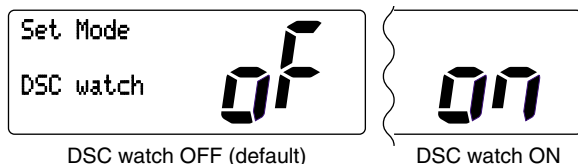

Note: This function may not be available for some channel groups depending on dealer setting.

7.2.6 Beep tone

You can select silent operation by turning beep tones OFF, or you can have confirmation beeps sound at the push of a key by turning beep tones ON.

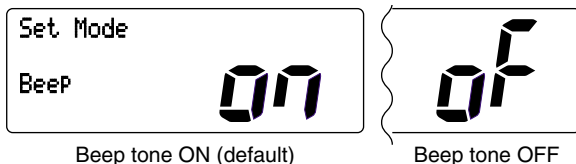

Note: The optional FM-3010 has its own setting for the beep tone.

7.2.7 Internal speaker

When an external speaker is connected and the transceiver's internal speaker is not required, the speaker on the transceiver and microphone can be deactivated.

"SP OFF" appears on the function display when the internal speaker is turned OFF.

•The order of indication precedence is "SP OFF," "LOCAL" and "CALL"

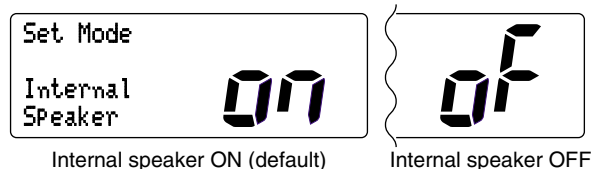

7.2.8 LCD contrast

This item adjusts the contrast of the LCD in 8 steps.

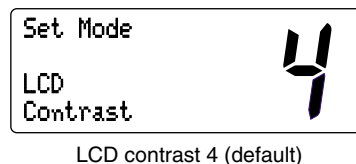

Note: The optional FM-3010 has its own setting for the LCD contrast.

7.Set Mode

7.2.9 Attenuation level

This item sets the receive attenuation level for the Attenuator function from 3 levels.

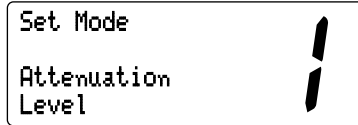

Attenuation level 1 (default)

7.2.10 Scrambler code

(Appears only when a scrambler unit is installed)

When an optional scrambler unit is installed, the scrambler code can be set depending on dealer setting.

When the FM-3030 is installed, 32 codes (1 to 32) can be selected.

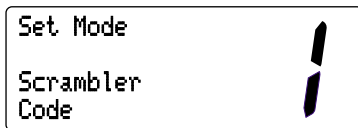

Scrambler code 1 (default)

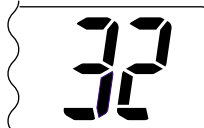

Scrambler code 32

7.2.11 Automatic acknowledgement

This item sets the Automatic acknowledgement function ON or OFF.

When Position Request or Position Report call is received, transceiver automatically transmits Position Reply or Position Report Reply, respectively.

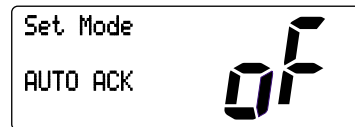

Auto ACK OFF (default)



Auto ACK ON

8. Connections and Maintenance

8.1 Antenna

A key element in the performance of any communication system is an antenna. Ask your dealer about antennas and the best place to mount them.

8.2 Fuse Replacement

One fuse is installed in the supplied DC power cable. If a fuse blows or the transceiver stops functioning, track down the source of the problem, if possible, and replace the damaged fuse with a new, rated one.

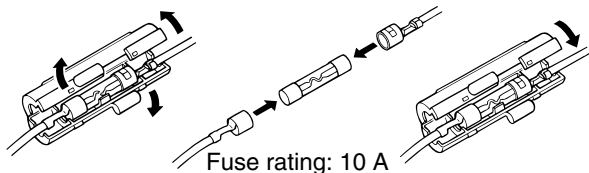

8.3 Cleaning

If the transceiver becomes dusty or dirty, wipe it clean with a soft, dry cloth.



AVOID the use of solvents such as benzene or alcohol, as they may damage transceiver surfaces.

8.4 Connections

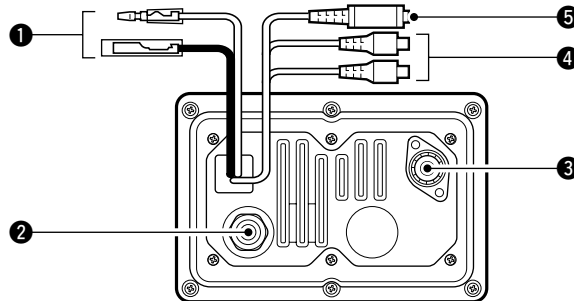

❶ DC POWER CONNECTOR

Connects the supplied DC power cable from this connector to an external 13.8 V DC power source.

❷ EXTERNAL MICROPHONE JACKS

Connects to optional FM-3010 CONTROLLABLE MIC.

⚠ CAUTION

NEVER connect other microphones, this may cause damage to the transceiver.

8.Connections and Maintenance

③ ANTENNA CONNECTOR

Connects a marine VHF antenna with a PL-259 connector.

⚠ CAUTION

Transmitting without an antenna may damage the transceiver.

④ NMEA IN (Red)/NMEA OUT (White) JACKS

Connects to a GPS receiver for position and time indications.

- An NMEA0183 ver. 2.0 or 3.01 (sentence formatters RMC, GGA, GNS, GLL) compatible GPS receiver is required. Ask your dealer about suitable GPS receivers.

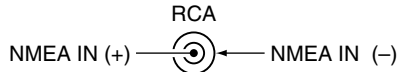

Connects to a PC or navigation equipment (NMEA0183 ver. 3.01 sentence formatters DSC, DSE compatible) for plotting received other ships position data.

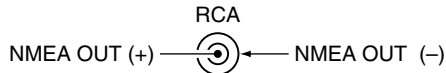

⑤ EXTERNAL SPEAKER JACK

↳Connects to an external speaker.

⚠ CAUTION

After connecting the DC power cable, NMEA IN/OUT jacks and external speaker jack cover the connector and jacks with a rubber vulcanising tape as shown below, to prevent water seeping into the transceiver.

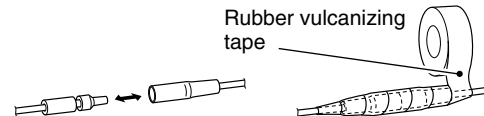

8.Connections and Maintenance

8.5 Mounting the Transceiver

8.5.1 Using the supplied mounting bracket

The universal mounting bracket supplied with your transceiver allows overhead or onboard mounting.

- Mount the transceiver securely with the 4 supplied screws (M5 × 20) to a surface which is more than 10 mm thick and can support more than 5 kg.
- Mount the transceiver so that the face of the transceiver is at 90° to your line of sight when operating it.

⚠ CAUTION

KEEP the transceiver and microphone at least 1 meter away from your vessel's magnetic navigation compass.

Note: Check the installation angle; the function display may not be easy-to-read at some angles.

• OVERHEAD MOUNTING

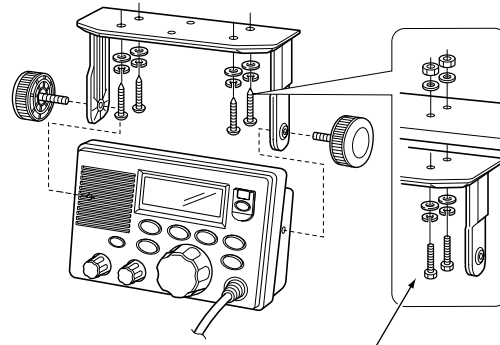

These screws are shown as mounting example only.
Not supplied with accessories.

• MOUNTING ON THE BOARD

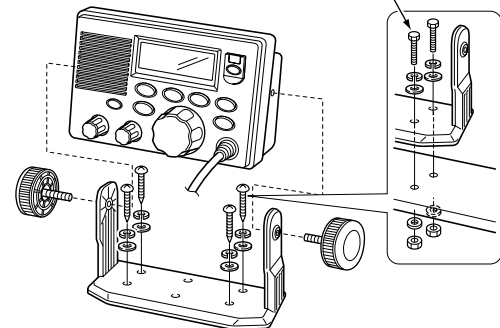

8.Connections and Maintenance

8.5.2 Using the optional FM-3040

An optional FM-3040 FLUSH MOUNT is available for mounting the transceiver to a flat surface such as an instrument panel.

⚠ CAUTION

KEEP the transceiver and microphone at least 1 meter away from your vessel's magnetic navigation compass.

- ① Using the template on the last page, carefully cut a hole into the instrument panel (or wherever you plan to mount the transceiver).
- ② Slide the transceiver through the hole as shown below.

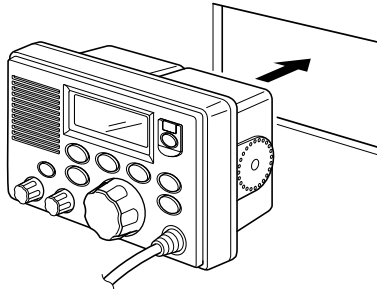

- ③ Attach the 2 supplied bolts (M5 × 8 mm) on either side of the FM-3000.

- ④ Attach the clamps on either side of the FM-3000.
 - Make sure that the clamps align parallel to the FM-3000's body.

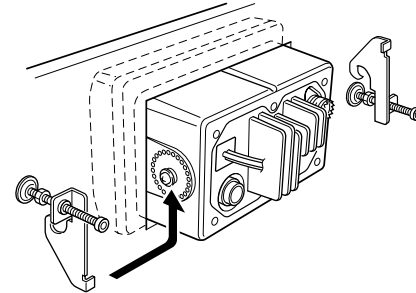

- ⑤ Tighten the end bolts on the clamps (rotate clockwise) so that the clamps press firmly against the inside of the instrument control panel.
- ⑥ Tighten the locking nuts (rotate counterclockwise) so that the FM-3000 is securely mounted in position as below.
- ⑦ Connect the antenna and power cable, then return the instrument control panel to its original place.

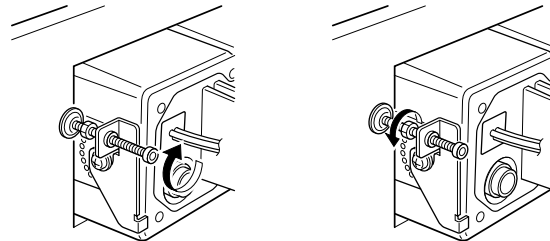

8.Connections and Maintenance

8.6 Optional Unit Installation

⚠CAUTION

DISCONNECT the DC power cable from the transceiver before performing any work on the transceiver. Otherwise, there is danger of electric shock and/or equipment damage.

Follow the case opening procedure shown here when you want to install an optional unit.

- ① Remove the 6 screws as shown below and open the transceiver.

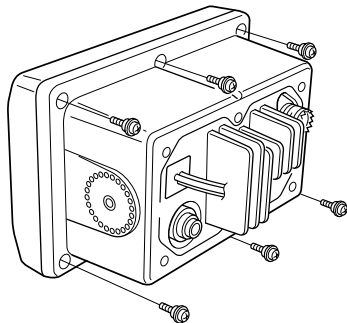

- ② Remove the 4 screws from the shielding plate, then lift up the shielding plate.

- ③ Plug an optional unit (FM-3030) to J3 on the MAIN unit as shown below.

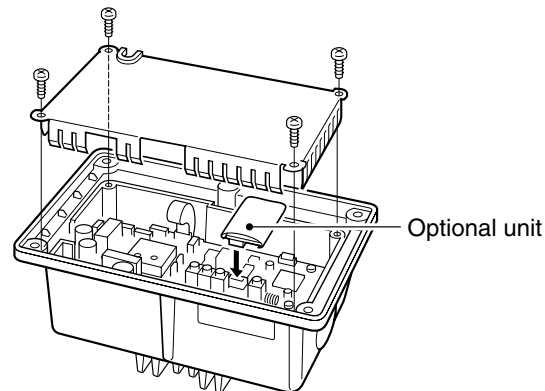

- ④ Return the shielding plate and assemble the units to their original positions.

⚠CAUTION

1. When re-assembling the case and tightening the screws, you must keep the specified torque (0.7 ± 0.1 N.m). Otherwise the transceiver may be damaged (torque too high) or lose waterproof efficiency (torque too low).
2. When uninstalling the optional unit, remove it vertically. Wiggling the unit from side to side may damage the optional unit's connector.

8.Connections and Maintenance

8.7 Dimensions

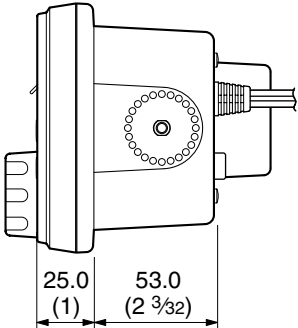
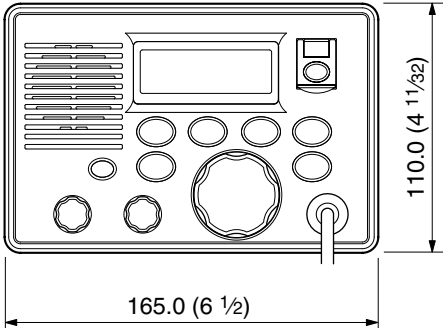
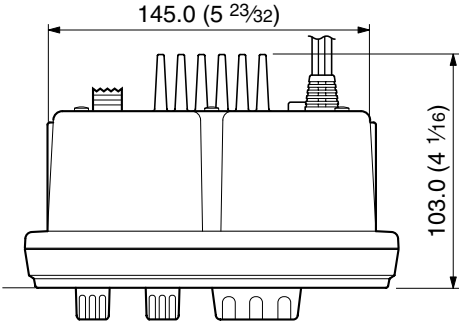

Unit: mm (in)

9. Troubleshooting

PROBLEM	POSSIBLE CAUSE	SOLUTION	REF.
No power comes ON.	<ul style="list-style-type: none"> •Bad connection to the power supply. 	<ul style="list-style-type: none"> •Check the connection to the transceiver. 	p. 42
No sound comes from the speaker.	<ul style="list-style-type: none"> •Squelch level is too high. •Volume level is too low. •Speaker has been exposed to water. •Internal speaker is turned OFF. 	<ul style="list-style-type: none"> •Set squelch to the threshold point. •Set [VOL] to a suitable level. •Drain water from the speaker. •Turn the internal speaker ON in Set mode 	<p>p. 7</p> <p>p. 7</p> <p>—</p> <p>p. 39</p>
Sensitivity is low.	<ul style="list-style-type: none"> •The attenuator is activated. 	<ul style="list-style-type: none"> •Push [LO/DX] to turn the function OFF. 	p. 7
Transmitting is impossible, or high power cannot be selected.	<ul style="list-style-type: none"> •Some channels are for low power or receive only. •The output power is set to low. 	<ul style="list-style-type: none"> •Change channels. •Push [HI/LO] to select high power. 	<p>pgs. 5, 48</p> <p>p. 7</p>
Scan does not start.	<ul style="list-style-type: none"> •‘TAG’ channel is not programmed. 	<ul style="list-style-type: none"> •Set the desired channels as ‘TAG’ channels. 	p. 12
No beep sounds.	<ul style="list-style-type: none"> •Beep tone is turned OFF. •The squelch is open. 	<ul style="list-style-type: none"> •Turn the beep tone ON in Set mode •Set squelch to the threshold point. 	<p>p. 39</p> <p>p. 7</p>
Receive signal cannot be understood.	<ul style="list-style-type: none"> •Optional voice scrambler is turned OFF. •Scramble code is not set correctly. 	<ul style="list-style-type: none"> •Turn the optional voice scrambler ON. •Reset the scramble code. 	<p>p. 9</p> <p>p. 40</p>
Distress call cannot be transmitted.	<ul style="list-style-type: none"> •MMSI (DSC self ID) code is not programmed. 	<ul style="list-style-type: none"> •Program the MMSI (DSC self ID) code. 	p. 13

10. Channel List

Channel number			Frequency (MHz)	
USA	INT	CAN	Transmit	Receive
	01	01	156.050	160.650
01A			156.050	156.050
	02	02	156.100	160.700
	03	03	156.150	160.750
03A			156.150	156.150
	04		156.200	160.800
		04A	156.200	156.200
	05		156.250	160.850
05A		05A	156.250	156.250
06	06	06	156.300	156.300
	07		156.350	160.950
07A		07A	156.350	156.350
08	08	08	156.400	156.400
09	09	09	156.450	156.450
10	10	10	156.500	156.500
11	11	11	156.550	156.550
12	12	12	156.600	156.600
13 [†]	13	13 [†]	156.650	156.650
14	14	14	156.700	156.700
15 [†]	15 [†]	15 [†]	156.750	156.750
16	16	16	156.800	156.800
17 [†]	17	17 [†]	156.850	156.850
	18		156.900	161.500
18A		18A	156.900	156.900
	19		156.950	161.550

Channel number			Frequency (MHz)	
USA	INT	CAN	Transmit	Receive
19A		19A	156.950	156.950
20	20	20 [†]	157.000	161.600
20A			157.000	157.000
	21	21	157.050	161.650
21A		21A	157.050	157.050
		21b	Rx only	161.650
	22		157.100	161.700
22A		22A	157.100	157.100
	23	23	157.150	161.750
23A			157.150	157.150
24	24	24	157.200	161.800
25	25	25	157.250	161.850
		25b	Rx only	161.850
26	26	26	157.300	161.900
27	27	27	157.350	161.950
28	28	28	157.400	162.000
		28b	Rx only	162.000
	60	60	156.025	160.625
	61		156.075	160.675
61A		61A	156.075	156.075
	62		156.125	160.725
		62A	156.125	156.125
	63		156.175	160.775
63A			156.175	156.175
	64	64	156.225	160.825

Channel number			Frequency (MHz)	
USA	INT	CAN	Transmit	Receive
64A		64A	156.225	156.225
	65		156.275	160.875
65A	65A	65A	156.275	156.275
	66		156.325	160.925
66A	66A	66A [†]	156.325	156.325
67 [†]	67	67	156.375	156.375
68	68	68	156.425	156.425
69	69	69	156.475	156.475
70 [†]	70 [†]	70 [†]	156.525	156.525
71	71	71	156.575	156.575
72	72	72	156.625	156.625
73	73	73	156.675	156.675
74	74	74	156.725	156.725
77 [†]	77	77 [†]	156.875	156.875
	78		156.925	161.525
78A		78A	156.925	156.925
	79		156.975	161.575
79A		79A	156.975	156.975
	80		157.025	161.625
80A		80A	157.025	157.025
	81		157.075	161.675
81A		81A	157.075	157.075
	82		157.125	161.725
82A		82A	157.125	157.125
	83	83	157.175	161.775

Channel number			Frequency (MHz)	
USA	INT	CAN	Transmit	Receive
83A		83A	157.175	157.175
		83b	Rx only	161.775
84	84	84	157.225	161.825
84A			157.225	157.225
85	85	85	157.275	161.875
85A			157.275	157.275
86	86	86	157.325	161.925
86A			157.325	157.325
87	87	87	157.375	161.975
87A			157.375	157.375
88	88	88	157.425	162.025
88A			157.425	157.425
WX channel	Frequency (MHz)			
	Transmit	Receive		
1	RX only		162.550	
2	RX only		162.400	
3	RX only		162.475	
4	RX only		162.425	
5	RX only		162.450	
6	RX only		162.500	
7	RX only		162.525	
8	RX only		161.650	
9	RX only		161.775	
10	RX only		163.275	

[†]Low power only. [‡]DSC operation only.

NOTE: Simplex channels, 3, 21, 23, 61, 64, 81, 82 and 83 **CANNOT** be lawfully used by the general public in U.S.A. waters.

11. Operating Rules

◇ PRIORITIES

- Read all rules and regulations pertaining to priorities and keep an up-to-date copy handy. Safety and distress calls take priority over all others.
- You must monitor Channel 16 when you are not operating on another channel.
- False or fraudulent distress signals are prohibited and punishable by law.

◇ PRIVACY

- Information overheard but not intended for you cannot lawfully be used in any way.
- Indecent or profane language is prohibited.

◇ RADIO LICENSES

(1) SHIP STATION LICENSE

You must have a current radio station license before using the transceiver. It is unlawful to operate a ship station which is not licensed.

Inquire through your dealer or the appropriate government agency for a Ship-Radiotelephone license application. This government-issued license states the call sign which is your craft's identification for radio purposes.

(2) OPERATOR'S LICENSE

A Restricted Radiotelephone Operator Permit is the license most often held by small vessel radio operators when a radio is not required for safety purposes.

The Restricted Radiotelephone Operator Permit must be posted or kept with the operator. Only a licensed radio operator may operate a transceiver.

However, non-licensed individuals may talk over a transceiver if a licensed operator starts, supervises, ends the call and makes the necessary log entries.

Keep a copy of the current government rules and regulations handy.

Radio license for boaters (U.S.A. only)

The Telecommunications Act of 1996 permits recreational boaters to have and use a VHF marine radio, EPIRB, and marine radar without having an FCC ship station license. Boaters traveling on international voyages, having an HF single sideband radiotelephone or marine satellite terminal, or required to carry a marine radio under any other regulation must still carry an FCC ship station license. For further information, see the FCC Ship Radio Stations Fact Sheet.

12. Specifications

■ Specifications

General

- Frequency coverage :
 - Transmit 156.025–157.425 MHz
 - Receive 156.050–163.275 MHz
- Mode : FM (16K0G3E)
DSC (16K0G2B)
- Channel spacing : 25 kHz
- Current drain (at 13.8 V) : TX high 5.5 A max.
Max. audio 1.5 A max.
- Power supply requirement: 13.8 V DC $\pm 15\%$
- Frequency stability : ± 10 ppm
(-20°C to $+60^{\circ}\text{C}$; -4°F to $+140^{\circ}\text{F}$)
- Dimensions : 165(W) \times 110(H) \times 103(D) mm
(Projection not included) 6 $\frac{1}{2}$ (W) \times 4 $\frac{11}{32}$ (H) \times 4 $\frac{1}{16}$ (D) in
- Weight (approx.) : 1130 g; 2 lb 8 oz

Transmitter

- Output power : 25 W / 1 W
- Modulation system : Variable reactance phase modulation
- Max. frequency deviation : ± 5.0 kHz
- Spurious emissions : -70 dBc

Receiver

- Receive system : Double conversion superheterodyne
- Sensitivity (12 dB SINAD) : 0.22 μV (typical)
- Squelch sensitivity : 0.22 μV (typical)
- Intermodulation rejection ratio: More than 75 dB
- Spurious response : More than 75 dB rejection ratio
- Adjacent channel selectivity: More than 75 dB
- Audio output power : 4.5 W (typical) at 10% distortion with a 4 Ω load

All stated specifications are subject to change without notice or obligation.

13.1 Panel Description

The optional FM-3010 remotely controls the FM-3000 and provides an optional Intercom function.

13.1.1 Front and side keys

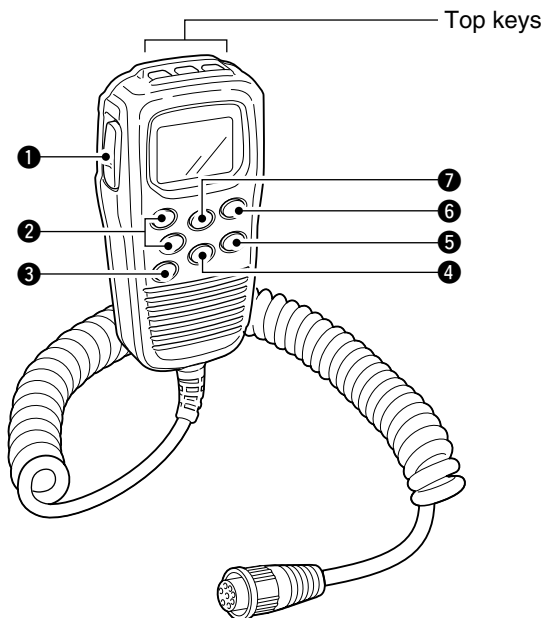

- ❶ **PTT SWITCH [PTT]** (pgs. 7, 56)
Push and hold to transmit; release to receive.
- ❷ **CHANNEL UP/DOWN KEYS [▲]/[▼]**
 - ➔ Push either key to change the operating channel, Set mode settings, etc. (pgs. 7, 56)
 - ➔ Push either key to adjust audio level or noise squelch level after [VOL] or [SQL] is pushed, respectively. (pgs. 7, 56)
 - ➔ Push either key to adjust the brightness of the LCD and key backlight after [VOL] is pushed for 1 sec. (p. 57)
 - ➔ In Set mode, changes setting of the selected item. (pgs. 37, 61)
 - ➔ Checks tag channels or changes scanning direction during scan. (pgs. 12, 60)
- ❸ **CHANNEL 16/CALL CHANNEL KEY [16] [9]**
 - ➔ Selects Channel 16 when pushed. (pgs. 5, 55)
 - ➔ Selects call channel when pushed for 1 sec. (pgs. 5, 55)
•“CALL” appears when call channel is selected.
 - ➔ Push for 3 sec. to enter call channel programming condition when call channel is selected. (pgs. 8, 58)
 - ➔ While pushing [H/L], enters channel comments programming condition. (pgs. 8, 62)
 - ➔ Enters Set mode when pushed while turning power ON. (pgs. 37, 61)

13. FM-3010 CONTROLLABLE MIC

4 CHANNEL/DUALWATCH/TRI-WATCH KEY

[CH/WX] (**DW** **U/C**)

- ➔ Selects and toggles the regular channels and weather channel when pushed momentarily. (pgs. 5, 6, 55)
- ➔ While pushing **[H/L]**, selects one of 3 regular channels in sequence when pushed. (pgs. 6, 55)
 - International, U.S.A. and Canadian channels are available for regular channels.
- ➔ Starts Dualwatch or Tri-watch when pushed for 1 sec. (pgs. 10, 59)
- ➔ Stops Dualwatch or Tri-watch when either is activated.

5 ATTENUATOR/INTERCOM/SCRAMBLER KEY

[LO/DX] (**LC** **SCR**)

- ➔ Toggles the Attenuator function ON or OFF when pushed momentarily. (pgs. 7, 56)
 - "LOCAL" appears when the Attenuator is in use.
- ➔ Activates the Intercom function when pushed for 1 sec. (pgs. 35, 62)
- ➔ Calls the FM-3000 when pushed and held while in Intercom mode. (pgs. 35, 62)
- ➔ While pushing **[H/L]**, activates an optional Voice scrambler function. (pgs. 9, 59)
 - The optional Voice scrambler function cannot be used on Channel 16 and 70.

6 SQUELCH/MONITOR/LOCK KEY **[SQL]** (**MONI** **L**)

- ➔ **[▲]/[▼]** sets the squelch threshold level after pushing **[SQL]**. (p. 56)
- ➔ Push **[SQL]** (**MONI** **L**) for 1 sec. to turn the monitor function ON. (p. 58)
- ➔ While pushing **[H/L]**, push **[SQL]** (**MONI** **L**) to toggle the (microphone) Key lock function ON or OFF. (p. 57)
 - "**L**" appears while Key lock function is in use.
 - **[PWR]**, **[PTT]**, **[VOL]**, **[SQL]** and **[H/L]** still function when the (microphone) Key lock function is turned ON.
- ➔ Advance the cursor while in channel comment programming condition. (pgs. 8, 62)

7 VOLUME/DIMMER KEY **[VOL]** (**DIM**)

- ➔ **[▲]/[▼]** adjusts the audio level after pushing **[VOL]** (p. 56)
- ➔ Push **[VOL]** (**DIM**) for 1 sec. to adjust the brightness of the LCD and key backlight. (p. 57)
- ➔ Move the cursor backward while in channel comment programming condition. (pgs. 8, 62)

13. FM-3010 CONTROLLABLE MIC

13.1.2 Top keys

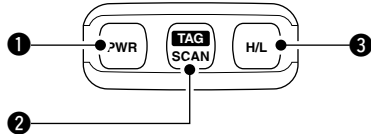

- 1 POWER KEY [PWR]** (pgs. 7, 56)
 Push for 2 sec. to turn the FM-3010 power ON or OFF when the FM-3000 power is turned ON.
- 2 SCAN KEY [SCAN] (TAG)** (pgs. 12, 60)
 - Starts and stops Normal or Priority scan when tag channels are programmed.
 - Push [SCAN] (TAG) for 1 sec. to set the displayed channel as a tag (scanned) channel.
 - While pushing [H/L], push for 3 sec. to clear or set all tag channels.
- 3 TRANSMIT POWER KEY [H/L]**
 - Toggles high or low power when pushed. (pgs. 7, 56)
 - Some Channels are set to low power only.
 - While pushing this key, other keys perform secondary functions.
 - Toggles the All key lock function ON or OFF when pushed while turning power ON. (p. 57)
 - “**L**” blinks while the All key lock function is in use.
 - Only [PWR] and [PTT] function when the All key lock function is in use.

13.2 Function Display

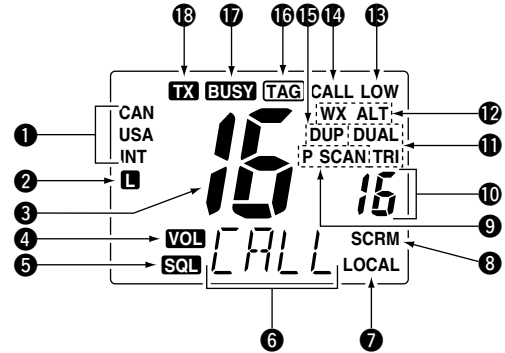

- 1 CHANNEL GROUP INDICATOR** (pgs. 6, 55)
 Indicates whether an International (INT), U.S.A. (USA) or Canadian (CAN) channel is selected.
- 2 KEY LOCK INDICATOR** (p. 57)
 - Appears while the Key lock function is in use.
 - Blinks while the All key lock function is in use.

13. FM-3010 CONTROLLABLE MIC

③ CHANNEL NUMBER READOUT

- ➔ Indicates the selected operating channel number. “A” appears when a simplex channel is selected. “b” appears when a receive only channel for a Canadian channel group is selected. (pgs. 5, 55)
- ➔ In Set mode, indicates the selected condition. (pgs. 37, 61)

④ VOLUME INDICATOR (p. 56)

Appears while audio output level is adjusted.

⑤ SQUELCH INDICATOR (p. 56)

Appears while noise squelch level is adjusted.

⑥ CHANNEL COMMENT INDICATOR

- ➔ Channel comment appears (and scrolls) if programmed. (pgs. 8, 623)
- ➔ In Set mode, indicates or scrolls the selected Set mode item. (pgs. 37, 61)

⑦ ATTENUATOR INDICATOR (pgs. 7, 56)

Appears when the RF Attenuator is in use.

⑧ SCRAMBLER INDICATOR (pgs. 9, 59)

Appears when an optional Voice scrambler is activated.

⑨ SCAN INDICATOR (pgs. 12, 60)

- ➔ “SCAN” appears during Normal scan.
- ➔ “P SCAN” appears during Priority scan.

⑩ PRIORITY CHANNEL INDICATOR

- ➔ Indicates a priority channel during Priority scan or Dual/Tri-watch. (pgs. 10, 12, 59, 60)
- ➔ “IC” appears during Intercom mode. (pgs. 35, 62)

⑪ DUAL/TRI WATCH INDICATOR (pgs. 10, 59)

“DUAL” appears during Dualwatch; “TRI” during Tri-watch.

⑫ WEATHER CHANNEL INDICATOR (pgs. 6, 55)

- ➔ “WX” appears when a weather channel is selected.
- ➔ “WX ALT” appears when the Weather alert function is in use; blinks when an alert tone is received.

⑬ LOW POWER INDICATOR (pgs. 7, 56)

Appears when low power is selected.

⑭ CALL CHANNEL INDICATOR (pgs. 5, 55)

Appears when call channel is selected.

⑮ DUPLEX INDICATOR (pgs. 6, 55)

Appears when a duplex channel is selected.

⑯ TAG CHANNEL INDICATOR (pgs. 12, 60)

Appears when a tag channel is selected.

⑰ BUSY INDICATOR (pgs. 7, 56, 58)

Appears when receiving a signal or when the squelch opens.

⑱ TRANSMIT INDICATOR (pgs. 7, 56)

Appears while transmitting.

13. FM-3010 CONTROLLABLE MIC

13.3 Channel Selection

13.3.1 Channel 16

- ① Push [16] to select Channel 16.
- ② Push [CH/WX] to return to the condition before selecting Channel 16, or push [▲] or [▼] to select an operating channel.



Push [16]

13.3.2 Call channel

- ① Push [16] for 1 sec. to select call channel.
- ② Push [CH/WX] to return to the condition before selecting call channel, or push [▲] or [▼] to select an operating channel.

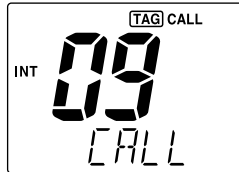

Push [16] for 1 sec.

13.3.3 Weather channels

- ① Push [CH/WX] once or twice to select the weather channel group.
- ② Push [▲] or [▼] to select a weather channel.
- ③ Push [CH/WX] to return xto the condition before selecting the weather channel group.

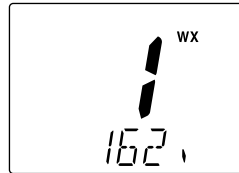

Push [CH/WX]

13.3.4 U.S.A., International and Canadian channels

- ① Push [CH/WX] () to select a regular channel.
 - Push [CH/WX] () again, if a weather channel appears.
- ② While pushing [H/L], push [CH/WX] () to select a channel group.
 - U.S.A., International and Canadian channels can be selected in sequence.

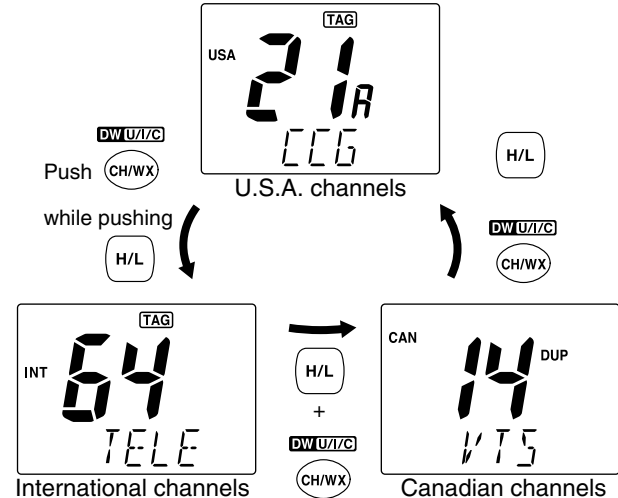

13. FM-3010 CONTROLLABLE MIC

13.4 Receiving and Transmitting

- ① Push **[PWR]** to turn power ON.
- ② Push **[VOL]**, then **[▲]/[▼]** to adjust audio output level.
 - Push **[SQL]**, then push **[▲]/[▼]** to mute any audio noise, if necessary.
- ③ Push **[▲]/[▼]** to select the desired channel.
 - When receiving a signal, “**BUSY**” appears and audio is emitted from the speaker.
 - Further adjustment of the audio level may be necessary at this point.
 - Use the optional Voice scrambler function for privacy. (pgs. 9, 59)
- ④ Push **[H/L]** to select the output power, if necessary.
 - “**LOW**” appears when low power is selected.
 - Choose low power to reduce an intermodulation for other stations, choose high power for longer distance communications.
 - Some channels are for selecting low power only.
- ⑤ Push and hold **[PTT]** to transmit, then speak into the microphone.
 - “**TX**” appears.
 - Channel 70 cannot be used for transmission.

Note: Simplex channels, 3, 21, 23, 61, 64, 81, 82 and 83 **CANNOT** be lawfully used by the general public in U.S.A. waters.

- ⑥ Release **[PTT]** to receive.

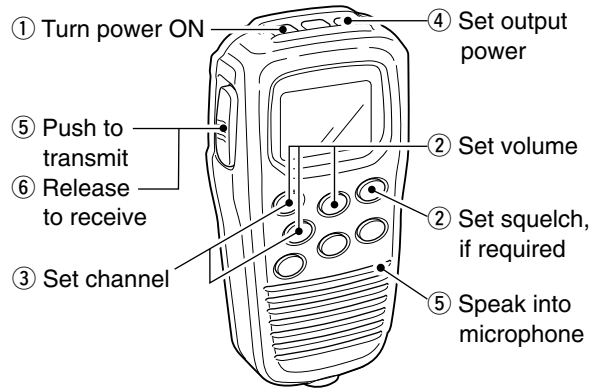

IMPORTANT: To maximize the readability of your transmitted signal (voice), pause a few sec. after pushing **[PTT]**, hold the microphone 2 to 4 inches (5 to 10 cm) from your mouth and speak at a normal voice level.

13. FM-3010 CONTROLLABLE MIC

13.5 Lock Functions

The Lock function electronically locks keys to prevent accidental changes and function access from the microphone.

- All keys and controllers on the transceiver are functional.

13.5.1 Activating the Lock function

➔ While pushing [H/L], push [SQL] (MONI L) to turn the Lock function ON or OFF.

- “” appears.
- Only [PWR], [PTT], [H/L], [SQL] (MONI L), [VOL]+[▲]/[▼] and [SQL]+[▲]/[▼] are functional.

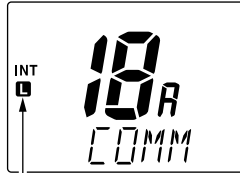

Appears when the lock function is in use.

13.5.2 Activating the All key lock function

➔ While pushing [H/L], turn the power ON by pushing [PWR] to turn the All key lock function ON or OFF.

- “” blinks.
- Only [PWR] and [PTT] are functional.



Blinks when the all lock function is in use.

13.6 Display Backlighting

The function display and keys can be backlit for better visibility under low light conditions. The backlighting condition can also be adjusted independently from the transceiver.

① Push [VOL] () for 1 sec. to enter Backlight adjusting mode.

- “DIM” with the number of the backlight level appears in the channel comment indicator.

② Push [▲]/[▼] to adjust the backlight level.

- The backlight level is adjustable between 0 (light OFF) and 7 (brightest).

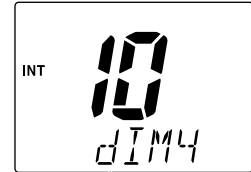

Appears while in the Backlight adjustment mode.

For your reference:

Pushing [▲]/[▼], while [H/L] is pushed, also adjusts backlight level.

- No backlight level indication is available.
-

13. FM-3010 CONTROLLABLE MIC

13.7 Monitor Function

The monitor function releases the noise squelch mute of the microphone only. (An independent noise squelch system is employed.)

➔ Push **[SQL] (MONI L)** for 1 sec. to activate the Monitor function.

- “**BUSY**” blinks and audio is emitted.
- Any key cancels the Monitor function.

Blinks when the Monitor function is in use.

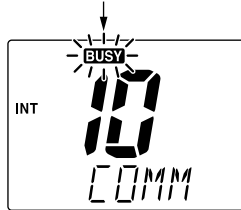

13.8 RF Attenuator Function

➔ Push **[LO/DX]** to turn the RF attenuator function ON and OFF.



Appears when the RF attenuator function is in use.

13.9 Call Channel Programming

① Push **[CH/WX] (DW U/C)** several times while pushing **[H/L]** to select the desired channel group (USA, INT, CAN) to be programmed.



② Push **[16] (9)** for 1 sec. to select call channel of the selected channel group.
• “CALL” and call channel number appear.



③ Push **[16] (9)** again for 3 sec. (until a long beep changes to 2 short beeps) to enter call channel programming condition.
• The channel number and channel group to be programmed blinks.

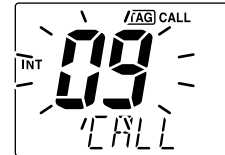

④ Push **[▲]/[▼]** to select the desired channel.

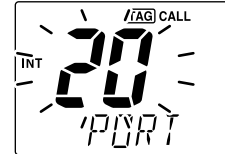

⑤ Push **[16] (9)** to program the displayed channel as call channel.
• The channel number and channel group stop flashing.



13. FM-3010 CONTROLLABLE MIC

13.10 Optional Voice Scrambler Operation

13.10.1 Activating the Scrambler

- ① Select an operating channel, except for Channel 16, Channel 70 or weather channels.
- ② While pushing [H/L], push [LO/DX]([IC] [SCR]) to turn the Voice scrambler function ON.
 - “SCRM” appears.
- ③ To turn the Scrambler function OFF, repeat step ②.
 - “SCRM” disappears.



Appears when the Voice scrambler function is in use

13.10.2 Programming scramble codes

There are 32 codes (01 to 32) available with the FM-3030 for programming. In order to understand one another, all transceivers in your group must have the same scrambler code. The scrambler code is programmed in Set mode. See pgs. 9, 40 for details.

13.11 Dualwatch/Tri-watch Operation

- ① Push [▲]/[▼] to select the desired channel.
 - Push [CH/WX]([DW] [U/C]) several times while pushing [H/L] to select the channel group (USA, INT, CAN), if desired.
- ② Push [CH/WX]([DW] [U/C]) for 1 sec. to start Dualwatch or Tri-watch.
 - “DUAL” appears during Dualwatch; “TRI” appears during Tri-watch.
 - A beep tone sounds when a signal is received on Channel 16.
 - Tri-watch becomes Dualwatch when receiving a signal on call channel.
 - Dualwatch or Tri-watch can be selected in the transceiver’s Set mode.
- ③ To cancel Dualwatch/Tri-watch, push [CH/WX]([DW] [U/C]) again.



Appears when the Dual or Tri-watch function is in use.

13. FM-3010 CONTROLLABLE MIC

13.12 Starting a Scan

- ① While pushing [H/L], push [CH/WX] (**DW** **U/M/C**) several times to select the channel group (USA, INT, CAN), if desired.
 - When the Weather alert function is in use, select the desired weather channel with [CH/WX] and [▲]/[▼].
- ② Push [SCAN] to start Priority or Normal scan.
 - “SCAN” appears during Normal scan.
 - The priority channel readout indicates “16”, and “P” and “SCAN” indicators appear during Priority scan.
 - When a signal is received, scan pauses until the signal disappears or resumes after pausing 5 sec. according to the Set mode setting (Channel 16 is still monitored during Priority scan).
 - Push [▲]/[▼] to check the scanning tag channels, to change the scanning direction or resume the scan manually.
- ③ To stop the scan, push [SCAN] (**TAG**).
 - “SCAN” disappears.
 - Pushing [PTT], [16] (**9**) or [CH/WX] also stops the scan.

13.13 Setting Tag Channels

- ① While pushing [H/L], push [CH/WX] (**DW** **U/M/C**) several times to select the channel group (USA, INT, CAN), if desired.
- ② Push [▲]/[▼] to select the desired channel to set as a tag channel.
- ③ Push [SCAN] (**TAG**) for 1 sec. to set the displayed channel as a tag channel.
 - “TAG” appears.
- ④ To cancel the tag channel setting, push [SCAN] (**TAG**) for 1 sec.
 - “TAG” disappears.

Convenient: Clearing (setting) all tagged channels

- While pushing [H/L], push [SCAN] (**TAG**) for 3 sec. (until a long beep changes to 2 short beeps) to clear all tag channels setting in the channel group.
 - After cleared all tag channels, same way to set all tag channels.
-

13. FM-3010 CONTROLLABLE MIC

13.14 Set Mode Programming

Set mode is used to change the condition of the transceiver's functions and the microphone's own functions:

Transceiver's functions—

scan mode (Normal or Priority), scan resume timer, weather alert, Dualwatch/Tri-watch, DSC watch, transceiver's beep tone, internal speaker (transceiver), LCD contrast (transceiver), RF attenuation level, scrambler code and automatic acknowledgement.

Microphone's own functions—

beep tone function (microphone) and LCD contrast (microphone).

In this section, instructions are for the microphone's own functions only. Refer to pgs. 37–40 for the setting of the other functions. (Some functions cannot be selected from the FM-3010.)

Entering Set mode

- ① Turn power OFF.
- ② While pushing **[16] (S)**, turn power ON.
 - After a beep emission, a Set mode item (in the channel comment indicator and the condition in the channel number readout) is displayed.
- ③ Push **[16] (S)** to select the desired item, if necessary.
- ④ Push **[▲]/[▼]** to select the desired condition of the item.
- ⑤ Turn power OFF, then ON to exit Set mode.

•Beep tone “BEEP”

➔ Push **[▲]** to turn ON, **[▼]** to turn OFF the beep output.

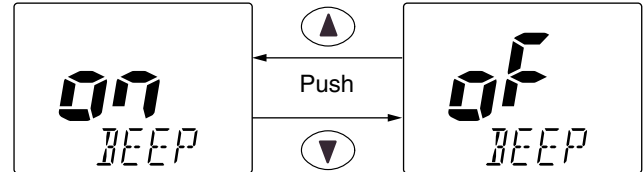

•LCD contrast “LCD CONTRAST”

➔ Push **[▲]/[▼]** to adjust to a suitable LCD contrast.

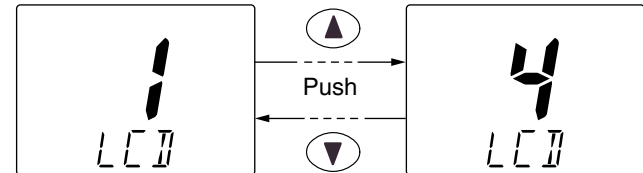

13. FM-3010 CONTROLLABLE MIC

13.15 Intercom Operation

- ① Push **[LO/DX]** (**[IC]** **[SCR]**) for 1 sec. to activate the Intercom function.
 - “IC” appears in the priority channel readout.
 - The channel comment disappears.
- ② Push **[PTT]** to talk.
 - “*TALK*” appears in the channel comment indicator.
- ③ Release **[PTT]** to listen.
 - “*LISTN*” appears in the channel comment indicator when the transceiver is in talking mode.
- ④ Push **[LO/DX]** (**[IC]** **[SCR]**) to cancel the Intercom function.
 - Pushing **[16]** also cancels the Intercom function.



Appears when the intercom function is in use.

For your reference:

In case the Intercom mode is selected with the transceiver while the microphone power is OFF, the microphone power is automatically turned ON and the Intercom mode is selected.

◆ Intercom beep function

- ➔ Push **[LO/DX]** (**[IC]** **[SCR]**) for more than 1 sec.
 - Emits the Intercom beep while holding.

13.16 Channel Comments

- ① Push **[▲]/[▼]** to select a channel to program a channel comment.
 - Push **[CH/WX]** (**[DW]** **[UW/C]**) several times while pushing **[H/L]** to select the channel group (USA, INT, CAN), if desired.
- ② While pushing **[H/L]**, push **[16]** (**[9]**).
 - The 1st character of the currently programmed comment blinks.
- ③ Push **[▲]/[▼]** to select a character.
- ④ Push **[SQL]** to move to forward; then push **[▲]/[▼]** to select a character.
 - Push **[VOL]** to move to backward.
- ⑤ Continue until the desired characters have been selected, then push **[16]** (**[9]**) to return to normal operation.

• Available characters

(space)	! (!)	" (")	# (#)	\$ (\$)	% (%)	& (&)	' (')	((() ()
* (*)	+ (+)	, (,)	-- (-)	, (.)	/ (/)	0 (0)	1 (1)	2 (2)	3 (3)
4 (4)	5 (5)	6 (6)	7 (7)	8 (8)	9 (9)	A (A)	B (B)	C (C)	D (D)
E (E)	F (F)	G (G)	H (H)	I (I)	J (J)	K (K)	L (L)	M (M)	N (N)
O (O)	P (P)	Q (Q)	R (R)	S (S)	T (T)	U (U)	V (V)	W (W)	X (X)
Y (Y)	Z (Z)	a (a)	b (b)	c (c)	d (d)	e (e)	f (f)	g (g)	h (h)
i (i)	j (j)	k (k)	l (l)	m (m)	n (n)	o (o)	p (p)	q (q)	r (r)
s (s)	t (t)	u (u)	v (v)	w (w)	x (x)	y (y)	z (z)		

13. FM-3010 CONTROLLABLE MIC

13.17 FM-3010 supplied accessories

Accessories included with the FM-3010:	Qty.
① Connection cable (FM-3011: 6 m; 20 ft)	1
② Mounting base	1
③ Microphone hanger	1
④ Screws (M3 × 16; tapping)	5

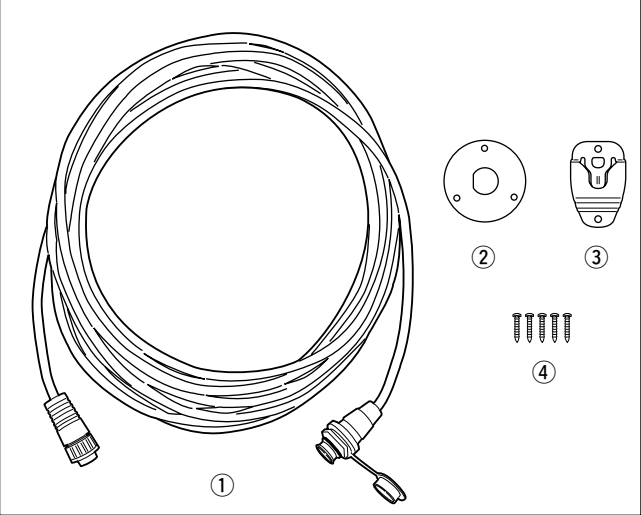

13. FM-3010 CONTROLLABLE MIC

13.18 Installation

The optional FM-3010 can be connected to the transceiver directly, as well as via the supplied connection cable for longer distance remote operation. The connector of the connection cable can be installed into a cabinet, wall, etc., as a built-in plug.

For longer distance remote operation, the optional extension cable, FM-3020 (6 m; 20 ft/connecting between transceiver and the connection cable), is available, and up to 2 FM-3020 can be added.

- ① Insert the supplied cable into the external microphone jack and tighten the cable nut as shown below.

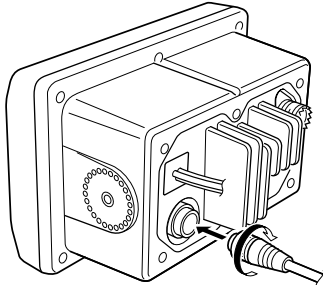

- ② To use the supplied cable as a wall socket, follow the below steps.
- ③ Using the mounting base, carefully mark off the 2 spots where the cable and screws will be fastened.
- ④ Drill holes at these marks.
- ⑤ Install the mounting base using the supplied screws as shown below.

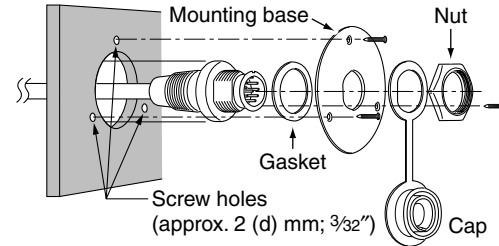

- ⑥ The completed installation should look like this.

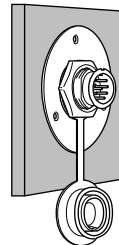

13. FM-3010 CONTROLLABLE MIC

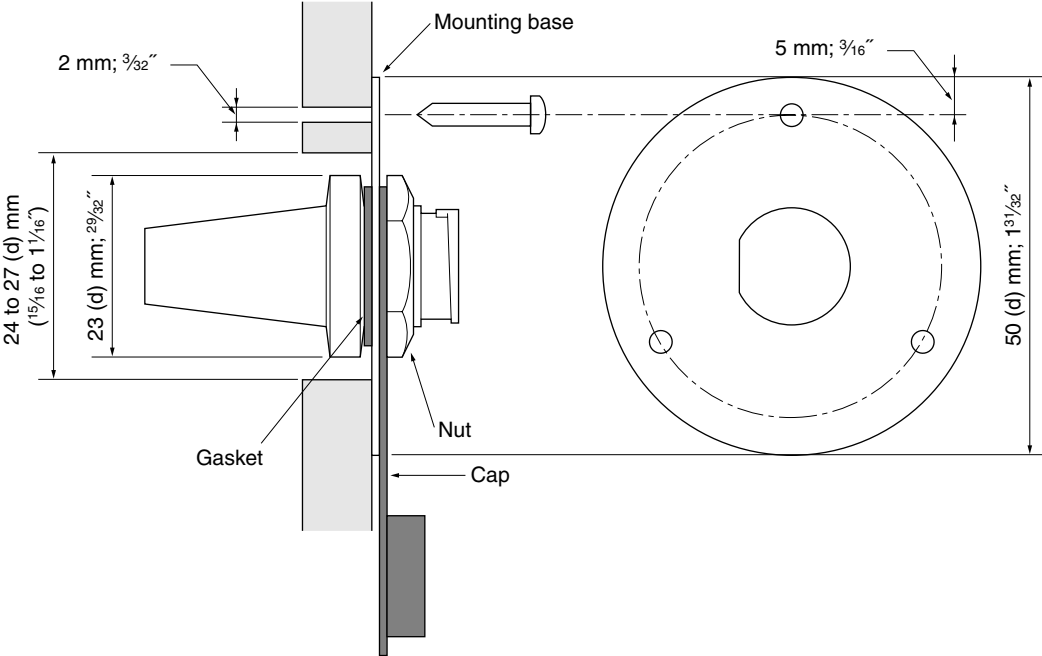

TEMPLATE

