



INSTRUCTION MANUAL

VHF/UHF DUAL BAND FM TRANSCEIVER

IC-E7

Icom Inc.



FOREWORD

Thank you for purchasing this Icom product. The IC-E7 VHF/UHF DUAL BAND FM TRANSCEIVER is designed and built with Icom's superior technology and craftsmanship. With proper care, this product should provide you with years of trouble-free operation.

We want to take a couple of moments of your time to thank you for making your IC-E7 your radio of choice, and hope you agree with Icom's philosophy of "technology first." Many hours of research and development went into the design of your IC-E7.

◆ FEATURES

- *Covers the 0.495–999.990 MHz* frequency range*
*Some frequency bands are disabled according to version
- *CTCSS and DTCS encoder/decoder standard*
- *1250 memory channels* with 18 banks available*
*200 auto write and 50 scan edge channels are included.
- *1800 mAh large capacity Li-Ion battery standard*

IMPORTANT

READ ALL INSTRUCTIONS carefully and completely before using the transceiver.

SAVE THIS INSTRUCTION MANUAL— This instruction manual contains important operating instructions for the IC-E7.

EXPLICIT DEFINITIONS

WORD	DEFINITION
⚠ WARNING!	Personal injury, fire hazard or electric shock may occur.
CAUTION	Equipment damage may occur.
NOTE	Recommended for optimum use. No risk of personal injury, fire or electric shock.

Icom, Icom Inc. and the ICOM logo are registered trademarks of Icom Incorporated (Japan) in the United States, the United Kingdom, Germany, France, Spain, Russia and/or other countries.

PRECAUTION

⚠ WARNING RF EXPOSURE! This device emits Radio Frequency (RF) energy. Caution should be observed when operating this device. If you have any questions regarding RF exposure and safety standards please refer to the Federal Communications Commission Office of Engineering and Technology's report on Evaluating Compliance with FCC Guidelines for Human Radio Frequency Electromagnetic Fields (OET Bulletin 65)

⚠ WARNING! NEVER hold the transceiver so that the antenna is very close to, or touching exposed parts of the body, especially the face or eyes, while transmitting. The transceiver will perform best if the microphone is 5 to 10 cm (2 to 4 inches) away from the lips and the transceiver is vertical.

⚠ WARNING! NEVER operate the transceiver with a earphone, headphones or other audio accessories at high volume levels. Hearing experts advise against continuous high volume operation. If you experience a ringing in your ears, reduce the volume level or discontinue use.

⚠ WARNING! NEVER operate the transceiver while driving a vehicle. Safe driving requires your full attention—anything less may result in an accident.

NEVER expose the transceiver to rain, snow or any liquids. The transceiver may be damaged.

NEVER operate or touch the transceiver with wet hands. This may result in an electric shock or damage the transceiver.

DO NOT push the PTT when not actually desiring to transmit.

AVOID using or placing the transceiver in direct sunlight or in areas with temperatures below -10°C ($+14^{\circ}\text{F}$) or above $+60^{\circ}\text{C}$ ($+140^{\circ}\text{F}$).

Place the unit in a secure place to avoid inadvertent use by children.

AVOID the use of chemical agents such as benzine or alcohol when cleaning, as they can damage the transceiver's surfaces.

SUPPLIED ACCESSORIES

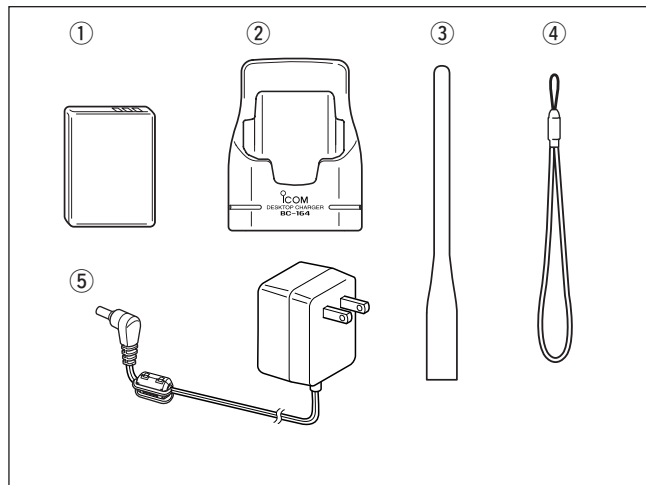

- ① Battery pack (BP-243) 1
- ② Battery charger (BC-164) 1
- ③ Antenna 1
- ④ Handstrap 1
- ⑤ AC adapter* (BC-145LE/LUK) 1

(The shape of the BC-145LE and BC-145LUK are different.)

*Depending on versions. Not supplied with some versions.

TABLE OF CONTENTS

FOREWORD	i
IMPORTANT	i
EXPLICIT DEFINITIONS	i
PRECAUTION	ii
SUPPLIED ACCESSORIES	iii
TABLE OF CONTENTS	iii
QUICK REFERENCE GUIDE	I-VIII
■ Preparation	I
■ Your first contact.....	III
■ Repeater operation	V
■ Memory programming.....	VI
■ Programmed scan operation.....	VII
1 PANEL DESCRIPTION	1-4
■ Front, top and side panels	1
■ Function display	3
2 BATTERY CHARGING	5-8
■ Caution	5
■ Battery installation	7
■ Battery charging	8
3 FREQUENCY AND CHANNEL SETTING	9-12
■ VFO and memory channels.....	9
■ Operating band selection	9
■ Setting a frequency.....	11
■ Setting a tuning step.....	11
■ Selecting a memory channel.....	12
■ Selecting a call channel.....	12
4 BASIC OPERATION	13-18
■ Receiving.....	13
■ Setting audio volume.....	13
■ Squelch level setting	14
■ Operating mode selection	14
■ Monitor function.....	15
■ Attenuator function	15

■ Transmitting.....	16	■ Priority watch operation.....	43
■ Transmit power selection	16	9 TONE SQUELCH AND POCKET BEEP	45–48
■ Dial select step	17	■ Tone/DTCS squelch operation	45
■ Lock function	18	■ Tone squelch frequency/DTCS code setting	46
■ [DIAL] function assignment	18	■ DTCS polarity setting	47
5 REPEATER OPERATION.....	19–23	■ Tone scan	48
■ General.....	19	10 SET MODE	49–59
■ Offset frequency	20	■ General.....	49
■ Subaudible tones.....	21	■ Set mode items	50
■ 1750 Hz tone	23	11 OTHER FUNCTIONS	60–64
6 MEMORY/CALL CHANNELS	24–33	■ Data cloning	60
■ General description	24	■ Auto power-off function	61
■ Memory channel programming.....	24	■ TV channel operation	62
■ Memory bank setting	25	■ All reset	63
■ Memory bank selection	26	■ Partial reset.....	64
■ Programming memory/bank name.....	27	12 FREQUENCY TABLE	65–72
■ Selecting display type.....	28	■ TV channels	65
■ Copying memory contents.....	29	■ VHF marine channels.....	68
■ Memory clearing.....	30	■ Weather channels	68
■ Transferring memory contents	31	■ Other communications in the USA	69
■ Erasing/transferring bank contents.....	32	■ Other communications—other countries.....	71
■ Call channel programming	33	13 MAINTENANCE	73–74
■ Copying call channel contents.....	33	■ Troubleshooting.....	73
7 SCAN OPERATION	34–41	■ Optional CP-21LR fuse replacement.....	74
■ Scan types.....	34	14 SPECIFICATIONS	75–76
■ Full/band/programmed scan.....	35	■ Transceiver.....	75
■ Scan edges programming	36	■ Battery pack (BP-243).....	76
■ Memory/bank scan	37	■ Battery charger (BC-164).....	76
■ Auto memory write scan.....	38	15 OPTIONS	77–79
■ Skip channel/frequency setting	39	■ Options	77
■ Scan resume condition.....	41	16 POCKET GUIDE	80–81
8 PRIORITY WATCH	42–44	17 CE	82
■ Priority watch types	42		

1
2
3
4
5
6
7
8
9
10
11
12
13
14
15
16
17

QUICK REFERENCE GUIDE

■ Preparation

◇ Battery installation

- ① Remove the battery cover from the transceiver.
- ② Install the BP-243 (Li-Ion battery pack).
 - Be sure to observe the correct polarity.
- ③ Replace the battery cover to the transceiver.

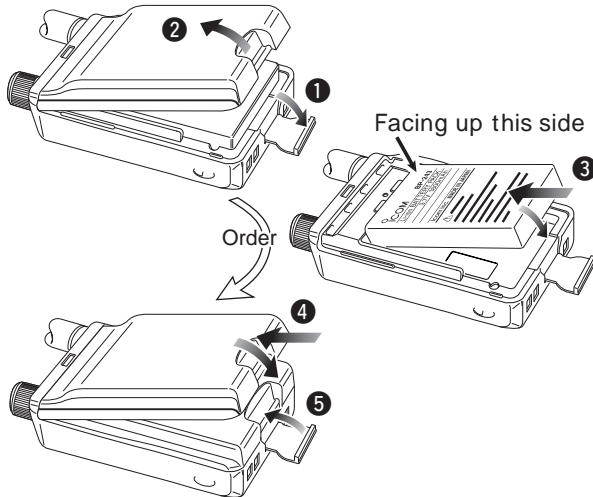

Keep the battery contacts clean. It's a good idea to clean the battery terminals once a week.

◇ Antenna

Insert the supplied antenna into the antenna connector and screw down the antenna as shown at right.

NEVER hold the antenna when carrying the transceiver.

Keep the jack cover attached when jack is not in use to protect the connector from dust and moisture.

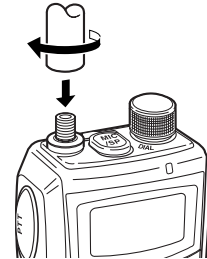

✓ For your information

Third-party antennas may increase transceiver performance. An optional AD-92SMA ANTENNA CONNECTOR ADAPTER is available to connect an antenna with a BNC connector.

◇ Handstrap

Slide the handstrap through the loop on the top of the rear panel as illustrated at right. Facilities carrying.

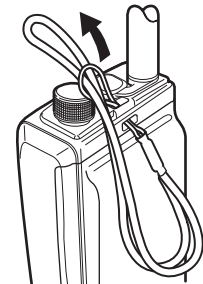

◇ Charging the battery

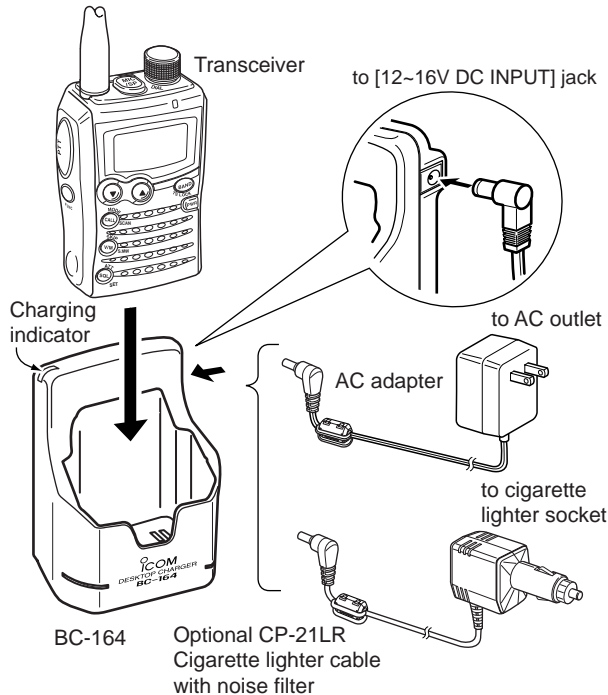



◇ Charging description

- ① Plug the AC adapter into an AC outlet; or the optional CP-21LR into a cigarette lighter socket.
- ② Insert the adapter plug into **[12~16V DC INPUT]** of the BC-164 BATTERY CHARGER.
- ③ Install the BP-243 BATTERY PACK (see left page) to the transceiver.
- ④ Be sure to turn OFF the transceiver, then charge the battery with transceiver.
 - Takes approximately 3 hours for fully charge with the supplied BP-243 battery pack.
 - Charging indicator of BC-164 lights or blinks as follows.

Charging indicator status	Charging status
Lights orange	Charging
Lights green	Charging is completed
Blinking red	Charging error*

* It may be charging outside of the specified temperature range: +5°C to +35°C (+41°F to +95°F). Restore the specified temperature range and reinsert the transceiver.

NOTE: The transceiver has battery indicator to show the following information.

- No indicator appears when the installed battery pack has ample capacity.
- “” (battery indicator) appears when the battery pack is nearing exhaustion.
- “” blinks when the battery pack must be charged.
- “” and “LOW” indicator appear just before the battery pack is completely discharged and display turns OFF.

⚠WARNING!:
NEVER charge any other than the specified battery pack.

QUICK REFERENCE GUIDE

■ Your first contact

Now that you have your IC-E7 ready, you are probably excited to get on the air. We would like to take you through a few basic steps to make your first experience “On The Air” enjoyable.

◇ About default settings

The **[DIAL]** control function can be exchanged with the **[▲]/[▼]** key functions by pushing and holding **[FUNC]** then push **[▲]** or **[▼]**. However, in this QUICK REFERENCE GUIDE, the factory default setting (**[DIAL]** sets operating frequency) is used to simplify the instructions.

◇ Basic operation

1. Turning ON the transceiver

- Push and hold **[PWR]** for 1 sec. to turn the power ON.
 - Opening indication passes through, then frequency indication appears.

▨ The opening indication can be skipped. While pushing and holding **[FUNC]**, push and hold **[PWR]** for 1 sec. to shortcut the opening indication.

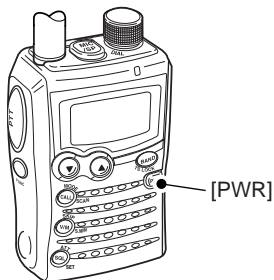

2. Adjusting audio level

- Push **[▲]/[▼]** to set the desired audio level.

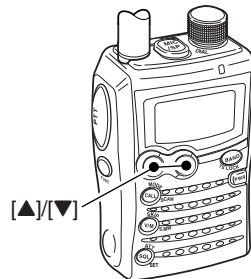

3. Adjusting squelch level

- While pushing and holding **[SQL] (ATT•SET)**, rotate **[DIAL]** to set the squelch level.

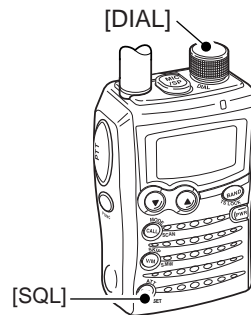

4. Tune the desired frequency

The tuning dial will allow you to dial in the frequency you want to use. Pages 11 and 17 will instruct you on how to set the tuning step size.

- ① Push **[BAND] (TS•LOCK)** several times to select the desired frequency band.
 - While pushing and holding **[BAND] (TS•LOCK)**, rotating **[DIAL]** also selects frequency band.
- ② Rotate **[DIAL]** to set the desired frequency.
 - While pushing and holding **[FUNC]**, rotate **[DIAL]** to select frequency in 1 MHz steps.

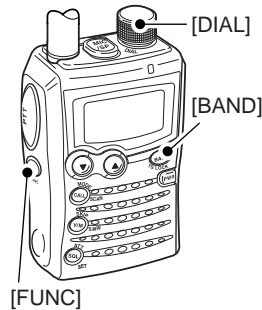

5. Operating mode selection

- While pushing and holding **[FUNC]**, push **[CALL] (MODE•SCAN)** several times to select the desired operating mode.
 - FM, WFM and AM modes are selectable.
 - WFM mode is not selectable below 30 MHz band.

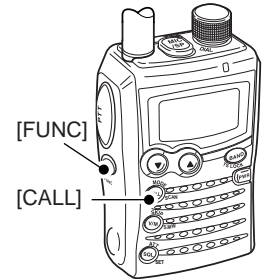

6. Transmit and receive

- Push and hold **[PTT]** to transmit then speak into the microphone; release to receive.
 - Transmission is available on the 144 MHz/430 MHz (FM mode) amateur bands only.



■ Repeater operation

1. Setting duplex

- ① While pushing and holding [FUNC], push and hold [SQL] (ATT•SET) for 1 sec. to enter *set mode*.
- ② Rotate [DIAL] to select "DUP."
- ③ While pushing and holding [FUNC], rotate [DIAL] to select minus duplex or plus duplex.

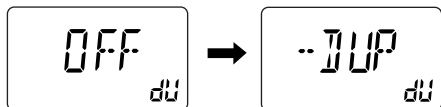
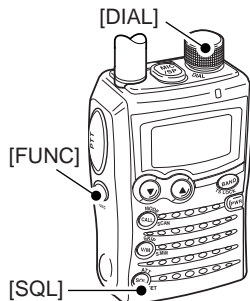

- ④ Push [SQL] (ATT•SET) to exit *set mode*.



2. Repeater tone

- ① While pushing and holding [FUNC], push and hold [SQL] (ATT•SET) for 1 sec. to enter *set mode*.
- ② Rotate [DIAL] to select "T/TSQL."
- ③ While pushing and holding [FUNC], rotate [DIAL] to select the repeater tone activation.

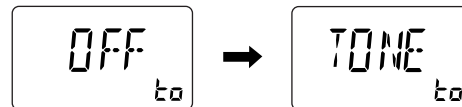
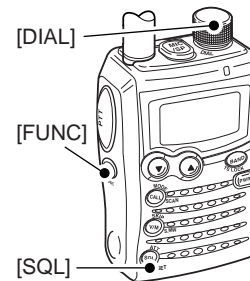

- ④ Push [SQL] (ATT•SET) to exit *set mode*.



/// **NOTE:** The transceiver can transmit a 1750 Hz tone burst.
 /// Push [PTT] briefly, then push and hold [PTT] for 1 to 2
 /// sec. to transmit a 1750 Hz tone burst. (p.23)

■ Memory programming

The IC-E7 has a total of 1250 memory channels (including 200 auto write channels and 50 scan edges) for storing often used operating frequency, mode, etc.

1. Setting frequency

In *VFO mode*, set the desired receive frequency mode.

- When “**MR**” indicator is displayed, push **[V/M] (SKIP•S.MW)** to select the *VFO mode*.

2. Selecting a memory channel

Push **[V/M] (SKIP•S.MW)** for 1 sec. to enter *select memory write mode* (1 short and 1 long beep sound), then rotate **[DIAL]** to select the desired memory channel.

- “**MR**” indicator and memory channel number blink.

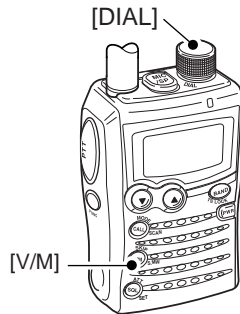
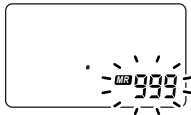

- To cancel and exit *select memory write mode*, push **[V/M] (SKIP•S.MW)** momentarily.

3. Writing a memory channel

Push and hold **[V/M] (SKIP•S.MW)** for 1 sec. until 3 beeps sound.

- Memory channel number automatically increases when continuing to push **[V/M] (SKIP•S.MW)** after programming.

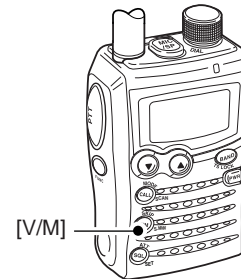

■ Programmed scan operation

50 channels of memories in 25 pairs are used to specify scanning ranges for programmed scan operation. The programmed scan scans between "xxA" and "xxb" (xx=00 to 24) channels. Therefore, before operating the programmed scan, different frequencies must be programmed into the "A" and "b" channels.

◇ Programming scan edges

A start and stop frequency must be programmed into a pair of "xxA" or "xxb" channels.

1. Setting frequency

In *VFO mode*, set the desired operating frequency and mode.

- When "**MR**" indicator is displayed, push **[V/M] (SKIP•S.MW)** to select the *VFO mode*.

2. Selecting a scan edge channel "A"

Push and hold **[V/M] (SKIP•S.MW)** for 1 sec. to enter *select memory write mode* (1 short and 1 long beep sound), then rotate **[DIAL]** to select the desired scan edge channel "A."

- "**MR**" indicator and scan edge channel number blink.



3. Writing a memory channel

Push and hold **[V/M] (SKIP•S.MW)** for 1 sec. until 3 beeps sound.

- Scan edge channel "b" is automatically selected when continuing to push **[V/M] (SKIP•S.MW)** after programming.
- After programming is completed, the display returns to *VFO indication*.

4. Selecting a scan edge channel "b"

Push and hold **[V/M] (SKIP•S.MW)** for 1 sec., then rotate **[DIAL]** to select the desired scan edge channel "b."

- "**MR**" indicator and scan edge channel number blink.
- When the scan edge channel "b" is already selected at step 3, continuing to push **[V/M] (SKIP•S.MW)** after programming, skip this step.



5. Writing a memory channel

Push and hold **[V/M] (SKIP•S.MW)** for 1 sec. until 3 beeps sound.

- The next scan edge channel "A" is automatically selected when continuing to push **[V/M] (SKIP•S.MW)** after programming.
- After programming is completed, the display returns to *VFO indication*.

◆ Starting scan

1. Select *VFO mode*.

Push [V/M] (SKIP•S.MW) to select the *VFO mode* for full, band and programmed scan operation.

- Select *memory mode* by pushing [V/M] (SKIP•S.MW) again for memory or bank scan.

2. Selecting a scanning type

Push and hold [CALL] (MODE•SCAN) for 1 sec., then rotate [DIAL] to select the desired scanning type.

- Available scan types when *VFO mode* is selected; “ALL” for full scan; “BAND” for the selected band; one of “PROGxx” (xx=0 to 24) for programmed scan.
- Available scan types when *memory mode* is selected; “M ALL” for all memory scan “B ALL” for all bank scan, “B LINK” for bank link scan, “BANK” for the selected bank scan.

• Scan type indication examples

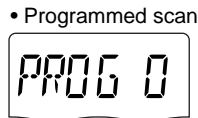
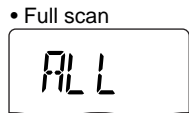
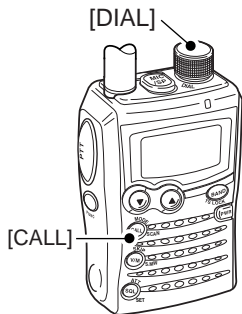

3. Starting scan

Push [CALL] (MODE•SCAN) to start the scan.

- Rotate [DIAL] to change the scanning direction.

- Full/Band scan

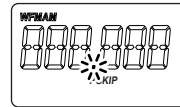

- Programmed scan

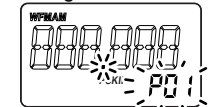

- All memory/All bank/ Bank link scan

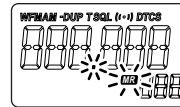

- Bank scan

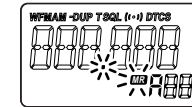

4. Cancelling scan

Push [CALL] (MODE•SCAN) again to stop scan.

✓ For your information

The memory channel number you program the scan edges into correlate “PROGxx” as follows:

00A/00b: Select “PROG 00” to scan between frequencies programmed in 00A and 00b channels.

⋮

24A/24b: Select “PROG 24” to scan between frequencies programmed in 24A and 24b channels.

1

PANEL DESCRIPTION

■ Front, top and side panels

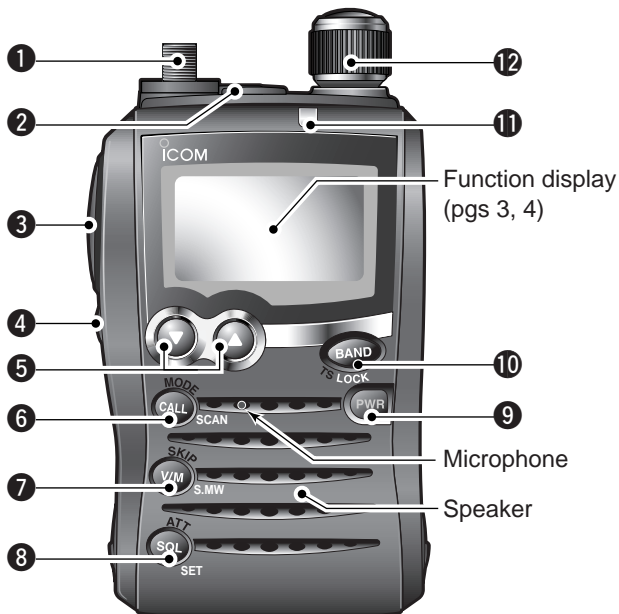

❶ ANTENNA CONNECTOR (p. 1)

Connects to the supplied antenna.

- An optional AD-92SMA adapter (p. 77) is available for connecting an antenna with a BNC connector.

❷ EXTERNAL SPEAKER/MICROPHONE JACK [MIC/SP]

Connects an optional speaker-microphone or headset via an optional †OPC-782 PLUG ADAPTOR CABLE, if desired.

The internal microphone and speaker will not function when the †OPC-782 is connected. (See p. 77 for a list of available options.)

† An optional HM-153P TIE-PIN MICROPHONE can be connected to the IC-E7 directly (without the OPC-782).

❸ PTT SWITCH [PTT] (p. 16)

- Push and hold to transmit, release to receive.
- Push briefly, then push and hold to transmit a 1750 Hz tone burst. (p. 23)
- While pushing and holding [FUNC], push to toggle the transmit output power between High and Low.

❹ FUNCTION KEY [FUNC]

Push and hold this key for access to secondary functions.

❺ UP/DOWN KEYS [▲]/[▼]

- Adjusts audio volume level.* (p. 13)
- While pushing and holding [FUNC], push either key to exchange [DIAL] and [▲]/[▼] function. (p. 18)

*The function of [DIAL] and [▲]/[▼] can be exchanged. See page 18 for details.

6 CALL•MODE•SCAN KEY [CALL] (MODE•SCAN)

- Push momentarily to select the call channel. (p. 12)
- Push and hold for 1 sec. to enter the scan type selection condition, push again to start a scan. (p. 35)
- While pushing and holding [FUNC], push momentarily to select the operating mode. (p. 14)
- While pushing and holding [FUNC], push and hold for 1 sec. to start a tone scan. (p. 48)

7 VFO/MEMORY•MEMORY WRITE KEY [V/M] (SKIP•S.MW)

- Push momentarily to toggle between VFO and *memory mode*. (p. 9)
- Push and hold for 1 sec. to enter *select memory write mode*. (p. 24)
- While pushing and holding [FUNC], push momentarily to select scan skip condition. (p. 40)
- During VFO scan, pushing and holding [FUNC], push and hold for 1 sec. to store into highest blank memory channel as PSKIP channel (p. 40)

8 SQUELCH•ATTENUATOR•SET KEY [SQL] (ATT•SET)

- Push and hold to open the squelch temporarily and monitor the operating frequency. (p. 15)
- While pushing and holding this key, rotate [DIAL]* to adjust the squelch level. (p. 14)
- While pushing and holding [FUNC], push and hold for 1 sec. to enter *set mode*. (p. 49)

9 POWER KEY [PWR]

Push and hold for 1 sec. to turn the transceiver power ON and OFF.

10 BAND•TUNING STEP•LOCK KEY [BAND] (TS•LOCK)

- Push to select the operating frequency band. (p. 9)
- While pushing and holding [FUNC], push momentarily to enter *tuning step set mode*. (p. 11)
- While pushing and holding [FUNC], push and hold for 1 sec. to toggle the lock function ON and OFF. (p. 18)

11 TX RX INDICATOR [TX/RX] (pgs. 13, 16)

Lights green while receiving a signal or when the squelch is open; lights red while transmitting.

12 CONTROL DIAL [DIAL]

- Rotate to select the operating frequency.* (p. 11)
- While scanning, changes the scanning direction.* (p. 35)
- While pushing and holding [SQL] (ATT•SET), sets the squelch level.* (p. 14)
- While pushing and holding [FUNC], changes the operating frequency in 100 kHz, 1 MHz or 10 MHz increments in *VFO mode*.* (p. 11)
- While pushing and holding [FUNC], changes the memory channel in 10 channels steps in *memory mode*.* (p. 12)
- While pushing and holding [BAND] (TS•LOCK), selects the operating band in *VFO mode*.* (p. 9)
- While pushing and holding [BAND] (TS•LOCK), selects the programmed bank or auto memory write channel in *memory mode*.* (p. 9)

1 PANEL DESCRIPTION

■ Function display

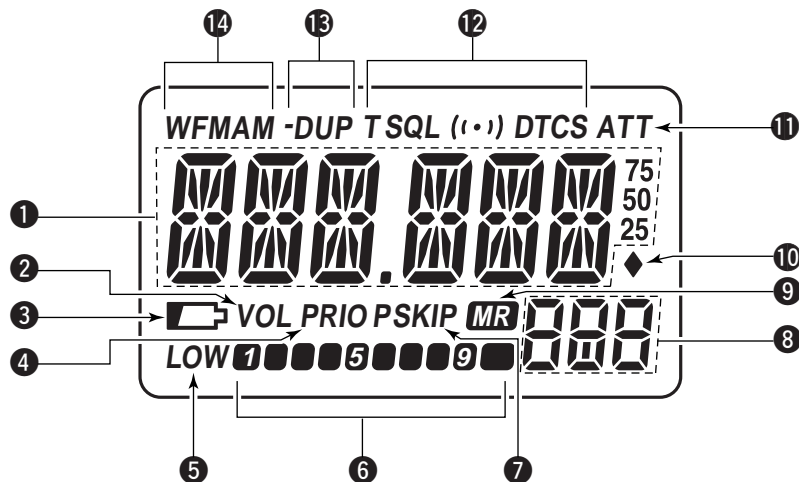

① FREQUENCY READOUT



Displays a variety of information, such as an operating frequency, set mode contents, memory names.

- The smaller “75,” “50” and “25” on the right of the readout indicate 0.75, 0.5 and 0.25 kHz, respectively.
- The decimal point blinks during scan.

② DIAL/VOLUME EXCHANGE INDICATOR (p. 18)

Appears when the function of [DIAL] and [▲]/[▼] are exchanged.

③ BATTERY INDICATOR

- No indicator appears when the installed battery pack has ample capacity.
- “” (battery indicator) appears when the battery pack is nearing exhaustion.
- “” blinks when the battery pack must be charged.
- “” and “LOW” indicator appear just before the battery pack is completely discharged and display turns OFF.

4 PRIORITY WATCH INDICATOR (p. 43)

Appears when priority watch is in use.

5 LOW POWER INDICATOR (p. 16)

- “LOW” appears when the low output power is selected.
- No indicator appears when the high output power is selected.

6 S/RF METER

- Shows the relative signal strength while receiving signals. (p. 13)
- Shows the output power level while transmitting. (p. 16)

7 SKIP INDICATORS (p. 39)

- “SKIP” appears when the selected memory channel is set as a skip channel.
- “PSKIP” appears when the displayed frequency is set as a skip frequency.

8 MEMORY CHANNEL NUMBER INDICATOR

- Shows the selected memory channel number. (pgs. 12, 24)
- “C” appears when the call channel is selected. (p. 12)
- “L” appears when the lock function is active. (p. 18)

9 MEMORY INDICATOR (pgs. 12, 24)

Appears when *memory mode* is selected.

10 AUTO WRITE CHANNEL INDICATOR (p. 38)

Appears when auto write channel is selected.

11 ATTENUATOR INDICATOR (p. 15)

Appears when the RF attenuator is in use.

12 TONE INDICATORS

- “T” appears while the subaudible tone encoder is in use. (p. 21)
- “T SQL” appears while the tone squelch function is in use. (p. 45)
- “DTCS” appears while the DTCS squelch function is in use. (p. 45)
- “(•)” appears with the “T SQL” or “DTCS” indicator while the pocket beep function (with CTCSS or DTCS) is in use. (p. 45)

13 DUPLEX INDICATORS (p. 19)

“DUP” appears when plus duplex, “-DUP” appears when minus duplex (repeater operation) is selected.

14 OPERATING MODE INDICATOR (p. 14)

Shows the selected operating mode.
• FM, WFM and AM are available.

■ Caution

Misuse of LITHIUM-ion batteries may result in the following hazards: smoke, fire, or the battery may rupture. Misuse can also cause damage to the battery or degradation of battery performance.

- **⚠ DANGER!** Use and charge only specified Icom battery packs with Icom radios. Only Icom battery packs are tested and approved for use with Icom radios. Using third-party or counterfeit battery packs may cause smoke, fire, or cause the battery to burst.

◇ Battery caution

- **⚠ DANGER! DO NOT** hammer or otherwise impact the battery. Do not use the battery if it has been severely impacted or dropped, or if the battery has been subjected to heavy pressure. Battery damage may not be visible on the outside of the case. Even if the surface of the battery does not show cracks or any other damage, the cells inside the battery may rupture or catch fire.
 - **⚠ DANGER! NEVER** use or leave battery pack in areas with temperatures above +60°C (+140°F). High temperature buildup in the battery, such as could occur near fires or stoves, inside a sun heated car, or in direct sunlight may cause the battery to rupture or catch fire. Excessive temperatures may also degrade battery performance or shorten battery life.
- **⚠ DANGER! DO NOT** expose the battery to rain, snow, seawater, or any other liquids. Do not charge or use a wet battery. If the battery gets wet, be sure to wipe it dry before using. The battery is not waterproof.
 - **⚠ DANGER! NEVER** incinerate used battery pack since internal battery gas may cause it to rupture, or may cause an explosion.
 - **⚠ DANGER! NEVER** solder the battery terminals. This may cause heat generation, and the battery may rupture, emit smoke or catch fire.
 - **⚠ DANGER!** Use the battery only with the transceiver for which it is specified. Never use a battery with any other equipment, or for any purpose that is not specified in this instruction manual.
 - **⚠ DANGER!** If fluid from inside the battery gets in your eyes, blindness can result. Rinse your eyes with clean water, without rubbing them, and see a doctor immediately.
 - **WARNING!** Immediately stop using the battery if it emits an abnormal odor, heats up, or is discolored or deformed. If any of these conditions occur, contact your Icom dealer or distributor.
 - **WARNING!** Immediately wash, using clean water, any part of the body that comes into contact with fluid from inside the battery.

- **WARNING! NEVER** put the battery in a microwave oven, high-pressure container, or in an induction heating cooker. This could cause a fire, overheating, or cause the battery to rupture.
- **CAUTION!** Always use the battery within the specified temperature range for the transceiver (-10°C to $+60^{\circ}\text{C}$; $+14^{\circ}\text{F}$ to $+140^{\circ}\text{F}$) and the battery itself (-20°C to $+60^{\circ}\text{C}$; -4°F to $+140^{\circ}\text{F}$). Using the battery out of its specified temperature range will reduce the battery's performance and battery life. Please note that the specified temperature range of the battery may exceed that of the transceiver. In such cases, the transceiver may not work properly because it is out of its operating temperature range.
- **CAUTION!** Shorter battery life could occur if the battery is left fully charged, completely discharged, or in an excessive temperature environment (above $+50^{\circ}\text{C}$; $+122^{\circ}\text{F}$) for an extended period of time. If the battery must be left unused for a long time, it must be detached from the radio after discharging. You may use the battery until the battery indicator shows half-capacity, then keep it safely in a cool dry place with the temperature between -20°C to $+20^{\circ}\text{C}$ (-4°F to $+68^{\circ}\text{F}$).

◇ Charging caution

- **⚠ DANGER! NEVER** charge the battery pack in areas with extremely high temperatures, such as near fires or stoves, inside a sun heated car, or in direct sunlight. In such environments, the safety/protection circuit in the battery will activate, causing the battery to stop charging.
- **WARNING! DO NOT** charge or leave the battery in the battery charger beyond the specified time for charging. If the battery is not completely charged by the specified time, stop charging and remove the battery from the battery charger. Continuing to charge the battery beyond the specified time limit may cause a fire, overheating, or the battery may rupture.
- **WARNING! NEVER** insert the transceiver (battery attached to the transceiver) into the charger if it is wet or soiled. This could corrode the battery charger terminals or damage the charger. The charger is not waterproof.
- **CAUTION! DO NOT** charge the battery outside of the specified temperature range: $+5^{\circ}\text{C}$ to $+35^{\circ}\text{C}$ ($+41^{\circ}\text{F}$ to $+95^{\circ}\text{F}$). Icom recommends charging the battery at $+20^{\circ}\text{C}$ ($+68^{\circ}\text{F}$). The battery may heat up or rupture if charged out of the specified temperature range. Additionally, battery performance or battery life may be reduced.

2 BATTERY CHARGING

■ Battery installation

Before installing, or replacing the battery pack, be sure to turn OFF the transceiver. If it's ON, push and hold [PWR] for 1 sec. to turn the power OFF.

- ① Remove the battery cover from the transceiver.

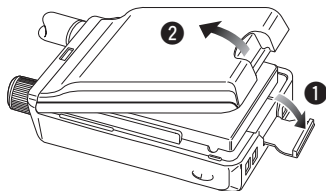

- ② Install the BP-243 (Li-Ion battery pack).
• Be sure to observe the correct polarity.

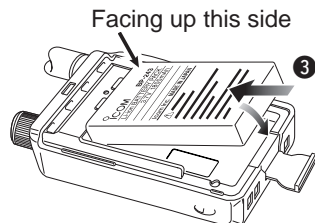

- ③ Replace the battery cover to the transceiver.

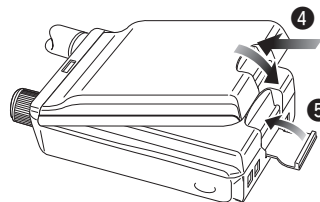

Keep the battery contacts clean to avoid rust or poor contact. It's a good idea to clean the battery terminals once a week.

■ Battery charging

◇ Charging connections

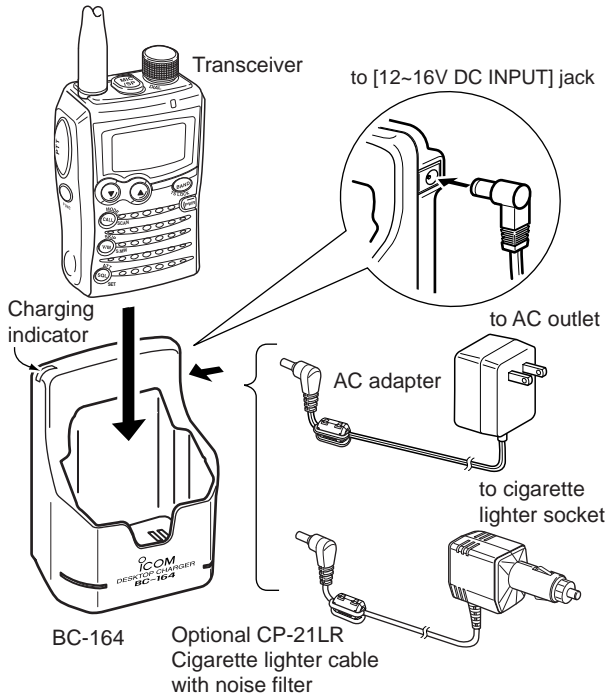

• **Charging periods:** Approx. 3 hours

◇ Charging description

- ① Plug the AC adapter into an AC outlet; or the optional CP-21LR into a cigarette lighter socket.
- ② Insert the adapter plug into **[12~16V DC INPUT]** of the BC-164 BATTERY CHARGER.
- ③ Install the BP-243 BATTERY PACK (See left page) in the transceiver
- ④ Be sure to turn OFF the transceiver, then charge the battery with transceiver.
 - Takes approximately 3 hours to fully charge with the supplied BP-243 battery pack.

Charging indicator of BC -164

Orange (lights) : During charging.

Green (lights) : When the battery pack is charged completely.

Red (blinking) : The charger may be outside of the specified temperature range: +5°C to +35°C (+41°F to +95°F). Restore the specified temperature range and reinsert the transceiver or contact your dealer.

CAUTION: BE SURE to disconnect the CP-21LR from the cigarette lighter socket when charging is finished, because, a slight current still follows in the CP-21LR and the vehicle's battery will become will be drained.

■ VFO and memory channels

The IC-E7 has two primary operating modes: *VFO mode* and *memory mode*.

VFO mode is used for setting the desired frequency within the frequency coverage.

➔ Push **[V/M]** (**SKIP*S.MW**) to select *VFO mode*.

Memory mode is used for operating from memory channels which have programmed frequencies.

➔ Push **[V/M]** (**SKIP*S.MW**) to select *memory mode*.

• See p. 24 for memory programming details.

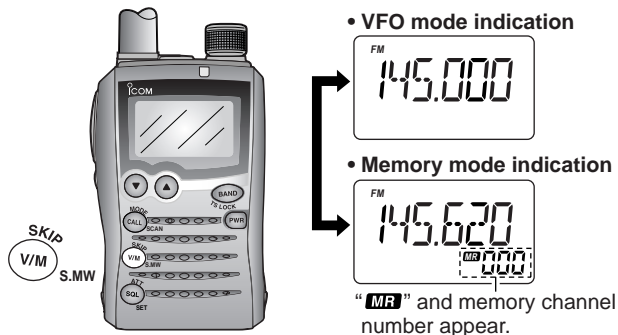

What is VFO?

VFO is an abbreviation of Variable Frequency Oscillator. Frequencies for receiving or transmitting are selected and controlled by the VFO.

■ Operating band selection

The transceiver can receive the *AM broadcast, *HF band, *50 MHz, *FM broadcast, *VHF air, 144 MHz, *300 MHz, 400 MHz, *600 MHz, *800 MHz or television channels.

/// *Available frequency bands are differ depending on version. See the specification for details. (p. 75)

➔ Push **[BAND]** (**TS*LOCK**) several times to select the desired frequency band.

• When *memory mode* is selected, push **[V/M]** (**SKIP*S.MW**) to select *VFO mode* first.

➔ While pushing and holding **[BAND]** (**TS*LOCK**), rotating **[DIAL]** also selects frequency band.

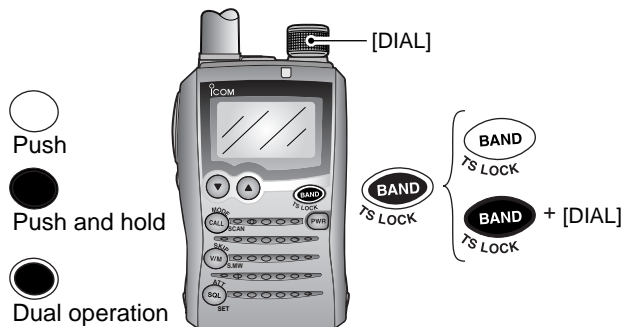

• Available frequency bands

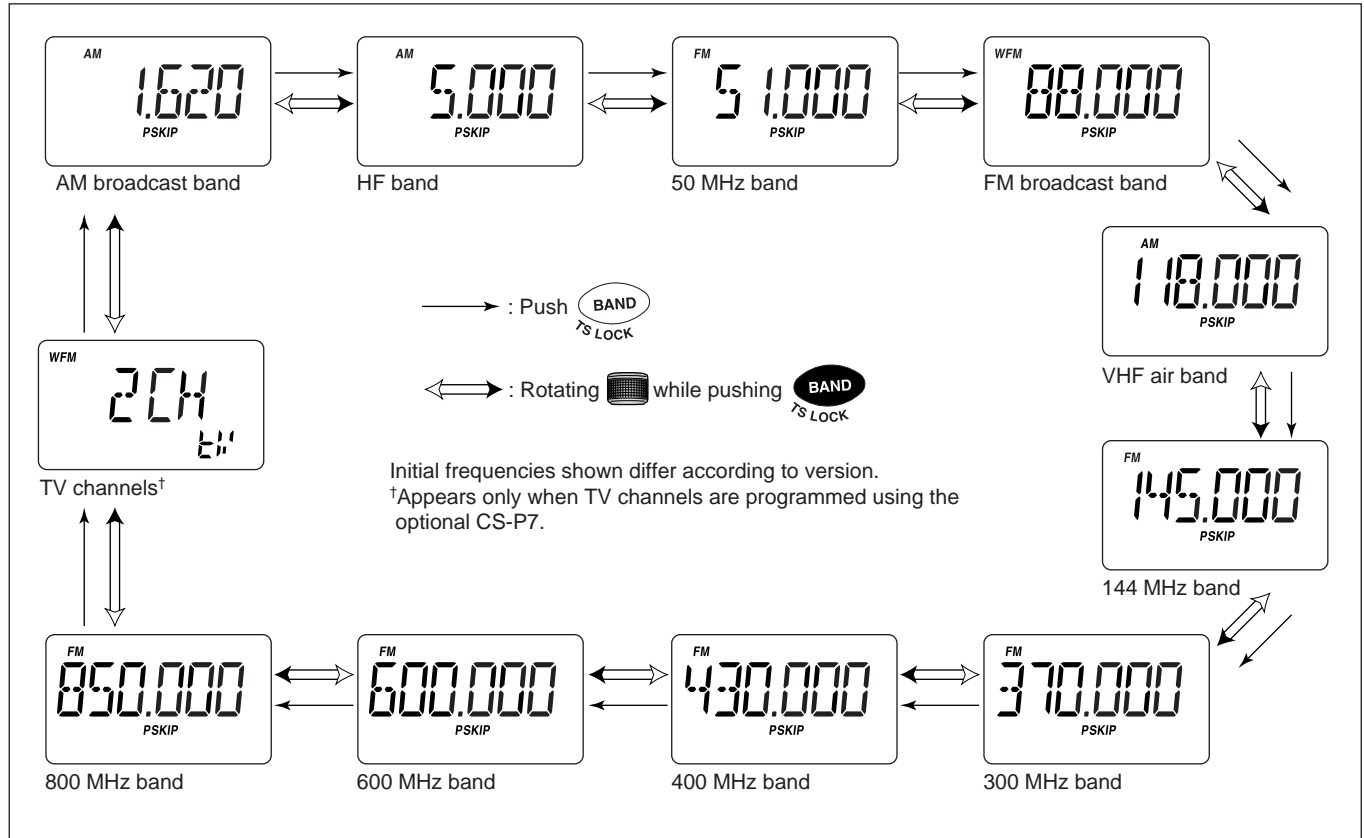

3 FREQUENCY AND CHANNEL SETTING

■ Setting a frequency

- ① Push **[V/M]** (**SKIP•S.MW**) to select *VFO mode*, if necessary.
- ② Select the desired frequency band with **[BAND]** (**TS•Lock**).
 - Or, while pushing and holding **[BAND]** (**TS•Lock**), rotate **[DIAL]** to select the desired frequency band.
- ③ Rotate **[DIAL]** to select the desired frequency.
 - The frequency changes according to the preset tuning steps. See the section at right for setting the tuning step.
 - While pushing and holding **[FUNC]**, rotate **[DIAL]** to change the frequency in 1 MHz steps (default).

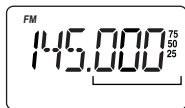
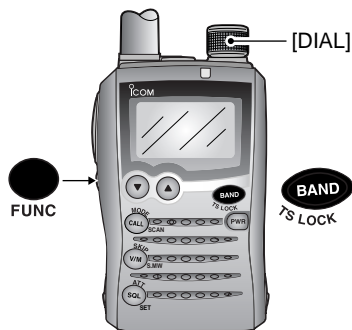

[DIAL] changes the frequency according to the selected tuning step.



While pushing **[FUNC]**, **[DIAL]** changes the frequency in 1 MHz steps (default).

▨ The 1 MHz tuning step (dial select step) can be set to 100 kHz, 1 MHz or 10 MHz tuning steps in *set mode*. See p. 17 for details.

■ Setting a tuning step

The tuning step can be selected for each frequency band. The following tuning steps are available for the IC-E7.

- 5.0 kHz* • 6.25 kHz* • 8.33 kHz† • 9.0 kHz† • 10.0 kHz
- 12.5 kHz • 15.0 kHz • 20.0 kHz • 25.0 kHz • 30.0 kHz
- 50.0 kHz • 100.0 kHz • 200.0 kHz

* Appears for below the 500 MHz bands only.

† Appears for the VHF air band only.

‡ Appears for the AM broadcast band only.

◆ Tuning step selection

- ① Push **[V/M]** (**SKIP•S.MW**) to select *VFO mode*, if necessary.
- ② Push **[BAND]** (**TS•Lock**) several times to select the desired frequency band.
 - Or, while pushing and holding **[BAND]** (**TS•Lock**), rotate **[DIAL]** to select the desired frequency band.
- ③ While pushing and holding **[FUNC]**, push **[BAND]** (**TS•Lock**) momentarily to enter *tuning step set mode*.
- ④ Rotate **[DIAL]** to select the desired tuning step.
- ⑤ Push **[BAND]** (**TS•Lock**) to return to *VFO mode*.

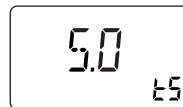

5 kHz tuning step

■ Selecting a memory channel

- ① Push **[V/M]** (**SKIP*s.MW**) momentarily to select *memory mode*.
 - “**MR**” appears when a memory channel is selected.
- ② Rotate **[DIAL]** to select the desired memory channel.
 - Only programmed memory channels can be selected.
 - While pushing and holding **[FUNC]**, rotate **[DIAL]** to select a memory channel in 10 channel steps, blank channels can be selected in this case.



[DIAL] changes the memory channel.

■ Selecting a call channel

- ① Push **[CALL]** (**MODE*SCAN**) momentarily to select a call channel.
- ② Rotate **[DIAL]** to select the desired call channel.



- ③ Push **[CALL]** (**MODE*SCAN**) or **[V/M]** (**SKIP*s.MW**) momentarily to return to the previously selected mode.

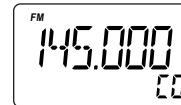

• Call channel example (depends on version)



144 MHz band



430 MHz band

 Push	 Push and hold	 Dual operation
---	--	---

■ Receiving

Make sure charged battery pack (BP-243) is installed (p. 7).

- ① Push and hold **[PWR]** for 1 sec. to turn power ON.
- ② Push **[▲]** or **[▼]** to set the desired audio level.
 - The frequency display shows the volume level while setting. See the section at right for details.
- ③ Set the receiving frequency. (p. 11)
- ④ Set the squelch level. (p. 14)
 - While pushing and holding **[SQL]** (**ATT•SET**), rotate **[DIAL]**.
 - The first click of **[DIAL]** indicates the current squelch level.
 - “LEVEL 1” is loose squelch (for weak signals) and “LEVEL 9” is tight squelch (for strong signals).
 - “AUTO” indicates automatic level adjustment by a noise pulse counting system.
 - Push and hold **[SQL]** (**ATT•SET**) to open the squelch manually.
- ⑤ When a signal is received:
 - TX/RX indicator lights green.
 - Squelch opens and audio is emitted.
 - The S/RF meter shows the relative signal strength level.

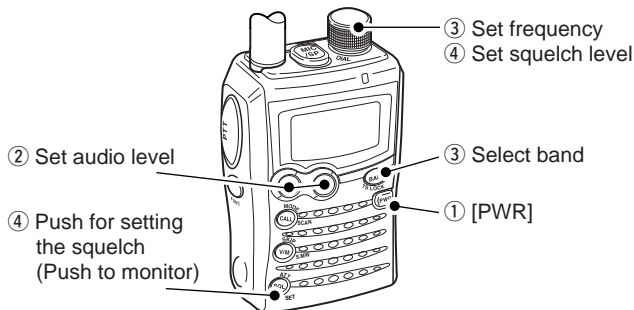

■ Setting audio volume

The audio level can be adjusted to one of 40 levels.

- Push **[▲]** or **[▼]** to adjust the audio level.
 - If squelch is closed, push and hold **[SQL]** (**ATT•SET**) to verify the audio level.
 - Pushing and holding either key changes the audio level continuously.
 - The display shows the volume level while setting.

INDICATION	AUDIO LEVEL
-----00	Minimum setting (no audio)
0-----01	•
00-----08	•
000-----16	•
0000-----19	Initial setting
0000-----24	•
00000-----32	•
000000-----39	Maximum setting



■ Squelch level setting

The squelch circuit mutes the received audio signal depending on the signal strength. The transceiver has 9 squelch levels, a continuously open setting and an automatic squelch setting.

- While pushing and holding **[SQL]** (**ATT•SET**), rotate **[DIAL]** to select the squelch level.
 - “LEVEL 1” is loose squelch (for weak signals) and “LEVEL 9” is tight squelch (for strong signals).
 - “AUTO” indicates automatic level adjustment by a noise pulse counting system.
 - “OPEN” indicates continuously open setting.

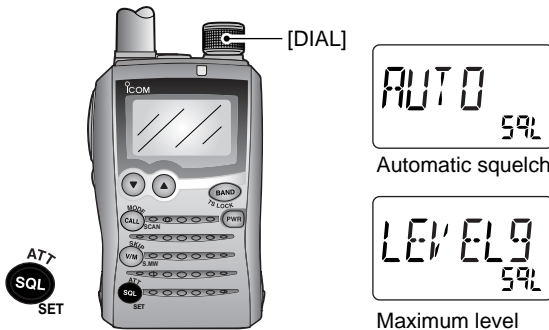

	Push		Push and hold		Dual operation
--	------	--	---------------	--	----------------

■ Operating mode selection

Operating modes are determined by the modulation of the radio signals. The transceiver has 3 operating modes: FM, AM and WFM modes. The mode selection is stored independently in each band and memory channels.

Typically, AM mode is used for the AM broadcast stations (0.495–1.620 MHz) and air band (118–135.995 MHz), and WFM is used for FM broadcast stations (76–107.9 MHz). WFM mode cannot be selected below 30 MHz bands.

- While pushing and holding **[FUNC]**, push **[CALL]** (**MODE•SCAN**) several times to select the desired operating mode.



4 BASIC OPERATION

■ Monitor function

This function is used to listen to weak signals without disturbing the squelch setting or to open the squelch manually even when mute functions such as the tone squelch are in use.

- ➔ Push and hold **[SQL] (ATT•SET)** to monitor the operating frequency.



The 1st segment blinks

/// The **[SQL] (ATT•SET)** key can be set to 'sticky' operation in *expanded set mode*. See page 56 for details.

■ Attenuator function

The attenuator prevents distortion of a desired signal when very strong RF signals are near the desired frequency or when very strong electric fields, such as from a broadcasting station, are present at your location.

- ➔ While pushing and holding **[FUNC]**, push **[SQL] (ATT•SET)** momentarily to toggle the attenuator function ON and OFF.
 - "ATT" appears when the attenuator functions is in use.

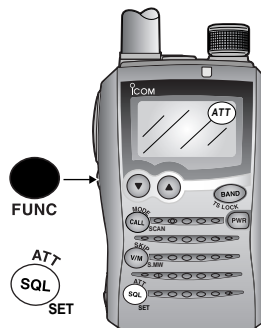

○ Push ● Push and hold ● Dual operation

■ Transmitting

CAUTION: Transmitting without an antenna will damage the transceiver.

NOTE: To prevent interference, listen on the channel before transmitting by pushing and holding **[SQL] (ATT•SET)**.

- ① Set the operating frequency. (pgs. 9, 11)
 - Transmission is available on the 144 MHz/430 MHz (FM mode) amateur bands only.
 - Select output power if desired. See the section at right for details.
- ② Push and hold **[PTT]** to transmit.
 - TX/RX indicator lights red.
 - S/RF meter shows the output power level.
- ③ Speak into the microphone using your normal voice level.
 - DO NOT hold the transceiver too close to your mouth or speak too loudly. This may distort the signal.
- ④ Release **[PTT]** to return to receive.

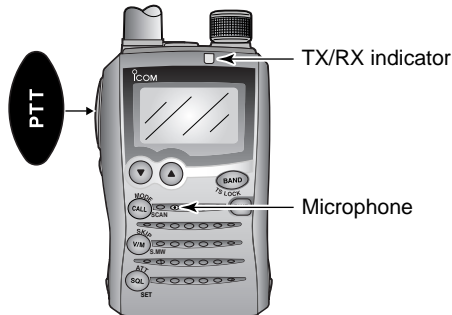

■ Transmit power selection

The transceiver has two output power levels to suit your operating requirements. Low output power during short-range communications may reduce the possibility of interference to other stations and will reduce current consumption.

- ➔ While pushing and holding **[FUNC]**, push **[PTT]** to toggle the transmit output power between High and Low.
 - "LOW" appears when the low power is selected.

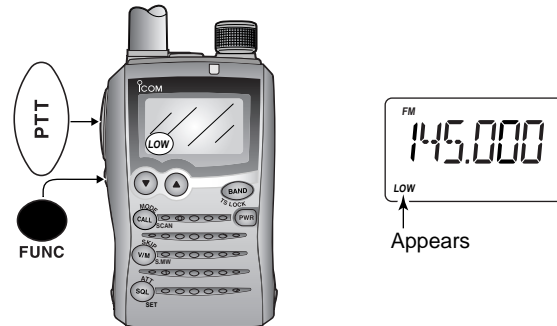

4 BASIC OPERATION

■ Dial select step

This transceiver has a 1 MHz tuning step for quick frequency setting. This dial select step can be set to 100 kHz, 1 MHz or 10 MHz steps, as desired.

◆ Setting dial select step

- ① Select *VFO mode* with **[V/M]** (**SKIP•S.MW**).
- ② While pushing and holding **[FUNC]**, push and hold **[SQL]** (**ATT•SET**) for 1 sec. to enter *set mode*.

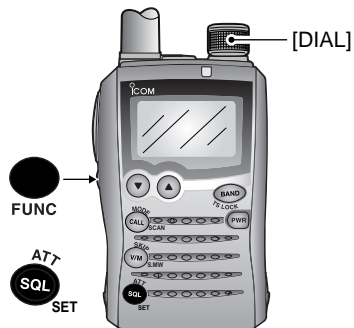

- ③ Rotate **[DIAL]** to select "D SEL."



USING *SET MODE*

- ④ While pushing and holding **[FUNC]**, rotate **[DIAL]** to select the desired dial select step.

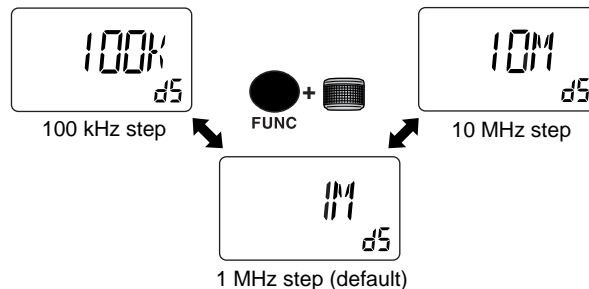

- ⑤ Push **[SQL]** (**ATT•SET**) momentarily to exit *set mode*.

○ Push ● Push and hold ◐ Dual operation

■ Lock function

To prevent accidental frequency changes and unnecessary function activation, use the lock function.

- ➔ While pushing and holding **[FUNC]**, push and hold **[BAND] (TS•LOCK)** for 1 sec. to turn the lock function ON and OFF.
 - “L” appears while the lock function is active.
 - **[SQL] (ATT•SET)** and **[▲]/[▼]** can be used while the lock function is in use in default setting. Either or both **[SQL] (ATT•SET)** and **[▲]/[▼]** keys may also be locked in *set mode*. (p. 56)



■ [DIAL] function assignment

The **[DIAL]** control can be used as an audio volume control instead of **[▲]/[▼]** keys to suit your preference. However, while **[DIAL]** functions as an audio volume, **[▲]/[▼]** keys function as tuning controls.

- ➔ While pushing and holding **[FUNC]**, push **[▲]/[▼]** to toggle the **[DIAL]** function between tuning dial and audio volume.
 - “VOL” appears when **[DIAL]** functions as an audio volume.

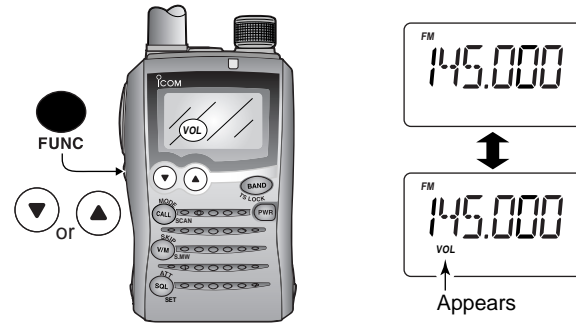

• [DIAL] and [▲]/[▼] functions

	No “VOL” indication	“VOL” appears
[DIAL]	Frequency, Memory channel, Squelch level, Scanning direction, Set mode item and condition set	Audio volume set Set mode condition set
[▲]/[▼]	Audio volume set	Frequency, Memory channel, Squelch level, Scanning direction, Set mode item

■ General

When using a repeater, the transmit frequency is shifted from the receive frequency by the amount of the offset frequency. It is convenient to program repeater information, such as offset and access tone, into memory channels.

- ① Set the receive frequency (repeater output frequency).
- ② Set the shift direction of the transmit offset frequency. (-DUP or +DUP; see the next section for details.)
 - “-DUP” or “+DUP” indicates a minus or plus offset of the transmit frequency, respectively.
- ③ Activate the subaudible tone encoder, according to repeater requirements.
 - Refer to page 21 for tone frequency settings.
- ④ Push and hold **[PTT]** to transmit.
 - The displayed frequency automatically changes to the transmit frequency (repeater input frequency).
 - If “OFF” appears, check the offset frequency (see next page for details) or shift direction (see section at right).
- ⑤ Release **[PTT]** to receive.
- ⑥ Push and hold **[SQL] (ATT•SET)** to check whether the other station’s transmit signal can be received directly on the repeater’s input frequency.

◇ Setting duplex and duplex direction

- ① While pushing and holding **[FUNC]**, push and hold **[SQL] (ATT•SET)** for 1 sec. to enter *set mode*.

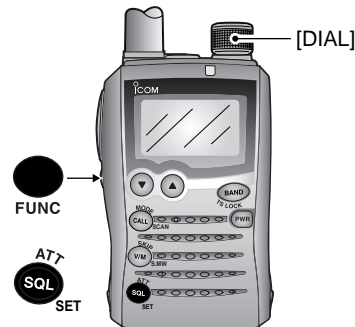

- ② Rotate **[DIAL]** to select “DUP.”



- ③ While pushing and holding **[FUNC]**, rotate **[DIAL]** to select “-DUP” or “+DUP.”
- ④ Push **[SQL] (ATT•SET)** to exit *set mode*.
- ⑤ Push and hold **[SQL] (ATT•SET)** to monitor the repeater input frequency.

■ Offset frequency

When communicating through a repeater, the transmit frequency is shifted from the receive frequency by the amount of the offset frequency.

- ① While pushing and holding **[FUNC]**, push and hold **[SQL] (ATT•SET)** for 1 sec. to enter *set mode*.

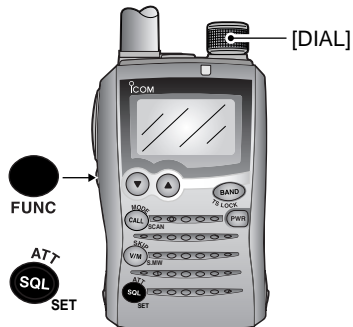

- ② Rotate **[DIAL]** to select “OFFSET.”

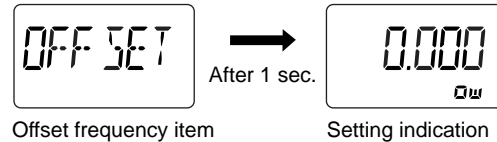

- ③ While pushing and holding **[FUNC]**, rotate **[DIAL]** to set the desired offset frequency within 0.000–159.995 MHz range.
- The tuning step, selected in *VFO mode*, is used for setting.
- ④ Push **[SQL] (ATT•SET)** to exit *set mode*.

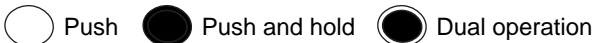

5 REPEATER OPERATION

■ Subaudible tones

To be accessed, some repeaters require subaudible tones on the input signal. Subaudible tones are added to your normal signal and must be set in advance.

◆ Setting the subaudible tone frequency

- ① While pushing and holding **[FUNC]**, push and hold **[SQL]** (**ATT•SET**) for 1 sec. to enter *set mode*.

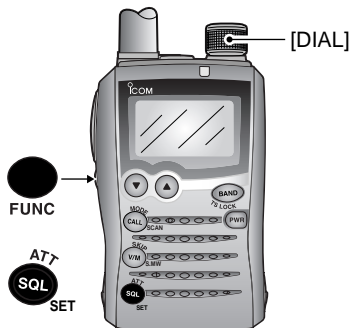

- ② Rotate **[DIAL]** to select "R TONE."



- ③ While pushing and holding **[FUNC]**, rotate **[DIAL]** to select the desired subaudible tone frequency.
 - See the tables at right.
- ④ Push **[SQL]** (**ATT•SET**) to exit *set mode*.

• Available tone frequency list

67.0	79.7	94.8	110.9	131.8	156.7	171.3	186.2	203.5	229.1
69.3	82.5	97.4	114.8	136.5	159.8	173.8	189.9	206.5	233.6
71.9	85.4	100.0	118.8	141.3	162.2	177.3	192.8	210.7	241.8
74.4	88.5	103.5	123.0	146.2	165.5	179.9	196.6	218.1	250.3
77.0	91.5	107.2	127.3	151.4	167.9	183.5	199.5	225.7	254.1

NOTE: The transceiver has 50 tone frequencies and consequently their spacing is narrow compared to units having 38 tones. Therefore, systems using some tone frequencies may receive interference from signals using adjacent tone frequencies.

✓ CONVENIENT!

Tone scan function: When you don't know the subaudible tone used for a repeater, the tone scan is convenient for detecting the tone frequency. (p. 48)

While pushing and holding **[FUNC]**, pushing and holding **[CALL]** (**MODE•SCAN**) for 1 sec. to start the repeater tone scan.

- Push **[CALL]** (**MODE•SCAN**) to cancel the scan.
- When the required tone frequency is detected, the scan pauses.

◆ Setting the subaudible tone encoder ON/OFF

① While pushing and holding [FUNC], push and hold [SQL] (ATT*SET) for 1 sec. to enter set mode.

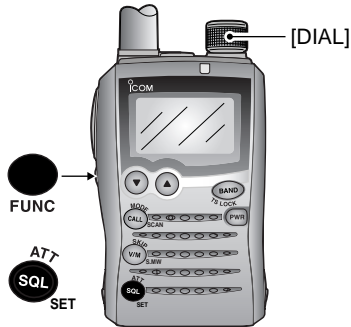

② Rotate [DIAL] to select "T/TSQL."



③ While pushing and holding [FUNC], rotate [DIAL] to select the repeater tone from "TONE" or "OFF."

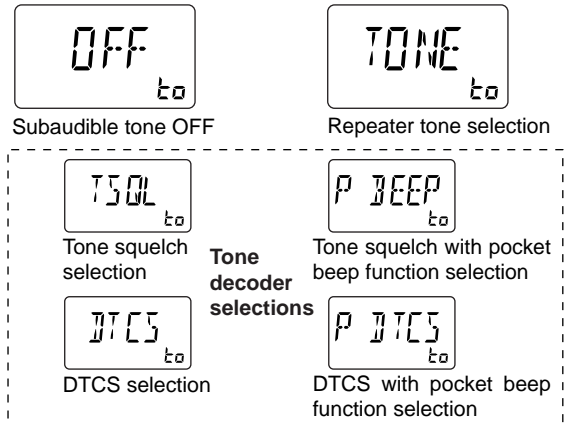

④ Push [SQL] (ATT*SET) to exit set mode.

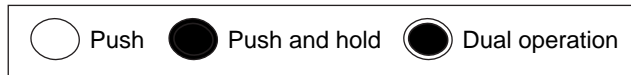

5 REPEATER OPERATION

■ 1750 Hz tone

Some European repeaters require a 1750 Hz tone burst to be accessed. For such European repeaters, perform the following.

- ① Set the receive frequency (repeater output frequency).
- ② Set the shift direction of the transmit frequency. (-DUP or +DUP; see p. 19 for details.)
 - “-DUP” or “+DUP” indicates a minus or plus offset of the transmit frequency, respectively.
- ③ While pushing and holding **[PTT]**, push and hold **[SQL] (ATT•SET)** for 1 to 2 sec. to transmit a 1750 Hz tone burst signal.
 - The displayed frequency automatically changes to the transmit frequency (repeater input frequency).
 - If “OFF” appears, check the offset frequency (see p. 20 for details) or shift direction (p.19).
- ④ Push and hold **[PTT]** to transmit.
- ⑤ Release **[PTT]** to receive.
- ⑥ Push and hold **[SQL] (ATT•SET)** to monitor the repeater input frequency.

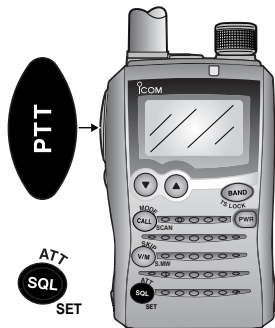

✓ CONVENIENT!

- ① Set the receive frequency, or shift direction (see p.19 for details.).
- ② Push **[PTT]** briefly, then push and hold **[PTT]** again for 1 to 2 sec. to transmit a 1750 Hz tone burst signal.
 - The displayed frequency automatically changes to the transmit frequency (repeater input frequency).
 - If “OFF” appears, check the offset frequency (see p. 20 for details) or shift direction (p.19).
- ③ Push and hold **[PTT]** to transmit.
- ④ Release **[PTT]** to receive.
- ⑤ Push and hold **[SQL] (ATT•SET)** to monitor the repeater input frequency.

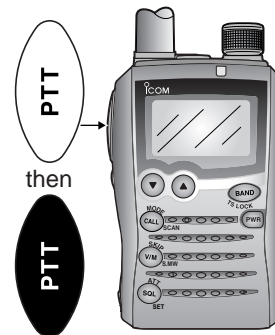

■ General description

The IC-E7 has 1050 memory channels including 50 scan edge memory channels (25 pairs) for storage of often-used frequencies. And a total of 18 memory banks, A to H, J, L, N, O to R, T, U and Y are available for storing groups of frequencies, etc. Up to 100 channels can be assigned into a bank.

◆ Memory channel contents

The following information can be programmed into memory channels:

- Operating frequency (p. 11)
- Operating mode (p. 14)
- Duplex direction (DUP or -DUP) with an offset frequency (pgs. 19, 20)
- Subaudible tone encoder (p. 22), tone squelch or DTCS squelch ON/OFF (p. 45)
- Subaudible tone frequency (p. 21), tone squelch frequency or DTCS code with polarity (pgs. 46, 47)
- Scan skip information (p. 39).

■ Memory channel programming

- ① Push **[V/M] (SKIP*s.MW)** to select *VFO mode*.
- ② Set the desired frequency:
 - Select the desired band with **[BAND] (TS*LOCK)**.
 - Set the desired frequency with **[DIAL]**.
 - Set other data (e.g. offset frequency, duplex direction, sub-audible tone frequency, etc.), if desired.
- ③ Push and hold **[V/M] (SKIP*s.MW)** for 1 sec. to enter *select memory write mode*.
 - 1 short and 1 long beep sound.
 - “**MR**” indicator and memory channel number blink.
- ④ Rotate **[DIAL]** to select the desired channel.
 - Call channels (C0, C1), VFO (VF) and scan edge channels (00A/00b to 24A/24b), as well as regular memory channels, can be programmed in this way.
 - While pushing and holding **[FUNC]**, rotate **[DIAL]** to select memory channel in 10 channel steps.
- ⑤ Push and hold **[V/M] (SKIP*s.MW)** for 1 sec.
 - 3 beeps sound
 - Memory channel number automatically increases when continuing to push **[V/M] (SKIP*s.MW)** after programming.

5

6

[EXAMPLE]: Programming 439.370 MHz into memory channel 20 (blank channel).

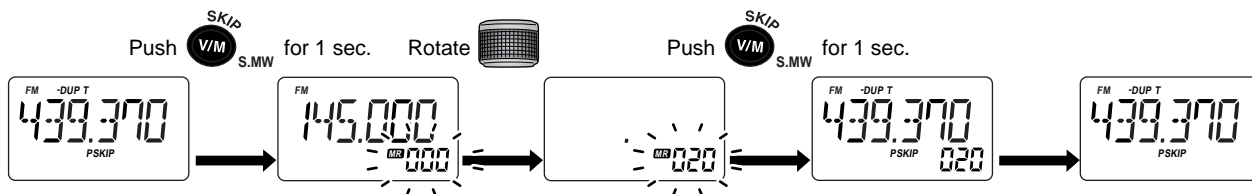

6 MEMORY/CALL CHANNELS

■ Memory bank setting

The IC-E7 has a total of 18 banks (A to H, J, L, N, O to R, T, U and Y). Regular memory channels, 000 to 999, may assigned into a desired bank for easy memory management.

- ① Push and hold **[V/M]** (**SKIP*****S.MW**) for 1 sec. to enter *select memory write mode*.
 - 1 short and 1 long beep sound.
 - “**MB**” indicator and memory channel number blink.
- ② Rotate **[DIAL]** to select the desired memory channel.
- ③ While pushing and holding **[CALL]** (**MODE*****SCAN**), rotate **[DIAL]** to select “**BANK**.”
 - After releasing **[CALL]** (**MODE*****SCAN**), “- - - - -” is displayed instead of the frequency indication, and only “**MB**” indicator blinks.
 - Bank group and channel number is displayed if the selected memory channel has already been assigned to a bank.
 - “**BANK**” can also be selected by pushing **[CALL]** (**MODE*****SCAN**) several times.

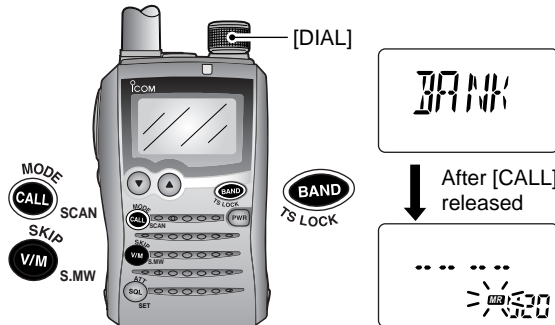

- ④ While pushing and holding **[BAND]** (**TS*****LOCK**), rotate **[DIAL]** to select the desired bank.
 - Banks A to H, J, L, N, O to R, T, U and Y are available.
 - The bank can also be selected by pushing **[BAND]** (**TS*****LOCK**) several times.



- ⑤ Rotate **[DIAL]** to select the desired bank channel number.
 - Vacant bank channel numbers are only be displayed.

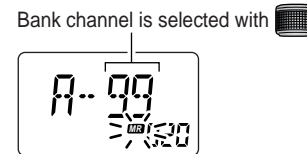

- ⑥ Push and hold **[V/M]** (**SKIP*****S.MW**) for 1 sec. to set the channel into the bank.
 - Return to the previous indication.

Memory bank selection

- ① Push [V/M] (SKIP•S.MW) to select *memory mode*, if desired.
- ② While pushing and holding [BAND] (TS•LOCK), rotate [DIAL] to select the desired bank (A to H, J, L, N, O to R, T, U and Y).
 - The bank can also be selected by pushing [BAND] (TS•LOCK) several times.
 - The only programmed banks are displayed.

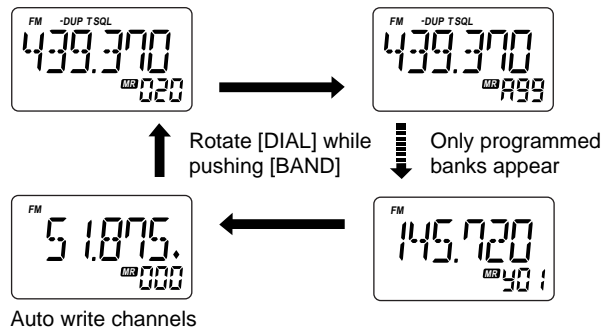

- ③ Rotate [DIAL] to select the bank channel.
 - Only programmed channels are displayed.



- ④ To return to regular memory operation, rotate [DIAL] while pushing and holding [BAND] (TS•LOCK), or push [BAND] (TS•LOCK) several times.

○ Push ● Push and hold ● Dual operation

6 MEMORY/CALL CHANNELS

■ Programming memory/bank name

Each memory channel can be programmed with an alphanumeric channel name for easy recognition and that can be indicated independently by channel. Names can be a maximum of 6 characters.

- ① Push **[V/M]** (**SKIP•S.MW**) to select *memory mode*.
- ② Rotate **[DIAL]** to select the desired memory channel.
- ③ Push and hold **[V/M]** (**SKIP•S.MW**) for 1 sec. to enter *select memory write mode*.
 - 1 short and 1 long beep sound.
 - “**MR**” indicator and memory channel number blink.

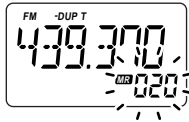

- ④ While pushing and holding **[CALL]** (**MODE•SCAN**), rotate **[DIAL]** to select “M NAME” or “B NAME” when programming the memory name or the bank name, respectively.
 - Name type can also be selected by pushing **[CALL]** (**MODE•SCAN**) several times.
 - After releasing **[CALL]** (**MODE•SCAN**), an under bar blinks for the first digit instead of the frequency indication, and only “**MR**” indicator blinks.

Memory name selection

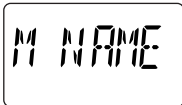

Bank name selection

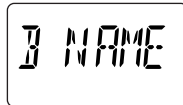

- ⑤ While pushing and holding **[FUNC]**, rotate **[DIAL]** to select the desired character.
 - The selected character blinks.

- ⑥ Rotate **[DIAL]** to move the cursor to left or right.

Memory name

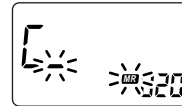

Bank name

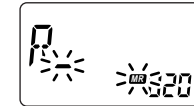

- ⑦ Repeat steps ⑤ and ⑥ until the desired 6-character channel names are displayed.
- ⑧ Push **[CALL]** (**MODE•SCAN**) several times, or rotate **[DIAL]** while pushing and holding **[CALL]** (**MODE•SCAN**) to select “S.MW.”

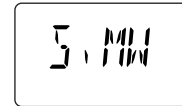

- ⑨ Push and hold **[V/M]** (**SKIP•S.MW**) for 1 sec. to program the name and exit the channel name programming.
 - 3 beeps sound.

• Available characters

A to Z, 0 to 9, (,), *, +, -, ., /, :, = and space.

■ Selecting display type

During *memory mode* operation, the programmed memory name, bank name or the channel number can be displayed instead of the frequency at your preference.

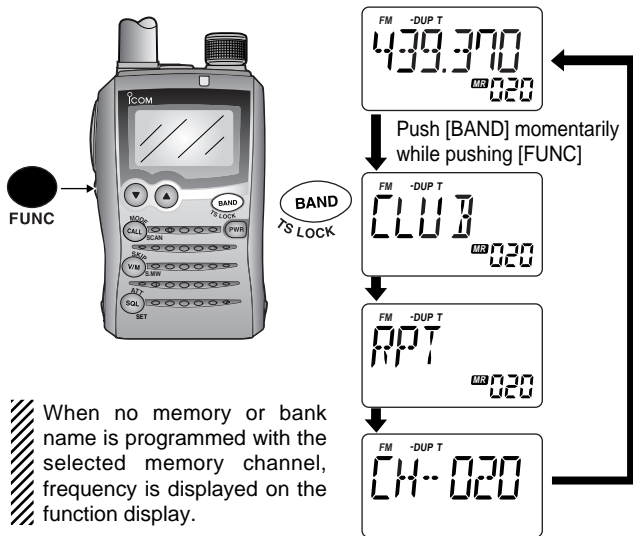

- ① Push [V/M] (SKIP•S.MW) to select *memory mode*.
 • [BAND] (TS•LOCK) to select the desired bank.
- ② While pushing and holding [FUNC], push [BAND] (TS•LOCK) momentarily to select display type from frequency, bank name, memory name and channel number display.

◇ Selecting bank channel indication

During bank channel operation, the bank channel number can also be displayed instead of the memory channel number indication.

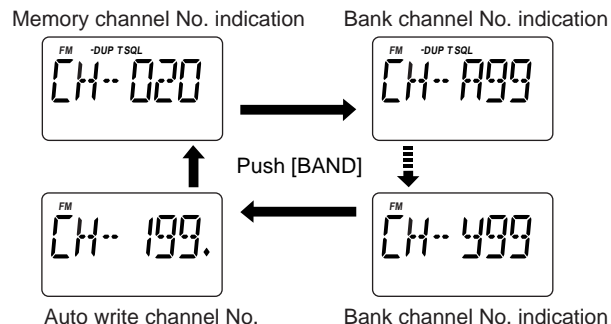

- After selecting channel number indication as described at left, push [BAND] (TS•LOCK) to select the desired bank.
 Or while pushing and holding [BAND] (TS•LOCK), rotate [DIAL] to select the desired bank.

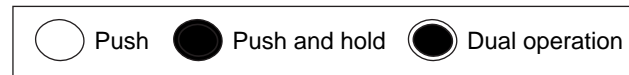

■ Copying memory contents

This function transfers a memory channel's contents to a VFO (or another memory channel). This is useful when searching for signals around a memory channel frequency and for recalling the offset frequency, subaudible tone frequency etc.

◇ Memory ↔ VFO

- ① Select the memory channel to be copied.
 - Push **[V/M] (SKIP•S.MW)** momentarily to select *memory mode*, then rotate **[DIAL]** to select the desired memory channel.
 - Select the bank channel with **[BAND] (TS•LOCK)** and **[DIAL]**, if desired.
- ② Push and hold **[V/M] (SKIP•S.MW)** for 1 sec. to enter *select memory write mode*.
 - 1 short and 1 long beep sound.
 - “**MR**” indicator and memory channel number blink.
- ③ Rotate **[DIAL]** to select “VF.”
- ④ Push and hold **[V/M] (SKIP•S.MW)** for 1 sec. again.
 - *VFO mode* is selected automatically.

/// Pushing and holding **[V/M] (SKIP•S.MW)** for 2 sec. at the step ②, can also copies the memory contents to VFO. In this case, steps ③ and ④ are not necessary.

◇ Memory ↔ memory

- ① Select the memory channel to be transferred.
 - Push **[V/M] (SKIP•S.MW)** to select *memory mode*, then rotate **[DIAL]** to select the desired memory channel.
- ② Push and hold **[V/M] (SKIP•S.MW)** for 1 sec. to enter *select memory write mode*.
 - 1 short and 1 long beep sound.
 - “**MR**” indicator and memory channel number blink.
 - Do not hold **[V/M] (SKIP•S.MW)** for more than 1 sec. otherwise the memory contents will be copied to VFO.
- ③ Rotate **[DIAL]** to select the target memory channel.
- ④ Push and hold **[V/M] (SKIP•S.MW)** for 1 sec. again to transfer.

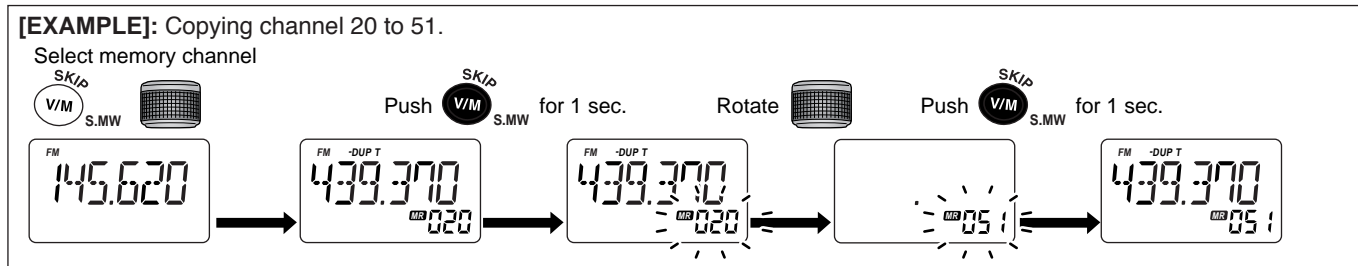

Memory clearing

Contents of programmed memories can be cleared (blanked), if desired.

- ① Push and hold **[V/M] (SKIP•S.MW)** for 1 sec. to enter *select memory write mode*.
 - 1 short and 1 long beeps sound.
 - “**MR**” indicator and memory channel number blink.
 - Do not hold **[V/M] (SKIP•S.MW)** for more than 2 sec. otherwise the memory contents will be copied to VFO.
- ② Rotate **[DIAL]** to select the desired memory channel to be cleared.
- ③ While pushing and holding **[CALL] (MODE•SCAN)**, rotate **[DIAL]** to select “CLEAR.”
 - “CLEAR” item can also be selected by pushing **[CALL] (MODE•SCAN)** several times.

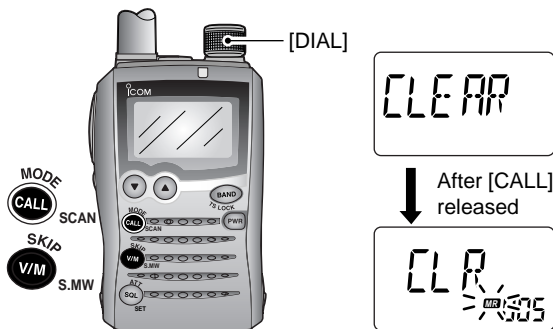

- ④ Push and hold **[V/M] (SKIP•S.MW)** for 1 sec. to clear the contents.
 - 3 beeps sound.
 - Return to VFO or *memory mode*, if VFO is selected before performing step ①.
 - Return to *select memory write mode* if *memory mode* is selected before performing step ①.— “**MR**” indicator and memory channel number blink. Push **[V/M] (SKIP•S.MW)** momentarily to return to *memory mode*.

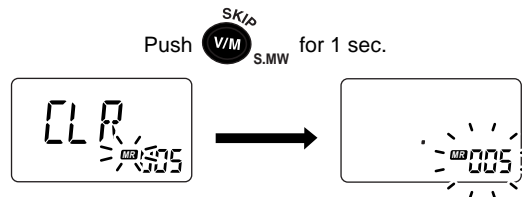

Push **[V/M] (SKIP•S.MW)** for 1 sec.

While pushing and holding **[FUNC]**, push and hold **[V/M] (SKIP•S.MW)** for 1 sec. after step ② also clears the memory contents. In this case, steps ③ and ④ are not necessary.

NOTE: Be careful!— the contents of cleared memories CANNOT be re-called even in bank channel operation.

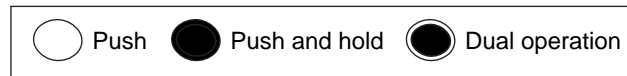

6 MEMORY/CALL CHANNELS

■ Transferring memory contents

Contents of programmed memory channels can be transferred to another memory channels.

- 1 Push and hold **[V/M]** (**SKIP•S.MW**) for 1 sec. to enter *select memory write mode*.
 - 1 short and 1 long beeps sound.
 - “**MR**” indicator and memory channel number blink.
 - Do not hold **[V/M]** (**SKIP•S.MW**) for more than 2 sec. otherwise the memory contents will be copied to VFO.
- 2 Rotate **[DIAL]** to select the desired memory channel to be transferred.
- 3 While pushing and holding **[CALL]** (**MODE•SCAN**), rotate **[DIAL]** to select “CLEAR.”
 - Pushing **[CALL]** (**MODE•SCAN**) several times also “CLEAR” item is selectable.
- 4 Push and hold **[V/M]** (**SKIP•S.MW**) for 1 sec.
 - The displayed contents are cleared.

/// **CONVENIENT!:**

Instead of steps ③ and ④ operations, while pushing and holding **[FUNC]**, push and hold **[V/M]** (**SKIP•S.MW**) for 1 sec. also clearing the contents.

- 5 Rotate **[DIAL]** to select the desired target memory channel.
- 6 Push and hold **[V/M]** (**SKIP•S.MW**) for 1 sec. to transfer the contents.



- **Example**— Transferring the contents of memory channel 20 to channel 30.

Steps ① and ②



Step ③



Step ④



Step ⑤

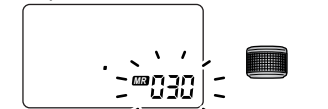

Step ⑥



■ Erasing/transferring bank contents

The bank contents of programmed memory channels can be cleared or reassigned to another memory bank.

/// INFORMATION: Even if the memory bank contents are cleared, the memory channel contents still remain programmed.

- ① Select the desired bank contents to be transferred or erased from the bank.
 - ➔ Push **[V/M]** (SKIP•S.MW) to select *memory mode*.
 - ➔ While pushing and holding **[BAND]** (TS•LOCK), rotate **[DIAL]** to select the desired memory bank.
 - ➔ Rotate **[DIAL]** to select the bank channel.
- ② Push and hold **[V/M]** (SKIP•S.MW) for 1 sec. to enter *select memory write mode*.
 - 1 short and 1 long beeps sound.
 - Displays the original memory channel number automatically and “**MB**” indicator and memory channel number blink.
 - Do not hold **[V/M]** (SKIP•S.MW) for more than 2 sec. otherwise the bank contents will be copied to VFO.

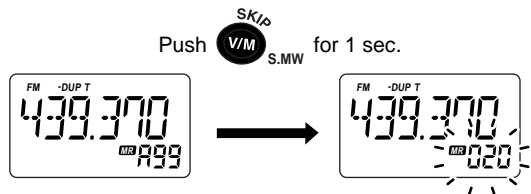

- ③ While pushing and holding **[CALL]** (MODE•SCAN), rotate **[DIAL]** to select “BANK.”
 - Pushing **[CALL]** (MODE•SCAN) several times, “BANK” is also selectable.
- ④ While pushing and holding **[BAND]** (TS•LOCK), rotate **[DIAL]** to select the desired bank to receive the transferred information or erase the bank contents.
 - Select “- - - - -” indication when erasing the contents from the bank.

When transferring

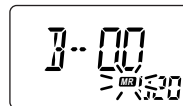

When erasing

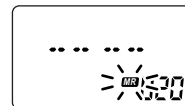

- ⑤ Rotate **[DIAL]** to select the desired bank channel.
- ⑥ While pushing and holding **[CALL]** (MODE•SCAN), rotate **[DIAL]** to select “S.MW.”
 - Pushing **[CALL]** (MODE•SCAN) several times, “S.MW” is also selectable.
- ⑦ Push and hold **[V/M]** (SKIP•S.MW) for 1 sec.
 - 3 beeps sound.

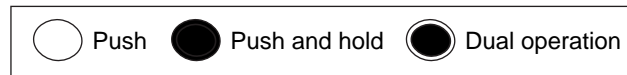

6 MEMORY/CALL CHANNELS

■ Call channel programming

- ① Push **[V/M] (SKIP•S.MW)** to select *VFO mode*, if necessary.
- ② Set the desired frequency:
 - ➔ Select the desired band with **[BAND] (TS•LOCK)**.
 - ➔ Set the desired frequency with **[DIAL]**.
 - ➔ Set other data (e.g. offset frequency, duplex direction, sub-audible tone frequency, etc.), if desired.
- ③ Push and hold **[V/M] (SKIP•S.MW)** for 1 sec. to enter *select memory write mode*.
 - 1 short and 1 long beep sound.
 - “**MR**” indicator and memory channel number blink.
- ④ Rotate **[DIAL]** to select the desired call channel.
 - “**MR**” indicator and call channel number “C0” or “C1” blink.
 - While pushing and holding **[FUNC]**, rotate **[DIAL]** to select memory channel in 10 channel steps.
- ⑤ Push and hold **[V/M] (SKIP•S.MW)** for 1 sec.
 - 3 beeps sound



■ Copying call channel contents

- ① Push **[CALL] (MODE•SCAN)** momentarily to select a call channel.
- ② Rotate **[DIAL]** to select the desired call channel.
- ③ Push and hold **[V/M] (SKIP•S.MW)** for 1 sec. to enter *select memory write mode*.
 - 1 short and 1 long beeps sound.
 - “**MR**” indicator and memory channel number blink.
 - Do not hold **[V/M] (SKIP•S.MW)** for more than 2 sec. otherwise the call channel contents will be copied to VFO.
- ④ Rotate **[DIAL]** to select the desired target memory channel.
- ⑤ Push and hold **[V/M] (SKIP•S.MW)** for 1 sec. to transfer the contents.



/// **CONVENIENT!:**

When you want to copy the call channel contents to the VFO, push and hold **[V/M] (SKIP•S.MW)** for 2 sec. as in steps ③.

■ Scan types

Scanning searches for signals automatically and makes it easier to locate new stations for contact or listening purposes.

There are 7 scan types and 4 resume conditions to suit your operating needs.

FULL SCAN (p. 35)

Repeatedly scans all frequencies over all bands.

Some frequency ranges are not scanned according to the frequency coverage of the transceiver's version.

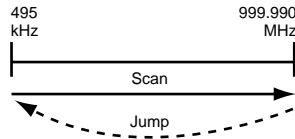

SELECTED BAND SCAN (p. 35)

Repeatedly scans all frequencies over the entire selected band.

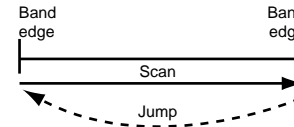

PROGRAMMED SCAN (p. 35)

Repeatedly scans between two user-programmed frequencies. Used for checking for frequencies within a specified range such as repeater output frequencies, etc.

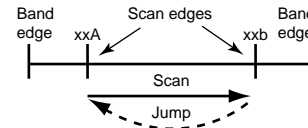

MEMORY (SKIP) SCAN (p. 37)

Repeatedly scans memory channels except those set as skip channels. Skip channels can be turned ON and OFF by pushing **[FUNC] + [V/M]** (**SKIP*s.MW**) in *memory mode*.

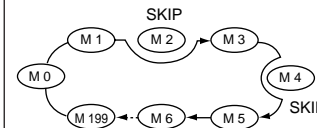

ALL/SELECTED BANK SCAN (p. 37)

Repeatedly scans all bank channels or selected bank channels. Skip scan is also available.

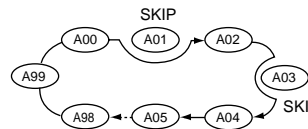

FREQUENCY/MEMORY SKIP FUNCTION (p. 39)

Skips unwanted frequencies or channels that inconveniently stop scanning. This function can be turned ON and OFF by pushing **[FUNC] + [V/M]** (**SKIP*s.MW**) in either VFO or *memory mode*.

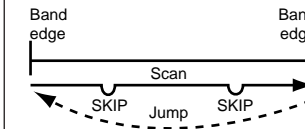

■ Full/band/programmed scan

- ① Select *VFO mode* with [V/M] (SKIP•S.MW), if necessary.
 - Select the desired frequency band with [BAND] (TS•LOCK), if desired.
- ② Set the squelch to the point where noise is just muted.
- ③ Push and hold [CALL] (MODE•SCAN) for 1 sec. to enter scan type selection condition.
- ④ Rotate [DIAL] to select the desired scanning type.
 - “ALL” for full scan; “BAND” for band scan, “PROGxx” for programmed scan (xx= 0 to 24; programmed scan edges numbers only displayed)



• Full scan selection

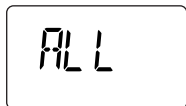

• Band scan selection



• Programmed scan selection



Selectable between “0” to “24” if programmed

- ⑤ Push [CALL] (MODE•SCAN) again to start the scan
 - Scan pauses when a signal is received.
 - Rotate [DIAL] to change the scanning direction, or resumes manually.
 - To stop the scan, push [CALL] (MODE•SCAN).

• During full/band scan

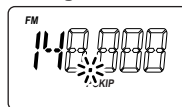

• During programmed scan



/// **About the scanning steps:** The selected tuning step in each frequency band (in *VFO mode*) is used during scan.

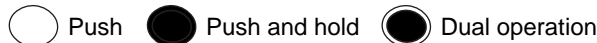

■ Scan edges programming

Scan edges can be programmed in the same manner as memory channels. Scan edge frequencies are programmed into scan edges, 00A/00b to 24A/24b, in memory channels.

- ① Push **[V/M]** (**SKIP•S.MW**) to select *VFO mode*, if necessary.
- ② Set the desired frequency:
 - ➔ Select the desired band with **[BAND]** (**TS•LOCK**).
 - ➔ Set the desired frequency with **[DIAL]**.
 - ➔ Set other data (e.g. offset frequency, duplex direction, sub-audible tone frequency, etc.), if desired.
- ③ Push and hold **[V/M]** (**SKIP•S.MW**) for 1 sec. to enter *select memory write mode*.
 - 1 short and 1 long beeps sound.
 - “**MR**” indicator and memory channel number blink.
- ④ Rotate **[DIAL]** to select the desired programmed scan edge channel from 00A to 24A.

- ⑤ Push and hold **[V/M]** (**SKIP•S.MW**) for 1 sec.
 - 3 beeps sound
 - The other scan edge channel “b,” 00b to 24b, is automatically selected when continuing to push **[V/M]** (**SKIP•S.MW**) after programming.
- ⑥ To program a frequency for the other pair of scan edges, 00b or 24b, repeat steps ② and ⑤.
 - If the same frequency is programmed into a pair of scan edges, programmed scan will not function.

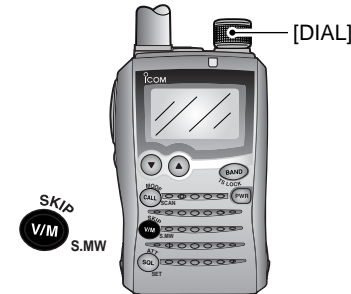

[EXAMPLE]: Programming 145.300 MHz into scan edge 03A.

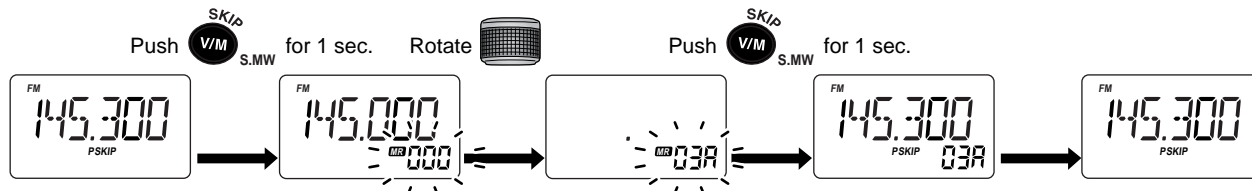

Memory/bank scan

- ① Select *memory mode* with [V/M] (SKIP*S.MW).
- ② Set the squelch to the point where noise is just muted.
- ③ Push and hold [CALL] (MODE*SCAN) for 1 sec. to enter scan type selection mode.
- ④ Rotate [DIAL] to select the desired scanning type.
 - “M ALL” for all memory scan;
 - “B ALL” for all bank scan;
 - “B LINK” for bank link scan;
 - “BANK” for bank scan.



- All memory scan selection

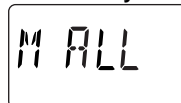

- Bank link scan selection

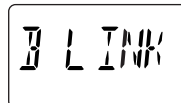

- All bank scan selection



- Bank scan selection

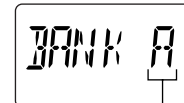

Programmed bank

- ⑤ Push [CALL] (MODE*SCAN) momentarily to start the selected scan.
 - Scan pauses when a signal is received.
 - Rotate [DIAL] to change the scanning direction, or resumes manually.
- ⑥ To stop the scan, push [CALL] (MODE*SCAN).

- During all memory/all bank/ bank link scan

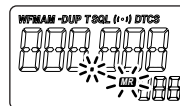

- During bank scan

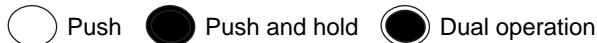
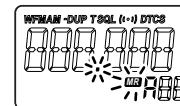

IMPORTANT! To perform memory or bank scan, 2 or more memory/bank channels **MUST** be programmed, otherwise the scan never starts.

■ Auto memory write scan

This scan is useful for searching a specified frequency range and automatically storing busy frequencies into memory channels. The same frequency ranges used for program scan are used for auto memory write scan.

- ① Select *VFO mode* with **[V/M] (SKIP*S.MW)**, if necessary.
- ② Push and hold **[CALL] (MODE*SCAN)** for 1 sec. to enter scan type selection condition.
- ③ Rotate **[DIAL]** to select the desired scanning type.
 - “ALL” for full scan; “BAND” for band scan, “PROGxx” for programmed scan (xx= 0 to 24; programmed scan edges numbers only displayed)
- ④ Push **[CALL] (MODE*SCAN)** to start the scan.
- ⑤ Push **[V/M] (SKIP*S.MW)** to toggle the automatic memory write function ON and OFF.
 - “**MR**” indicator blinks during auto memory write.

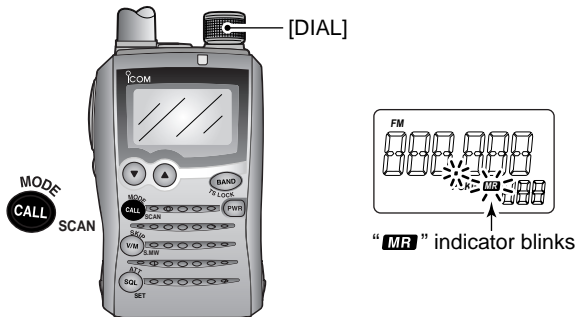

- ⑥ Push **[CALL] (MODE*SCAN)** to stop scan.

◇ During auto-memory write scanning:

- When a signal is received, scan pauses and the frequency is stored into auto memory write channel group (000*–199*).
 - 2 short beeps sound when stored.
- Scan resumes after frequency storing.
- When all channels are stored, the scan cancels automatically and 1 long beep sounds.

◇ Re-calling the stored frequencies:

- ① Push **[V/M] (SKIP*S.MW)** to select *memory mode*.
- ② Push **[BAND] (TS*LOCK)** several times, or while pushing and holding **[BAND] (TS*LOCK)**, rotate **[DIAL]** to select the auto memory write channel group.
 - “**◆**” appears.



- ③ Rotate **[DIAL]** to select the desired channel.

◇ Clearing the stored frequencies:

- ① Select the auto memory write channel group.
- ② While pushing and holding **[FUNC]**, push and hold **[V/M] (SKIP*S.MW)** for 1 sec. to clear the all channels contents.
 - 1 short and 1 long beeps sound.

NOTE: The auto memory write channel contents CANNOT be cleared as an independent channel. Thus it is a good idea to copy the contents into a memory channel.

■ Skip channel/frequency setting

You can set the selected memory channel as a skip channel which is skipped during memory skip scan. In addition, it can be set as a skip channel for both memory skip scan and frequency skip scan. These are useful to speed up the scan interval.

① Select a memory channel:

- ➔ Push **[V/M] (SKIP•S.MW)** to select *memory mode*.
- ➔ Rotate **[DIAL]** to select the desired channel to be a skip channel/frequency.

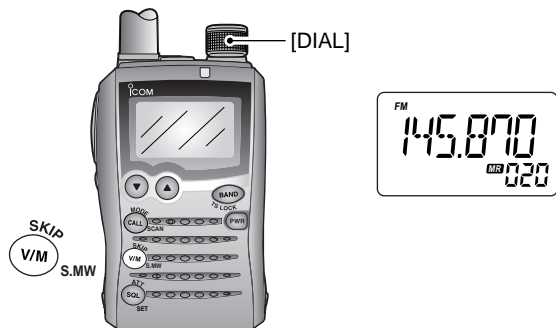

② Push and hold **[V/M] (SKIP•S.MW)** for 1 sec. to enter *select memory write mode*.

- ### ③ Push **[CALL] (MODE•SCAN)** several times to select “SKIP.”
- While pushing and holding **[CALL] (MODE•SCAN)**, rotating **[DIAL]** can also select “SKIP.”

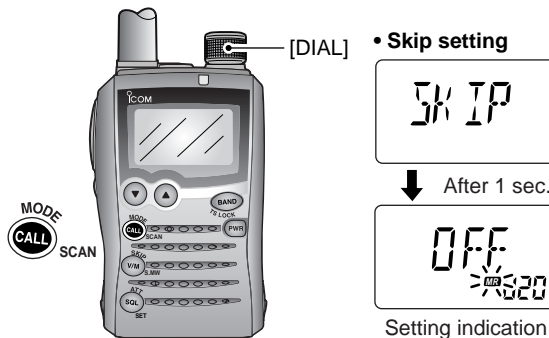

④ Rotate **[DIAL]** to select the skip condition from “SKIP,” “PSKIP” or “OFF” for the selected channel.

- OFF : The channel or programmed frequency is scanned during any scan.
- SKIP : The channel is skipped during memory or bank scan.
- PSKIP : The channel is skipped during memory/bank scan and the programmed frequency is skipped during VFO scan, such as programmed scan.

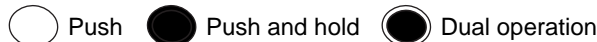

- ⑤ Push **[CALL]** (**MODE•SCAN**) several times; or while pushing and holding **[CALL]** (**MODE•SCAN**), rotate **[DIAL]** to select “S.MW.”
- ⑥ Push and hold **[V/M]** (**SKIP•S.MW**) for 1 sec. to set the skip condition.
 - “SKIP” or “PSKIP” indicator appears, according to the skip selection in step ④.

• Skip channel setting



“SKIP” appears

• Program skip setting



“PSKIP” appears

✓ **CONVENIENT!**

The skip setting can also be easily set with the following operation.

- ① Select the desired memory channel to be set as a skip channel/frequency.
- ② While pushing and holding **[FUNC]**, push **[V/M]** (**SKIP•S.MW**) momentarily to select the skip condition from “SKIP,” “PSKIP” and “OFF (no indication).”

✓ **CONVENIENT!**

During VFO scanning, such as programmed scan, the skip setting can be programmed into the highest blank memory channel which is automatically selected with the following operation.

- ① Start the VFO scan.
 - ➔ Select *VFO mode* with **[V/M]** (**SKIP•S.MW**).
 - Select the desired frequency band with **[BAND]** (**TS•Lock**), if desired.
 - ➔ Push and hold **[CALL]** (**MODE•SCAN**) for 1 sec. to enter scan type selection condition.
 - ➔ Rotate **[DIAL]** to select the desired scanning type.
 - “ALL” for full scan; “BAND” for band scan, “PROGxx” for programmed scan (xx= 0 to 24; programmed scan edges numbers only displayed)
 - ➔ Push **[CALL]** (**MODE•SCAN**) again to start the scan.
 - Scan pauses when a signal is received.
 - Rotate **[DIAL]** to change the scanning direction, or resumes manually.
- ② When scan pauses and you want to set the paused frequency as a skip frequency.
 - ➔ Push and hold **[FUNC]** then push **[V/M]** (**SKIP•S.MW**) for 1 sec. to store the paused frequency into the highest blank memory channel.
 - While pushing and holding **[FUNC]**, scan pauses; and after writing the frequency, scan resumes.

■ Scan resume condition

USING EXPANDED SET MODE

◆ Scan pause timer

The scan pauses when receiving signals according to the scan pause time. It can be set from 2–20 sec. or unlimited.

- ① While pushing and holding **[FUNC]**, push and hold **[SQL] (ATT•SET)** for 1 sec. to enter *set mode*.
- ② Rotate **[DIAL]** to select “EXPAND.”
- ③ While pushing and holding **[FUNC]**, rotate **[DIAL]** to turn the *expanded set mode* ON.
- ④ Rotate **[DIAL]** to select “PAUSE.”
- ⑤ While pushing and holding **[FUNC]**, rotate **[DIAL]** to set the desired scan pausing time from 2–20 sec. (2 sec. steps) or “HOLD.”
 - “2SEC”–“20SEC”; scan pauses 2–20 sec. while receiving a signal.
 - “HOLD”; scan pauses on a received a signal until it disappears.
- ⑥ Push **[SQL] (ATT•SET)** to exit *set mode*.

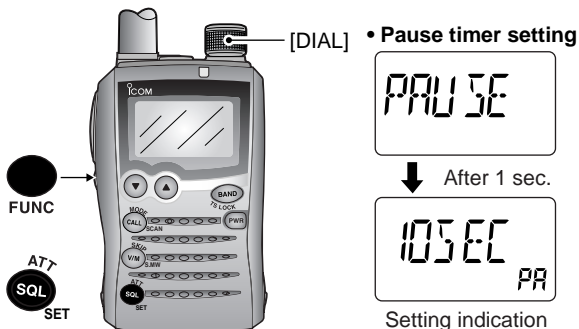

◆ Scan resume timer

The scan re-starts after a signal disappears according to the resume time. It can be set from 0–5 sec. or unlimited.

- ① While pushing and holding **[FUNC]**, push and hold **[SQL] (ATT•SET)** for 1 sec. to enter *set mode*.
- ② Rotate **[DIAL]** to select “EXPAND.”
- ③ While pushing and holding **[FUNC]**, rotate **[DIAL]** to turn the *expanded set mode* ON.
- ④ Rotate **[DIAL]** to select “RESUME.”
- ⑤ While pushing and holding **[FUNC]**, rotate **[DIAL]** to set the desired scan pause time from 0–5 sec. (1 sec. steps) or “HOLD.”
 - “0SEC”; scan restarts immediately after the signal disappears.
 - “1SEC”–“5SEC”; scan restarts 1–5 sec. after the signal disappears.
 - “HOLD”; scan restarts by rotating **[DIAL]** only.
- ⑥ Push **[SQL] (ATT•SET)** to exit *set mode*.

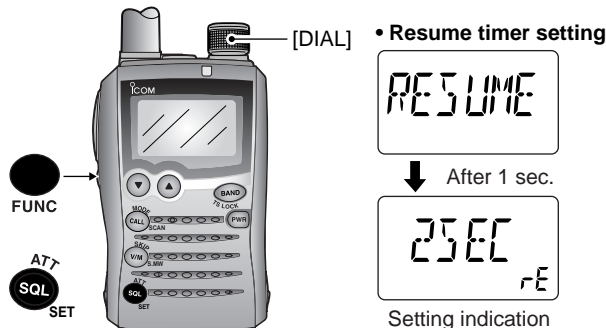

■ Priority watch types

Priority watch checks for signals on a frequency every 5 sec. while operating on a VFO frequency or scanning. The transceiver has 3 priority watch types to suit your needs.

The watch resumes according to the selected scan resume condition. See the page at left for details.

/// NOTES:

/// If the pocket beep function is activated, the transceiver automatically selects the tone squelch function when priority watch starts.

◆ About priority beep function

When receiving a signal on the priority frequency, you can be alerted with beeps and a blinking “((•)).” This function can be activated when setting the priority watch function ON.

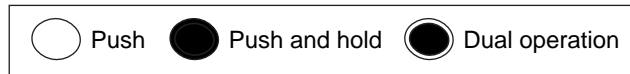

MEMORY CHANNEL WATCH

While operating on a VFO frequency, priority watch checks for a signal on the selected memory channel every 5 sec.

- A memory channel with skip information can be watched.

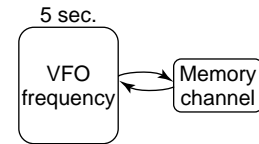

MEMORY SCAN WATCH

While operating on a VFO frequency, priority watch checks for signals on each memory channel in sequence.

- The memory skip function and/or memory bank scan is useful to speed up the scan.

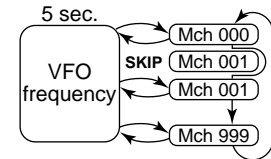

VFO SCAN WATCH

While scanning in *VFO mode*, priority watch checks for signals on the selected memory channel every 5 sec.



Priority watch operation

Memory channel watch and memory scan watch

- ① Select *VFO mode*, then set an operating frequency.
 - TX channel can also be selected.
- ② Push **[V/M] (SKIP•S.MW)** to enter *memory mode*, then select the channel(s) to be watched.

For memory channel watch:
Rotate **[DIAL]** to select the desired memory channel.

For memory scan watch:
Push and hold **[CALL] (MODE•SCAN)** for 1 sec. to enter scan type selection condition to select the scan type, then push **[CALL] (MODE•SCAN)** again to start memory/bank scan.
- ③ While pushing and holding **[FUNC]**, push and hold **[SQL] (ATT•SET)** for 1 sec. to enter *set mode*.
- ④ Rotate **[DIAL]** to select "PRIO."

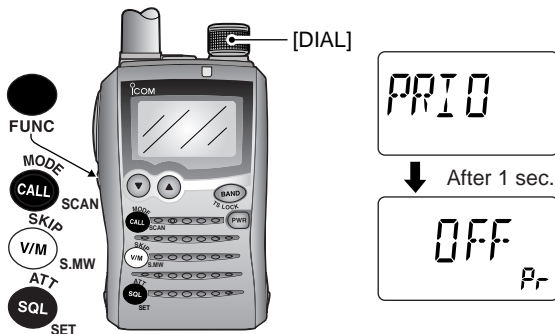

- ⑤ While pushing and holding **[FUNC]**, rotate **[DIAL]** to turn the priority watch ON.
 - Select "BELL" if the priority beep function is necessary.



Priority ON

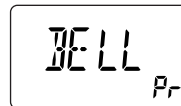

Priority beep ON

- ⑥ Push **[SQL] (ATT•SET)** to exit *set mode* and start the watch.
 - "PRIO" indicator appears.
 - The transceiver checks the memory/bank channel(s) every 5 sec.
 - The watch resumes according to the selected scan resume condition. (p. 41)

• During priority watch



Monitors VFO frequency



Pauses on a memory (bank) channel for 5 sec. when a signal is received.

• During priority watch with priority beep



Emits beep and blinks "(••)" indicator when a signal is received on a memory (bank) channel.



- ⑦ While pushing and holding **[FUNC]**, push **[SQL] (ATT•SET)** to cancel the watch.

◆ VFO scan watch

- ① Push [V/M] (SKIP*S.MW) to enter *memory mode*, then rotate [DIAL] to select the memory channel.
- ② Push and hold [CALL] (MODE*SCAN) for 1 sec. to enter scan type selection condition to select the scan type, then push [CALL] (MODE*SCAN) again to start memory/bank scan, if desired.

/// When scanning memory/bank channels:

/// Starts memory/bank scan first. Memory/bank scan cannot be started after VFO scan is started.

- ③ While pushing and holding [FUNC], push and hold [SQL] (ATT*SET) for 1 sec. to enter *set mode*.
- ④ Rotate [DIAL] to select "PRIO."
- ⑤ While pushing and holding [FUNC], rotate [DIAL] to turn the priority watch ON.
 - Select "BELL" if the priority beep function is necessary.



Priority ON

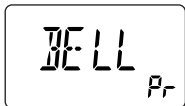

Priority beep ON

- ⑥ Push [SQL] (ATT*SET) to exit *set mode* and start the watch.
 - "PRIO" indicator appears.
- ⑦ Push [CALL] (MODE*SCAN) for 1 sec. to enter scan type selection condition.
- ⑧ Rotate [DIAL] to select the desired scan type from "ALL," "BAND" and "PROGxx (xx= 00–24)."

- ⑨ Push [CALL] (MODE*SCAN) to start the VFO scan watch.
 - The transceiver checks the memory channel(s) every 5 sec.
 - The watch resumes according to the selected scan resume condition. (p. 41)

• During VFO scan watch

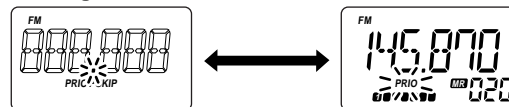

Searches VFO frequencies for 5 sec.

Pauses on a memory (bank) channel when a signal is received.

• During VFO scan watch with priority beep

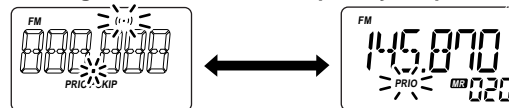

Emits beep and blinks "(*)" indicator when a signal is received on a memory (bank) channel.

- ⑩ While pushing and holding [FUNC], push [SQL] (ATT*SET) to cancel the watch and scan.

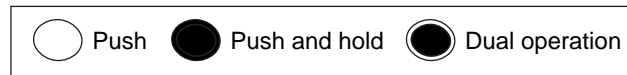

■ Tone/DTCS squelch operation

The tone or DTCS squelch opens only when receiving a signal with the same pre-programmed subaudible tone or DTCS code, respectively. You can silently wait for a signal using the same specified tone.

- ① Set the desired frequency in FM mode.
- ② While pushing and holding **[FUNC]**, push and hold **[SQL]** (**ATT•SET**) for 1 sec. to enter *set mode*.
- ③ Rotate **[DIAL]** to select “T/TSQL.”
- ④ While pushing and holding **[FUNC]**, rotate **[DIAL]** to select the desired tone squelch condition from “TSQL,” “P BEEP,” “DTCS” and “P DTCS.”



Subaudible tone OFF



Tone squelch selection



DTCS selection

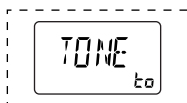

Repeater tone selection

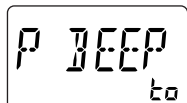

Tone squelch with pocket beep function selection

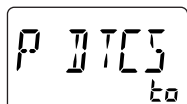

DTCS with pocket beep function selection

- ⑤ Push **[SQL]** (**ATT•SET**) to exit *set mode*.
 - One of “TSQL,” “TSQL ((•)),” “DTCS” or “((•)) DTCS” appears according to the tone selection in the step ④.

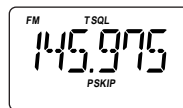

Tone squelch selection

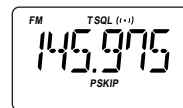

Tone squelch with pocket beep function selection

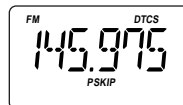

DTCS selection

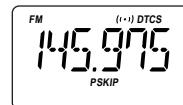

DTCS with pocket beep function selection

- ⑥ When a signal with a matching tone is received, the squelch opens and the transceiver emits audio. When pocket beep function is activated, the transceiver also emits beep tones and blinks “((•)).”
 - Beep tones sound and “((•))” blinks for 30 sec.
- ⑦ Push **[FUNC]** to manually stop the beeps and blinking.
 - “((•))” disappears and the pocket beep function is deactivated.
- ⑧ To cancel the tone squelch or DTCS, select “OFF” with the “T/TSQL” in the *set mode*, as described in step ④.

■ Tone squelch frequency/DTCS code setting

88.5 Hz and 023 is set as the default for the tone squelch frequency and the DTCS code, respectively. The frequency and code can be selected as desired.

- ① While pushing and holding **[FUNC]**, push and hold **[SQL] (ATT*SET)** for 1 sec. to enter *set mode*.
- ② Rotate **[DIAL]** to select “C TONE” when selecting the tone squelch frequency; select “CODE” when selecting the DTCS code.

Tone squelch frequency selection



DTCS code selection



- ③ While pushing and holding **[FUNC]**, rotate **[DIAL]** to select the desired subaudible tone frequency or DTCS code.
 - See the tables at right.
- ④ Push **[SQL] (ATT*SET)** to exit *set mode*.

• Available tone frequency

67.0	79.7	94.8	110.9	131.8	156.7	171.3	186.2	203.5	229.1
69.3	82.5	97.4	114.8	136.5	159.8	173.8	189.9	206.5	233.6
71.9	85.4	100.0	118.8	141.3	162.2	177.3	192.8	210.7	241.8
74.4	88.5	103.5	123.0	146.2	165.5	179.9	196.6	218.1	250.3
77.0	91.5	107.2	127.3	151.4	167.9	183.5	199.5	225.7	254.1

NOTE: The transceiver has 50 tone frequencies and consequently their spacing are narrow compared to units having 38 tones. Therefore, some tone frequencies may receive interference from adjacent tone frequencies.

• Available DTCS code

023	054	125	165	245	274	356	445	506	627	732
025	065	131	172	246	306	364	446	516	631	734
026	071	132	174	251	311	365	452	523	632	743
031	072	134	205	252	315	371	454	526	654	754
032	073	143	212	255	325	411	455	532	662	
036	074	145	223	261	331	412	462	546	664	
043	114	152	225	263	332	413	464	565	703	
047	115	155	226	265	343	423	465	606	712	
051	116	156	243	266	346	431	466	612	723	
053	122	162	244	271	351	432	503	624	731	

DTCS polarity setting

As well as a code setting, the polarity setting is also available for the DTCS operation. When a different polarity is set, the DTCS never releases audio mute even when a signal with a matching code number is received.

- ① While pushing and holding **[FUNC]**, push and hold **[SQL]** (**ATT•SET**) for 1 sec. to enter *set mode*.
- ② Rotate **[DIAL]** to select “EXPAND.”
- ③ While pushing and holding **[FUNC]**, rotate **[DIAL]** to turn the *expanded set mode* ON.
- ④ Rotate **[DIAL]** to select “DTCS P.”

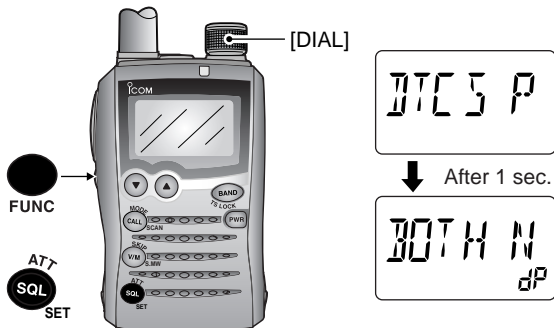

- ⑤ While pushing and holding **[FUNC]**, rotate **[DIAL]** to select the polarity from “BOTH N” (normal), “TN-RR” (TX: normal, RX: reverse), “TR-RN” (TX: reverse, RX: normal) and “BOTH R” (reverse).



TX/RX: Normal polarity

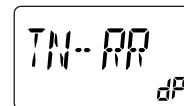

TX: Normal, RX: Reverse

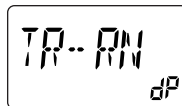

TX: Reverse, RX: Normal



TX/RX: Reverse polarity

- ⑥ Push **[SQL]** (**ATT•SET**) to exit *set mode*.

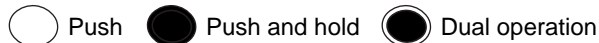

■ Tone scan

By monitoring a signal that is being operated with pocket beep, tone or DTCS squelch function, you can determine the tone frequency or DTCS code necessary to open a squelch.

- ① Set the frequency to be checked for a tone frequency or code.
- ② Turn the desired tone type ON in *set mode*; “TONE” (repeater tone), “TSQL” (tone squelch) or “DTCS” (DTCS squelch).
 - One of “T,” “TSQL” or “DTCS” appears.
 - Even if the pocket beep function is activated, it is cancelled when the tone scan is started.
- ③ While pushing and holding [FUNC], push [CALL] (MODE*SCAN) for 1 sec. to start the tone scan.
 - To change the scanning direction, rotate [DIAL].



Repeater tone scan

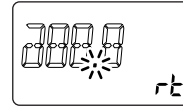

Tone squelch scan

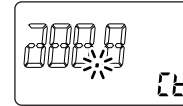

DTCS scan

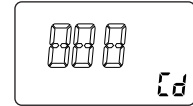

- ④ When the CTCSS tone frequency or 3-digit DTCS code is matched, the squelch opens and the tone frequency or code is temporarily programmed into the selected condition, such as a memory channel.
 - The tone scan pauses when a CTCSS tone frequency or 3-digit DTCS code is detected.

NOTE: The decoded tone frequency or code is programmed temporarily when a memory channel is selected. However, this will be cleared when the memory channel is re-selected.

✓ CONVENIENT!

Even if no tone type is selected, pushing and holding [CALL] (MODE*SCAN) for 1 sec. while pushing and holding [FUNC] also starts tone scan. In this case, the tone scan searches for repeater tone frequency only.

10 SET MODE

■ General

Set mode is used for programming infrequently changed values or conditions of functions.

In addition, the IC-E7 has an *expanded set mode* which is used for programming even more infrequently changed values or conditions of functions. When turning the *expanded set mode* OFF, only half of the set mode items are displayed for simple operation.

◇ Set mode entering and operation

- ① While pushing and holding **[FUNC]**, push and hold **[SQL]** (**ATT•SET**) for 1 sec. to enter *set mode*.
- ② Rotate **[DIAL]** to select the desired item.
- ③ While pushing and holding **[FUNC]**, rotate **[DIAL]** to select the desired value or condition.
- ④ Push **[SQL]** (**ATT•SET**) to exit *set mode*, or rotate **[DIAL]** to select another set mode item.

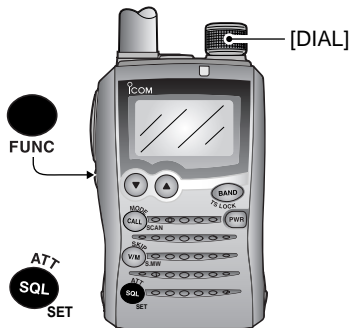

◇ Expanded set mode ON/OFF

- ① While pushing and holding **[FUNC]**, push and hold **[SQL]** (**ATT•SET**) for 1 sec. to enter *set mode*.
- ② Rotate **[DIAL]** to select "EXPAND."



- ③ While pushing and holding **[FUNC]**, rotate **[DIAL]** to turn the *expanded set mode* ON and OFF.



Expanded set mode OFF

Expanded set mode ON

- ④ Rotate **[DIAL]** to select the desired item.
- ⑤ While pushing and holding **[FUNC]**, rotate **[DIAL]** to select the desired value or condition.
- ⑥ Push **[SQL]** (**ATT•SET**) to exit *set mode*, or rotate **[DIAL]** to select another item.

○ Push ● Push and hold ● Dual operation

■ Set mode items

The following items are available in the *set mode* and *expanded set mode*.

◇ General set mode items

- Repeater tone (p. 52)

R TONE

- Tone squelch tone (p. 52)

C TONE

- DTCS code (p. 52)

CODE

- Dial select step (p. 53)

D SEL

- Offset frequency (p. 53)

OFF SET

- Tone selection (p. 53)

T/T SOL

- Duplex direction (p. 54)

DUP

- Priority watch (p. 54)

PRIO

- Key-touch beep (p. 54)

BEEP

- Beep output level (p. 54)

BEEPLV

- Display backlighting (p. 55)

LIGHT

- Power save (p. 55)

P SAVE

- Expanded set mode (p. 49)

EXPAND

10 SET MODE

◇ Expanded set mode items

- Key lock effect (p. 56)

LOCK

- Dial speed acceleration (p. 56)

SPEED

- Monitor key action (p. 56)

MONI

- Auto power OFF (p. 57)

AP OFF

- Scan pause timer (p. 57)

PAUSE

- Scan resume timer (p. 57)

RESUME

- Scan stop beep (p. 57)

STOP B

- DTCS polarity (p. 58)

DTCS P

- Bank link (p. 58)

B LINK

- LCD contrast (p. 59)

CONT

◆ Repeater tone frequency

Selects subaudible tone frequency for accessing a repeater, etc. Total of 50 tone frequencies (67.0–254.1 Hz) are available.

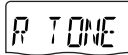

(default: 88.5 Hz)



88.5 Hz setting

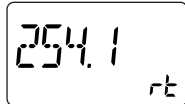

254.1 Hz setting

◆ Tone squelch frequency

Selects tone frequency for tone squelch or pocket beep operation from one of 50 available frequencies (67.0–254.1 Hz).

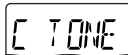

(default: 88.5 Hz)



88.5 Hz setting

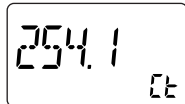

254.1 Hz setting

• Available subaudible tone frequencies

67.0	79.7	94.8	110.9	131.8	156.7	171.3	186.2	203.5	229.1
69.3	82.5	97.4	114.8	136.5	159.8	173.8	189.9	206.5	233.6
71.9	85.4	100.0	118.8	141.3	162.2	177.3	192.8	210.7	241.8
74.4	88.5	103.5	123.0	146.2	165.5	179.9	196.6	218.1	250.3
77.0	91.5	107.2	127.3	151.4	167.9	183.5	199.5	225.7	254.1

◆ DTCS code

Selects DTCS (both encoder/decoder) code for DTCS squelch operation. Total of 104 codes (023–754) are available.



(default: 023)



Code 023 setting

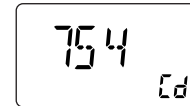

Code 754 setting

• Available DTCS code

023	054	125	165	245	274	356	445	506	627	732
025	065	131	172	246	306	364	446	516	631	734
026	071	132	174	251	311	365	452	523	632	743
031	072	134	205	252	315	371	454	526	654	754
032	073	143	212	255	325	411	455	532	662	
036	074	145	223	261	331	412	462	546	664	
043	114	152	225	263	332	413	464	565	703	
047	115	155	226	265	343	423	465	606	712	
051	116	156	243	266	346	431	466	612	723	
053	122	162	244	271	351	432	503	624	731	

/// The polarity can also be set in “DTCS P” as described on page 58.

10 SET MODE

◆ Dial select step

Select the tuning step while pushing and holding **[FUNC]** from 100 kHz, 1 MHz (default) and 10 MHz.

1 MHz step

100 kHz step

◆ Offset frequency

Sets the offset frequency for duplex (repeater) operation for each frequency band independently within 0 to 159.995 MHz range. During duplex operation (–DUP or +DUP), the offset frequency shifts the transmit frequency (or while **[SQL]** (**ATT•SET**) is pushed).

The default value may differ according to the selected frequency band (before accessing *set mode*) and transceiver version.

▨ The selected tuning step in *VFO mode* is used for setting the offset frequency.

◆ Tone selection

Sets the tone encoder, tone squelch or DTCS squelch operation and pocket beep capability, when waiting for the desired signal.

- OFF : Regular noise squelch operation. (default)
- TONE : Using tone encoder. Some repeaters require subaudible tones to be accessed.
- TSQL : Using tone squelch. The squelch opens only when a signal with matched subaudible tone is received.
- P BEEP : In addition to the “TSQL” setting, alert beeps will sound when a signal with matched tone is received.
- DTCS : Using DTCS squelch. The squelch opens only when a signal with matched DTCS code is received.
- P DTCS : In addition to the “DTCS” setting, alert beeps will sound when a signal with matched DTCS code is received.

Tone squelch operation

DTCS squelch operation

▨ The subaudible tone frequency and DTCS code are programmed as the tone frequency and DTCS code items, respectively.

◇ Duplex direction

Sets the duplex direction. The transmit frequency is shifted from the receive frequency by the offset frequency when transmitting or when the monitor function is in use.

- OFF : Simplex operation. (default)
- -DUP : The transmit frequency shifts down while transmitting.
- +DUP : The transmit frequency shifts up while transmitting.



Simplex operation



Positive duplex operation



◇ Priority watch

Turn the priority watch or priority beep (priority watch with beep capability) ON. (default: OFF)

- ON : Start priority watch after exiting *set mode*.
- BELL : Emits beeps and blinking “(••)” indicator when a signal is received on the priority frequency.



Priority watch OFF

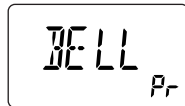

Priority beep ON

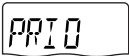

◇ Key-touch beep

The key-touch beep can be turned OFF for silent operation.



(default: ON)



Key-touch beep ON



Key-touch beep OFF

◇ Beep output level

Adjust the key-touch beep tone level to the desired level within 8 levels.

Beep tone sounds while setting. The tone sound let you know the approximate sound level.

(default: 2)



Default level



Maximum level



▨ The key-touch beep (previous item) must be set to ON to have a beep tone.

10 SET MODE

◆ Display backlighting

The transceiver has display backlighting with a 5 sec. timer for night time operation. The backlighting can be turned ON continuously or turned OFF, if desired.

- AUTO: Lights when an operation is performed, goes out after 5 sec. (default)
- ON : Lights continuously during transceiver power is ON.
- OFF : Never lights.

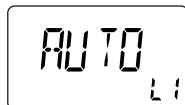
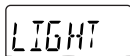

Auto setting



Continuously ON setting

◆ Power save

The power save function reduces the current drain to conserve battery power. This power save function can be turned OFF, if desired.

In the default setting (“ON” selection), the power save function is activated in 1:4 (125 msec.: 500 msec.) ratio when no signal is received for 5 sec. The ratio becomes 1:8 (125 msec.: 1 sec.) when no signal is received for another 60 sec.

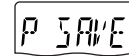

Power save ON

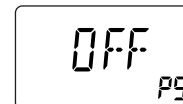

Power save OFF

◇ Key lock effect

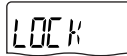

While the key lock function is ON, [▲]/[▼] and [SQL] (ATT•SET) can still be accessed. Accessible keys can be set to one of 4 groups.

[PWR] and [FUNC]+[BAND] (TS•Lock) are also accessible during the lock, however, these keys are not effected by this setting.

- NORMAL : [▲]/[▼] and [SQL] (ATT•SET) are accessible. (default)
- NO SQL : [SQL] (ATT•SET) is accessible.
- NO VOL : [▲]/[▼] are accessible.
- ALL : No accessible key is available, except [PWR] and [FUNC]+[BAND] (TS•Lock).



Normal lock condition

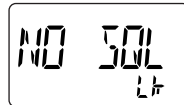

Squelch level can be adjusted



Audio output can be adjusted

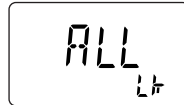

Transceiver power and lock function only switchable

◇ Dial speed acceleration



The dial speed acceleration automatically speeds up the tuning dial speed when rotating [DIAL] rapidly.

- ON : The dial speed acceleration is tuned ON. (default)
- OFF : The dial speed acceleration is turned OFF.



The acceleration ON

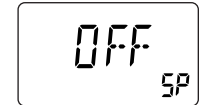

The acceleration OFF

◇ Monitor key action

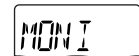

The monitor key, [SQL] (ATT•SET), can be set as a 'sticky' key. When set to the sticky condition, each push of [SQL] (ATT•SET) toggles the monitor function ON and OFF.

- PUSH : Pushing and holding [SQL] (ATT•SET) to monitor the frequency. (default)
- HOLD : Push [SQL] (ATT•SET) momentarily to monitor the frequency and push momentarily again to cancel it.

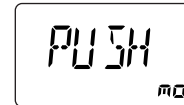

Monitor key activates as PUSH function key.

Push and hold [SQL] to monitor

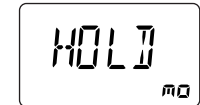

Monitor key activates as HOLD function key.

Push to monitor

10 SET MODE

◆ Auto power OFF

The transceiver can be set to automatically turn OFF after a specified period with a beep when no key operations are performed.

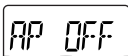
A rectangular display box containing the text "AP OFF" in a digital font.

30 min., 1 hour, 1.5 hours, 2 hours and OFF (default) can be specified. The specified period is retained even when the transceiver is turned OFF by the auto power OFF function. To cancel the function, select "OFF" in this *set mode*.

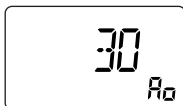
A rectangular display box containing the number "30" and the label "Aa" below it.

30 min. timer

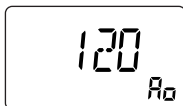
A rectangular display box containing the number "120" and the label "Aa" below it.

2 hrs. timer

◆ Scan pause timer

Selects the scan pause time. When receiving signals, the scan pauses according to the scan pause time.

- 2–20 : Scan pauses for 2–20 sec. on a received signal, and is selected in 2 sec. steps. (default: 10 sec.)
- HOLD: Scan pauses on a received signal until it disappears. Rotate [DIAL] to resume manually.

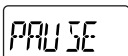
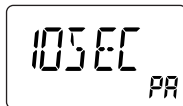
A rectangular display box containing the text "PAUSE" in a digital font.A rectangular display box containing the text "10SEC" and the label "PA" below it.

Scan pauses for 10 sec.

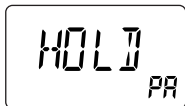
A rectangular display box containing the text "HOLD" and the label "PA" below it.

Scan pauses until signal disappears

◆ Scan resume timer

Selects scan resume time. Scan resumes after the specified period when the received signal disappears.

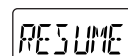
A rectangular display box containing the text "RESUME" in a digital font.

- 0 : Scan resumes immediately when the received signal disappears.
- 1–5 : Scan pause 1–5 sec. after the received signal disappears. (default: 2 sec.)
- HOLD: Scan pauses on the received signal even if it disappears. Rotate [DIAL] to resume manually.

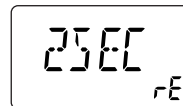
A rectangular display box containing the text "2SEC" and the label "rE" below it.

Scan resumes after 2 sec.

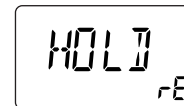
A rectangular display box containing the text "HOLD" and the label "rE" below it.

Scan resumes manually

◆ Scan stop beep

Turns the scan stop beep function ON and OFF (default).

When the function is activated ("ON" is selected), a long beep will sound each time a signal is received during scan.

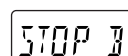
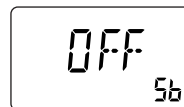
A rectangular display box containing the text "STOP B" in a digital font.A rectangular display box containing the text "OFF" and the label "Sb" below it.

No beep is sound when receiving a signal

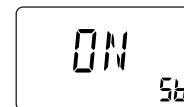
A rectangular display box containing the text "ON" and the label "Sb" below it.

A long beep is sound when receiving a signal

◇ DTCS polarity

Sets DTCS polarity from “BOTH N” (TX/RX: normal), “TN-RR” (TX: normal, RX: reverse), “TR-RN” (TX: reverse, RX: normal) and “BOTH R” (TX/RX: reverse).

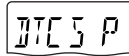

(default: BOTH N)



TX/RX: Normal polarity



TX: Normal, RX: Reverse



TX: Reverse, RX: Normal

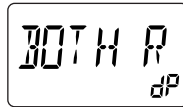

TX/RX: Reverse polarity

◇ Memory bank link function

Sets the memory bank link function ON (default) and OFF. The link function provides continuous bank scan, scanning all contents in the selected banks during bank scan.



• Bank link setting

- ① While pushing and holding [FUNC], rotate [DIAL] to select the desired bank to be linked.
 - “A-ON” to “y-ON” appears.
 - A to H, J, L, N, O to R, T, U and y are available for usage by group
- ② Push [CALL] (MODE•SCAN) to select “ON” to link the bank.

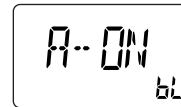

Bank A is linked

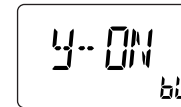

Bank Y is linked

- ③ Repeat steps ① and ② to link other banks.
 - To cancel the memory bank link function, repeat steps ① and ② to select “OFF.”

10 SET MODE

◆ LCD contrast

Sets the LCD contrast within 1 to 4 levels as desired.



(default: 3)

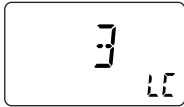

Contrast 3 setting

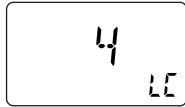

Contrast 4 setting

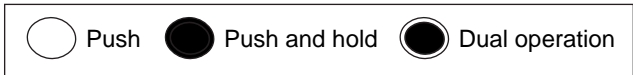

■ Data cloning

Cloning allows you to quickly and easily transfer the programmed contents from one transceiver to another; or data from a personal computer to a transceiver using the optional CS-P7 CLONING SOFTWARE.

◇ Cloning between transceivers

① Master transceiver:

While pushing and holding **[CALL]** (**MODE*SCAN**), turn power ON to enter cloning mode.

- The master transceiver is used to send data to the sub-transceiver.

Sub-transceiver:

While pushing and holding **[V/M]** (**SKIP*S.MW**), turn power ON to enter cloning mode.

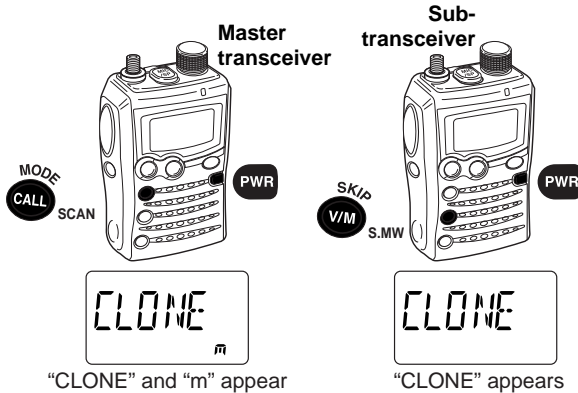

AT POWER ON

- ② Connect the OPC-474 cloning cable to the [MIC/SP] jack of the master and sub-transceivers.

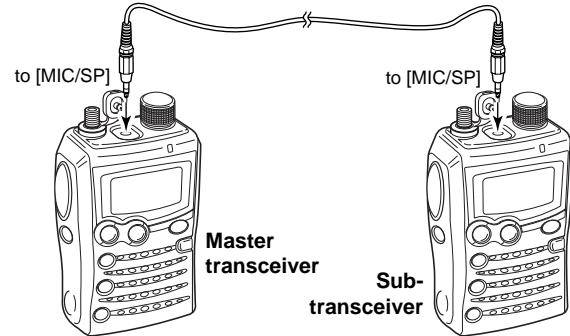

- ③ Push **[SQL]** (**ATT*SET**) on the master transceiver.
- The transceiver show following indications.

Master transceiver indications



Sub-transceiver indications

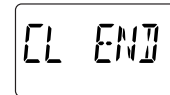
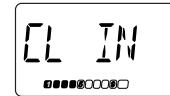

- ④ When cloning is finished, turn power OFF, then ON to exit cloning mode.

11 OTHER FUNCTIONS

◇ Cloning using a personal computer

Data can be cloned to and from a personal computer (Microsoft® Windows® 98/98SE/Me/2000/XP) using the optional CS-P7 CLONING SOFTWARE and the optional OPC-478/478U CLONING CABLE. Consult the CS-P7 CLONING SOFTWARE HELP file for details.

CAUTION: Be sure to turn OFF the transceiver when connecting the cloning cable, otherwise cloning operations cannot be performed.

◇ Cloning error

NOTE: DO NOT push any key on the sub-transceiver during cloning. This will cause a cloning error.

When the display appears as below, a cloning error has occurred.

In such a case, both transceivers automatically return to the clone standby condition and cloning must be repeated.

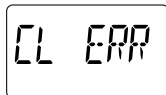

Microsoft and Windows are registered trademarks of Microsoft Corporation in the U.S.A. and other countries.

■ Auto power-off function

USING EXPANDED SET MODE

The IC-E7 can be set to automatically turn OFF after a specified period in which no operation is performed.

120 min., 90 min., 60 min., 30 min. and OFF can be specified. The specified period is retained even when the transceiver is turned OFF by the auto power-off function. To cancel the function, select "OFF" in step ③ below.

- ① While pushing and holding **[FUNC]**, push and hold **[SQL] (ATT•SET)** for 1 sec. to enter *set mode*.
- ② Rotate **[DIAL]** to select "AP OFF."
 - Turn the *expanded set mode* ON for selection. (p. 39)

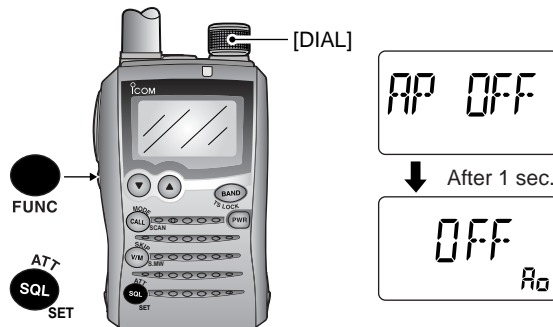

- ③ While pushing and holding **[FUNC]**, rotate **[DIAL]** to select the desired time or to turn the function OFF.
- ④ Push **[SQL] (ATT•SET)** to exit *set mode*.

■ TV channel operation

TV channel operation is available only when TV channels are programmed using the optional CS-P7 CLONING SOFTWARE. (p. 61)

◇ TV channel receiving

- ① Push **[V/M]** (**SKIP•S.MW**) to select *VFO mode*, if necessary.
- ② Push **[BAND]** (**TS•LOCK**) several times to select the TV channel band.
 - “TV” and channel number appear.
 - While pushing and holding **[BAND]** (**TS•LOCK**), rotating **[DIAL]** also selects the TV channel band.
- ③ Rotate **[DIAL]** to select the desired channel.
 - While pushing and holding **[FUNC]**, rotating **[DIAL]** selects the all channels including skip channel.

◇ Skip channel setting

Unwanted channels can be skipped for rapid selection, etc.

- ① Rotate **[DIAL]** to select the channel to be skipped.
 - To clear the skip setting, rotate **[DIAL]** while pushing and holding **[FUNC]** to select a skip channel.
- ② While pushing and holding **[FUNC]**, push **[V/M]** (**SKIP•S.MW**) to toggle the skip setting ON and OFF.
 - “SKIP” appears when the channel is set as skip channel.

◇ Automatic TV channel programming

TV channels can be programmed automatically.

- ➡ Push and hold **[CALL]** (**MODE•SCAN**) for 1 sec. to start TV channel programming.
 - The programming will automatically stop when scanning all channels.

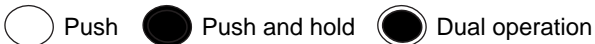

11 OTHER FUNCTIONS

■ All reset

The function display may occasionally display erroneous information (e.g. when first applying power). This may be caused externally by static electricity or by other factors.

If this problem occurs, turn power OFF. After waiting a few seconds, turn power ON again. If the problem persists, perform the following procedure.

• Partial resetting is also available. See next page for details.

/// IMPORTANT!:

Resetting the transceiver **CLEAR**s all memory information and initializes all values in the transceiver, including TV channel skip setting.

➔ While pushing and holding **[FUNC]**, **[V/M]** (**SKIP•S.MW**) and **[SQL]** (**ATT•SET**), turn the power ON to reset the CPU.

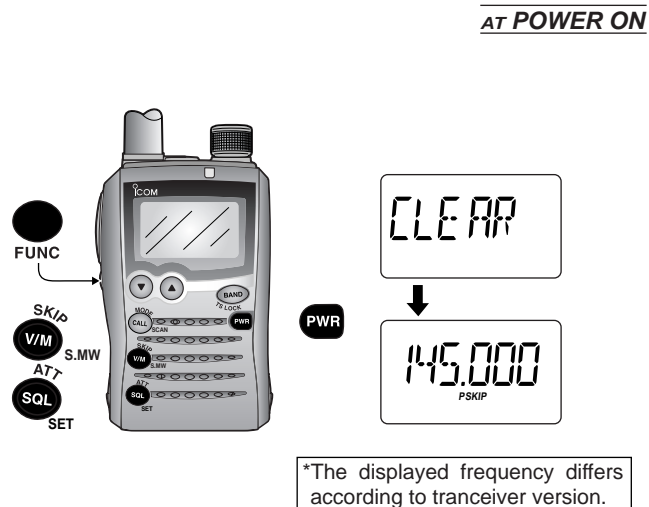

■ Partial reset

AT POWER ON

If you want to initialize the operating conditions (VFO frequency, VFO settings, set mode contents) without clearing the memory contents, a partial reset function is available for the transceiver.

- ➔ While pushing and holding **[FUNC]** and **[V/M] (SKIP*S.MW)**, turn the power ON to partially reset the transceiver.



○ Push ● Push and hold ◐ Dual operation

12 FREQUENCY TABLE

■ TV channels

The following tables show the channels versus video and audio frequencies depending on each version.

◇ U.S.A. channels

(unit: MHz)

CH	Freq.	CH	Freq.	CH	Freq.
2	59.75	27	553.75	52	703.75
3	65.75	28	559.75	53	709.75
4	71.75	29	565.75	54	715.75
5	81.75	30	571.75	55	721.75
6	87.75	31	577.75	56	727.75
7	179.75	32	583.75	57	733.75
8	185.75	33	589.75	58	739.75
9	191.75	34	595.75	59	745.75
10	197.75	35	601.75	60	751.75
11	203.75	36	607.75	61	757.75
12	209.75	37	613.75	62	763.75
13	215.75	38	619.75	63	769.75
14	475.75	39	625.75	64	775.75
15	481.75	40	631.75	65	781.75
16	487.75	41	637.75	66	787.75
17	493.75	42	643.75	67	793.75
18	499.75	43	649.75	68	799.75
19	505.75	44	655.75	69	805.75
20	511.75	45	661.75		
21	517.75	46	667.75		
22	523.75	47	673.75		
23	529.75	48	679.75		
24	535.75	49	685.75		
25	541.75	50	691.75		
26	547.75	51	697.75		

◇ CCIR channels (unit: MHz)

CH	Freq.	CH	Freq.
1	46.75	40	628.75
2	53.75	41	636.75
3	60.75	42	644.75
4	67.75	43	652.75
5	180.75	44	660.75
6	187.75	45	668.75
7	194.75	46	676.75
8	201.75	47	684.75
9	208.75	48	692.75
10	215.75	49	700.75
11	222.75	50	708.75
12	229.75	51	716.75
21	476.75	52	724.75
22	484.75	53	732.75
23	492.75	54	740.75
24	500.75	55	748.75
25	508.75	56	756.75
26	516.75	57	764.75
27	524.75	58	772.75
28	532.75	59	780.75
29	540.75	60	788.75
30	548.75	61	796.75
31	556.75	62	804.75
32	564.75	63	812.75
33	572.75	64	820.75
34	580.75	65	828.75
35	588.75	66	836.75
36	596.75	67	844.75
37	604.75	68	852.75
38	612.75	69	860.75
39	620.75		

◇ Australian channels

(unit: MHz)

CH	Freq.	CH	Freq.
0	51.75	43	637.75
1	62.75	44	644.75
2	69.75	45	651.75
3	91.75	46	658.75
4	100.75	47	665.75
5	107.75	48	672.75
5A	143.75	49	679.75
6	180.75	50	686.75
7	187.75	51	693.75
8	194.75	52	700.75
9	201.75	53	707.75
10	214.75	54	714.75
11	221.75	55	721.75
28	532.75	56	728.75
29	539.75	57	735.75
30	546.75	58	742.75
31	553.75	59	749.75
32	560.75	60	756.75
33	567.75	61	763.75
34	574.75	62	770.75
35	581.75	63	777.75
36	588.75	64	784.75
37	595.75	65	791.75
38	602.75	66	798.75
39	609.75	67	805.75
40	616.75	68	812.75
41	623.75	69	819.75
42	630.75		

◇ China channels

CH	Freq.	CH	Freq.
1	56.25	32	669.75
2	64.25	33	677.75
3	72.25	34	685.75
4	83.75	35	693.75
5	91.75	36	701.75
6	174.75	37	709.75
7	182.75	38	717.75
8	190.75	39	725.75
9	198.75	40	733.75
10	206.75	41	741.75
11	214.75	42	749.75
12	222.75	43	757.75
13	477.75	44	765.75
14	485.75	45	773.75
15	493.75	46	781.75
16	501.75	47	789.75
17	509.75	48	797.75
18	517.75	49	805.75
19	525.75	50	813.75
20	533.75	51	821.75
21	541.75	52	829.75
22	549.75	53	837.75
23	557.75	54	845.75
24	565.75	55	853.75
25	613.75	56	861.75
26	621.75	57	869.75
27	629.75	58	877.75
28	637.75	59	885.75
29	645.75	60	893.75
30	653.75	61	901.75
31	661.75	62	909.75

(unit: MHz)

CH	Freq.
63	917.75
64	925.75
65	933.75
66	941.75
67	949.75
68	957.75

◇ New Zealand channels
(unit: MHz)

CH	Freq.
1	50.75
2	60.75
3	67.75
4	180.75
5	187.75
6	194.75
7	201.75
8	208.75
9	215.75
10	222.75
11	229.75

◇ UK channels

(unit: MHz)

CH	Freq.
21	477.25
22	485.25
23	493.25
24	501.25
25	509.25
26	517.25
27	525.25
28	533.25
29	541.25
30	549.25
31	557.25
32	565.25
33	573.25
34	581.25
35	589.25
36	597.25
37	605.25
38	613.25
39	621.25
40	629.25
41	637.25
42	645.25
43	653.25
44	661.25
45	669.25
46	677.25
47	685.25
48	693.25
49	701.25
50	709.25
51	717.25

◇ French channels (unit: MHz)

CH	Freq.
52	725.25
53	733.25
54	741.25
55	749.25
56	757.25
57	765.25
58	773.25
59	781.25
60	789.25
61	797.25
62	805.25
63	813.25
64	821.25
65	829.25
66	837.25
67	845.25
68	853.25
69	861.25

CH	Freq.
2	49.25
3	54.00
4	57.25
5	182.50
6	190.50
7	198.50
8	206.50
9	214.50
10	222.50
21	477.75
22	485.75
23	493.75
24	501.75
25	509.75
26	517.75
27	525.75
28	533.75
29	541.75
30	549.75
31	557.75
32	565.75
33	573.75
34	581.75
35	589.75
36	597.75
37	605.75
38	613.75
39	621.75
40	629.75
41	637.75
42	645.75

CH	Freq.
43	653.75
44	661.75
45	669.75
46	677.75
47	685.75
48	693.75
49	701.75
50	709.75
51	717.75
52	725.75
53	733.75
54	741.75
55	749.75
56	757.75
57	765.75
58	773.75
59	781.75
60	789.75
61	797.75
62	805.75
63	813.75
64	821.75
65	829.75
66	837.75
67	845.75
68	853.75
69	861.75

12 FREQUENCY TABLE

◆ Indonesian channels

(unit: MHz)

CH	Freq.	CH	Freq.
2	53.75	40	628.75
3	60.75	41	636.75
4	67.75	42	644.75
5	180.75	43	652.75
6	187.75	44	660.75
7	194.75	45	668.75
8	201.75	46	676.75
9	208.75	47	684.75
10	215.75	48	692.75
11	222.75	49	700.75
12	229.75	50	708.75
21	476.75	51	716.75
22	484.75	52	724.75
23	492.75	53	732.75
24	500.75	54	740.75
25	508.75	55	748.75
26	516.75	56	756.75
27	524.75	57	764.75
28	532.75	58	772.75
29	540.75	59	780.75
30	548.75	60	788.75
31	556.75	61	796.75
32	564.75	62	804.75
33	572.75	63	812.75
34	580.75	64	820.75
35	588.75	65	828.75
36	596.75	66	836.75
37	604.75	67	844.75
38	612.75	68	852.75
39	620.75	69	860.75

◆ Italian channels (unit: MHz)

CH	Freq.	CH	Freq.
A	59.25	42	644.75
B	67.75	43	652.75
C	87.75	44	660.75
D	180.75	45	668.75
E	188.75	46	676.75
F	197.75	47	684.75
G	206.75	48	692.75
H	215.75	49	700.75
H1	222.75	50	708.75
H2	229.75	51	716.75
21	476.75	52	724.75
22	484.75	53	732.75
23	492.75	54	740.75
24	500.75	55	748.75
25	508.75	56	756.75
26	516.75	57	764.75
27	524.75	58	772.75
28	532.75	59	780.75
29	540.75	60	788.75
30	548.75	61	796.75
31	556.75	62	804.75
32	564.75	63	812.75
33	572.75	64	820.75
34	580.75	65	828.75
35	588.75	66	836.75
36	596.75	67	844.75
37	604.75	68	852.75
38	612.75	69	860.75
39	620.75		
40	628.75		
41	636.75		

◆ Taiwan channels

(unit: MHz)

CH	Freq.
7	179.75
8	185.75
9	191.75
10	197.75
11	203.75
12	209.75

◆ FOT channels

(unit: MHz)

CH	Freq.
4	181.75
5	189.75
6	197.75
7	205.75
8	213.75
9	221.75

■ VHF marine channels

(unit: MHz)

CH No.	Ship Transmit	Ship Receive	CH No.	Ship Transmit	Ship Receive
01	156.050	160.650	21A	157.050	157.050
01A	156.050	156.050	21b	161.650	161.650
02	156.100	160.700	22	157.100	161.700
03	156.150	160.750	22A	157.100	157.100
03A	156.150	156.150	23	157.150	161.750
04	156.200	160.800	23A	157.150	157.150
04A	156.200	156.200	24	157.200	161.800
05	156.250	160.850	25	157.250	161.850
05A	156.250	156.250	25b	161.850	161.850
06	156.300	156.300	26	157.300	161.900
07	156.350	160.950	27	157.350	161.950
07A	156.350	156.350	28	157.400	162.000
08	156.400	156.400	28b	162.000	162.000
09	156.450	156.450	60	156.025	160.625
10	156.500	156.500	61	156.075	160.675
11	156.550	156.550	61A	156.075	156.075
12	156.600	156.600	62	156.125	160.725
13	156.650	156.650	62A	156.125	156.125
14	156.700	156.700	63	156.175	160.775
15	156.750	156.750	63A	156.175	156.175
16	156.800	156.800	64	156.225	160.825
17	156.850	156.850	64A	156.225	156.225
18	156.900	161.500	65	156.275	160.875
18A	156.900	156.900	65A	156.275	156.275
19	156.950	161.550	66	156.325	160.925
19A	156.950	156.950	66A	156.325	156.325
20	157.000	161.600	67	156.375	156.375
20A	157.000	157.000	68	156.425	156.425
21	157.050	161.650	69	156.475	156.475

■ Weather channels (unit: MHz)

WX CH	Frequency
01	162.550
02	162.400
03	162.475
04	162.425
05	162.450
06	162.500
07	162.525
08	161.650
09	161.775
10	163.275

12 FREQUENCY TABLE

■ Other communications in the USA

◇ HF CB (Citizens Band) channels

CH	Frequency
1	26.965 MHz
2	26.975 MHz
3	26.985 MHz
4	27.005 MHz
5	27.015 MHz
6	27.025 MHz
7	27.035 MHz
8	27.055 MHz
9	27.065 MHz
10	27.075 MHz
11	27.085 MHz
12	27.105 MHz
13	27.115 MHz
14	27.125 MHz
15	27.135 MHz
16	27.155 MHz
17	27.165 MHz
18	27.175 MHz
19	27.185 MHz
20	27.205 MHz

CH	Frequency
21	27.215 MHz
22	27.225 MHz
23	27.255 MHz
24	27.235 MHz
25	27.245 MHz
26	27.265 MHz
27	27.275 MHz
28	27.285 MHz
29	27.295 MHz
30	27.305 MHz
31	27.315 MHz
32	27.325 MHz
33	27.335 MHz
34	27.345 MHz
35	27.355 MHz
36	27.365 MHz
37	27.375 MHz
38	27.385 MHz
39	27.395 MHz
40	27.405 MHz

◇ GMRS (General Mobile Radio Service) channels

Transceiver Receive	Transceiver Transmit
462.5500 MHz	467.5500 MHz
462.5625 MHz	
462.5750 MHz	467.5750 MHz
462.5875 MHz	
462.6000 MHz	467.6000 MHz
462.6125 MHz	
462.6250 MHz	467.6250 MHz
462.6375 MHz	
462.6500 MHz	467.6500 MHz
462.6625 MHz	
462.6750 MHz	467.6750 MHz
462.6875 MHz	
462.7000 MHz	467.7000 MHz
462.7125 MHz	
462.7250 MHz	467.7250 MHz

◇ BRS (Business Radio Service) channels

Dot color	Frequency
Red	151.625 MHz
Purple	151.955 MHz
Blue	154.570 MHz
Green	154.600 MHz
White	462.575 MHz
Black	462.625 MHz
Orange	462.675 MHz
Brown	464.500 MHz
Yellow	464.550 MHz
"J" Dot	467.763 MHz
"K" Dot	467.813 MHz
Silver Star	467.850 MHz
Gold Star	467.875 MHz
Red Star	467.900 MHz
Blue Star	467.925 MHz

◇ MURS channels

CH	Frequency
1	151.820 MHz
2	151.880 MHz
3	151.940 MHz
4	154.570 MHz
5	154.600 MHz

◇ FRS (Family Radio Service) channels

CH	Frequency	CH	Frequency
1	462.5625 MHz	8	467.5625 MHz
2	462.5875 MHz	9	467.5875 MHz
3	462.6125 MHz	10	467.6125 MHz
4	462.6375 MHz	11	467.6375 MHz
5	462.6625 MHz	12	467.6625 MHz
6	462.6875 MHz	13	467.6875 MHz
7	462.7125 MHz	14	467.7125 MHz

◆ **General aviation frequencies** (unit: MHz)

Frequency	Description
121.500	Emergencies
122.000	Flight Advisory Service
122.200	Flight Service Stations
122.700	Unicom— Uncontrolled airports
122.725	Unicom— Private airports
122.750	Unicom— Air-to-air communications
122.800	Unicom— Uncontrolled airports
122.900	Search & rescue training, & uncontrolled airports
122.950	Unicom— Controlled airports
123.000	Unicom— Uncontrolled airports
123.025	Helicopters— Air-to-air communications
123.050	Unicom— Heliports
123.075	Unicom— Heliports
123.100	Search & Rescue
123.300	Flight Schools
123.450	Air-to-air communications (unofficial)
123.500	Flight Schools
123.600	Flight Service Stations— Uncontrolled airports
148.125	Civil Air Patrol Repeaters— Secondary
148.150	Civil Air Patrol Repeaters— Primary
156.300	Aircraft-to-ship— safety
156.400	Aircraft-to-ship— commercial
156.425	Aircraft-to-ship— non-commercial
156.450	Aircraft-to-ship— commercial
156.625	Aircraft-to-ship— non-commercial
156.900	Aircraft-to-ship— commercial
243.000	Military Emergency “Guard”
255.400	Flight Advisory Service
257.800	Civilian Towers
311.000	SAC Primary
321.000	SAC Secondary
381.800	USCG— Primary

◆ **Cable TV (IRC)** (unit: MHz)

CH	Frequency range	Remarks
2– 13	54–216	(same as broadcast VHF)
14– 22	120–174	Mid band Ch. A–I
23– 36	216–300	Super band J–W
37– 53	300–402	Hyper band AA–QQ
54– 64	402–468	
65– 94	468–648	(Ultra band)
95– 99	90–120	Low band A5–A1
100–125	648–804	(Ultra band)

◆ **Wireless Microphones**

- 169.445 MHz
- 169.505 MHz
- 170.245 MHz
- 170.305 MHz
- 171.045 MHz
- 171.105 MHz
- 171.845 MHz
- 171.905 MHz

*Power limited to 1/20 watt. These frequencies are also used at drive-in windows at some fast-food restaurants.

12 FREQUENCY TABLE

■ Other communications— other countries

◇ LPD (Low Power Device) channels

(unit: MHz)

◇ PMR446 channels (unit: MHz)

CH	Frequency
1	433.075
2	433.100
3	433.125
4	433.150
5	433.175
6	433.200
7	433.225
8	433.250
9	433.275
10	433.300
11	433.325
12	433.350
13	433.375
14	433.400
15	433.425
16	433.450
17	433.475
18	433.500
19	433.525
20	433.550
21	433.575
22	433.600
23	433.625
24	433.650
25	433.675
26	433.700
27	433.725
28	433.750
29	433.775

CH	Frequency
30	433.800
31	433.825
32	433.850
33	433.875
34	433.900
35	433.925
36	433.950
37	433.975
38	434.000
39	434.025
40	434.050
41	434.075
42	434.100
43	434.125
44	434.150
45	434.175
46	434.200
47	434.225
48	434.250
49	434.275
50	434.300
51	434.325
52	434.350
53	434.375
54	434.400
55	434.425
56	434.450
57	434.475
58	434.500

CH	Frequency
59	434.525
60	434.550
61	434.575
62	434.600
63	434.625
64	434.650
65	434.675
66	434.700
67	434.725
68	434.750
69	434.775

CH	Frequency
1	446.00625
2	446.01875
3	446.03125
4	446.04375
5	446.05625
6	446.06875
7	446.08125
8	446.09375

◆ UHF C.R.S (Citizen Radio Service) channels

CH	Frequency	CH	Frequency
1	476.425 MHz	21	476.925 MHz
2	476.450 MHz	22	476.950 MHz
3	476.475 MHz	23	476.975 MHz
4	476.500 MHz	24	477.000 MHz
5	476.525 MHz	25	477.025 MHz
6	476.550 MHz	26	477.050 MHz
7	476.575 MHz	27	477.075 MHz
8	476.600 MHz	28	477.100 MHz
9	476.625 MHz	29	477.125 MHz
10	476.650 MHz	30	477.150 MHz
11	476.675 MHz	31	477.175 MHz
12	476.700 MHz	32	477.200 MHz
13	476.725 MHz	33	477.225 MHz
14	476.750 MHz	34	477.250 MHz
15	476.775 MHz	35	477.275 MHz
16	476.800 MHz	36	477.300 MHz
17	476.825 MHz	37	477.325 MHz
18	476.850 MHz	38	477.350 MHz
19	476.875 MHz	39	477.375 MHz
20	476.900 MHz	40	477.400 MHz

13 MAINTENANCE

■ Troubleshooting

If your transceiver seems to be malfunctioning, please check the following points before sending it to a service center.

PROBLEM	POSSIBLE CAUSE	SOLUTION	REF.
No power comes on.	<ul style="list-style-type: none"> • The batteries are exhausted. • The battery polarity is reversed. 	<ul style="list-style-type: none"> • Charge the battery pack. • Check the battery polarity. 	<p>p. 6 p. 6</p>
No sound comes from the speaker.	<ul style="list-style-type: none"> • Volume level is too low. • Squelch level is set too tight. • Different tone is selected with tone/DTCS squelch. 	<ul style="list-style-type: none"> • Push [▲] to obtain a suitable level. • While pushing and holding [SQL], rotate [DIAL] to set the squelch level. • Turn the appropriate function OFF. 	<p>p. 13 p. 14 p. 45</p>
Sensitivity is low and only strong signals are audible.	<ul style="list-style-type: none"> • Attenuator function is activated. 	<ul style="list-style-type: none"> • While pushing and holding [FUNC], push [SQL] momentarily to turn the attenuator function OFF. 	p. 15
Frequency cannot be set.	<ul style="list-style-type: none"> • The lock function is activated. 	<ul style="list-style-type: none"> • While pushing and holding [FUNC], push and hold [BAND] for 1 sec. to turn the function OFF. 	p. 18
No beep sound.	<ul style="list-style-type: none"> • Beep tones are turned OFF or the beep tone level is too low. 	<ul style="list-style-type: none"> • Turn beep tone ON or set the beep tone level to appropriate level in <i>set mode</i>. 	p. 54
Receive audio is distorted.	<ul style="list-style-type: none"> • The operating mode is not selected correctly. 	<ul style="list-style-type: none"> • While pushing and holding [FUNC], push [CALL] several times to select a suitable operating mode. 	p. 14
Transmitting is impossible.	<ul style="list-style-type: none"> • The battery pack is exhausted. • A frequency outside of the 144/430 MHz amateur bands is set 	<ul style="list-style-type: none"> • Charge the battery pack. • Set the frequency within the 144/430 MHz amateur bands. 	<p>p. 6 pgs. 9, 11</p>
No contact possible with another station.	<ul style="list-style-type: none"> • The other station is using tone squelch. • The transceiver is set to duplex 	<ul style="list-style-type: none"> • Turn the tone squelch function ON. • Set to simplex. 	<p>p. 45 p. 19</p>
Repeater cannot be accessed.	<ul style="list-style-type: none"> • Wrong offset frequency is programmed. • Priority watch is paused on the watching frequency 	<ul style="list-style-type: none"> • Correct the offset frequency. • Correct the subaudible tone frequency 	<p>p. 20 p. 21</p>

Troubleshooting (continued)

PROBLEM	POSSIBLE CAUSE	SOLUTION	REF.
Desired set mode item cannot be selected.	• “EXPAND” item is set to OFF.	• Turn “EXPAND” item ON.	p. 49
Programmed scan does not start.	• Program scan edges are not programmed.	• Program a pair of scan edge channels.	p. 36
Memory or bank scan does not start.	• No or only one memory or bank channel is programmed.	• Program at least 2 memory or bank channels	pgs. 24, 25
Charging indicator (BC-164) lights red while charging.	• The temperature is too hot or too cold around the charger (BC-164).	• Place the charger within the specified temperature range (+5°C to +35°C; +41°F to +95 °F), then charge the battery pack.	p. 8

■ Optional CP-21LR fuse replacement

If the fuse blows or the charger stops functioning while operating with the optional CP-21LR, find the source of the problem if possible, and replace the damaged fuse with a new, rated one (FGB 2 A) as shown at right.

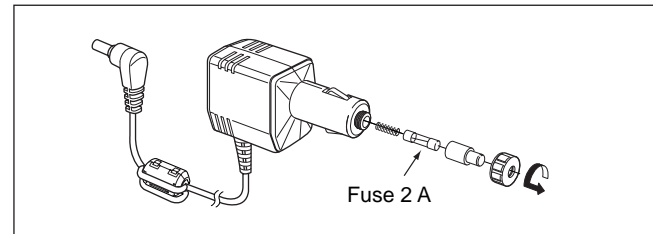

14 SPECIFICATIONS

■ Transceiver

◇ General

- Frequency coverage : (unit: MHz)

	Transmit	Receive
Europe UK	144–146, 430–440	0.495–999.990*
Italy	144–146, 430–434, 435–438	144–146, 430–434, 435–438
France	144–146, 430–440	0.495–29.995*, 50.2–51.2*, 76–135.995*, 144–146, 430–440

*Guaranteed 144–146 MHz, 430–440 MHz only,

- Mode : FM, AM (Rx only), WFM (Rx only)
- No. of memory channels : 1250 (incl. 50 scan edges, 200 auto memory write channels)
- No. of call channels : 2 channels
- Usable temp. range : –10°C to +60°C; +14°F to +140°F
- Tuning steps : 5, 6.25, 8.33, 9, 10, 12.5, 15, 20, 25, 30, 50, 100 and 200 kHz
- Frequency stability : ±6 ppm (–10°C to +60°C; +14°F to +140°F)
- Power supply : Specified battery pack (3.7 V DC)

- Current drain (at 3.7 V DC) :
 - Tx High 144, 430 MHz Less than 1.5 A
 - Tx Low 144 MHz 0.4 A (approx.)
 - 430 MHz 0.5 A (approx.)
 - Rx max.power Less than 150 mA
 - standby 80 mA (approx.)
- Antenna connector : SMA (50 Ω)
- External MIC/SP connector : 4-conductor 3.5(d) mm; 1/8" 8 Ω(SP)/2 kΩ(MIC)
- Dimensions : 47(W)×81(H)×28(D) mm; 1²⁷/₃₂(W)×3³/₁₆(H)×1³/₃₂(D) in (projections not included)
- Weight (approx.) : 160 g; 5.64 oz (with antenna and BP-243)

◇ Receiver

- Receive system : Double-conversion superheterodyne
- Intermediate frequencies : 1st 46.35 MHz (FM/AM)
14.85 MHz (WFM)
2nd 450 kHz
- Sensitivity : (except spurious points)
 - FM (at 12 dB SINAD)
 - 30.000–89.995 MHz Less than 0.45 μV
 - 90.000–143.995 MHz Less than 0.2 μV
 - 144.000–147.995 MHz Less than 0.18 μV
 - 148.000–179.995 MHz Less than 0.2 μV
 - 350.000–470.000 MHz 0.18 μV (typical)
 - (430.000–450.000 MHz Less than 0.18 μV)
 - 600.000–939.990 MHz Less than 1.4 μV
 - 940.000–999.990 MHz Less than 2.5 μV

- AM (at 10 dB S/N)
- | | |
|---------------------|-----------------------|
| 0.495–4.995 MHz | Less than 2.2 μ V |
| 5.000–29.995 MHz | Less than 1.4 μ V |
| 118.000–136.995 MHz | Less than 1.4 μ V |
- WFM (at 12 dB SINAD)
- | | |
|--------------------|-----------------------|
| 76.000–107.995 MHz | Less than 1.8 μ V |
| 600–799.990 MHz | Less than 2.5 μ V |
- Selectivity :

FM, AM	More than 12 kHz/6 dB
	Less than 30 kHz/60 dB
WFM	More than 150 kHz/10 dB
	Less than 700 kHz/20 dB
 - Spurious and image rejection ratio:

	More than 40dB
--	----------------
 - Audio output power : More than 50 mW at 10% distortion with an 8 Ω load
(at 3.7 V DC)
- ◇ **Transmitter**
- Modulation system : Variable reactance frequency modulation
 - Output power (at 3.7 V DC) :

144 MHz	High 1.5 W, Low 0.1 W (approx.)
430 MHz	High 1.0 W, Low 0.1 W (approx.)
 - Max. frequency deviation : \pm 5.0 kHz
 - Spurious emissions : Less than –60 dB (High power)
Less than –50 dB (Low power)

■ Battery pack (BP-243)

- Capacity : 1800 mAh
 - Battery voltage : 3.7 V
 - Charging temp. range : 0°C to +40°C; +32°F to +104°F
 - Usable temp. range : –20°C to +60°C; –4°F to +140°F
 - Storage temp. range :

Within 1 month	–20°C to +50°C; –4°F to +122°F
Within 3 months	–20°C to +35°C; –4°F to +95°F
Within 1 year	–20°C to +20°C; –4°F to +68°F
 - Dimensions : 35.3(W) \times 11.4(H) \times 53.1(D) mm;
(projections not included) 1³/₈(W) \times 7¹/₁₆(H) \times 2³/₃₂(D) in
 - Charging period (approx.) : 3 hrs.
 - Battery life*¹(approx.) : 20 hrs.
- *¹ Operating periods are calculated under the following conditions;
Tx : Rx : standby = 5 : 5 : 90, power save function: auto setting is activated

■ Battery charger (BC-164)

- Power supply : 12 to 16 V DC or the specified Icom AC adapter (BC-145LE/LUK)
- Charging current : 760 mA \pm 10%
- End voltage : 4.2 V \pm 0.1 V
- Charging temp. range : +5°C to +35°C; +41°F to +95 °F
- Dimensions : 67(W) \times 86.5(H) \times 50(D) mm;
(projections not included) 2⁵/₈(W) \times 3¹³/₃₂(H) \times 1³¹/₃₂(D) in
- Weight (approx.) : 95 g; 3.4 oz

15 OPTIONS

Options

AD-92SMA ANTENNA
CONNECTOR ADAPTER

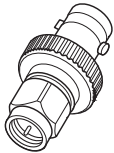

Allows you to connect an external antenna with a BNC connector.

OPC-782 PLUG ADAPTER CABLE

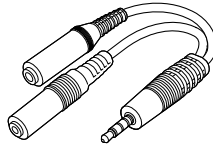

Used for connection with an Icom speaker-microphone or earphone.

SP-13 EARPHONE

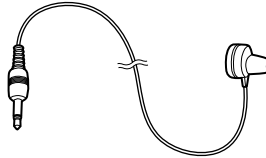

Provides clear receive audio in noisy environments. An optional OPC-782 is required for connection.

CP-21LR CIGARETTE LIGHTER
CABLE WITH NOISE FILTER

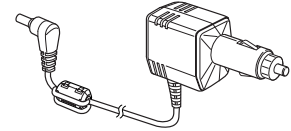

Allows you to charge the transceiver using supplied BC-164 BATTERY CHARGER.

BP-243 LI-ION BATTERY PACK
3.7 V/1800 mAh Lithium Ion battery pack. Same as supplied one.

OPC-474 CLONING CABLE
For connection between transceivers for data cloning.

CS-P7 CLONING SOFTWARE
+ **OPC-478U** CLONING CABLE
(USB type)

Allows you to transfer data, such as memories, and quickly and easily edit and store data via a PC (for Microsoft® Windows® 98/Me/2000/XP). Current RS-232C (DB 9-pin) type cloning cable, OPC-478, is also available.

BC-145LE/LUK AC ADAPTER
Same as supplied AC adapter with BC-164. (Not supplied with some versions)
Regularly charges the installed battery pack into transceiver.

◆ **HM-153 TIE-PIN MICROPHONE**

An optional OPC-782 is required for connection.

NOTE: Connect the OPC-782 after removing the [MIC/SP] cap (MIC/SP jack cover).

Keep the [MIC/SP] cap attached when jack are not in use to keep the contact clean.

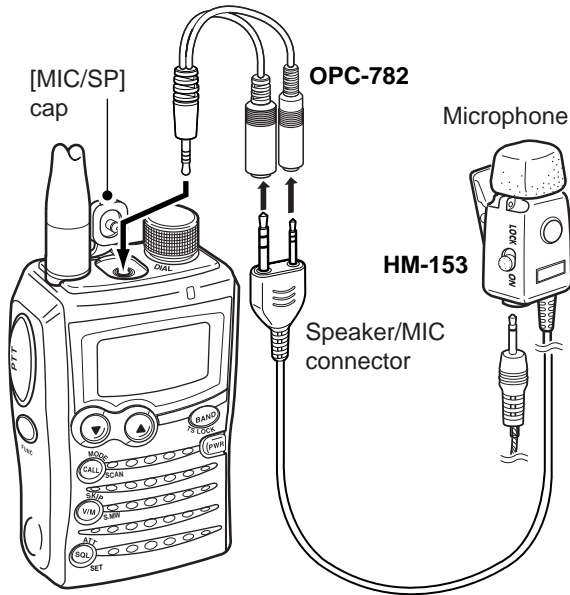

◆ **HM-153P TIE-PIN MICROPHONE**

Connects to the IC-E7 directly (without the OPC-782).

NOTE: Connect the HM-153P after removing the [MIC/SP] cap (MIC/SP jack cover).

Keep the [MIC/SP] cap attached when jack are not in use to keep the contact clean.

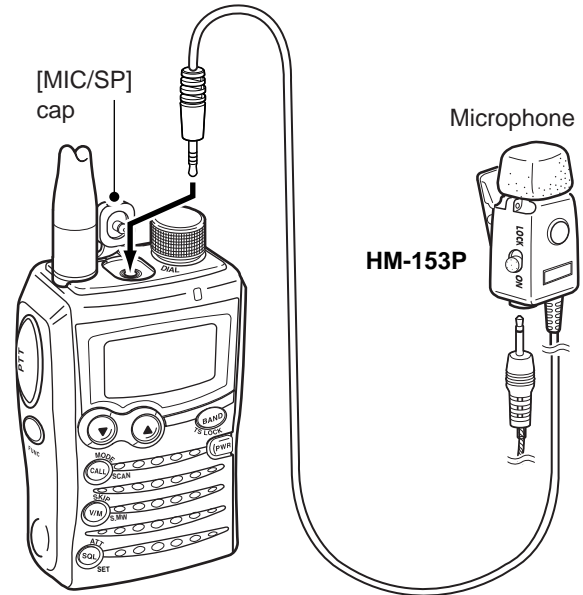

15 OPTIONS

◇ HM-128 EARPHONE MICROPHONE

An optional OPC-782 is required for connection.

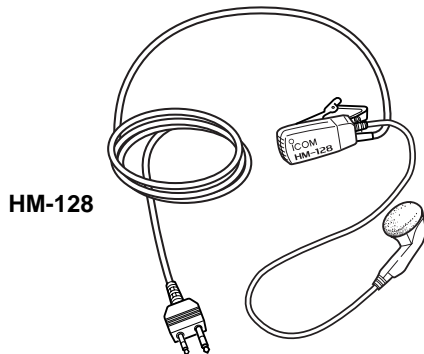

HM-128

◇ HM-131 SPEAKER MICROPHONE

An optional OPC-782 is required for connection.

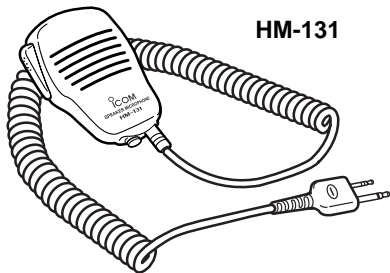

HM-131

◇ LC-161 CARRYING CASE

Helps protect the transceiver from scratches, etc.

NOTE: When using as below illustration, tension release loop protects the [MIC/SP] connector from being damaged by cable stress or vibration

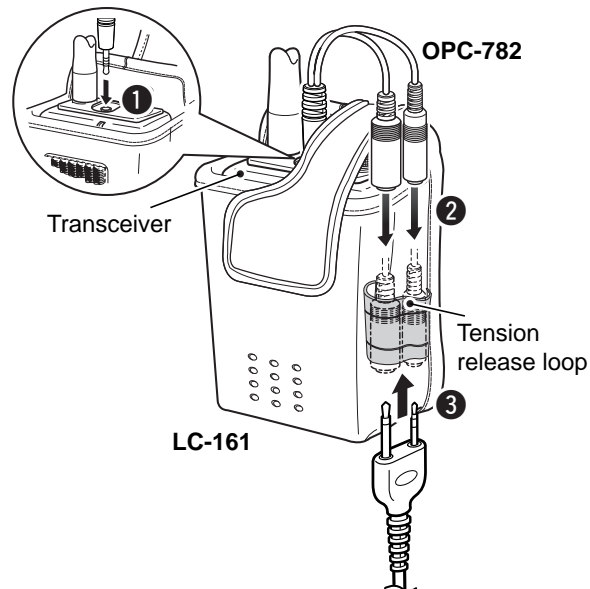

Important operating instructions are summed up in this and the following page for your simple reference. By cutting along the line and folding on the dotted line, it will become a card sized operating guide which can easily be carried in a card case or wallet, etc.

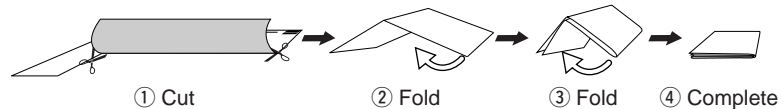

CUT HERE

<CUT HERE>

ICOM POCKET GUIDE IC-E7

■ VFO and memory mode selection

- Push [V/M] to toggle between VFO and memory mode.

■ Operating mode selection

- While pushing and holding [FUNC], push [CALL] several times to select the desired mode.

■ Audio level setting

- Push [▲] to increase, push [▼] to decrease the audio level.

■ Squelch level setting

- While pushing [SQL], rotate [DIAL] to set the squelch level.

■ Frequency band selection

- Push [BAND] several times, or while pushing and holding [BAND], rotate [DIAL] to select the desired frequency band.

■ Tuning step selection

- While pushing and holding [FUNC], push [BAND] to enter tuning step selection. Then rotate [DIAL] to select the desired tuning step.
 - Push [BAND] again to return to the previous condition.

■ Key lock function

- While pushing and holding [FUNC], push [BAND] for 1 sec. to toggle the key lock function ON and OFF.
 - "L" appears when the lock function is in use.

■ Monitor function

- Push and hold [SQL].
 - The 1st segment of S/Rf meter blinks.

■ Frequency setting

- Push [V/M] to select VFO mode.
- Rotate [DIAL] to set the desired operating frequency.
 - While pushing [FUNC], dial rotation changes frequency in 1 MHz steps.

■ Attenuator function

- While pushing and holding [FUNC], push [SQL] to toggle the attenuator function ON and OFF.
 - "ATT" appears when the attenuator function is in use.

■ Transmit power setting

- While pushing and holding [FUNC], push [PTT] to toggle the transmit output power High and Low.
 - "LOW" appears when the low output power is selected.

■ 1750 Hz tone burst

- Push [PTT] briefly, then push and hold [PTT] again for 1 to 2 sec.

■ Set mode setting

- While pushing and holding [FUNC], push and hold [SQL] for 1 sec. to enter set mode.
- Rotate [DIAL] to select the desired item.
- While pushing and holding [FUNC], rotate [DIAL] to set the desired value or condition.
- Push [SQL] to exit set mode.

■ Memory channel selection

- Push [V/M] to select memory mode.
- Rotate [DIAL] to set the desired memory channel.
 - While pushing [FUNC], dial rotation changes memory channel in 10 channels steps.

■ Memory bank channel selection

- ① Push **[V/M]** to select *memory mode*.
- ② Push **[BAND]** several times, or while pushing and holding **[BAND]**, rotate **[DIAL]** to select the desired bank group.
- ③ Rotate **[DIAL]** to select the desired bank channel.

■ Call channel selection

- ① Push **[CALL]** to select *call channel mode*.
- ② Rotate **[DIAL]** to select the desired call channel.
 - Push **[CALL]** again or push **[V/M]** to return to the previous condition.

■ Memory channel programming

- ① Set the desired frequency and other functions in *VFO mode*.
- ② Push and hold **[V/M]** for 1 sec. to enter *select memory write mode*.
 - 1 short and 1 long beeps sound.
- ③ Rotate **[DIAL]** to select the desired memory channel number.
- ④ Push and hold **[V/M]** for 1 sec. again to program the contents into the selected channel.
 - 3 beeps sound.

■ Scan skip setting

- ① Push **[V/M]** to select *memory mode*.
- ② Rotate **[DIAL]** to select the desired memory channel.
- ③ While pushing and holding **[FUNC]**, push **[V/M]** to set the skip setting (skip channel or skip frequency) ON and OFF.

■ VFO scans

- ① Push **[V/M]** to select *VFO mode*.
- ② Push and hold **[CALL]** for 1 sec.
 - One of scan type "ALL," "BAND" or "PROG xx" (xx= 0-24) appears.

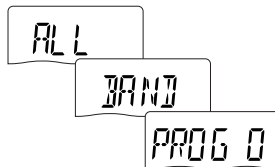

- ③ Rotate **[DIAL]** to select the desired scan type. Push **[CALL]** again to start the scan.
 - Rotate **[DIAL]** to change the scanning direction.
 - During scan, push **[V/M]** to start auto memory write scan.
- ④ Push **[CALL]** again to stop the scan.

■ Memory scans

- ① Push **[V/M]** to select *memory mode*.
- ② Push and hold **[CALL]** for 1 sec.
 - One of scan type "M ALL," "B ALL," "B LINK" or "BANK" appears, if memory banks are assigned.

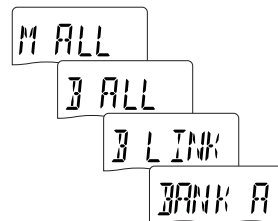

- ③ Rotate **[DIAL]** to select the desired scan type. Push **[CALL]** again to start the scan.
 - Rotate **[DIAL]** to change the scanning direction.
- ④ Push **[CALL]** again to stop the scan.

ABOUT CE

CE Versions of the IC-E7 which display the “CE” symbol on the serial number seal, comply with the essential requirements of the European Radio and Telecommunication Terminal Directive 1999/5/EC.



This warning symbol indicates that this equipment operates in non-harmonised frequency bands and/or may be subject to licensing conditions in the country of use. Be sure to check that you have the correct version of this radio or the correct programming of this radio, to comply with national licensing requirement.

INSTALLATION NOTES

- When transmitting with a portable radio, hold the radio in a vertical position with its microphone 2.5 to 5 centimeters away from your mouth. Keep antenna at least 2.5 centimeters from your head and body.
- If you wear a portable two-way radio on your body, ensure that the antenna is at least 2.5 centimeters from your body when transmitting.

DOC

We Icom Inc. Japan
1-1-32, Kamiminami, Hirano-ku
Osaka 547-0003, Japan

Declare on our sole responsibility that this equipment complies with the essential requirements of the Radio and Telecommunications Terminal Equipment Directive, 1995/5/EC, and that any applicable Essential Test Suite measurements have been performed.

Kind of equipment: VHF/UHF DUALBAND FM TRANSCEIVER

Type-designation: IC-E7

Version (where applicable): _____

This compliance is based on conformity with the following harmonised standards, specifications or documents:

- i) EN 301 489-1 v 1.4.1 (2002-08)
- ii) EN 301 489-15 v 1.2.1 (2002-08)
- iii) EN 301 783 v 1.1.1 (2000-09)
- iv) EN 60950-1 (2001): A11: 2004

DECLARATION OF CONFORMITY



Düsseldorf 24th Oct. 2005
Place and date of issue

Icom (Europe) GmbH
Himmelgeisterstraße 100
D-40225 Düsseldorf
Authorized representative name
H. Ikegami
General Manager

Signature

Icom Inc.

Count on us!

#02 Europe

<Intended Country of Use>			
<input checked="" type="checkbox"/> GER	<input type="checkbox"/> FRA	<input checked="" type="checkbox"/> ESP	<input checked="" type="checkbox"/> SWE
<input checked="" type="checkbox"/> AUT	<input checked="" type="checkbox"/> NED	<input checked="" type="checkbox"/> POR	<input checked="" type="checkbox"/> DEN
<input checked="" type="checkbox"/> GBR	<input checked="" type="checkbox"/> BEL	<input type="checkbox"/> ITA	<input checked="" type="checkbox"/> FIN
<input checked="" type="checkbox"/> IRL	<input checked="" type="checkbox"/> LUX	<input checked="" type="checkbox"/> GRE	<input type="checkbox"/> SUI
<input type="checkbox"/> NOR			

#03 Italy

<Intended Country of Use>			
<input type="checkbox"/> GER	<input type="checkbox"/> FRA	<input type="checkbox"/> ESP	<input type="checkbox"/> SWE
<input type="checkbox"/> AUT	<input type="checkbox"/> NED	<input type="checkbox"/> POR	<input type="checkbox"/> DEN
<input type="checkbox"/> GBR	<input type="checkbox"/> BEL	<input checked="" type="checkbox"/> ITA	<input type="checkbox"/> FIN
<input type="checkbox"/> IRL	<input type="checkbox"/> LUX	<input type="checkbox"/> GRE	<input type="checkbox"/> SUI
<input type="checkbox"/> NOR			

#10 France

<Intended Country of Use>			
<input type="checkbox"/> GER	<input checked="" type="checkbox"/> FRA	<input type="checkbox"/> ESP	<input type="checkbox"/> SWE
<input type="checkbox"/> AUT	<input type="checkbox"/> NED	<input type="checkbox"/> POR	<input type="checkbox"/> DEN
<input type="checkbox"/> GBR	<input type="checkbox"/> BEL	<input type="checkbox"/> ITA	<input type="checkbox"/> FIN
<input type="checkbox"/> IRL	<input type="checkbox"/> LUX	<input type="checkbox"/> GRE	<input type="checkbox"/> SUI
<input type="checkbox"/> NOR			

#11 UK

<Intended Country of Use>			
<input type="checkbox"/> GER	<input type="checkbox"/> FRA	<input type="checkbox"/> ESP	<input type="checkbox"/> SWE
<input type="checkbox"/> AUT	<input type="checkbox"/> NED	<input type="checkbox"/> POR	<input type="checkbox"/> DEN
<input checked="" type="checkbox"/> GBR	<input type="checkbox"/> BEL	<input type="checkbox"/> ITA	<input type="checkbox"/> FIN
<input type="checkbox"/> IRL	<input type="checkbox"/> LUX	<input type="checkbox"/> GRE	<input type="checkbox"/> SUI
<input type="checkbox"/> NOR			