

ICOM

INSTRUCTION MANUAL

UHF FM TRANSCEIVER

IC-4SAT
IC-4SET

Icom Inc.

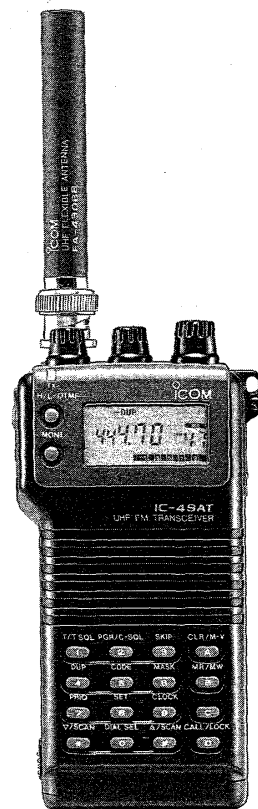

FIRST APPLYING POWER

The IC-4SAT/SET includes NiCd batteries and a rechargeable backup battery. If the batteries are low at the time you purchase the IC-4SAT/SET, the transceiver may not operate properly.

If the transceiver malfunctions, reset it as follows:

- 1) Connect the supplied wall charger to the [DC 13.8 V] jack on the top panel.
- 2) While pushing [F] and [A] (CLR), rotate [PWR/VOL] to turn ON power.
- 3) Release the switches.
 - The function display shows:
U.S.A. version 440.00 MHz
Other versions 430.00 MHz
- 4) Turn OFF power, then wait until the battery pack is fully charged.

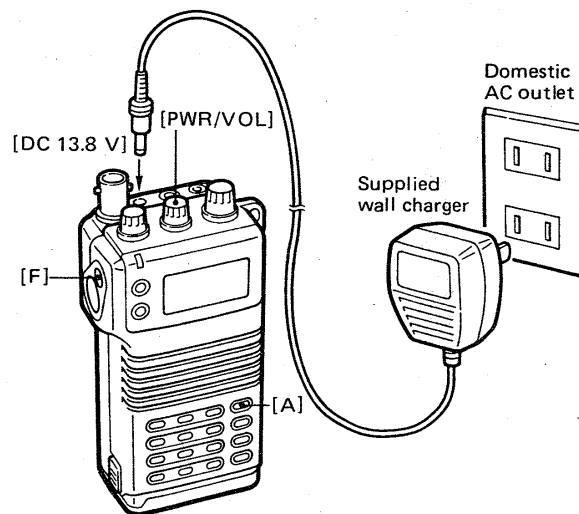

The internal batteries should be fully charged before using the transceiver.

TABLE OF CONTENTS

FIRST APPLYING POWER	i	8 SCAN OPERATION	23 ~ 26
TABLE OF CONTENTS	ii	8-1 Scan types	23
IMPORTANT	1	8-2 Scan operation	24
OPERATING NOTES	1	8-3 Setting scan conditions	25
CAUTIONS	1	9 PRIORITY WATCH	27 ~ 28
FOREWORD	2	9-1 Priority watch types	27
UNPACKING	2	9-2 Priority watch operation	28
1 FEATURES	3	10 DTMF MEMORY OPERATION	29
2 PRE-OPERATION	4 ~ 6	10-1 Programming a DTMF code	29
2-1 Attaching accessories	4	10-2 Transmitting a DTMF code	29
2-2 Power requirement	5	11 CLOCK AND TIMER OPERATION	30 ~ 32
3 MODE CONSTRUCTION	7 ~ 8	11-1 Clock mode	30
3-1 Mode types	7	11-2 Setting time	30
3-2 Mode construction chart	8	11-3 Power on timer	31
4 PANEL DESCRIPTION	9 ~ 13	11-4 Auto power off	32
4-1 Switches and controls	9	12 BEEP AND POWER SAVER	33
4-2 Keyboard	11	12-1 Beep tone ON/OFF	33
4-3 Function display	13	12-2 Power saver function	33
5 BASIC OPERATION	14 ~ 18	13 OPTIONAL UNIT OPERATION	34 ~ 41
5-1 Setting a frequency	14	13-1 Unit installations	34
5-2 Receiving	16	13-2 Pager function	35
5-3 Transmitting	16	13-3 Code squelch	40
5-4 Repeater operation	17	13-4 Subaudible tone encoder	41
6 MEMORY OPERATION	19 ~ 21	13-5 Tone squelch (CTCSS)	41
6-1 Selecting a memory channel	19	14 MAINTENANCE	42 ~ 43
6-2 Writing a memory	20	14-1 Troubleshooting	42
6-3 Transferring a memory	21	14-2 Backup battery	43
6-4 Masking a memory	21	14-3 Cleaning	43
7 CALL CHANNEL OPERATION	22	15 SPECIFICATIONS	44
7-1 Calling up the call channel	22	Schematic/block diagrams	Separate
7-2 Transferring the call channel	22		
7-3 Programming the call channel	22		

IMPORTANT

READ ALL INSTRUCTIONS carefully and completely before using the transceiver.

SAVE THIS INSTRUCTION MANUAL – This instruction manual contains important safety and operating instructions for the IC-4SAT/SET.

OPERATING NOTES

BE CAREFUL! When transmitting for a long time with high output power, the rear panel may become hot.

When using the transceiver with the internal battery, we recommend operating with low output power. Battery power will be discharged quickly if the transceiver is operated continuously using high output power.

CAUTIONS

NEVER connect the transceiver via the [DC 13.8 V] jack to an AC outlet or to a power source of more than 16 V DC. These connections will ruin the transceiver.

NEVER connect the transceiver to a power source using reverse polarity. This connection will harm internal transceiver circuitry.

NEVER allow children to touch the transceiver.

NEVER use a non-recommended charger for charging. Suggested chargers are described on p. 5.

AVOID using or placing the transceiver in areas with temperatures below -10°C ($+14^{\circ}\text{F}$) or above $+60^{\circ}\text{C}$ ($+140^{\circ}\text{F}$).

AVOID placing the transceiver in direct sunlight.

FOREWORD

Thank you for purchasing the **IC-4SAT/SET** UHF FM TRANSCEIVER. The **IC-4SAT/SET** is state-of-the-art handheld that fits comfortably in the palm of your hand and combines ease of use with multi-operational capability.

Features include keyboard selection, 5 W output power, a power saver function, auto power off, power on timer, built-in clock, 48 memory channels, 10 DTMF memory channels, priority watch, convenient scan functions, etc. In fact, the **IC-4SAT/SET** has just about everything you could ask of a transceiver. And all these functions are built into a small handheld designed for very easy operation.

To fully appreciate the capabilities of your new **IC-4SAT/SET** please read this instruction manual thoroughly before attempting operation. If you have any questions regarding the operation of the **IC-4SAT/SET**, feel free to contact your nearest authorized Icom Dealer or Service Center.

UNPACKING

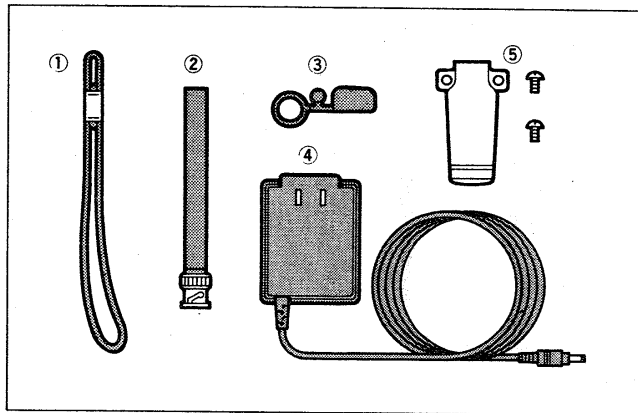

Accessories included with the IC-4SAT/SET:		QTY.
①	Handstrap	1
②	Antenna	1
③	Rainproof cap	1
④	Wall charger*	1
⑤	Belt clip and screws	1 set

* BC-74A for U.S.A. version
BC-74V for for Australia version
BC-73D for Europe version
BC-73E for Asia version

SLIM AND UNBELIEVABLY COMPACT

Transceiver dimensions are just 49 mm (1.9")W x 103 mm (4.1")H x 35 mm (1.4")D. And these dimensions include the internal battery! What's more, the rounded body design gives you a feeling of even smaller transceiver dimensions.

CONVENIENT FREQUENCY SELECTION

With the IC-4SAT/SET you can immediately select a desired operating frequency using keyboard entry or by rotating the tuning control.

EXTERNAL DC POWER JACK

Another Icom innovation. Even though the IC-4SAT/SET is incredibly small, we've equipped it with an external DC power jack. Operate the transceiver with either the internal battery, an external battery pack (optional) or an external power source such as a power supply, cigarette lighter socket in a vehicle, etc. No optional DC-DC converter is necessary. And battery charging can also be performed via this jack.

5 W OUTPUT POWER

It's hard to imagine 5 W of output power coming from such a small transceiver. Yet the IC-4SAT/SET achieves this when connected to a 13.8 V DC power source. Also, 3 selectable low output power levels give you amazing versatility when transmitting.

AUTO POWER OFF AND POWER SAVER FUNCTIONS

The IC-4SAT/SET has an advanced power saver design for conserving battery pack power. When no signal is received or no switch is pushed for 5 seconds, the power saver function reduces current consumption to approx. 1/4. And after 60 minutes*, power is automatically turned OFF by the auto power off function.

* Selectable in 3 steps : 20, 40 and 60 min.

10 DTMF MEMORY CHANNELS

The transceiver has 10 DTMF memory channels which memorize a DTMF code of up to 15 digits. Now there's no need for you to remember each DTMF code when accessing repeaters, using telephone lines, etc.

ADDITIONAL FEATURES

- 48 memory channels with masking function.
- 3 scan types: programmed, full and memory scans.
- Frequency skip and memory channel skip functions.
- Priority watch to check a particular frequency.
- Built-in clock and power on timer.
- Optional paging and code squelch functions.
- Dial select function for quick tuning selection.

2-1 Attaching accessories

●ANTENNA AND RAINPROOF CAP

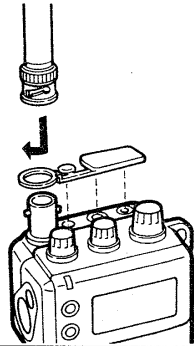

Attach the rainproof cap before connecting the antenna when desired.

Insert the supplied antenna onto the antenna connector and twist the connector on the antenna as shown in the diagram at left.

●HANDSTRAP ATTACHMENT

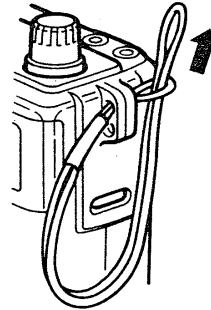

The handstrap allows you to easily carry the transceiver. Attach the handstrap as shown in the diagram at left.

●BELT CLIP

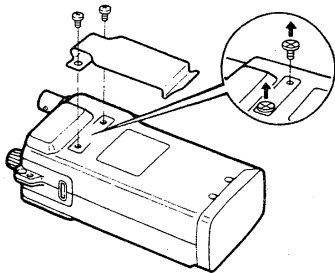

The belt clip allows you to attach the transceiver to your belt.

Remove the plastic screws when attaching the belt clip.

●BOTTOM CAP REMOVAL

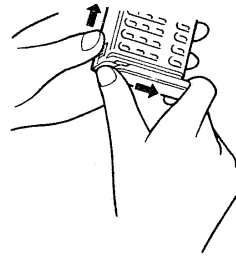

Push the bottom cap release button upwards, then slide the bottom cap to the right with the transceiver facing you.

To attach the bottom cap or an optional battery pack, mate the notched ends of the transceiver and bottom cap (or a battery pack) and slide until a click sound is heard.

2 PRE-OPERATION

2-2 Power requirement

(1) POWER SOURCE

Use any of the following power sources when operating your IC-4SAT/SET:

- Internal battery.
- 6 ~ 16 V DC external power source through the [DC 13.8 V] jack.
- Either optional battery packs BP-81 ~ BP-85 or six AA (R6) size dry batteries or NiCd batteries with an optional BP-90 BATTERY CASE.

When attaching a battery pack or connecting an external power source, the internal battery is disconnected from the circuitry.

When the attached battery pack is discharged remove it and use the internal battery.

(2) CHARGING THE INTERNAL BATTERY

To charge the internal battery, connect the supplied wall charger to the [DC 13.8 V] jack on the transceiver, or use an optional BC-72 DESKTOP CHARGER.* The BC-72 allows rapid charging.

*An optional BA-12 BATTERY CHARGE ADAPTER is necessary when charging with the BC-72.

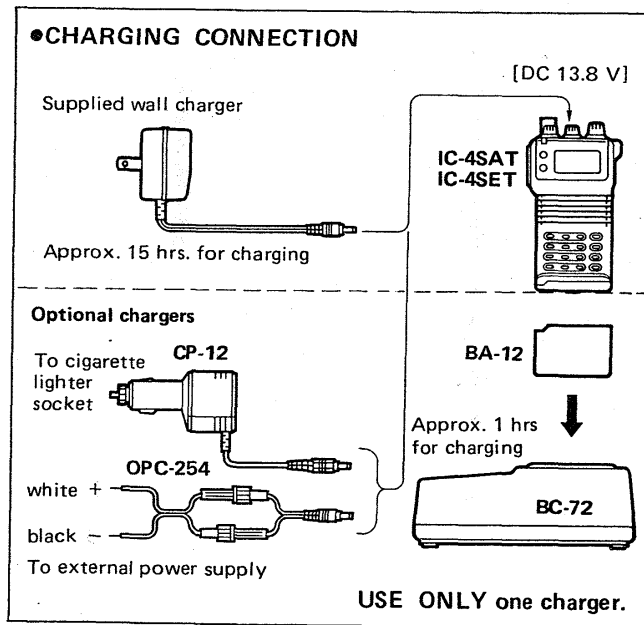

(3) CHARGING AN OPTIONAL BATTERY PACK

An optional battery pack can be charged in a similar way as the internal battery.

The internal battery will not be charged when an external battery pack is connected.

●CHARGING CONNECTION

WALL CHARGER

BC-74A/E/D/V can charge BP-81 ~ 85, 90.

BC-73E/D can charge BP-81 or 82 only.

[DC 13.8 V]
(BP-81 ~ 84, 90)

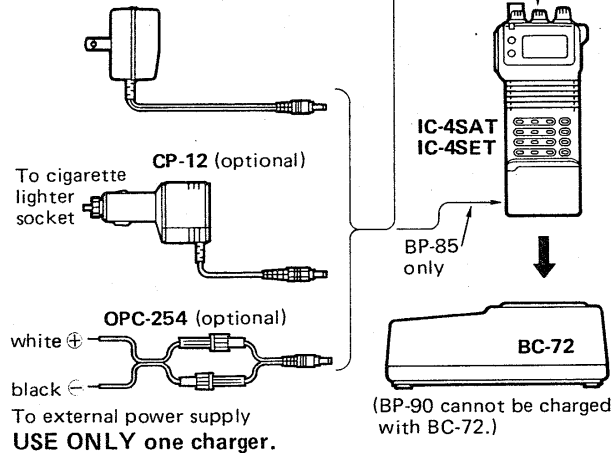

(4) USING THE BATTERY PACK WISELY

The battery pack is designed to withstand recharging periods longer than 1 week or more and can be fully discharged. However, overcharging or complete discharging shorten the life of a battery. The battery pack can be recharged about 300 times but its battery life can be lengthened to about 500 times as follows:

1. Avoid overcharging. Charging times should be less than 48 hours.
2. Use battery capacity almost completely. We recommend battery charging after transmitting becomes impossible.

(5) BATTERY LIFE

The battery packs below have the following operating times when transmitting at high power for 1 min., receiving for 1 min. and standby for 8 min.

BATTERY PACK	VOLTAGE	OPERATING TIME
INTERNAL BATTERY	7.2 V	Approx. 2.2 hrs.
BP-81	7.2 V	Approx. 0.8 hrs.
BP-82	7.2 V	Approx. 2.2 hrs.
BP-83	7.2 V	Approx. 4.5 hrs.
BP-84	7.2 V	Approx. 7.6 hrs.
BP-85	12 V	Approx. 1.9 hrs.

Operating times may vary depending on your operating conditions such as output power, temperature etc.

3

MODE CONSTRUCTION

3-1 Mode types

The transceiver has 5 different modes and 1 call channel for versatile, multi-function operations.

• VFO MODE

Used for normal operations over the entire band.

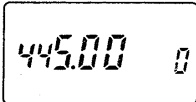

• CLOCK MODE

Used for setting the clock time, power on timer and auto power off time.

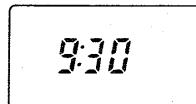

• MEMORY MODE

Used for operating the transceiver using memory channel contents. 48 memory channels are available for programming. Memory channels 0 ~ 9 independently program offset frequencies and optional subaudible tone frequencies.

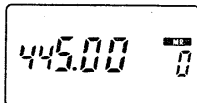

• DTMF MEMORY MODE

Used for programming DTMF codes. 10 DTMF memory channels are available and each channel has up to 15 digits of programming capability.

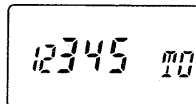

• SET MODE

Used for initializing the transceiver conditions as described on p. 8.

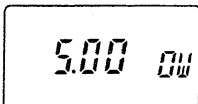

• CALL CHANNEL

One-touch call up channel. Program your most-often-used frequency.

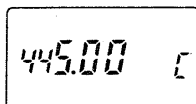

3-2 Mode construction chart

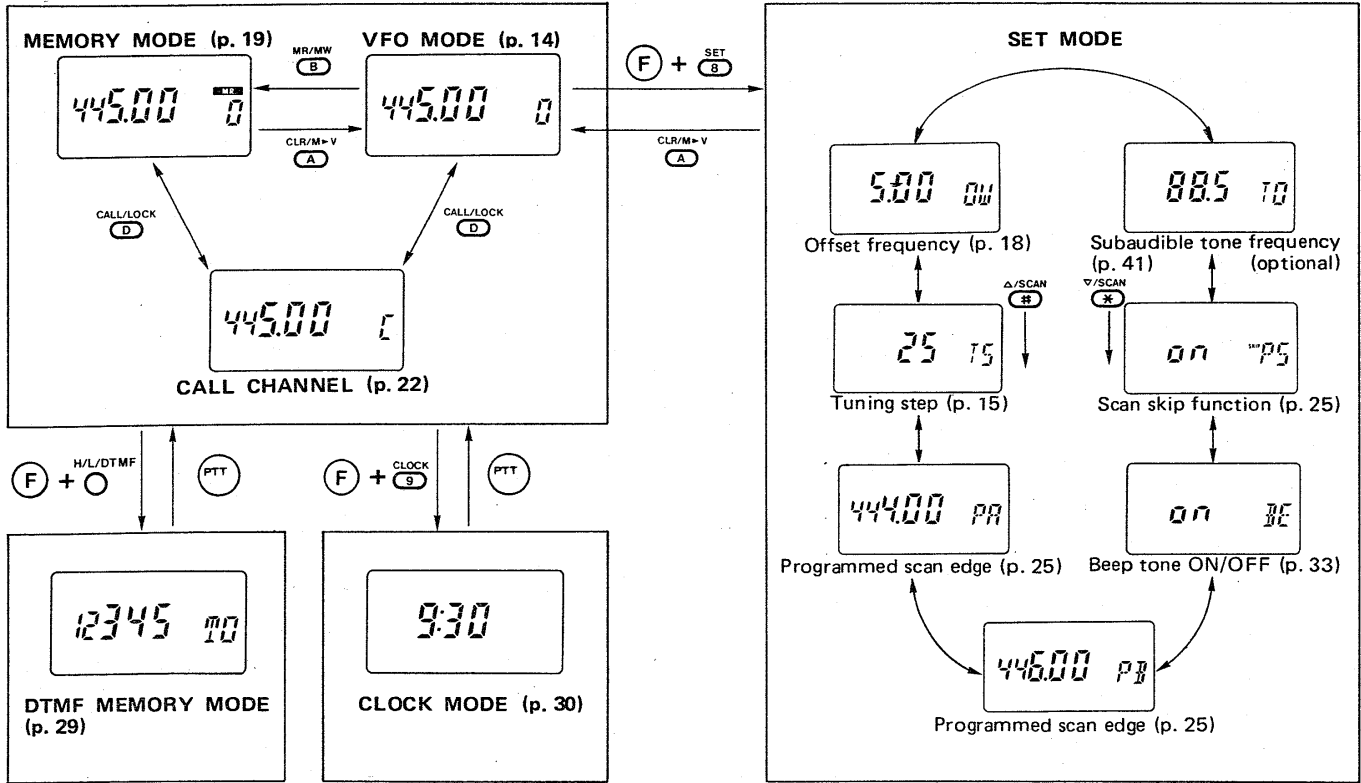

4-1 Switches and controls

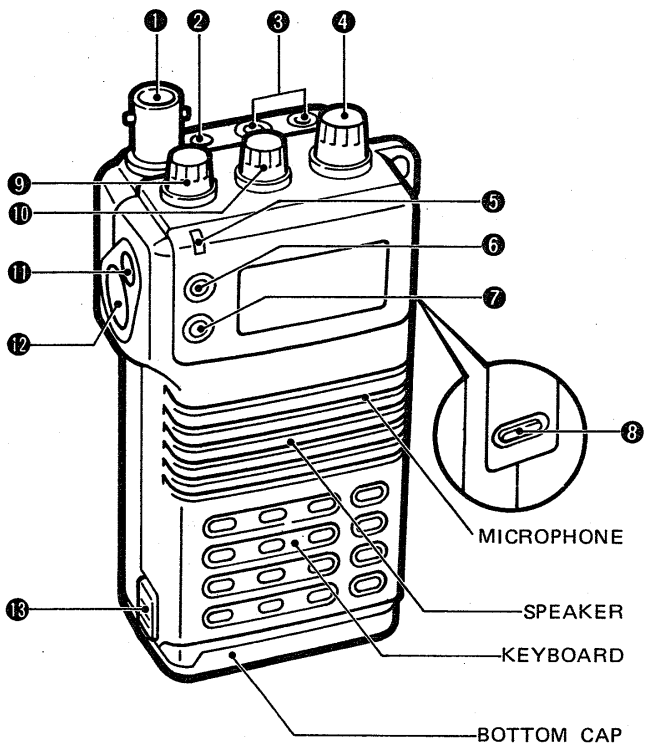
**① ANTENNA CONNECTOR**

Connects the supplied flexible antenna. (p. 4)

② EXTERNAL DC POWER JACK [DC 13.8 V]

Connects the supplied wall charger for charging the internal or attached battery pack.

Allows operation with a 13.8 V DC power source using optional cables CP-12 or OPC-254 (see attached "List of options" for details).

The wall charger cannot be used to operate the transceiver.

③ EXTERNAL SPEAKER AND MICROPHONE JACKS [SP] / [MIC]

Connect an optional speaker-microphone or headset, if desired (see attached "List of options" for details).

The internal speaker and microphone will not function when either option is connected.

④ TUNING CONTROL

Sets an operating frequency or a memory channel.

⑤ TRANSMIT/RECEIVE INDICATOR

Lights up in green when squelch opens; lights up in red when transmitting.

Green lighting can be turned OFF for power saving, when required. (p. 16)

⑥ TRANSMIT POWER SWITCH [H/L/DTMF]

Selects high or low transmit output power. (p. 16)

While pushing this switch and rotating the tuning control, the low output power level changes. (p. 17)

While pushing [F], push this switch to enter DTMF MEMORY mode. (p. 29)

⑦ MONITOR SWITCH [MONI]

Opens the squelch and optional tone squelch. (p. 16)

Checks the transmit frequency when duplex is selected. (p. 17)

While pushing [F], push this switch to turn OFF the green receive indicator. This function conserves battery pack power. (p. 16)

⑧ LIGHT SWITCH [LIGHT]

Lights the display backlight for approx. 5 sec.

While pushing [F], push this switch for continuous lighting. To turn OFF, push this switch again.

While pushing this switch together with some digit keys, turn power ON to initialize the scan resume condition (p. 25), power saver duty cycle (p. 33) or PTT switch function. (p. 17)

⑨ SQUELCH CONTROL [SQUELCH]

Varies the squelch threshold point for audio mute.

⑩ VOLUME CONTROL [PWR/VOL]

Turns power ON and adjusts the audio level.

⑪ FUNCTION SWITCH [F]

While pushing this switch, other switches function as a secondary function.

⑫ PTT SWITCH [PTT]

Push and hold to transmit; release to receive.

⑬ BATTERY PACK RELEASE BUTTON

Opens the latch for bottom cap removal when pushed upwards. (p. 4)

4 PANEL DESCRIPTION

4-2 Keyboard

KEY	FUNCTION	SECONDARY FUNCTION (While pushing [F])
T/T SQL 1		Turns ON and OFF an optional subaudible tone encoder or tone squelch function. (p. 41)
PGR/C-SQL 2		Turns ON and OFF an optional pager or code squelch function. (pgs. 38 ~ 40)
SKIP 3		When selecting MEMORY mode: Programs the memory channel as the skip channel. (p. 26)
DUP 4		Selects in sequence: -duplex → +duplex → simplex. (p. 17)
CODE 5		Programs an optional code memory for pager and code squelch functions. (p. 37)
MASK 6		When selecting MEMORY mode: Masks (makes blank) the memory channel. (p. 21)
PRIO 7		Starts priority watch (p. 28).
SET 8		<ul style="list-style-type: none"> • When selecting VFO mode: Enters SET mode. (p. 8) • When selecting DTMF MEMORY mode: Programs DTMF code. (p. 29) • When selecting CLOCK mode: Programs clock or timer time. (p. 30) • When selecting MEMORY mode or the call channel: No function.
CLOCK 9		Enters CLOCK mode. (p. 30)
DIAL SEL 0		Selects a dial select step. (p. 15)

- When selecting VFO mode: Enter the digit for the operating frequency. (p. 14)

- When selecting MEMORY mode: Select the memory channel in the same 10-digit channels. (p. 20)

- When selecting DTMF MEMORY mode: Select the DTMF memory channel. (p. 29)

- When transmitting: Transmit DTMF digits.

KEY	FUNCTION	SECONDARY FINCTION (While pushing [F])
<p>▽/SCAN * △/SCAN #</p>	<ul style="list-style-type: none"> •When selecting VFO or MEMORY mode: Change the operating frequency or memory channel. (pgs. 14, 20) To start full scan or memory scan, push and hold either key. (p. 24) •When selecting SET or CLOCK mode: Change the display contents. (pgs. 8, 30) •When selecting DTMF MEMORY mode: No function. 	<p>When selecting VFO mode: Start programmed scan. (p. 24)</p>
<p>CLR/M→V A</p>	<ul style="list-style-type: none"> •When selecting VFO mode: Clears input digit before entry. (p. 14) •When selecting MEMORY mode or the call channel: Returns to VFO mode. 	<p>When selecting MEMORY mode or call channel: Transfers the contents into VFO mode by pushing and holding. (pgs. 21, 22)</p>
<p>MR/MW B</p>	<ul style="list-style-type: none"> •When selecting VFO mode: Selects MEMORY mode. (p. 19) •When selecting MEMORY mode: Changes the channel in 10 digits. (p. 20) 	<ul style="list-style-type: none"> •When selecting VFO mode: Writes the VFO contents into the memory channel by pushing and holding. (p. 20) •When selecting the call channel: Writes the VFO contents into the call channel by pushing and holding. (p. 22)
<p>C</p>	<p>Used for manual DTMF transmit only.</p>	<p>No function.</p>
<p>CALL/LOCK D</p>	<p>Selects the call channel. (p. 22)</p>	<p>Turns ON the lock function. (p. 15)</p>

4 PANEL DESCRIPTION

4-3 Function display

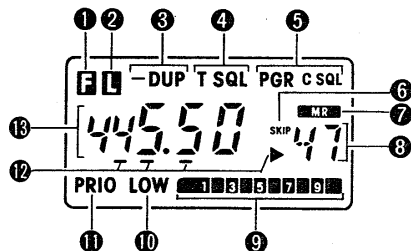

❶ FUNCTION INDICATOR

Appears while pushing [F].

❷ LOCK INDICATOR

Appears when the lock function is activated. (p. 15)

❸ DUPLEX INDICATOR

"DUP" or "-DUP" appears when duplex is selected. (p. 17).

❹ TONE INDICATOR

Appears when operating the subaudible tone encoder or tone squelch function. (an optional UT-50 or UT-51, see "List of options," is necessary.) (pgs. 40, 41)

❺ CODE SQUELCH AND PAGER INDICATORS

Either indicator appears when operating the code squelch or pager function. (an optional UT-49, see "List of options," is necessary.)

❻ SKIP INDICATOR

Appears when selecting the memory channel programmed as the skip channel. (p. 26)

Blinks during full scan or programmed scan. (p. 24)

❼ MEMORY INDICATOR

Appears when selecting MEMORY mode. (p. 19)

Blinks during memory scan. (p. 24)

❽ MEMORY CHANNEL READOUT

Shows the selected memory channel number.

"C" appears when calling up the call channel. (p. 22)

❾ S/R F INDICATOR

Shows the relative signal strength when receiving, and the output power selection when transmitting. (p. 16)

❿ LOW POWER INDICATOR

Appears when selecting low output power. (p. 16)

⓫ PRIORITY INDICATOR

Appears when activating the priority watch. (p. 27)

⓬ DIAL SELECT INDICATORS

One indicator appears while pushing [F]. It shows the dial select step. (p. 15)

⓭ FREQUENCY READOUT

Shows an operating frequency.

5-1 Setting a frequency

Before applying power, see the inside front cover to reset the transceiver.

(1) USING THE TUNING CONTROL

- 1) Rotate [PWR/VOL] to turn power ON.
- 2) Push [A] (CLR) to select VFO mode.
- 3) Rotate the tuning control to set an operating frequency.
- 4) Use the dial select function for quick tuning:
 - While pushing [F], rotate the tuning control.
 - See p. 15 for changing the dial select step.

(2) USING THE KEYBOARD

- 1) Turn power ON. See steps 1 and 2 at left.
- 2) Push the appropriate digit key to input the frequency.
 - When the wrong digit is input, push [A] (CLR) to clear the input.
 - Push [5] or [0] for the final digit (4th pushing). (Not applicable when the 12.5 kHz step is selected.)
 - A decimal point appears when the input frequency is entered.
- 3) To change the frequency in the tuning step, push [*] (▽) or [#] (△).
 - Pushing [*] or [#] for more than 0.5 sec. starts full scan.

EXAMPLE: Setting frequency at 445.50 MHz using the keyboard.

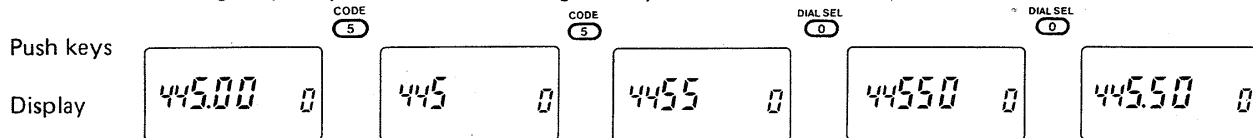

5 BASIC OPERATION

(3) SETTING A TUNING OR DIAL SELECT STEP

USING SET MODE

■ SETTING A TUNING STEP

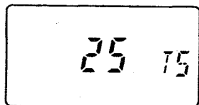

The display shows the tuning step for 25 kHz.

- 1) Push [A] (CLR) to select VFO mode.
- 2) While pushing [F], push [8] (SET) to enter SET mode.
 - Refer to p. 8 for SET mode details.
- 3) Push [*] (▽) or [#] (△) until "TS" appears as shown above.
- 4) Rotate the tuning control to select the desired tuning step.
- 5) Push [A] (CLR) to exit SET mode.

■ SETTING A DIAL SELECT STEP

While pushing [F], the tuning control changes the frequency in the following quick step.

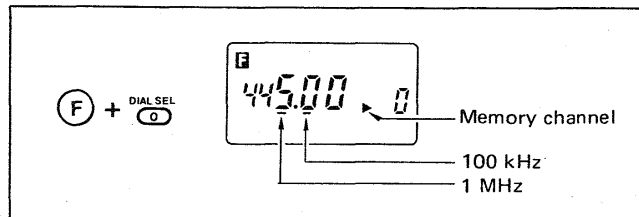

While pushing [F], push [0] (DIAL SEL) to select the dial select step.

- Each push of the switches changes the step.

(4) LOCK FUNCTION

The lock function electronically locks the tuning control and keyboard to prevent the frequency from changing accidentally.

- 1) While pushing [F], push [D] (CALL/LOCK) to turn ON the lock function.
- 2) Repeat step 1 to turn OFF the function.

5-2 Receiving

- 1) Set [SQUELCH] to maximum counterclockwise.
- 2) Rotate [PWR/VOL] to turn ON power and adjust the audio level.
- 3) Rotate [SQUELCH] clockwise until the noise disappears.
- 4) Set the operating frequency using the tuning control or keyboard.
 - Refer to p. 14 for details.
- 5) When receiving a signal on the set frequency:
 - Squelch opens and the transceiver emits audio.
 - The S/R/F indicator shows relative signal strength.
- 6) Use [MONI] when a weak signal cannot open the squelch completely.

The receive indicator lights when the squelch opens. However, it can be turned OFF to conserve battery pack power.

- While pushing [F], push [MONI] to turn the indicator OFF or ON.

5-3 Transmitting

CAUTION: Transmitting without an antenna may damage the transceiver.

NOTE: To prevent interference, listen on the frequency before transmitting using [MONI].

- 1) Set the operating frequency using the tuning control or keyboard.
 - Refer to p. 14 for details.
- 2) Push [H/L] to select the output power.
 - "LOW" appears when selecting low power and disappears when selecting high power.
 - The low output power level can be changed. (p. 17)
- 3) Push and hold [PTT] to transmit.
 - The [TX] indicator lights up in red.
 - The S/R/F indicator shows output power selection.
- 4) Speak into the microphone using your normal voice level.
 - **DO NOT** hold the transceiver too closely to your mouth or speak too loudly. This may distort the signal.
- 5) Release [PTT] to receive.

5 BASIC OPERATION

■ SELECTING LOW OUTPUT POWER

Low output power can be selected in 3 levels to suit operating requirements such as communication distance, battery conservation, etc.

POWER SELECTION	S/R/F INDICATOR	OUTPUT POWER	
		Using 13.8 V DC	Using the internal battery
LOW 1	LOW ■■■■	0.5 W	0.5 W
LOW 2	LOW ■■■■■■	1.5 W	1.5 W
LOW 3	LOW ■■■■■■■■	3.5 W	1.5 W
HIGH	■■■■■■■■■■	5.0 W	1.5 W

Above values are typical.

While pushing [H/L], rotate the tuning control.

- The S/R/F indicator shows output power selection as described above.

WITH POWER ON

■ PTT LOCK FUNCTION

Transmitting can be inhibited to prevent accidental transmission.

- While pushing the following switches, turn power ON:
 - [0] + [LIGHT]: [PTT] is electronically locked.
 - [*] + [LIGHT]: [PTT] is activated.

5-4 Repeater operation

When operating the transceiver with a station through a repeater, the repeater transmits your signal, allowing you to communicate with long distance stations even when low output power is used.

- 1) Set the operating frequency using the tuning control or keyboard.
 - Refer to p. 14 for details.
- 2) While pushing [F], push [4] (DUP) for -duplex and again for +duplex.
 - "-DUP" or "DUP" appears.
 - "-DUP": Transmit freq. = Receive freq. - Offset freq.
 - "DUP": Transmit freq. = Receive freq. + Offset freq.
- 3) Push and hold [PTT] to transmit.
 - The displayed frequency automatically changes to the repeater input frequency.
 - See right (p. 18) when tones are necessary to operate a repeater.
- 4) Release [PTT] to receive.
- 5) Push [MONI] to check the repeater input frequency whether the frequency is busy or not.

● **SUBAUDIBLE TONE ENCODER**

(An optional UT-50 or UT-51 is necessary)

"T" appears

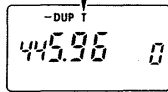

While pushing [F], push [1] (T/SQL) until "T" appears.

To set a subaudible tone frequency, see p. 41

● **DTMF TONES**

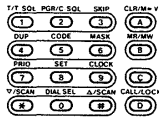

While pushing [PTT], push the desired digit key to transmit DTMF tones.

The transceiver has 10 DTMF memory channels. Each memory has the capability to memorize up to 15 DTMF digits. See p. 29 for details.

● **1750 Hz TONE CALL**
(IC-4SET only)



Quickly push [PTT] 2 times and briefly hold [PTT] down (second push).

Release and then push [PTT] again to transmit your voice.

USING **SET MODE**

■ **OFFSET FREQUENCY SETTING**

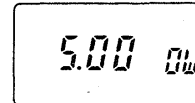

The display shows the offset frequency for 5.0 MHz

- 1) Push [A] (CLR) to select VFO mode.
- 2) While pushing [F], push [8] (SET) to enter SET mode.
 - Refer to p. 8 for SET mode details.
- 3) Push [*] (▽) or [#] (△) until "OW" appears as shown above.
- 4) Set the desired offset frequency using the tuning control.
- 5) Push [A] (CLR) to exit SET mode.

6-1 Selecting a memory channel

The transceiver has 48 memory channels for storing your most-often-used frequencies such as for use with repeaters, group calls, etc.

When first applying power or after resetting, memory channels 10 ~ 47 are blank.

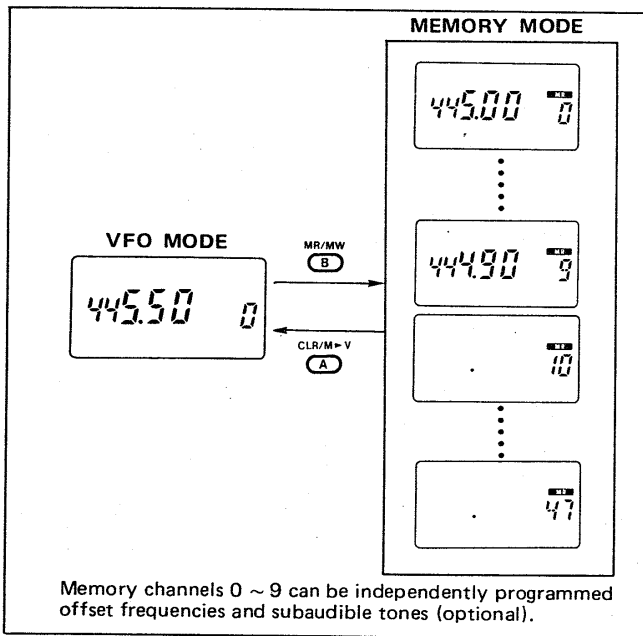

(1) USING THE TUNING CONTROL

- 1) Push [B] (MR) to select MEMORY mode.
 - "MR" appears.
- 2) Rotate the tuning control to select the desired memory channel.

NOTE: Only programmed channels can be selected.

- 3) To select a blanked memory channel:
 - While pushing [F], rotate the tuning control.
- 4) Push [A] (CLR) to return to VFO mode.

The dial select function is helpful for selecting a memory channel number in VFO mode. See p. 15 for setting the dial select step for a memory channel.

(2) USING THE KEYBOARD

- 1) Push [B] (MR) several times to select the desired 10-digit memory channels.
- 2) Push the appropriate digit key to select the memory channel.
 - Pushing [*] (▽) and [#] (△) also allows you to select memory channels.
- 3) Push [A] (CLR) to return to VFO mode.

6-2 Writing a memory

- 1) Select the memory channel to be programmed.
 - See Section 6-1 for details.
- 2) Push [A] (CLR) to select VFO mode.
- 3) Set the frequency (and duplex when required).
- 4) While pushing [F], push and hold [B] (MR/MW) until the transceiver emits 3 beeps.
- 5) The memory has been written into the memory channel. To check the contents, push [B] (MR).

EXAMPLE: Selecting memory channel 35 using the keyboard.

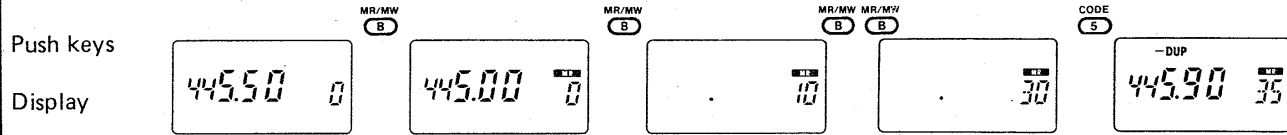

EXAMPLE: Writing 445.57 MHz into memory channel 40.

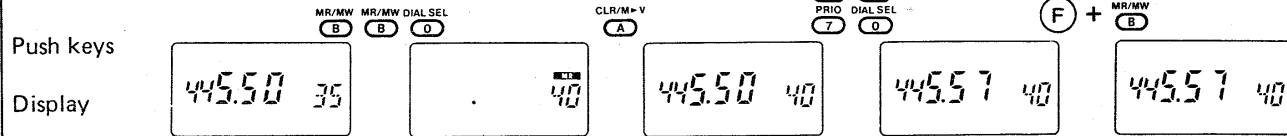

6 MEMORY OPERATION

6-3 Transferring a memory

Copy and transfer the displayed memory contents into the VFO. This function is useful for searching for signals around the memory frequency and for recalling the offset frequency which is independently programmed in memory channels 0 ~ 9.

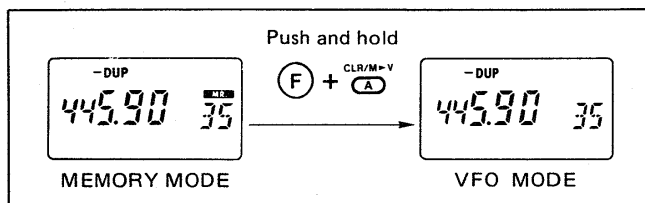

- 1) Push [B] (MR) to select MEMORY mode.
- 2) Select the memory channel to be transferred:
 - Rotate the tuning control or push [B] several times then push a digit key.
- 3) While pushing [F], push and hold [A] (CLR/M▶V) until the transceiver emits 3 beeps.
 - The memory contents are transferred into the VFO.
 - The transceiver returns to VFO mode.

6-4 Masking a memory

Unwanted memory channels can be masked (made blank). A masked memory channel cannot be selected for normal use. The contents of the masked memory can be recalled.

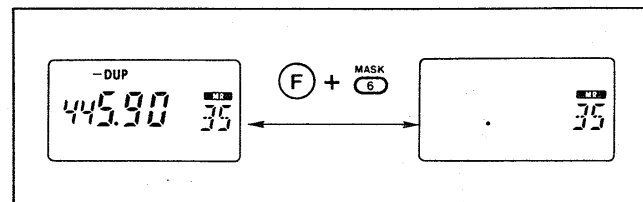

- 1) Push [B] (MR) to select MEMORY mode.
- 2) Select the memory channel in MEMORY mode to be masked:
 - Rotate the tuning control or push [B] several times then push a digit key.
- 3) While pushing [F], push [6] (MASK) to mask the displayed memory channel.
- 4) To recall the masked memory channel, repeat step 3.
- 5) Push [A] (CLR) to return to VFO mode.

7-1 Calling up the call channel

A one-touch access call channel is provided for operation on your most-often-used frequency. The call channel is separate from the memory channels.

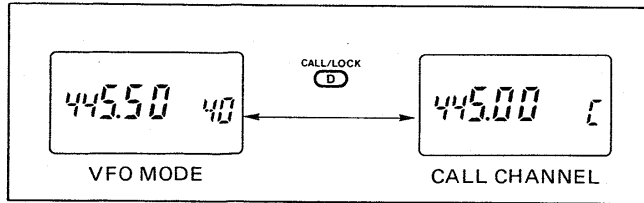

- 1) Push [D] (CALL) to call up the call channel.
- 2) Push [D] (CALL) again to return to the previous mode.

7-2 Transferring the call channel

- 1) Push [D] (CALL) to call up the call channel.
- 2) While pushing [F], push and hold [A] (CLR/M►V) to transfer the contents into the VFO.
 - VFO mode is automatically selected.

7-3 Programming the call channel

The call channel contents can be programmed in a similar way as the memory channels.

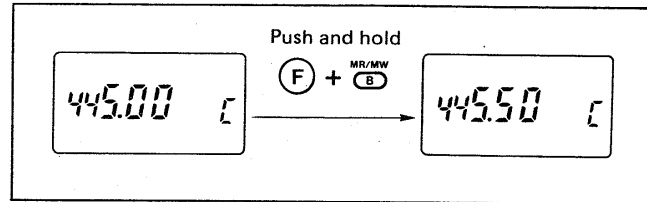

- 1) Push [A] (CLR) to select VFO mode.
- 2) Set the desired frequency (and duplex, when required) to be programmed into the call channel.
- 3) Push [D] (CALL) to call up the call channel.
- 4) While pushing [F], push and hold [B] (MR/MW) until the transceiver emits 3 beeps.
 - The displayed frequency is changed to the same as the VFO frequency.

8-1 Scan types

The IC-4SAT/SET has 3 scan types and 2 skip functions as described below. Perfect for hands-free operation.

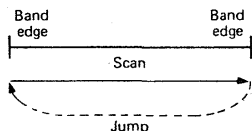
• FULL SCAN

Repeatedly scans all frequencies in the entire 430 or 440 MHz band. The frequency skip function can be used.

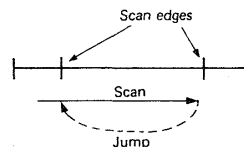
• PROGRAMMED SCAN

Repeatedly scans between two user-programmed frequencies. See p. 24 for scan edge programming. The frequency skip function can be used.

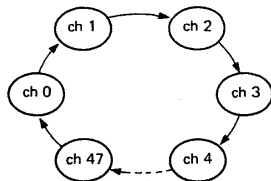
• MEMORY SCAN

Repeatedly scans all memory channels in sequence. The memory skip function can be used during memory scan.

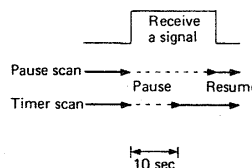
• SCAN RESUME CONDITION

2 resume conditions are available: pause and timer scan. When receiving a signal, pause scan pauses until the signal disappears; timer scan pauses for approx. 10 sec.

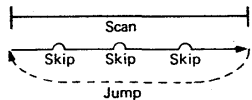
• FREQUENCY SKIP FUNCTION

Skips unwanted signals that inconveniently stop scanning. See p. 25 for programming.

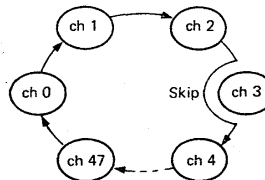
• MEMORY SKIP FUNCTION

Skip unnecessary memory channels, making shorter intervals for memory scanning. See p. 26 for programming.

8-2 Scan operation

Refer to the following table for any scan operation. However, before operating a scan, rotate the [SQUELCH] control clockwise until audio is muted.

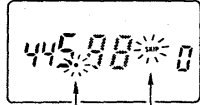
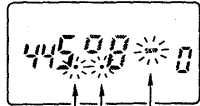
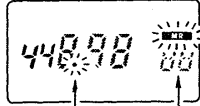
SCAN TYPE	① PRE-OPERATION	② SCAN START	③ SCAN RESUME CONDITION	④ SCAN STOP	WHILE SCANNING
FULL SCAN	Push [A] to select VFO mode.	Push and hold [*] or [#] for 1 sec.	<ul style="list-style-type: none"> • Scan resumes 10 sec. after a signal is received or 2 sec. after a signal disappears. • Tuning control rotation restarts scan and changes scan direction. • Resume condition can be selected. See p. 25 for details. 	<ul style="list-style-type: none"> • Push [*] or [#]. • [A], [B] or [D] also stop the scan, though the operating mode may be changed. 	 <p>Blinks Blinks when frequency skip is ON.</p>
PROGRAM-MED SCAN	Push [A] to select VFO mode.	While pushing [F] push [*] or [#].			 <p>Blink Blinks when frequency skip is ON.</p>
MEMORY SCAN	Push [B] to select MEMORY mode.	Push and hold [*] or [#] for 1 sec.			 <p>Blink</p>

8 SCAN OPERATION

8-3 Setting scan conditions

(1) SETTING THE PROGRAMMED SCAN EDGES USING SET MODE

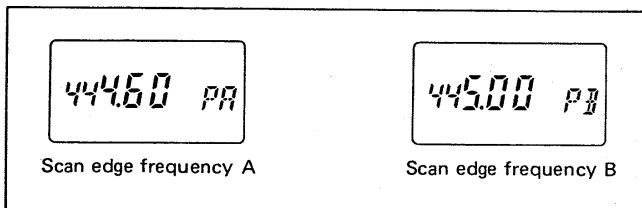

- 1) Push [A] (CLR) to select VFO mode.
- 2) While pushing [F], push [8] (SET) to enter SET mode.
 - Refer to p. 8 for SET mode details.
- 3) Push [*] (▽) or [#] (△) until "PA" appears as shown above.
- 4) Set a scan edge frequency using the keyboard or tuning control.
- 5) Push [#] (△) ("PB" appears), then set the other scan edge frequency.
- 6) Push [A] (CLR) to exit SET mode.

(2) SCAN RESUME CONDITION WITH POWER ON

The resume condition can be selected as a pause or timer scan.

- While holding the following switches, turn ON power to change the condition..

- [4] + [LIGHT] : Pause scan
(Scan pauses until signal disappears.)
- [5] + [LIGHT] : Timer scan (Scan pauses for 10 sec.)

(3) FREQUENCY SKIP FUNCTION

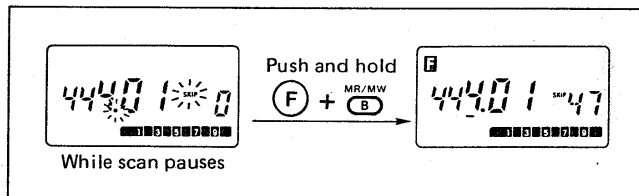

- 1) Start full scan or programmed scan. See Section 8-2 (p. 24).
- 2) To program the received frequency as a skip frequency:
 - While pushing [F], push and hold [B] (MR/MW) until the transceiver emits 3 beeps.
 - Memory channel number 47 appears for a moment.
 - The channel number decreases when programming the next frequency. Memory channels 47 ~ 10 can be used for programming.

USING SET MODE

■ FREQUENCY SKIP FUNCTION ON/OFF

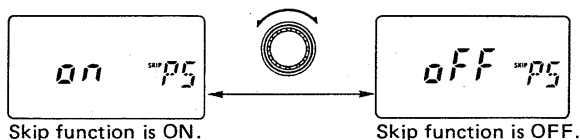

- 1) Push [A] (CLR) to select VFO mode.
- 2) While pushing [F], push [8] (SET) to enter SET mode.
 - Refer to p. 8 for SET mode details.
- 3) Push [*] (▽) or [#] (△) until "PS" appears as shown above.
- 4) Rotate the tuning control to turn ON or OFF the frequency skip function.
- 5) Push [A] (CLR) to exit SET mode.

(4) PROGRAMMING A MEMORY SKIP CHANNEL

Memory channels not desired can be skipped during memory scan. These skip channels are also skipped during priority watch (memory scan watch) and the frequencies of the channels are skipped during full or programmed scan.

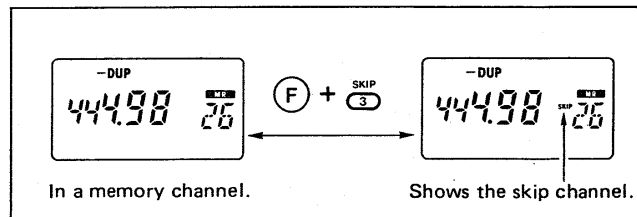

- 1) Select the memory channel to be programmed as the skip channel:
 - Push [B] (MR) then rotate the tuning control, or push [B] several times then push a digit key.
- 2) While pushing [F], push [3] (SKIP) to program.
 - "SKIP" appears.
- 3) Repeat step 2 to delete the skip function from the memory channel.

9-1 Priority watch types

• VFO ↔ MEMORY CHANNEL

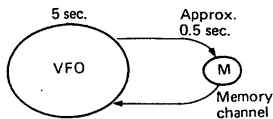

While using a VFO frequency, priority watch checks the selected memory channel in 5 sec. intervals.

Start the watch from MEMORY or VFO mode.

When the selected memory channel is masked (made blank), the watch does not start.

• VFO ↔ CALL CHANNEL

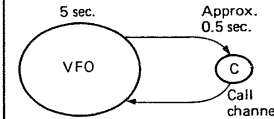

While using a VFO frequency, priority watch checks the call channel in 5 sec. intervals.

Start the watch from the call channel.

• VFO ↔ MEMORY SCAN

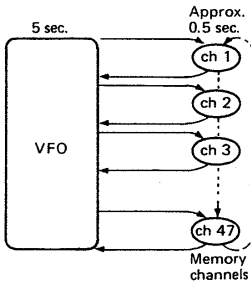

While using a VFO frequency, priority watch checks each memory channel. You can also program skip channels which will not be watched, making shorter scanning intervals.

Start the watch during memory scan.

9-2 Priority watch operation

Refer to the following table for any priority watch operation. However, before operating the watch function, rotate [SQUELCH] clockwise until audio is muted.

PRIORITY WATCH TYPE	① PRE-OPERATION	② START	③ RESUME CONDITION	④ STOP
VFO ↔ MEMORY CHANNEL	<ol style="list-style-type: none"> 1) Set the memory channel to be watched. 2) Push [A] to select VFO mode. 	While pushing [F], push [7].	<ul style="list-style-type: none"> • Priority watch pauses for 15 sec. when a signal is received on a watching channel or resumes 2 sec. after the signal disappears. • While the watch pauses, pushing [A] resumes watch manually. 	<ul style="list-style-type: none"> • While pushing [F], push [7]. • [A], [B] or [D] also stops the watch function. However, the mode may be changed.
VFO ↔ CALL CHANNEL	Push [D] to call up call channel.			
VFO ↔ MEMORY SCAN	<ol style="list-style-type: none"> 1) Push [B] to select MEMORY mode. 2) Push and hold [*] or [#] to start memory scan. 			

10 DTMF MEMORY OPERATION

10-1 Programming a DTMF code

The transceiver has 10 DTMF memory channels for storing your most-often-used DTMF codes of up to 15 digits.

- 1) While pushing [F], push [H/L/DTMF] to enter DTMF MEMORY mode.
- 2) Push a digit key to select the desired channel.
- 3) While pushing [F], push [8] (SET) to program the DTMF memory.
 - Previous programmed digits are erased.
- 4) Push the appropriate digit keys to input the DTMF code.
 - When 15 digits are input, the transceiver stores the digits automatically.

5) Push [H/L/DTMF] to store the input digits.

- 6) Push [H/L/DTMF] or [PTT] to exit DTMF MEMORY mode.
 - When [H/L/DTMF] is pushed, the transceiver emits the programmed code.

10-2 Transmitting a DTMF code

- 1) Select the desired DTMF memory channel:
 - See Section 10-1 steps 1 and 2.
- 2) Push [PTT] to exit DTMF MEMORY mode.
- 3) To transmit the DTMF code in the selected channel:
 - While pushing [PTT], push [H/L/DTMF].

EXAMPLE: Programming digits of 1234567890 into DTMF memory channel T7.

The programmed code is emitted.

11-1 Clock mode

The transceiver is equipped with a clock function for operating the power on timer and auto power off timer.

- 1) While pushing [F], push [9] (CLOCK) to enter CLOCK mode.
- 2) Push [PTT] to return to the previous mode.

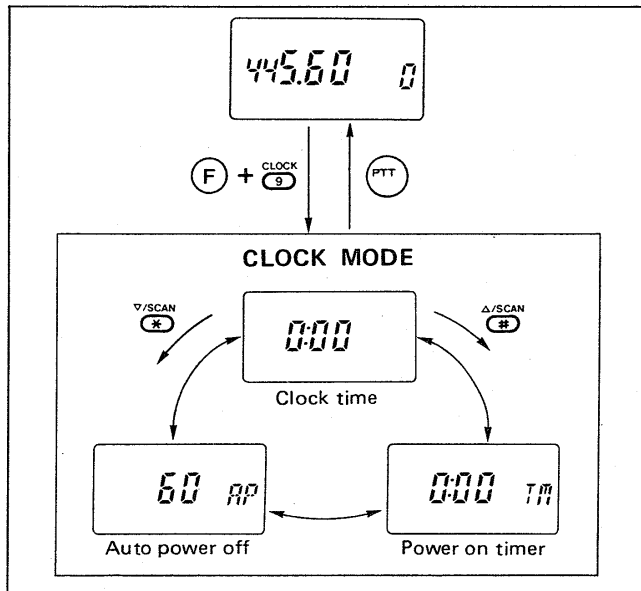

11-2 Setting time

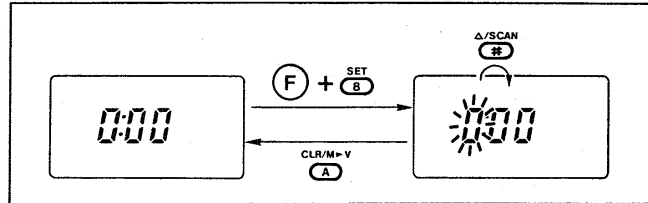

- 1) While pushing [F], push [9] (CLOCK) to enter CLOCK mode.
- 2) Push [*] (▽) or [#] (△) to select the clock time display as shown above.
- 3) While pushing [F], push [8] (SET). The displayed time blinks.
- 4) Rotate the tuning control to set the hours.
- 5) Push [*] (▽) or [#] (△), then rotate the tuning control to set the minutes.
- 6) Push [A] (CLR) to set the time.
- 7) Push [PTT] to exit CLOCK mode.

TIME ERROR: ±1 min./week

11 CLOCK AND TIMER OPERATION

11-3 Power on timer

The transceiver has a power on timer to fit your schedule and to save battery power. While the timer is activated, the transceiver is in the off condition, the function display shows the clock time and the transmitter and receiver circuits do not operate.

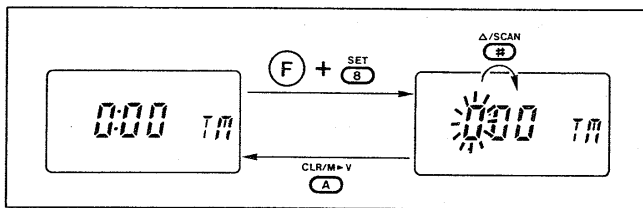

- 1) While pushing [F], push [9] (CLOCK) to enter CLOCK mode.
- 2) Set the clock time. See Section 11-2 (p. 30) steps 2 ~ 5.
- 3) Push [*] (▽) or [#] (△) until "TM" appears as shown above.
- 4) While pushing [F], push [8] (SET).
 - The displayed time blinks.
- 5) Rotate the tuning control to set the hours.

- 6) Push [*] (▽) or [#] (△), then rotate the tuning control to set the minutes.
- 7) Push [A] (CLR) to set the time.
- 8) To start the power on timer:
 - While pushing [F], push [A] (CLR).
 - The decimal point appears, indicating the power on timer is activated.
 - DO NOT turn OFF the power with the [PWR/VOL] control.

To turn ON the transceiver while in the off condition, turn OFF then ON again using the [PWR/VOL] control.

[EXAMPLE]

Setting time at 9:30 and the power on time at 15:00.

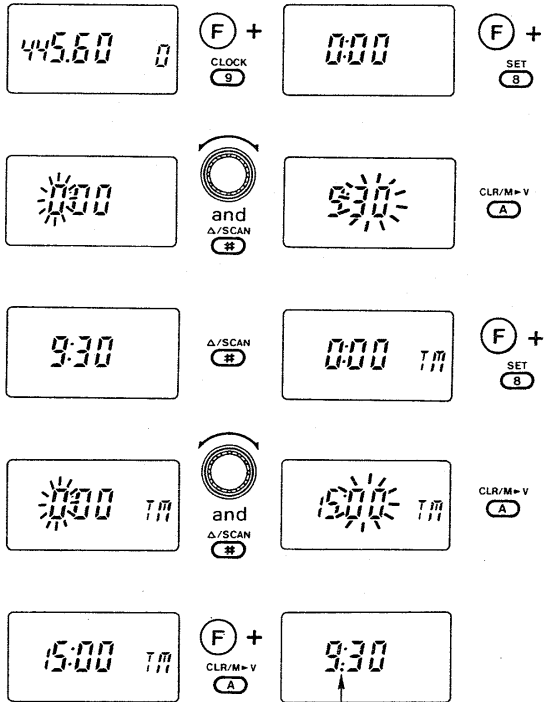

A dot appears when the power on timer is ON.

11-4 Auto power off

The transceiver automatically turns OFF after the selected time when no switch is pushed or no signal is received. Time can be set in 20, 40 and 60 min. intervals. The function can also be deactivated using the "oFF" setting.

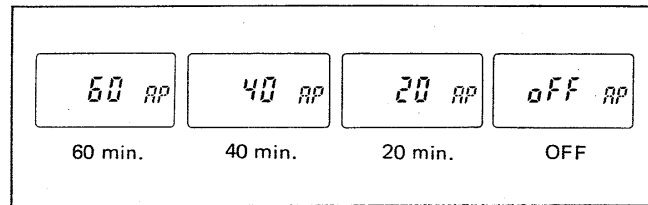

- 1) While pushing [F], push [9] (CLOCK) to enter CLOCK mode.
- 2) Push [*] (▽) or [#] (Δ) until "AP" appears as shown above.
- 3) Rotate the tuning control to set the desired time or function OFF.
- 4) Push [PTT] to exit CLOCK mode.

To turn ON the transceiver while in the off condition, turn OFF then ON again using the [PWR/VOL] control.

12 BEEP AND POWER SAVER

12-1 Beep tone ON/OFF

USING SET MODE

The transceiver emits a beep tone each time a switch is pushed. To turn OFF the beep tone, use SET mode.

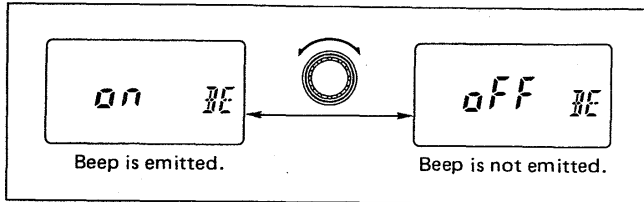

- 1) Push [A] (CLR) to set VFO mode.
- 2) While pushing [F], push [8] (SET) to enter SET mode.
 - Refer to p. 8 for SET mode details.
- 3) Push [*] (▽) or [#] (△) until "BE" appears as shown above.
- 4) Rotate the tuning control to select beep "on" or "off."
- 5) Push [A] (CLR) to exit SET mode.

12-2 Power saver function

WITH POWER ON

The power saver function reduces the current drain to conserve battery power. The function activates 5 sec. after the squelch closes or no switch is pushed.

A duty cycle of the power saver function (standby : circuit off) can be selected or turned OFF to suit your desired operation.

- 1) Turn power OFF.
- 2) While pushing the following switches, turn power ON.

SWITCHES	[7] + [LIGHT]	[8] + [LIGHT]	[9] + [LIGHT]
Standby	Power saver deactivates	125 msec.	125 msec.
Circuit off		500 msec.	approx. 2 sec.

13-1 Unit installations

(1) DISASSEMBLING THE TRANSCEIVER

1) Turn power OFF, then remove the bottom cap.

2) Unscrew the 5 screws.

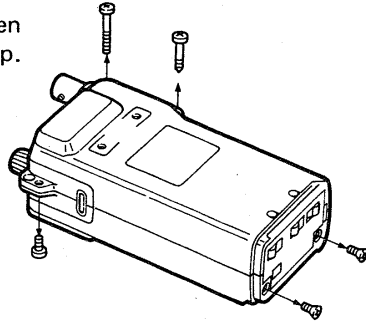

3) Open the transceiver.

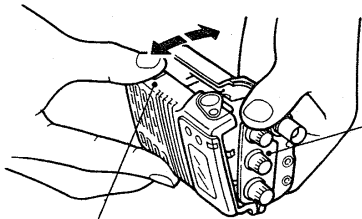

NOTE:
Keep attached to the rear panel.

CAUTION:
DO NOT lose the small spring located here.

CAUTION:
Flexible cables are fragile and can be damaged by mishandling.

(2) INSTALLATION LOCATIONS

- UT-50 TONE SQUELCH UNIT (ENCODER/DECODER)
- UT-51 PROGRAMMABLE TONE ENCODER

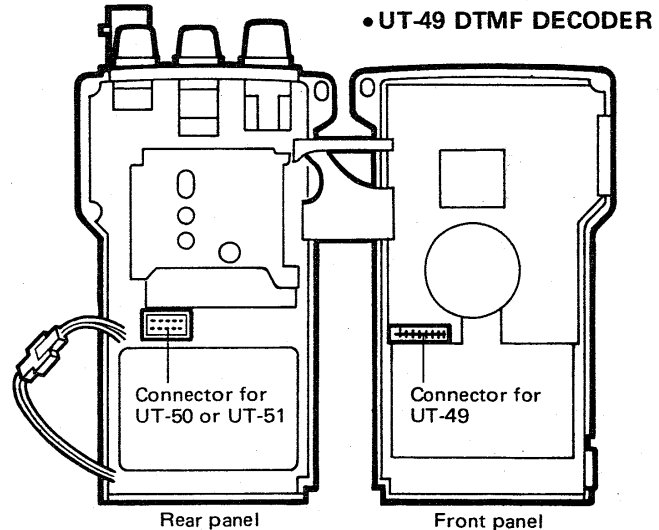

After installing the unit, reassemble the transceiver.

13 OPTIONAL UNIT OPERATION

13-2 Pager function

The pager function accesses other stations and displays a code identical to yours using the other station's display. This function can be used for group communications.

The pager function transmits a code with 7 DTMF digits: Transmit code + "*" + your ID code.

An optional UT-49 DTMF DECODER UNIT is necessary for operation.

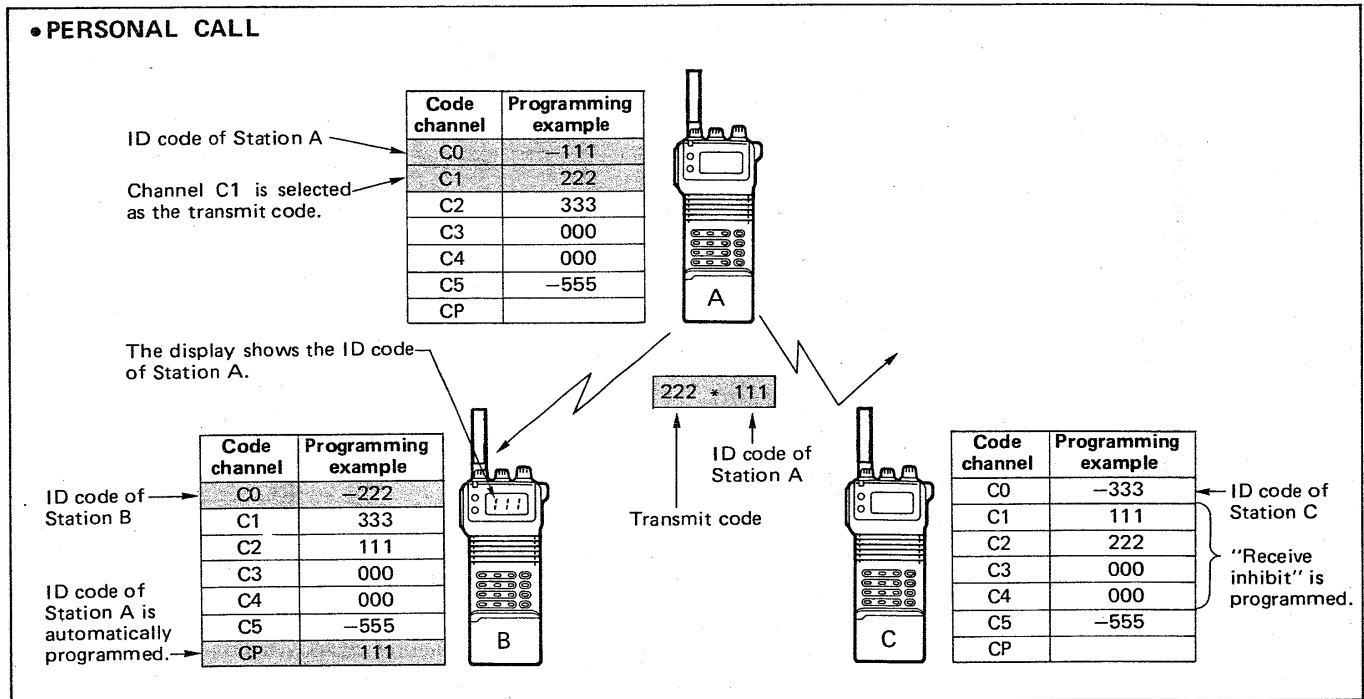

PRE-OPERATION:

- 1) Install optional UT-49 units in your group transceivers.
- 2) Decide the ID code of each transceiver and the group code in your group.
- 3) Decide whether to return to normal operation or code squelch operation after contact.
- 4) Program the ID code, group code, and the other station's ID codes as transmit codes. (p. 37)
 - Your ID code should be programmed into the code memory channel C0.
 - Program "receive inhibit" on channels programmed as transmit codes.

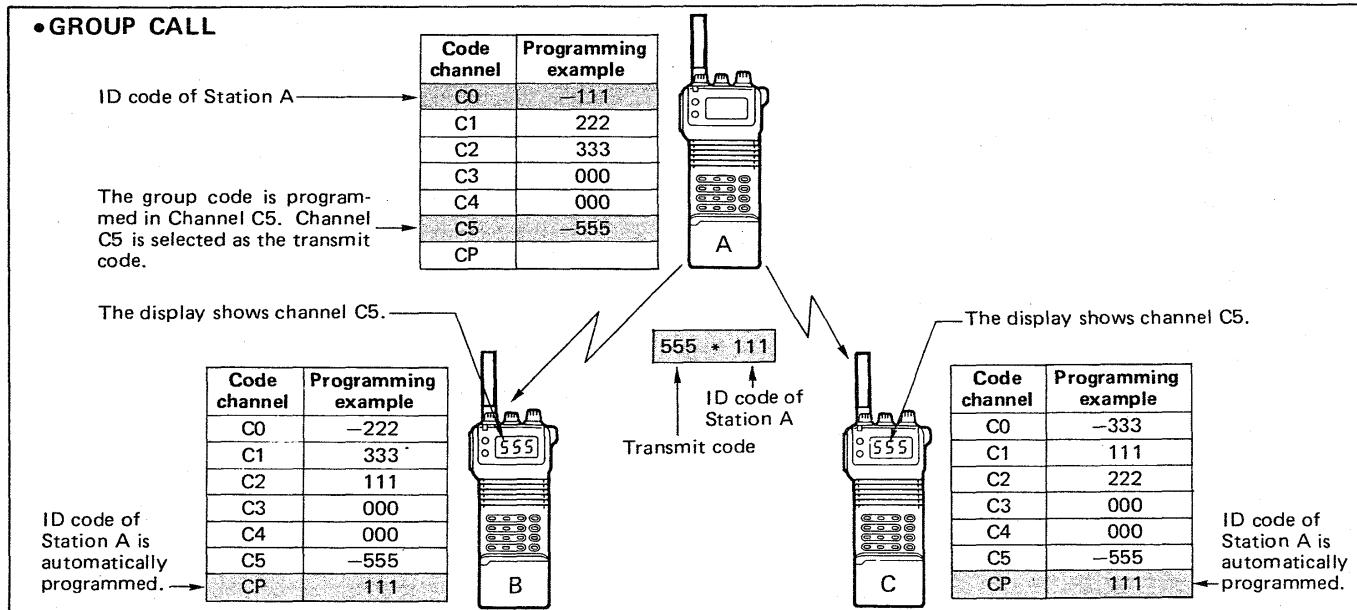

13 OPTIONAL UNIT OPERATION

(1) CODE MEMORY CHANNEL INFORMATION

CODE MEMORY CHANNEL	PURPOSE	RECEIVE ACCEPT or INHIBIT	MEMORY PROGRAMMING CAPABILITY
C0	Your ID code	Accept only	Possible
C1	Other station's ID codes	Selectable accept or inhibit	
C2	(Transmit code) or group code		
C3			
C4			
C5			
CP	Memorizing space*	Inhibit only	Not Applicable

* Automatically memorizes the ID code of the other station when receiving a call. This memory is kept until the next call is received.

(2) PROGRAMMING A CODE MEMORY

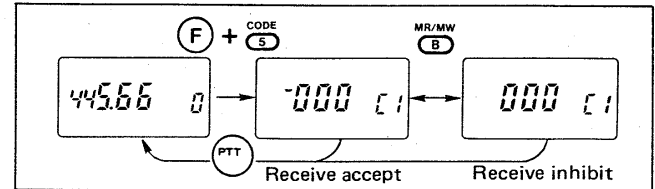

- 1) While pushing [F], push [5] (CODE) to change the display for code programming.
- 2) Rotate the tuning control to select the code memory channel to be programmed.
- 3) Push 3 digit keys to enter the desired code.
 - Channel CP does not accept entry.
- 4) Push [B] (MR) to select "receive accept" or "receive inhibit."
 - When selecting "receive accept," a dash appears in front of the digit code.
 - Channels C0 and CP do not accept selection.
- 5) Push [PTT] to return to the previous mode.

(3) PAGER OPERATION

The following operation procedures should be started after completing the steps described in PRE-OPERATION on p. 36.

■ PERSONAL CALL

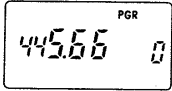
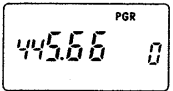
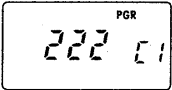
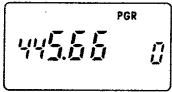
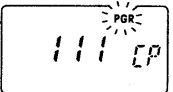
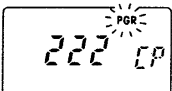
STATION A	STATION B
PRE-PROGRAM CO: ID code of "111" C1: Station B's ID code of "222"	PRE-PROGRAM CO: ID code of "222"
1) While pushing [F], push [2] (PGR/C-SQL) to turn ON the pager function. 	1) While pushing [F], push [2] (PGR/C-SQL) to turn ON the pager function. 
2) While pushing [F], push [5] (CODE). 3) Rotate the tuning control to select the channel with the programmed ID code of Station B. 	
4) Push [PTT] to return to the normal display. 5) Push [PTT] to transmit the ID code of Station B. 	2) When receiving a signal, the display shows the code channel CP that indicates the ID code of Station A. The transceiver emits beeps. 
6) When receiving a signal, the display becomes the code channel CP that shows the ID code of Station B. The transceiver emits beeps. 	3) Push [PTT]. 4) While pushing [F], push [2] (PGR/C-SQL) to select the code squelch function, or push [2] again to turn OFF the pager function.
7) Push [PTT]. 8) While pushing [F], push [2] (PGR/C-SQL) to select the code squelch function, or push [2] again to turn OFF the pager function.	
9) Operate the transceiver for normal communications.	5) Operate the transceiver for normal communications.

13 OPTIONAL UNIT OPERATION

■ GROUP CALL

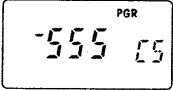
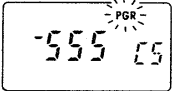
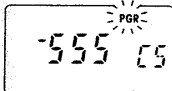
STATION A	STATION B	STATION C
PRE-PROGRAM C5: Group code of "555"	PRE-PROGRAM C5: Group code of "555"	PRE-PROGRAM C5: Group code of "555"
1) While pushing [F], push [2] (PGR/C-SQL) to turn ON the pager function.	1) While pushing [F], push [2] (PGR/C-SQL) to turn ON the pager function.	1) While pushing [F], push [2] (PGR/C-SQL) to turn ON the pager function.
2) While pushing [F], push [5] (CODE). 3) Rotate the tuning control to select the channel programmed with the group code. 		
4) Push [PTT] to return to the normal display. 5) Push [PTT] to transmit the group code.	2) When receiving a signal, the display shows the code channel programmed with the group code. The transceiver emits beeps. 	2) When receiving a signal, the display shows the code channel programmed with the group code. The transceiver emits beeps. 
6) When receiving a signal, the display shows the code channel programmed with the group code. The transceiver emits beeps.	3) Push [PTT].	3) The transceiver emits beeps.
7) Push [PTT].	4) While pushing [F], push [2] (PGR/C-SQL) to select the code squelch function, or push [2] again to turn OFF the pager function.	4) Push [PTT].
8) While pushing [F], push [2] (PGR/C-SQL) to select the code squelch function, or push [2] again to turn OFF the pager function.		5) While pushing [F], push [2] (PGR/C-SQL) to select the code squelch function, or push [2] again to turn OFF the pager function.
9) Operate the transceiver for normal communications.	5) Operate the transceiver for normal communications.	6) Operate the transceiver for normal communications.

13-3 Code squelch

The code squelch function provides you with "personalized communication" using 3 DTMF digits.

An optional UT-49 DTMF DECODER UNIT is necessary for operation.

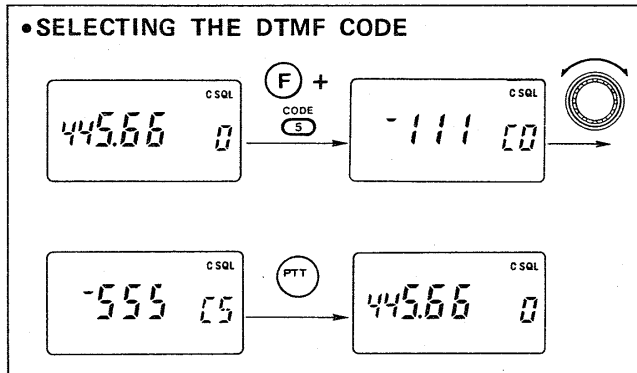
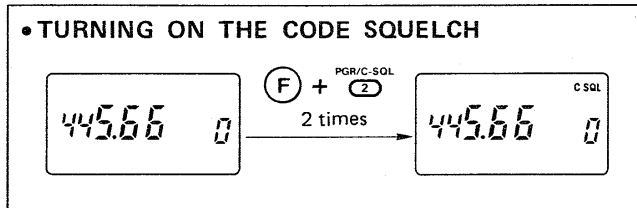

- 1) Decide the ID code on each transceiver and the group code in your group.
- 2) Program the ID code, group code, and the other station's ID codes as transmit codes. (p. 37)
 - Your ID code should be programmed into code memory channel C0.
 - Program "receive inhibit" on channels programmed with transmit codes.
- 3) While pushing [F], push [2] (PGR/C-SQL) twice to turn ON the code squelch function.
 - "C-SQL" appears.
- 4) While pushing [F], push [5] (CODE) to change the display to the code memory channel.
- 5) Rotate the tuning control to select the desired code channel to be used.
 - For personalized communications:
 - Select the programmed ID code channel of the communicating station.
 - For group communication:
 - Select the programmed group code channel.
- 6) Push [PTT] to return to the normal display.
- 7) Operate the transceiver for normal communications.

13 OPTIONAL UNIT OPERATION

13-4 Subaudible tone encoder

When a repeater requires a subaudible tone, an optional UT-50 or UT-51 unit is necessary.

- 1) While pushing [F], push [1] (T/T SQL).
 - "T" appears on the function display.
 - When the UT-50 is installed, push the switch until only "T" appears.
- 2) To set a subaudible tone frequency, see right.
- 3) To turn OFF a subaudible tone, repeat step 1 until "T" or "T SQL" disappears.

13-5 Tone squelch (CTCSS)

The tone squelch function allows you to receive only signals with the same subaudible tone as those programmed in your transceiver.

An optional UT-50 TONE SQUELCH UNIT is necessary for operation.

- 1) While pushing [F], push [1] (T/T SQL) until "T SQL" appears on the function display.
 - When only "T" appears, the subaudible tone encoder is activated.

2) To set a tone frequency, see below.

- 3) To turn OFF a subaudible tone, repeat step 1 until "T" or "T SQL" disappears.

NOTE: The tone squelch cannot be used through a repeater equipped with a tone filter.

USING SET MODE

■ SETTING A TONE FREQUENCY

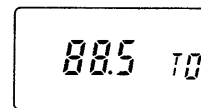

The display shows the tone frequency for 88.5 Hz.

- 1) Push [A] (CLR) to select VFO mode.
- 2) While pushing [F], push [8] (SET) to enter SET mode.
 - Refer to p. 8 for SET mode details.
- 3) Push [*] (▽) or [#] (△) until "TO" appears as shown above.
- 4) Rotate the tuning control to set the desired frequency.
- 5) Push [A] (CLR) to exit SET mode.

14-1 Troubleshooting

PROBLEM	POSSIBLE CAUSE	SOLUTION	REF.
<ul style="list-style-type: none"> No power comes on. 	<ul style="list-style-type: none"> The internal battery requires charging. The external battery pack requires charging when connected. Poor plug connection when using an external DC power cable. 	<ul style="list-style-type: none"> Charge the internal battery. Charge the battery pack. When connected the internal battery is not used. Check the connection or remove the cable. 	<p>p. 5</p> <p>p. 5</p>
<ul style="list-style-type: none"> No sound comes from the speaker. 	<ul style="list-style-type: none"> [SQUELCH] is turned too far clockwise. The internal battery or external battery pack requires charging. An external speaker or earphone is connected. The power off timer is activated. 	<ul style="list-style-type: none"> Rotate [SQUELCH] counterclockwise. Charge the battery. When connecting an external battery pack or DC cable, the internal battery is not used. Unplug the speaker or earphone. Turn power OFF and ON again. 	<p>p. 10</p> <p>p. 5</p> <p>p. 31</p>
<ul style="list-style-type: none"> No transmitting possible or only low power can be used. 	<ul style="list-style-type: none"> The internal battery or external battery pack requires charging. Low power is selected. The PTT lock function is activated. 	<ul style="list-style-type: none"> Charge the battery. When connecting an external battery pack or DC cable, the internal battery is not used. Select high output power. While pushing [*] and [LIGHT], turn power ON. 	<p>p. 5</p> <p>p. 16</p> <p>p. 17</p>
<ul style="list-style-type: none"> Frequency cannot be set. 	<ul style="list-style-type: none"> The lock function is activated. The call channel is selected. The power off timer is activated. 	<ul style="list-style-type: none"> Turn OFF the function. Push [A] to select VFO mode. Turn power OFF and ON again. 	<p>p. 15</p> <p>p. 22</p> <p>p. 32</p>
<ul style="list-style-type: none"> The receive indicator does not light when squelch opens. 	<ul style="list-style-type: none"> The receive indicator has been set in the OFF condition. 	<ul style="list-style-type: none"> While pushing [F], push [MONI]. 	<p>p. 16</p>
<ul style="list-style-type: none"> The contents of the memories are erased. 	<ul style="list-style-type: none"> The backup battery is exhausted because no charging has been performed for a long time. 	<ul style="list-style-type: none"> Charge the internal battery (backup battery is charged simultaneously). 	<p>p. 5</p>

14 MAINTENANCE

14-2 Backup battery

The transceiver is equipped with a rechargeable lithium backup battery for retaining memory information.

NOTE: If the transceiver is not used within 1 week after the internal battery is exhausted, the capacity of the lithium backup battery may be exhausted and memory information erased. At this time, reset the transceiver. See the inside of front cover for reset information.

CAUTION: Disconnect the DC power cable or an empty battery pack when not using the transceiver. If these remain connected, the internal battery cannot be used to charge the lithium battery.

14-3 Cleaning

If the transceiver becomes dusty or dirty, wipe it clean with a dry, soft cloth.

AVOID the use of chemical agents such as benzine or alcohol, as they can damage transceiver surfaces.

■ GENERAL

- Frequency coverage : 440 ~ 450 MHz (U.S.A. version)
430 ~ 440 MHz (Other versions)
- Mode : FM (F3)
- Antenna impedance : 50 Ω unbalanced
- Acceptable external power source : 6 ~ 16V DC negative ground or battery packs BP-81 ~ 85, BP-90
- Current drain : Transmit
(At 13.8 V DC ; typical) High 1.8 A
Low 950 mA
Receive
Max. audio 250 mA
Power saved 19 mA (Average)
- Usable temperature range : $-10^{\circ}\text{C} \sim +60^{\circ}\text{C}$ ($+14^{\circ}\text{F} \sim +140^{\circ}\text{F}$)
- Dimensions : 49(W) x 102.5(H) x 35(D) mm
1.9(W) x 4.1(H) x 1.4(D) in
Projections not included
- Weight : 280 g (9.9 oz)

■ TRANSMITTER

- Output power : High More than 5.0 W
Low 3.5/1.5/0.5 W (selectable)
(at 13.8 V DC)
- Modulation system : Variable reactance frequency modulation
- Max. frequency deviation : ± 5 kHz
- Spurious emissions : Less than -60 dB
- Microphone impedance : 2 k Ω
- Duty cycle : 1:3 (min) (Transmit : Receive)

■ RECEIVER

- Receive system : Double-conversion superheterodyne
- Intermediate frequency : 1st 30.875 MHz 2nd 455 kHz
- Sensitivity : Less than 0.18 μV for 12 dB SINAD
- Squelch threshold sensitivity : Less than 0.1 μV
- Selectivity : More than 15 kHz/ -6 dB
Less than 30 kHz/ -60 dB
- Spurious rejection ratio : More than 60 dB
- Audio output power : More than 200 mW at 10 % distortion with an 8 Ω load

All stated specifications are subject to change without notice or obligation.

Count on us!

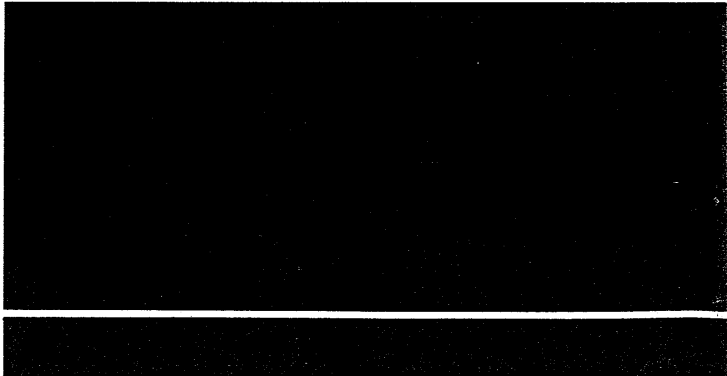

A-5077S-1EX-①
Printed in Japan
Copyright © 1989 by Icom Inc.

Icom Inc.
6-9-16, Kamihigashi, Hirano-ku, Osaka 547, Japan