



SERVICE MANUAL

DUAL BAND FM TRANSCEIVER
IC-2725E

INTRODUCTION

This service manual describes the latest service information for the **IC-2725E** DUAL BAND FM TRANSCEIVER at the time of publication

MODEL	VERSION	SYMBOL
IC-2725E	Europe	EUR
	Italy	ITR

To upgrade quality, any electrical or mechanical parts and internal circuits are subject to change without notice or obligation.

DANGER

NEVER connect the transceiver to an AC outlet or to a DC power supply that uses more than 16 V. This will ruin the transceiver.

DO NOT expose the transceiver to rain, snow or any liquids.

DO NOT reverse the polarities of the power supply when connecting the transceiver.

DO NOT apply an RF signal of more than 20 dBm (100 mW) to the antenna connector. This could damage the transceiver's front end.



ORDERING PARTS

Be sure to include the following four points when ordering replacement parts:

1. 10-digit order numbers
2. Component part number and name
3. Equipment model name and unit name
4. Quantity required

<SAMPLE ORDER>

1110004310 S.IC M62352GP IC-2725E MAIN UNIT 5 pieces
8810009610 Screw FH M2.6×6 ZK IC-2725E bottom cover 10 pieces
Addresses are provided on the inside back cover for your convenience.

REPAIR NOTES

1. Make sure a problem is internal before disassembling the transceiver.
2. **DO NOT** open the transceiver until the transceiver is disconnected from its power source.
3. **DO NOT** force any of the variable components. Turn them slowly and smoothly.
4. **DO NOT** short any circuits or electronic parts. An insulated tuning tool **MUST** be used for all adjustments.
5. **DO NOT** keep power ON for a long time when the transceiver is defective.
6. **DO NOT** transmit power into a signal generator or a sweep generator.
7. **ALWAYS** connect a 50 dB to 60 dB attenuator between the transceiver and a deviation meter or spectrum analyzer when using such test equipment.
8. **READ** the instructions of test equipment thoroughly before connecting equipment to the transceiver.

TABLE OF CONTENTS

SECTION 1	SPECIFICATIONS	
SECTION 2	INSIDE VIEWS	
SECTION 3	DISASSEMBLY INSTRUCTIONS	
SECTION 4	CIRCUIT DESCRIPTION	
4 - 1	RECEIVER CIRCUITS	4 - 1
4 - 2	TRANSMITTER CIRCUITS	4 - 5
4 - 3	PLL CIRCUITS	4 - 6
4 - 4	POWER SUPPLY CIRCUITS	4 - 8
4 - 5	PORT ALLOCATIONS	4 - 10
SECTION 5	PARTS LIST	
SECTION 6	MECHANICAL PARTS AND DISASSEMBLY	
SECTION 7	SEMI-CONDUCTOR INFORMATION	
SECTION 8	BOARD LAYOUTS	
8 - 1	CONTROL UNIT	8 - 1
8 - 2	MAIN UNIT	8 - 3
8 - 3	VCO UNIT	8 - 5
SECTION 9	BLOCK DIAGRAM	
SECTION 10	VOLTAGE DIAGRAMS	
10 - 1	CONTROL UNIT	10 - 1
10 - 2	MAIN AND VCO UNITS	10 - 2

SECTION 1 SPECIFICATIONS

■ GENERAL

- Frequency range :

VERSION	RX (MHz)	TX (MHz)
[EUR]	144.000–146.000, 430.000–440.000	144.000–146.000, 430.000–440.000
[ITR]	144.000–146.000 430.000–434.000, 435.000–438.000	144.000–146.000 430.000–434.000, 435.000–438.000

- Mode : FM, AM (AM range is 118.0 – 135.995 MHz and Rx only for [USA] and [EXP].)
- Number of memory channel : 212 (including 2 call channels and 10 scan edges)
- Usable temperature range : –10°C to +60°C; +14°F to +140°F
- Frequency resolution : 5, 10, 12.5, 15, 20, 25, 30 and 50 kHz
- Frequency stability : ±10 ppm (–10°C to +60°C; +14°F to +140°F)
- Power supply requirement : 13.8 V DC ±15 % (negative ground)
- Current drain (at 13.8 V DC) :

Receive	Standby (squelched)	1.2 A
	Max. audio output	1.8 A
Transmit	at VHF 50 W/UHF 35 W	12.0 A/11.0 A
- Antenna connector : SO-239 (50 Ω)
- DATA connector : Mini DIN 6 pin
- Dimensions :

Controller	140(W)×50(H)×27(D) mm; 5½(W)×1¾(H)×1¼(D) inch
Main unit	140(W)×40(H)×187(D) mm; 5½(W)×1¾(H)×7¾(D) inch

 (projections not included)
- Weight :

Controller	150 g; 5.29 oz
Main unit	1.4 kg; 3.0 lb

■ TRANSMITTER

- Output power :

VHF	50 W/25 W/5 W (selectable)
UHF	35 W/25 W/5 W (selectable)
- Modulation system : Variable reactance frequency
- Maximum frequency deviation : ±5.0 kHz
- Spurious emissions : Less than –60 dB
- Microphone connector : 8-pin modular jack (600 Ω)

■ RECEIVER

- Receive system : Double-conversion superheterodyne
- Intermediate frequency :

1st IF	38.85 MHz/46.05 MHz
2nd IF	450 kHz/455 kHz

 (Left/right side band)
- Sensitivity : Less than 0.18 μV (at 12 dB SINAD)
- Squelch sensitivity : Less than 0.13 μV (at threshold)
- Selectivity (wide/narrow) :

More than 12 kHz/–6 dB
Less than 30 kHz/ –60 dB
- Spurious and image rejection : More than 60 dB
- Audio output power (at 13.8 V) : More than 2.4 W at 10% distortion with an 8 Ω load
- External speaker connector : 2-conductor 3.5(d) mm (1/8")/8 Ω

All stated specifications are subject to change without notice or obligation.

SECTION 2 INSIDE VIEWS

• CONTROL UNIT (TOP VIEW)

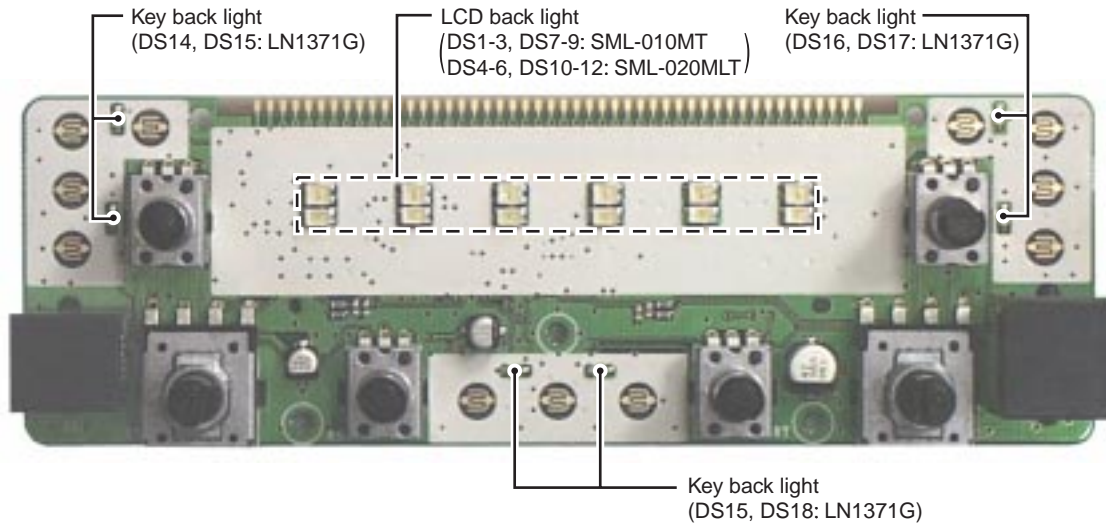

• MAIN UNIT (TOP VIEW)

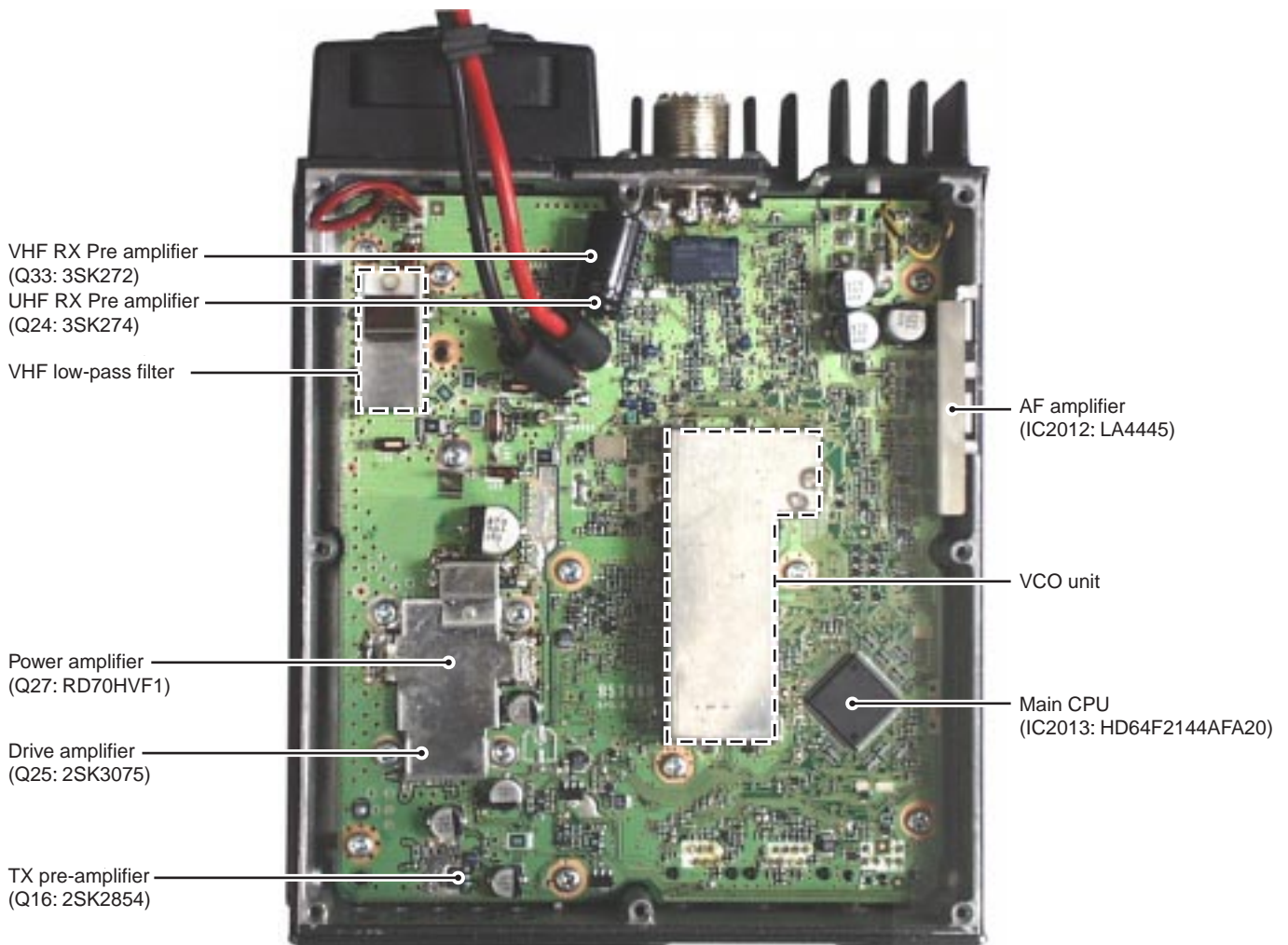

• CONTROL UNIT (BOTTOM VIEW)

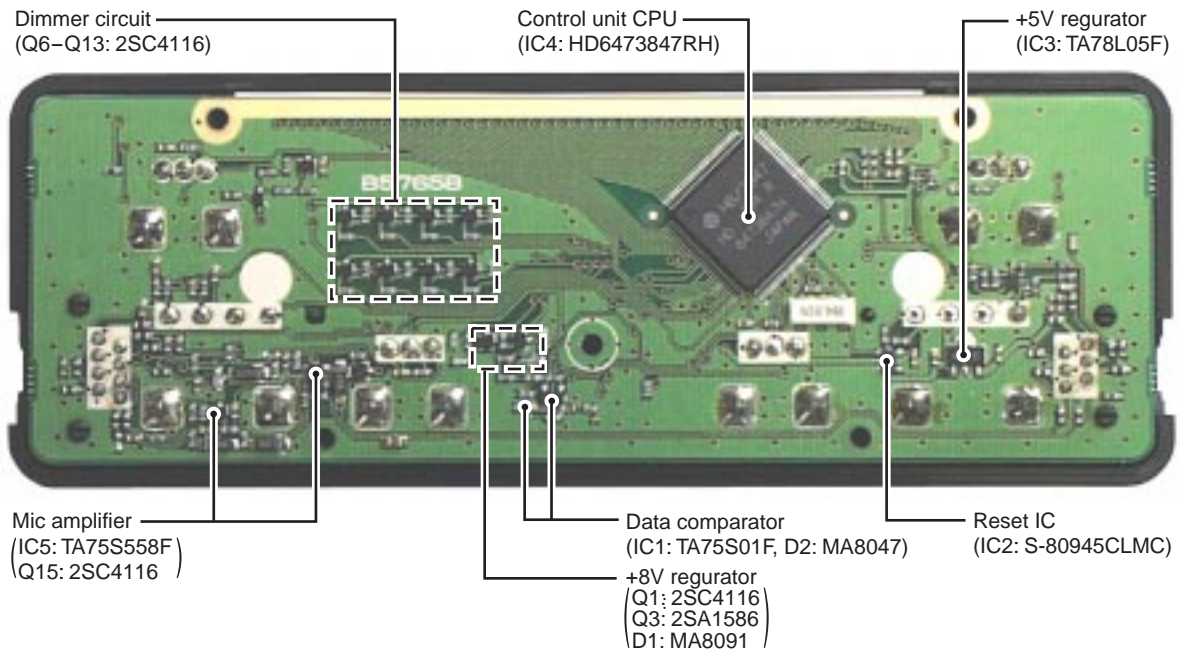

• MAIN UNIT (BOTTOM VIEW)

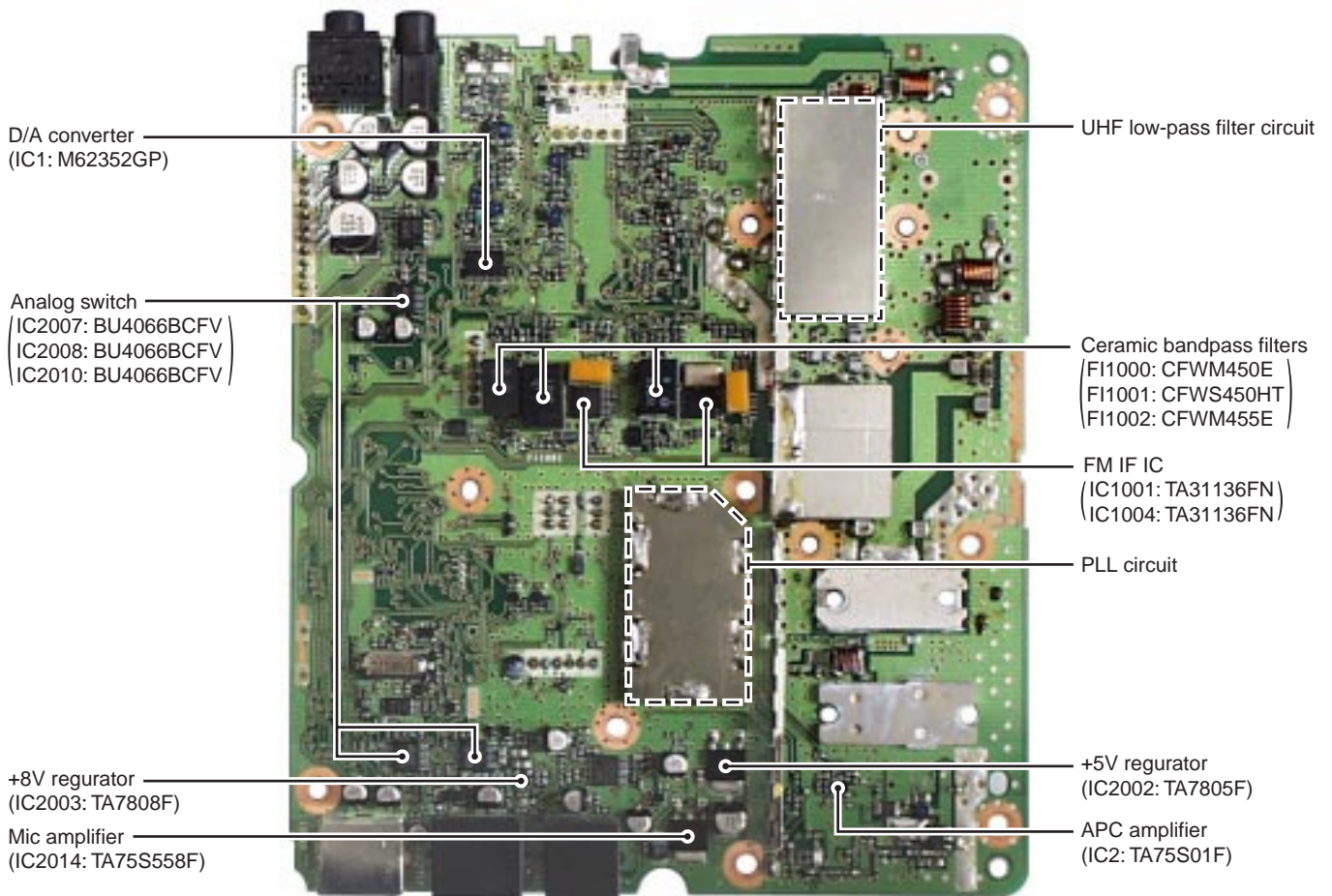

SECTION 3 DISASSEMBLY INSTRUCTIONS

• Removing the MAIN unit

- ① Unscrew 8 screws (A), and remove the cover.
- ② Disconnect two cables (B) from J1 and J2007.
- ③ Remove the clip (C).

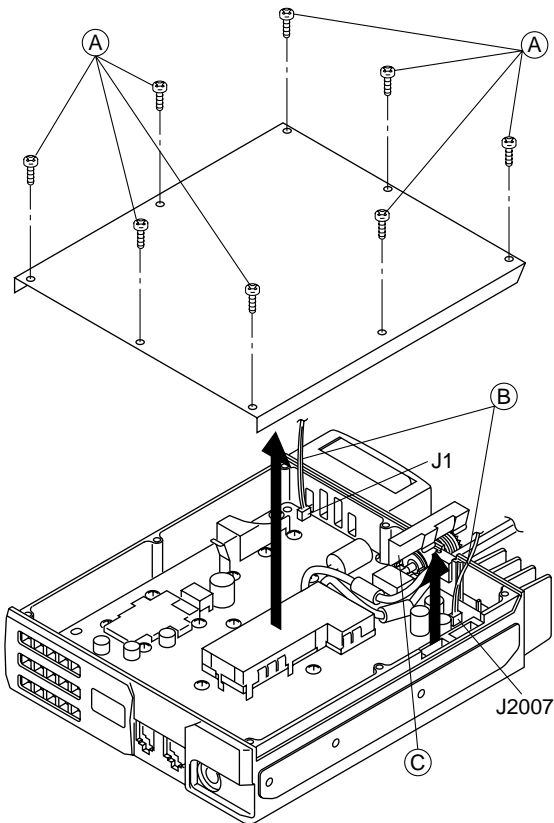

- ⑦ Unscrew 2 screws (I).
- ⑧ Unscrew 12 screws (J), and remove MAIN unit.

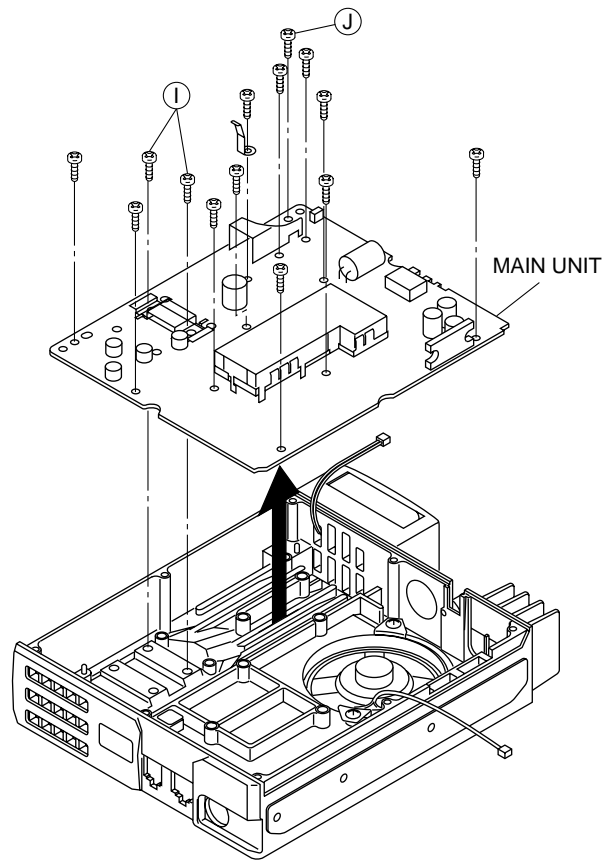

- ④ Unsolder 3 points (E).
- ⑤ Unscrew 4 screws (F).
- ⑥ Unsolder 4 points (G), and remove the cover (H).

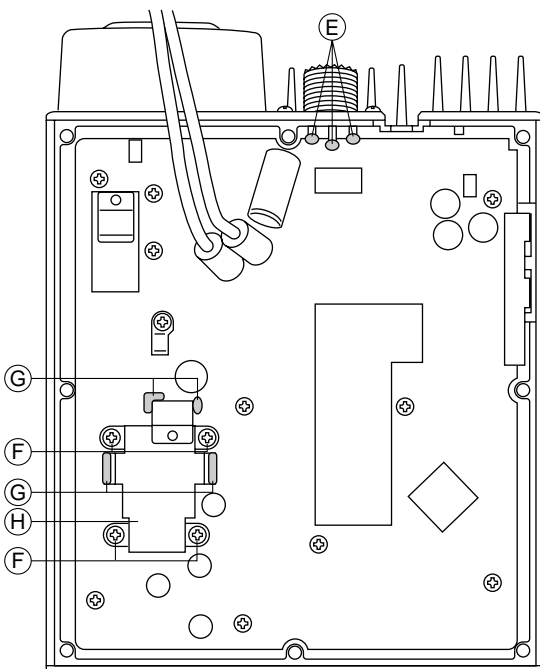

• **Removing the CONTROL unit**

① Remove 6 knobs (A).

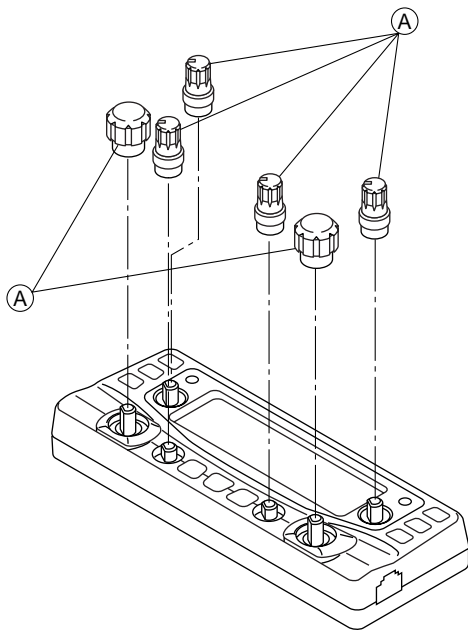

② Unscrew 4 screws (B), and remove the cover.

③ Remove the plate (C), and remove CONTROL unit.

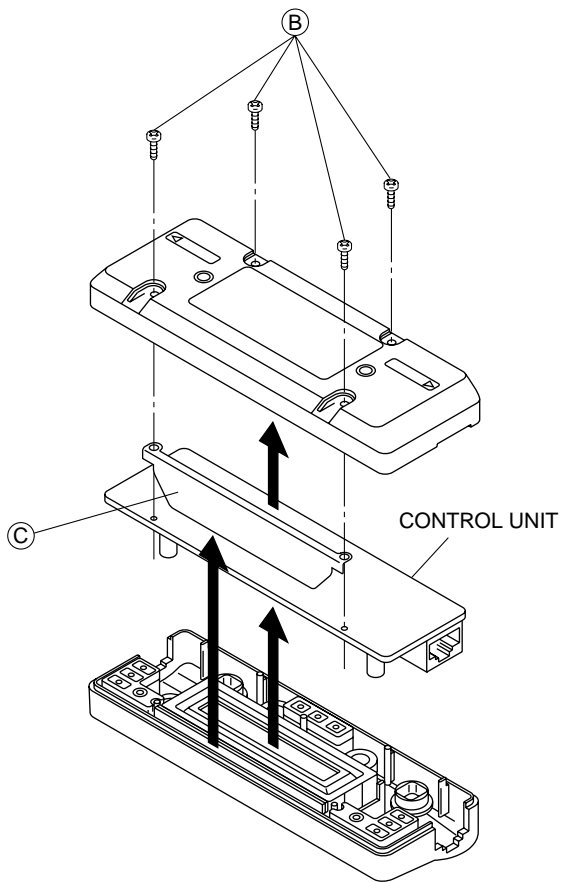

SECTION 4 CIRCUIT DESCRIPTION

4-1 RECEIVER CIRCUITS

4-1-1 TRIPLEXER AND RX BAND SWITCHING CIRCUITS (MAIN UNIT)

The transceiver has a triplexer (low-pass and high-pass filters) on the first stage from the antenna connector to separate the signals into VHF and UHF signals. The RF signals from the antenna connector are applied to the triplexer or RX band switch circuits.

• RF SIGNALS V-V (118 MHz–180 MHz), U-V (136 MHz–174 MHz)

The V-V and U-V RF signals from the antenna connector pass through the low-pass filter (L76, L77, L80, C205, C209, C242, C243, C264), and then applied to the TX/RX switching circuit (D42, D46, D52, D67, D2049). The filtered signals are amplified at the pre-amplifier (Q33), and are applied to the left side or right side displayed RX circuits.

• RF SIGNALS U-U, V-U2 (375 MHz–550 MHz)

The U-U and V-U2 RF signals from the antenna connector pass through the high-pass filter (L78, L81, C206, C210, C213, C265), and then applied to the TX/RX switching circuit (D55, D64, D65, D2050) via the SWR detector (D50, D58). The filtered signals are amplified at the pre-amplifier (Q24), and are applied to the left side or right side displayed RX circuits.

• RF SIGNALS U-U3 (810 MHz–1000 MHz)

The U-U3 RF signals from the antenna connector pass through the two low-pass filters (L76, L77, L80, C205, C209, C242, C243, C264, L87, L88, C266–C268), and are then applied to the RX band switching circuit (D2061). The filtered signals are amplified at the RF amplifier (Q18), and are applied to the right side displayed RX circuits.

• RF SIGNALS V220 (174 MHz–260 MHz), V-U1 (225 MHz–375 MHz)

The V220 and V-U1 RF signals from the antenna connector are applied to the RX band switching circuit (Q34, D66, RL1), and are applied to the left side displayed RX circuit.

4-1-2 RF CIRCUIT FOR LEFT SIDE DISPLAY (MAIN UNIT)

• RF SIGNALS V-V (118 MHz–180 MHz)

The amplified signals are applied to the RF amplifier (Q29) after being passed through the attenuator (D59) and band-pass filter (D47, D53). The signals are applied to the RX band switching circuit (D28) via the another bandpass filter (D32, D39) to suppress the unwanted signals.

• RF SIGNALS V220 (174 MHz–260 MHz)

The signals are applied to the RF amplifier (Q31) after being passed through the RX band switching circuit (D62) and bandpass filter (D51). The amplified signals are applied to the RX band switching circuit (D28) via the another bandpass filter (D34) to suppress the unwanted signals and attenuator (R195–R197).

• RF SIGNALS V-U1 (225 MHz–375 MHz)

The signals are applied to the RF amplifier (Q32) after being passed through the RX band switching circuit (D63) and bandpass filter (D49). The amplified signals are applied to the RX band switching circuit (D31) via the attenuator (R198–R200) and another bandpass filter (D35) to suppress the unwanted signals.

• RF CIRCUIT FOR LEFT SIDE DISPLAY

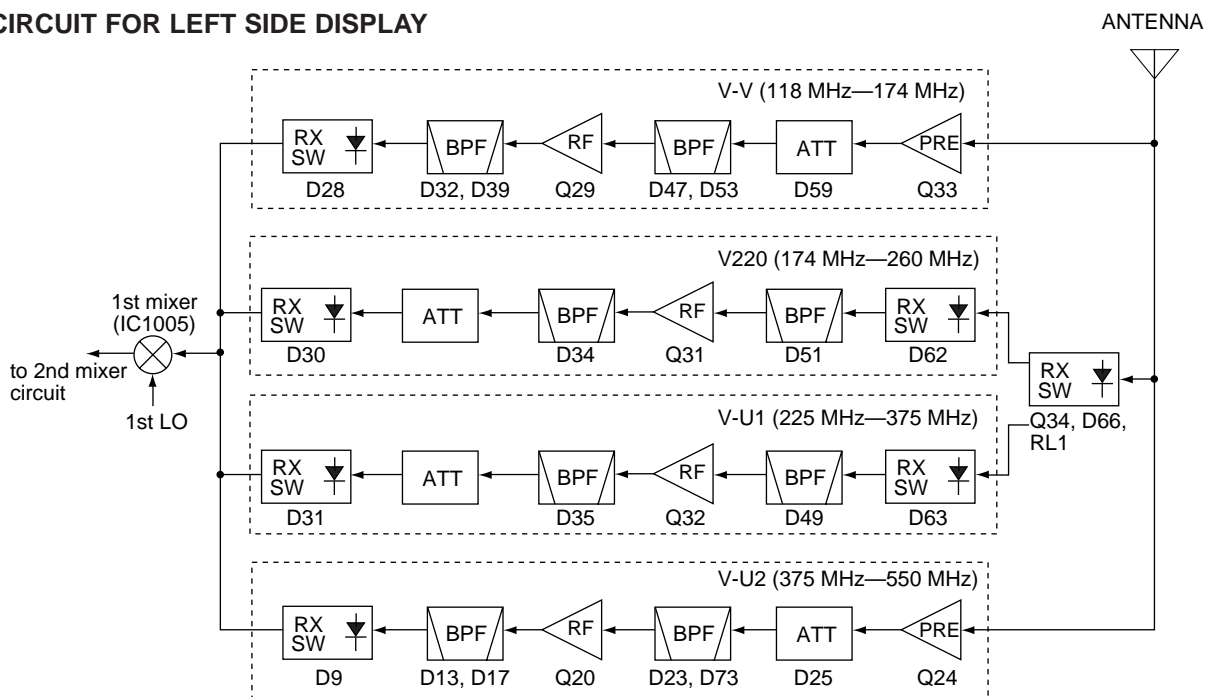

• RF SIGNALS V-U2 (375 MHz–550 MHz)

The amplified signals are applied to the RF amplifier (Q20) after being passed through the attenuator (D25) and band-pass filter (D23, D73). The signals are applied to the RX band switching circuit (D9) via the another bandpass filter (D13, D17) to suppress the unwanted signals.

The signals from the RX band switching circuits are then applied to the left side displayed 1st mixer circuit (IC1005, pin 6).

4-1-3 1ST MIXER AND 1ST IF CIRCUIT FOR LEFT SIDE DISPLAY (MAIN UNIT)

The 1st mixer circuit converts the received RF signals to a fixed frequency of the 1st IF signal with a PLL output frequency. By changing the PLL frequency, only the desired frequency will pass through the bandpass filter at the next stage of 1st mixer circuit.

The RF signals are mixed with 1st LO signals at the 1st mixer (IC1005) to produce a 38.85 MHz 1st IF signal. The 1st IF signal is output from pin 1, and passed through the crystal bandpass filter (F11003) to suppress unwanted harmonic components. The filtered signal is amplified at the IF amplifier (Q1040) after being passed through the limiter circuit (D1021). The amplified signal is applied to the 2nd mixer circuit (IC1001).

4-1-4 2ND IF AND DEMODULATOR CIRCUITS FOR LEFT SIDE DISPLAY (MAIN UNIT)

The 2nd mixer circuit converts the 1st IF signal to a 2nd IF signal. A double conversion superheterodyne system (which converts receive signal twice) improves the image rejection ratio and obtains stable receiver gain.

The FM IC IC (IC1001) contains the 2nd mixer, limiter and noise amplifiers, quadrature detector, S-meter detector, active filter circuits, etc. A 2nd LO signal (38.4 MHz) is produced at the PLL circuit by dividing its reference frequency.

The 38.85 MHz 1st IF signal from the IF amplifier (Q1040) is applied to the 2nd mixer section of the FM IF IC (IC1001, pin 16), and is mixed with the 2nd LO signal (38.4 MHz) to be converted to a 450 kHz 2nd IF signal.

The 2nd IF signal is applied to the each demodulator circuits by AM or FM mode.

• FM MODE

The 2nd IF signal is output from the FM IF IC (IC1001, pin 3) and passes through the ceramic bandpass filter (F11001). The filtered signal is fed back to the IC, and amplified at the limiter amplifier section (pin 5), then demodulated into AF signals at the quadrature detector section (pins 10, 11). The detected AF signals are output from pin 9 and are applied to the AF circuit via the AM/FM selector circuit (IC2015, pins 7, 1).

• AM MODE

The 2nd IF signal is output from the FM IF IC (IC1001, pin 3) and passes through the ceramic bandpass filter (F11000). The filtered signal is applied to the AM detector circuit (Q1017) to convert into AF signals, and then amplified at the Q1014 (pins 5, 1). The amplified AF signals are applied to the AF circuit via the AM/FM selector circuit (IC2015, pins 6, 1).

4-1-5 AF AMPLIFIER CIRCUIT FOR LEFT SIDE DISPLAY (MAIN UNIT)

The AF amplifier circuit amplifies the demodulated AF signals to drive a speaker.

The AF signals pass through the AF mute switch (Q1010), and are then applied to the electric volume control circuit (IC2011, pin 1) as "VAFO" signal after being passed through the low-pass filter (Q1007). The level controlled AF signals are output from pin 2, and are then applied to the AF power amplifier (IC2012, pin 2) via the "VOUT1" signal. The power amplified AF signals are applied to the internal speaker (SP1) via the [EXT SP] jack (J2005).

The electronic volume control circuit controls AF gain, therefore, the AF output level is according to the [VOL] setting and also the squelch conditions.

• 2ND IF AND DEMODULATOR CIRCUIT FOR LEFT SIDE DISPLAY

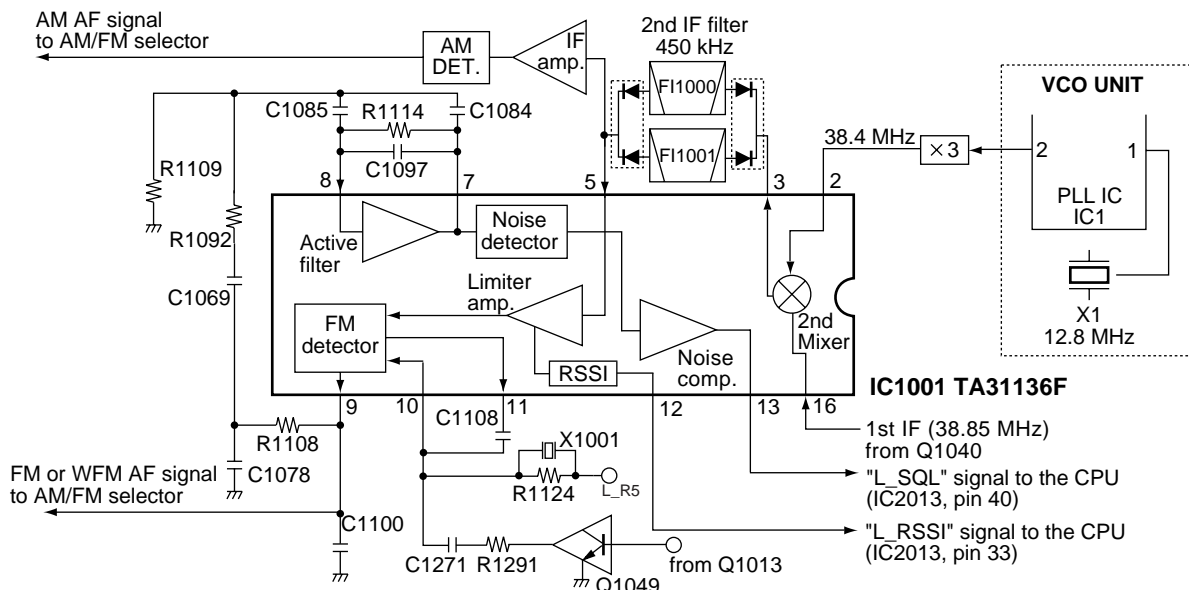

4-1-6 NOISE SQUELCH CIRCUIT FOR LEFT SIDE DISPLAY (MAIN UNIT)

• NOISE SQUELCH

A noise squelch circuit cuts out AF signals when no RF signal is received. By detecting noise components in the AF signal, the squelch circuit switches the AF mute switch.

A portion of the AF signals from the FM IF IC (IC1001, pin 9) are applied to the active filter section (IC1001, pin 8). The active filter section amplifies and filters noise components. The filtered signals are applied to the noise detector section and output from the IC1001 (pin 14) as the "L_SQL" signal. The "L_SQL" signal from IC1001 (pin 14) is applied to the CPU (IC2013, pin 40). The CPU analyzes the noise condition and outputs the "L_DET_MUTE" signal to the AF mute switch (Q1010).

• TONE SQUELCH

The tone squelch circuit detects AF signals and opens the squelch only when receiving a signal containing a matching subaudible tone (CTCSS). When tone squelch is in use, and a signal with a mismatched or no subaudible tone is received, the tone squelch circuit mutes the AF signals even when noise squelch is open.

A portion of the AF signals from the FM IF IC (IC1001, pin 9) passes through the low-pass filter (Q1003) to remove AF (voice) signals. The filtered signal is applied to the CTCSS decoder which is inside the CPU (IC2013, pin 41) via the "L_DTCS_IN" line to control the AF mute switch (Q1010).

4-1-7 RF CIRCUIT FOR RIGHT SIDE DISPLAY (MAIN UNIT)

• RF SIGNALS U-V (136 MHz–174 MHz)

The amplified signals are applied to the RF amplifier (Q30) after being passed through the attenuator (D60) and band-pass filter (D48, D54). The signals are applied to the RX band switching circuit (D29) via the another bandpass filter (D33, D40) to suppress the unwanted signals.

• RF SIGNALS U-U3 (810 MHz–1000 MHz)

The signals are applied to the RF amplifier (Q18) after being passed through the RX band switching circuit (D2061). The amplified signals pass through the attenuator (L19, C20, C46, C51, R178–R180) and high-pass filter (L20, C278, C279), and are then applied to the another RF amplifier (Q35) again. The signals pass through the attenuator (L10, C15, C280, R183–R185) and RX band switching circuit (D11).

• RF SIGNALS V-U2 (375 MHz–550 MHz)

The amplified signals are applied to the RF amplifier (Q19) after being passed through the attenuator (D24) and band-pass filter (D22, D72). The signals are applied to the RX band switching circuit (D8) via the another bandpass filter (D12, D16) to suppress the unwanted signals.

The signals from the RX band switching circuits are then applied to the right side displayed 1st mixer circuit (IC1006, pin 6).

4-1-8 1ST MIXER AND 1ST IF CIRCUIT FOR RIGHT SIDE DISPLAY (MAIN UNIT)

The 1st mixer circuit converts the received RF signals to a fixed frequency of the 1st IF signal with a PLL output frequency. By changing the PLL frequency, only the desired frequency will pass through the bandpass filter at the next stage of 1st mixer circuit.

The RF signals are mixed with 1st LO signals at the 1st mixer (IC1006) to produce a 46.05 MHz 1st IF signal. The 1st IF signal is output from pin 1, and passed through the crystal bandpass filter (F11004) to suppress unwanted harmonic components. The filtered signal is amplified at the IF amplifier (Q1041) after being passed through the limiter circuit (D1022). The amplified signal is applied to the 2nd mixer circuit (IC1004).

• RF CIRCUIT FOR RIGHT SIDE DISPLAY

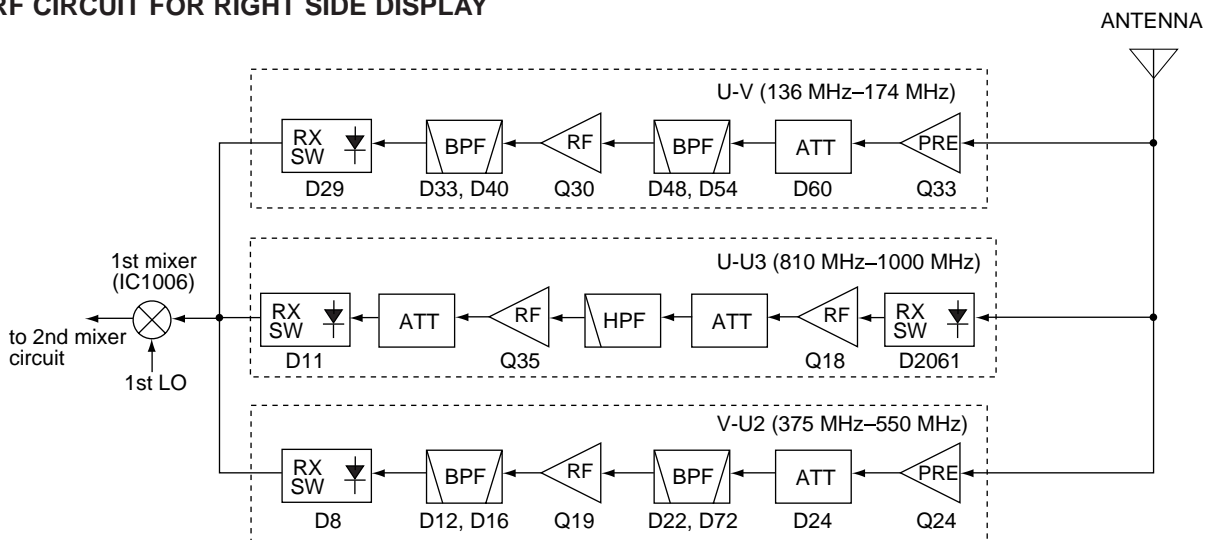

4-1-9 2ND IF AND DEMODULATOR CIRCUITS FOR RIGHT SIDE DISPLAY (MAIN UNIT)

The 2nd mixer circuit converts the 1st IF signal to a 2nd IF signal. A double conversion superheterodyne system (which converts receive signal twice) improves the image rejection ratio and obtains stable receiver gain.

The FM IC IC (IC1004) contains the 2nd mixer, limiter and noise amplifiers, quadrature detector, S-meter detector, active filter circuits, etc. A 2nd LO signal (45.595 MHz) is produced at the PLL circuit by dividing it's reference frequency.

The 46.05 MHz 1st IF signal from the IF amplifier (Q1041) is applied to the 2nd mixer section of the FM IF IC (IC1004, pin 16), and is mixed with the 2nd LO signal (45.595 MHz) to be converted to a 455 kHz 2nd IF signal.

The 2nd IF signal is applied to the each demodulator circuits by AM or FM mode.

• FM MODE

The 2nd IF signal is output from the FM IF IC (IC1004, pin 3) and passes through the ceramic bandpass filter (F11002). The filtered signal is fed back to the IC, and amplified at the limiter amplifier section (pin 5), then demodulated into AF signals at the quadrature detector section (pins 10, 11). The detected AF signals are output from pin 9 and are applied to the AF circuit via the AM/FM selector circuit (IC2016, pins 7, 1).

• AM MODE

The 2nd IF signal is output from the FM IF IC (IC1001, pin 3) and passes through the ceramic bandpass filter (F11002). The filtered signal is applied to the AM detector circuit (Q1025) to convert into AF signals, and then amplified at the Q1022 (pins 5, 1). The amplified AF signals are applied to the AF circuit via the AM/FM selector circuit (IC2016, pins 6, 1).

4-1-10 AF AMPLIFIER CIRCUIT FOR RIGHT SIDE DISPLAY (MAIN UNIT)

The AF amplifier circuit amplifies the demodulated AF signals to drive a speaker.

The AF signals pass through the AF mute switch (Q1011), and are then applied to the electric volume control circuit (IC2011, pin 8) as "UAFO" signal after being passed through the low-pass filter (Q1008). The level controlled AF signals are output from pin 7, and are then applied to the AF power amplifier (IC2012, pin 5) via the "VOUT2" signal. The power amplified AF signals are applied to the internal speaker (SP1) via the [EXT SP] jack (J2004).

When no plug is connected to the jack, the signals are fed back to the UHF audio input (IC2012, pin 2) and combined with the UHF audio. The mixed audio is applied to the other external speaker jack (J2005) and then to the internal speaker.

The electronic volume control circuit controls AF gain, therefore, the AF output level is according to the [VOL] setting and also the squelch conditions.

4-1-11 NOISE SQUELCH CIRCUIT FOR RIGHT SIDE DISPLAY (MAIN UNIT)

• NOISE SQUELCH

A noise squelch circuit cuts out AF signals when no RF signal is received. By detecting noise components in the AF signal, the squelch circuit switches the AF mute switch.

A portion of the AF signals from the FM IF IC (IC1004, pin 9) are applied to the active filter section (IC1004, pin 8). The active filter section amplifies and filters noise components. The filtered signals are applied to the noise detector section and output from the IC1004 (pin 14) as the "R_SQL" signal. The "R_SQL" signal from IC1004 (pin 14) is applied to the CPU (IC2013, pin 38). The CPU analyzes the noise condition and outputs the "R_DET_MUTE" signal (pin 58) to the AF mute switch (Q1011).

• 2ND IF AND DEMODULATOR CIRCUIT FOR RIGHT SIDE DISPLAY

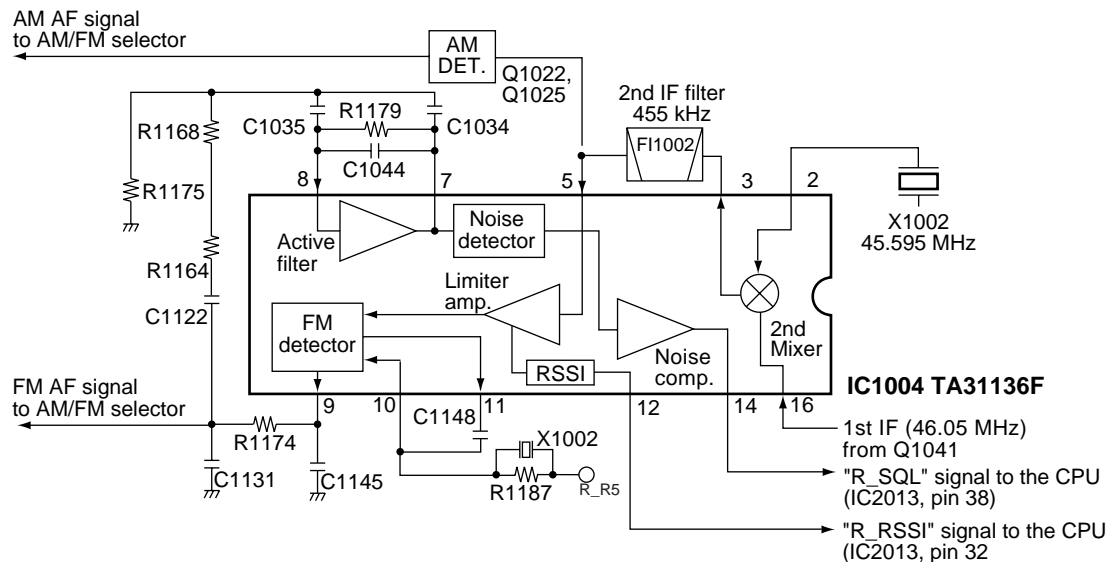

• TONE SQUELCH

The tone squelch circuit detects AF signals and opens the squelch only when receiving a signal containing a matching subaudible tone (CTCSS). When tone squelch is in use, and a signal with a mismatched or no subaudible tone is received, the tone squelch circuit mutes the AF signals even when noise squelch is open.

A portion of the AF signals from the FM IF IC (IC1004, pin 9) passes through the low-pass filter (Q1004) to remove AF (voice) signals. The filtered signal is applied to the CTCSS decoder which is inside the CPU (IC2013, pin 39) via the "R_DTCS_IN" line to control the AF mute switch (Q1011).

4-2 TRANSMITTER CIRCUITS

4-2-1 MICROPHONE AMPLIFIER CIRCUIT (MAIN AND CONTROL UNITS)

The microphone amplifier circuit amplifies audio signals from the microphone to a level needed for the modulation circuit. The microphone amplifier circuit is commonly used for the both VHF and UHF bands.

• THE AF SIGNALS FROM THE MAIN UNIT

The AF signals from the microphone (J2001, pin 6) pass through the high-pass filter (Q2028), and are then applied to the microphone amplifier (IC2014, pin 3). The amplified signals are applied to the analog switch (IC2008, pin 1).

The microphone sensitivity is controlled by the microphone sensitivity controller (Q2023) via the "MIC_SENS" line from the CPU (IC2023).

• THE AF SIGNALS FROM THE CONTROL UNIT

The AF signals from the microphone (CONTROL unit; J1, pin 6) are applied to the microphone amplifier (Q15, IC5 pin 3). The amplified signals pass through the J2, pin 2 via the "MIC" line, and are then applied to the analog switch (IC2008, pin 4).

The microphone sensitivity is controlled by the microphone sensitivity controller (Q2022) via the "MIC_SENS" line from the CPU (IC2023).

The each AF signals (from IC2008, pins 1, 4) are applied to the IDC limiter amplifier section (IC1000a, pin 3), and then pass through the de-emphasis circuit (C1036, R1050). The signals pass through the splatter filter (IC1000d, pins 13, 14), and are then applied to the buffer amplifier (IC1000c, pin 9). The amplified signals are applied to the D/A convertor IC (IC1009, pin 12) to control the modulation level.

• THE DATA SIGNALS

(1) 9600 bps mode

The data signals from the J2003, pin 1 are applied to the analog switch (IC2007, pin 4) after being passed through the limiter circuit (D2012). The signals pass through another analog switch (IC2008, pins 9 and 8), and are then applied to the buffer amplifier (IC100c, pin 9) via the "DATAMOD" line. The amplified signals are applied to the D/A convertor IC (IC1009, pin 12) to control the modulation level.

(2) 1200 bps mode

The data signals from the J2003, pin 1 are applied to the analog switch (IC2007, pin 4) after being passed through the limiter circuit (D2012). The signals pass through another analog switch (IC2008, pins 10 and 11), and are then applied to the IDC limiter amplifier section (IC1000a, pin 3). The signals pass through the de-emphasis circuit (C1036, R1050) and splatter filter (IC1000d, pins 13, 14). The signals are amplified at the buffer amplifier (IC1000c, pin 9), and are then applied to the D/A convertor IC (IC1009, pin 12) to control the modulation level.

The AF or data signals are applied to the each VCO circuit from the D/A convertor IC (IC1009, pin 11) as "MOD" signal.

4-2-2 VHF MODULATION CIRCUIT (MAIN AND VCO UNITS)

The modulation circuit modulates the oscillating signal (RF signal) using the microphone audio signals.

The "MOD" signal from the D/A convertor IC (IC1009, pin 11) changes the reactance of D5 (VCO unit) to modulate the oscillated signal at the VHF-VCO circuit (VCO unit; Q6). The modulated signal is amplified at the buffer amplifiers (VCO unit; Q7, Q8), and then passes through the VCO switch (VCO unit; D12, D13). The TX LO signal passes through the low-pass filter (L90, L91, C245–C247) and attenuator (C2134, R2216–C2218), and is then applied to the TX switch (D77) via the "VHF_YGR" line. The signal is applied to the drive/power amplifier circuits.

4-2-3 UHF MODULATION CIRCUIT (MAIN UNIT)

The "MOD" signal from the D/A convertor IC (IC1009, pin 11) changes the reactance of D1018 to modulate the oscillated signal at the UHF-VCO circuit (Q1039). The modulated signal is amplified at the buffer amplifiers (Q1044, Q1047), and then passes through the VCO switch (D2059, D2060). The TX LO signal passes through the high-pass filter (L1079, C2183, C2184), and is then applied to the TX switch (D78) via the "UHF_YGR" line. The signal is applied to the drive/power amplifier circuits.

4-2-4 DRIVE/POWER AMPLIFIER CIRCUITS (MAIN UNIT)

The drive amplifier circuit amplifies the VCO oscillated signal to the needed level at the power amplifier. Q27 is a power module which provides stable 50 W (UHF is 35 W) output power with a 13.8 V DC power source.

The RF signal from the TX switch (D77; VHF, D78; UHF) is amplified at the buffer amplifier (Q38), and is then applied to the pre-amplifier (Q16). The amplified signal is amplified at the pre-drive (Q21) and drive amplifier (Q25), and then applied to the power amplifier (Q27) to obtain 50 W (UHF is 35 W) of RF power.

• VHF RF SIGNAL

The amplified signal passes through the low-pass filter (D36, D2070), and is then applied to the SWR detector (D57, D61). The signal is applied to the TX/RX switch (D42), and passes through the low-pass filter (L76, L77, L80, C205, C209, C242, C243, C264) to suppress high harmonics components. The signal is applied to the antenna connector after being passed through the reverse power detector circuit (D70, D71).

• UHF RF SIGNAL

The amplified signal passes through the TX/RX switch (D37, D38, D41, D43–D45, D68), and is then applied to the SWR detector (D50, D58). The signal passes through the high-pass filter (L78, L81, C206, C210, C213, C265) to suppress high harmonics components. The signal is applied to the antenna connector after being passed through the reverse power detector circuit (D70, D71).

The detected voltage at the reverse detector circuit is applied to the CPU (IC2013, pin 35) to switch from high power to middle power automatically when the SWR become worse.

4-2-5 APC CIRCUIT (MAIN UNIT)

The APC circuit protects the pre-drive (Q21), drive amplifier (Q25) and power amplifier (Q27) from a mismatched output load and stabilizes the output power.

• VHF APC CIRCUIT

The SWR detector circuit (D57, D61) detects forward signals and reflection signals at D57 and D61 respectively. The impedance is matched at 50 Ω and is increased when it is mismatched.

• UHF APC CIRCUIT

The SWR detector circuit (D50, D58) detects forward signals and reflection signals at D50 and D58 respectively. The impedance is matched at 50 Ω and is increased when it is mismatched.

The detected voltage is applied to the differential amplifier (IC2, pin 3) via the "POWER_DET" line, and the power setting voltage from the D/A converter (IC1, pin 12) is applied to another input (IC2, pin 1) for the reference as "PWRCON" line.

• APC CIRCUIT

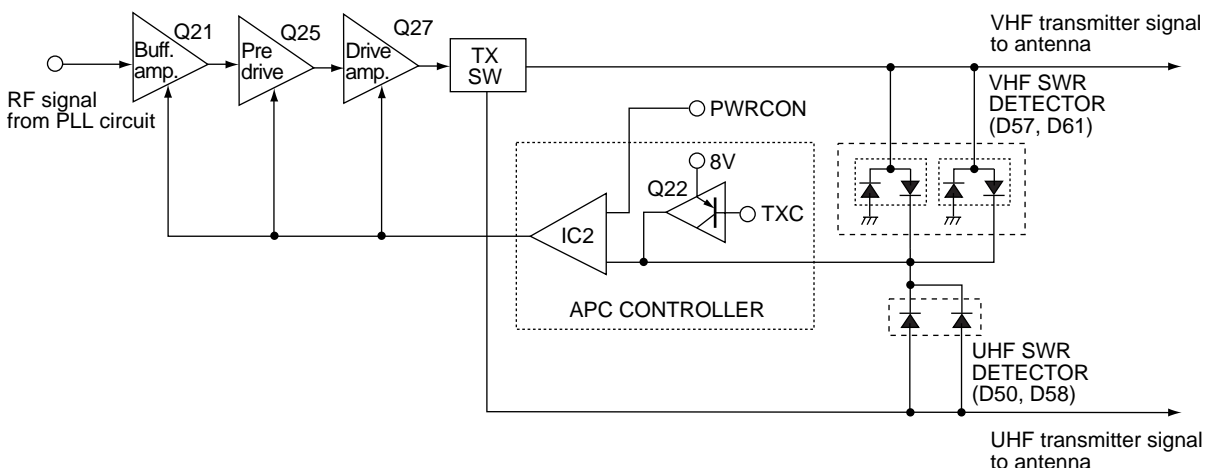

When antenna impedance is mismatched, the detected voltage exceeds the power setting voltage. The output voltage of the differential amplifier (IC2, pin 4) controls the input current of the pre-drive (Q21), drive amplifier (Q25) and power amplifier (Q27) to reduce the output power.

4-3 PLL CIRCUITS

4-3-1 GENERAL

A PLL circuit provides stable oscillation of the transmit frequency and the receive local frequency. The PLL circuit compares the phase of the divided VCO frequency to the reference frequency. The PLL output frequency is controlled by a crystal oscillator and the divided ratio (N-data) of the programmable divider.

4-3-2 PLL CIRCUIT FOR RIGHT SIDE DISPLAY (MAIN UNIT)

The R-VCO (for right side display) composes of VHF-VCO and UHF-VCO circuits.

• FROM THE VHF-VCO CIRCUIT

An oscillated signal from the VHF-VCO circuit (Q1038, D1014, D1015) passes through the buffer amplifiers (Q1043, Q1016) and VCO switch (D1023) is applied to the PLL IC for right side display (IC1008, pin 8)

• FROM THE UHF-VCO CIRCUIT

An oscillated signal from the UHF-VCO circuit (Q1038, D1016–D1018) passes through the buffer amplifiers (Q1044, Q1016) and VCO switch (D1023) is applied to the right side displayed PLL IC (IC1008, pin 8)

And is then prescaled in the PLL IC based on the divided ratio (N-data). The reference signal is generated at the reference oscillator (VCO unit; X1, 12.8 MHz), and is then amplified at the buffer amplifier (Q1012). The reference signal is also applied to the PLL IC. The PLL IC detects the out-of-step phase using the reference frequency and outputs it from pin 16. The output signal is passed through the loop filter (Q1020, Q1021, D1008) and is then applied to the right side display VCO circuit as lock voltage.

4-3-3 R-VCO CIRCUIT FOR RIGHT SIDE DISPLAY (MAIN UNIT)

The VCO circuit for right side display contains a separated the VHF-VCO (Q1038, D1014, D1015) and UHF-VCO (Q1039, D1016–D1018) circuits.

• VHF-VCO (RX ONLY)

The oscillated signal at the VHF-VCO circuit is amplified at the buffer amplifier (Q1043), and then passes through the attenuator (R2209–R2211, C2123) and low-pass filter (L1045, L1046, C1207, C1249, C1250, C1289, C1304). The signal is applied to the 1st mixer circuit for right side display (IC1006, pin 4) via the VCO switch (D1028) as the 1st LO signal.

A portion of the signal from the buffer amplifier (Q1043) passes through the VCO switch (D1023), and is then amplified at the buffer amplifier (Q1016). The amplified signal is fed back to the PLL IC (IC1008, pin 8) as the comparison signal.

• UHF-VCO

The oscillated signal at the UHF-VCO circuit is amplified at the buffer amplifiers (Q1044, Q1047), and is then applied to the VCO switch (D2059, D2060) to divide UHF TX signal and RX signal.

(1) UHF TX SIGNAL

The TX UHF signal passes through the high-pass filter (L1079, C2183, C2184) to suppress harmonics components, and is then applied to the TX switch (D78). The signal is applied to the drive/power amplifier circuit.

(2) RX SIGNAL

The 400 MHz band RX signal is applied to the another VCO switches (D1038 and D1049), and then passes through the attenuator (R2206–R2208, C2122) and low-pass filter (L1034, L1035, C1258). The filtered signal passes through the VCO switch (Q1048, D1039), and is then applied to the 1st mixer circuit (IC1006, pin 4) as the 1st LO signal.

The 900 MHz band RX signal passes through the another VCO switches (D1027 and D1028), and is then amplified at the buffer amplifier (Q1042). The signal passes through the attenuator (L1020, C1202, C1206) and low-pass filter (L1021, L1036, C1252, C1259, C1260). The filtered signal passes through the VCO switch (D1026), and is then applied to the 1st mixer circuit (IC1006, pin 4) as the 1st LO signal.

A portion of the signal from the buffer amplifier (Q1044) passes through the VCO switch (D1024), and is then amplified at the buffer amplifier (Q1016). The amplified signal is fed back to the PLL IC (IC1008, pin 8) as the comparison signal.

4-3-4 PLL CIRCUIT FOR LEFT SIDE DISPLAY (VCO UNIT)

An oscillated signal from the L-VCO circuit passes through the buffer amplifiers (Q7, Q1) is applied to the PLL IC for left side display (IC1, pin 8).

• PLL CIRCUIT FOR RIGHT SIDE DISPLAY

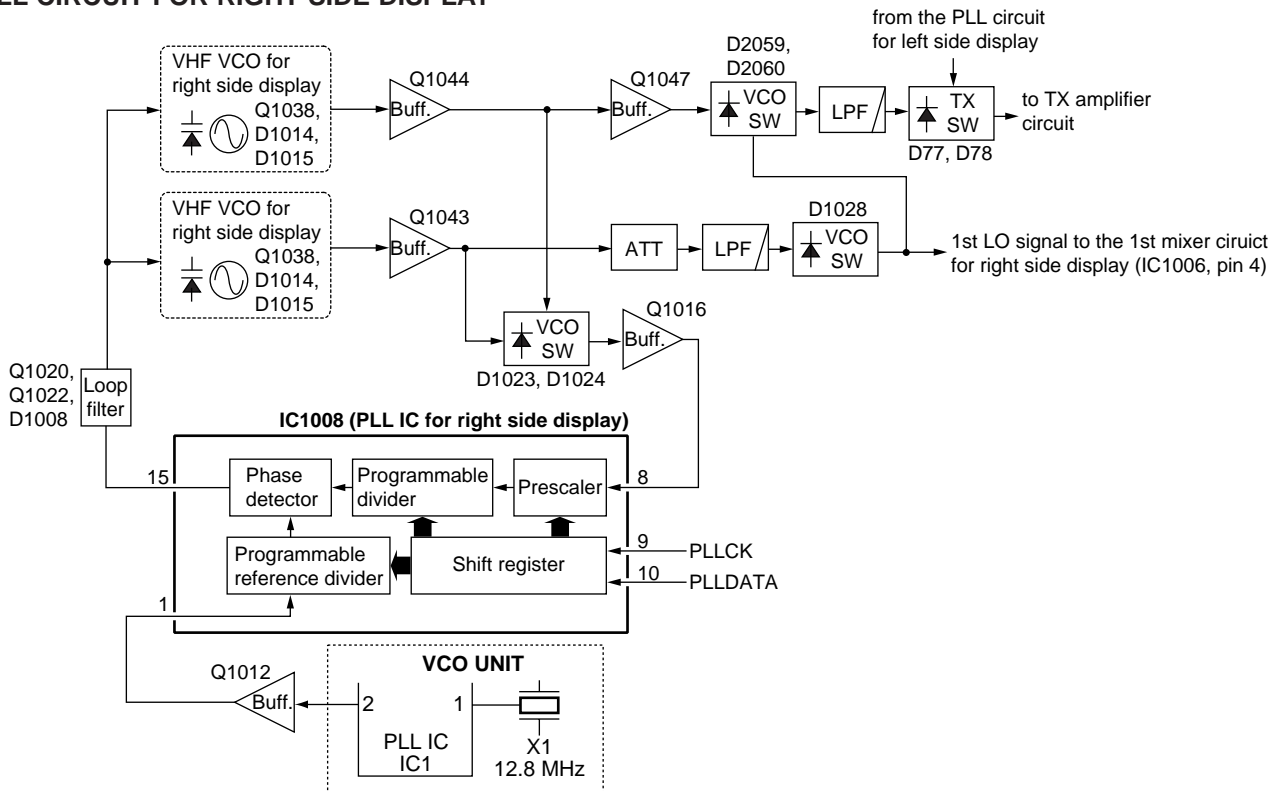

And is then prescaled in the PLL IC based on the divided ratio (N-data). The reference signal is generated at the reference oscillator (X1, 12.8 MHz). The reference signal is also applied to the PLL IC. The PLL IC detects the out-of-step phase using the reference frequency and outputs it from pin 16. The output signal is passed through the loop filter (Q2, Q3, D2) and is then applied to the left side display VCO circuit as lock voltage.

4-3-5 L-VCO CIRCUIT FOR LEFT SIDE DISPLAY (VCO AND MAIN UNITS)

• VHF TX SIGNAL

The oscillated signal at the VCO circuit is amplified at the buffer amplifiers (Q7 and Q8), and then passes through the low-pass filter (MAIN unit; L90, L91, C245–C247) and attenuator (R2216–R2218, C2134) via the VCO switch (D12, D13). The signal is applied to the drive/power amplifier circuit (MAIN unit) after being passed through the TX switch (MAIN unit; D77).

• RX SIGNAL

The oscillated signal at the VCO circuit is amplified at the buffer amplifiers (Q7, Q8), and is then applied to the VCO switch (D7–D9, D15). The signal is applied to the normal oscillating signal, twice oscillating signal or half oscillating signal circuit.

(1) NORMAL OSCILLATING SIGNAL CIRCUIT

The signal from the VCO switch (D7) passes through the attenuator (R33, R37, R38, C41) and low-pass filter (L5, L9, C45, C47, C53, C63, C64), and then applied to the VCO switch (D10) which is controlled by the “L_VR5” signal.

(2) TWICE OSCILLATING SIGNAL CIRCUIT

The signal from the VCO switch (D9) passes through the high-pass (L6, C46, C48, C49), low-pass (L8, C52, C54, C57) and high-pass (L11, C58, C65) filters to obtain twice oscillating signal. The signals is applied to the VCO switch (D11) which is controlled by the “L_UR5” signal.

(3) HRF OSCILLATING SIGNAL CIRCUIT

The signal from the VCO switch (D15) is applied to the pre-scaler circuit (IC3, pin 2) to divide half oscillating signal. The divided signal is applied to the VCO switch (D16). The regulator circuit provides the pre-scaler’s power supply. The circuit is controlled by the “L_LO_SW” signal.

The signal from the each VCO switch is applied to the 1st mixer circuit for right side display (MAIN unit; IC1005, pin 4) as the 1st LO signal.

A portion of the signal from the buffer amplifier (Q7) is amplified at the buffer amplifier (Q1), and is then fed back to the PLL IC (IC1, pin 8) as the comparison signal.

4-4 POWER SUPPLY CIRCUITS

4-4-1 CONTROL UNIT VOLTAGE LINE

Line	Description
HV	The 13.8V external DC power from the power connector (MAIN unit; J2000). The voltage is supplied to the LCD back light circuit (DS1–DS12), etc.
8V	Common 8 V converted from the HV line at the +8 regulator circuit (Q1, Q3, D1). The output voltage is applied to the microphone amplifier regulator circuit (Q16), key back light circuit (DS13–DS18).
CPU5	Common 5 V converted from the HV line by the +5 regulator circuit (CONTROL unit; IC3). The output voltage is applied to the buffer amplifier (CONTROL unit; Q2) and reset circuit (CONTROL unit; IC2), control unit CPU (IC4) and PTT detector (Q5, D3, D4).

• PLL CIRCUIT FOR LEFT SIDE DISPLAY

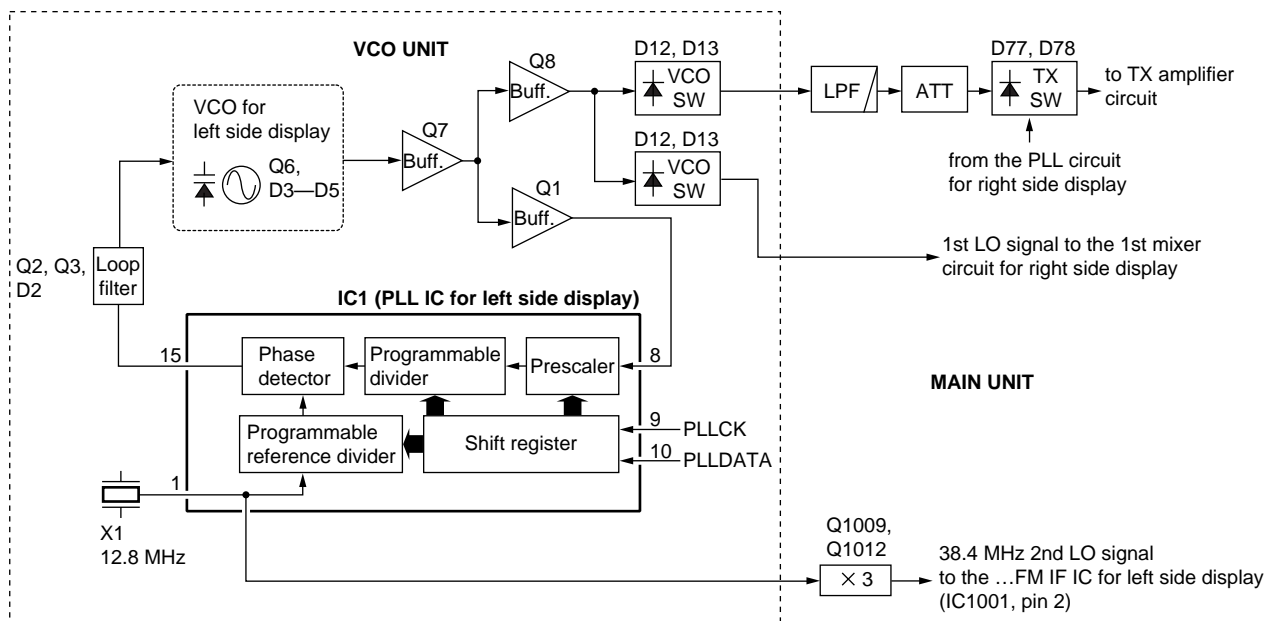

4-4-2 MAIN UNIT VOLTAGE LINE

Line	Description
HV	The 13.8V external DC power from the power connector.
VCC	The same voltage as the HV line which is controlled by the VCC regulator circuit (MAIN unit; Q2001). When the [POWER] switch is pushed, the CPU outputs control signal to the power switch controller (Q2003) to turn the circuit ON.
5V	Common 5 V for the CPU converted from the HV line by the 5V regulator circuit (IC2002). The voltage line is also applied to the CPU when IC-2720H is power OFF.
8V	Common 8 V converted from the VCC line at the +8 regulator circuit (IC2003).
5VS	Common 5 V produced from the 5 V line by the +5 regulator circuit (Q2002, D2048). The output signal is applied to the PTT detector (Q2005), mic amplifier (IC2014, Q2028), etc.VHF transmit.
VT8	8 V produced from the 8V line at the VT8 regulator circuit (Q9, Q11).
UT8	UHF transmit 8V produced from the 8V line at the UT8 regulator circuit (Q10, Q12).
VUT8	VHF and UHF transmit 8 V produced from the 8 V line at the VUT8 regulator circuit (Q13, D1). The output voltage is applied to the buffer amplifier (Q38), pre-amplifier (Q16) and pre-driver (Q21).
L_AM5	Receive 5 V produced from the 5VS line at the L_R5 regulator circuit (Q1000). The output voltage is applied to the AM detector for left side display (Q1014, Q1017).
R_AM5	Receive 5 V produced from the 5VS line at the R_R5 regulator circuit (Q1002). The output voltage is applied to the AM detector for right side display (Q1022, Q1025).
L_R5	Receive 5 V produced from the 5VS line at the L_AM5 regulator circuit (Q1006). The output voltage is applied to the IF amplifier (Q1040) and FM IF IC (IC1001) for left side display.
R_R5	Receive 5 V produced from the 5VS line at the R_AM5 regulator circuit (Q1005). The output voltage is applied to the IF amplifier (Q1041) and FM IF IC (IC1004) for right side display.
L140_R5	Receive 5 V produced from the 5VS line at the L_R5 regulator circuit (Q1). The output voltage is applied to the RF amplifier (Q29) for left side display's 144 MHz bandpass filter.
R140_R5	Receive 5 V produced from the 5VS line at the R_R5 regulator circuit (Q2). The output voltage is applied to the RF amplifier (Q30) for right side display's 144 MHz bandpass filter.

MAIN UNIT VOLTAGE LINE—Continued

Line	Description
L220_R5	Receive 5 V produced from the 5VS line at the R_AM5 regulator circuit (Q3). The output voltage is applied to the RF amplifier (Q31) for left side display's 220 MHz bandpass filter.
L300_R5	Receive 5 V produced from the 5VS line at the L_AM5 regulator circuit (Q4). The output voltage is applied to the RF amplifier (Q32) for right side display's 300 MHz bandpass filter.
R400_R5	Receive 5 V produced from the 5VS line at the R_R5 regulator circuit (Q5). The output voltage is applied to the RF amplifier (Q19) for right side display's 430 MHz bandpass filter.
L400_R5	Receive 5 V produced from the 5VS line at the R_AM5 regulator circuit (Q6). The output voltage is applied to the RF amplifier (Q20) for left side display's 430 MHz bandpass filter.
R800_R5	Receive 5 V produced from the 5VS line at the L_AM5 regulator circuit (Q8). The output voltage is applied to the RF amplifier (Q18, Q35) for right side display's 910 MHz bandpass filter.
L_VCO8	Common 8 V produced from the 8 V line by the +8 regulator circuit (Q1023). The output voltage is applied to the VCO circuit (RF unit; Q6, D3–D5) and buffer amplifier (RF unit; Q8).
CPU5	Common 5 V converted from the HV line by the +5 regulator circuit (CONTROL unit; IC3). The output voltage is applied to the buffer amplifier (CONTROL unit; Q2) and reset circuit (CONTROL unit; IC2).

4-4-3 VCO UNIT VOLTAGE LINE

Line	Description
8V	Common 8 V converted from the VCC line at the +8 regulator circuit (MAIN unit; IC2003). The output voltage is applied to the filter switch (IC2), loop filter (Q2, Q3, D2) and buffer amplifier (Q8).
5VS	Common 5 V produced from the 5 V line by the +5 regulator circuit (MAIN unit; Q2002, D2048). The output voltage is applied to the PTT IC (IC1) and regulator circuit (Q9).
L_VCO8	Common 8 V produced from the 8 V line by the +8 regulator circuit (Q1023). The output voltage is applied to the VCO circuit (RF unit; Q6, D3–D5) and buffer amplifier (RF unit; Q8).

4-5 PORT ALLOCATIONS

4-5-1 CPU (MAIN UNIT; IC2013)

Pin number	Port name	Description
10	UMMUTE	Outputs microphone mute signal for right side display. Low: While microphone is muting.
11	CK_SHIFT1	Output clock shift signal.
16	TX_MUTE	Outputs transmit mute control signal. High: While transmit is muting.
17	MIC_PTT	Input port for microphone's PTT detecting signal.
18	SUB_SEL	Outputs sub band select signal.
20	UTX_CTRL	Outputs RF transmit power supply circuit control signal for left side display. High: While transmitting 400–479 MHz.
21	VTX_CTRL	Outputs RF transmit power supply circuit control signal for right side display. High: While transmitting 136–174 MHz.
22	DTCS_SEL	Outputs DTCS filter select signal.
24	ES_DATA	I/O port the data signal from/to the EEPROM (IC2000, pin 5).
25	ES_CK	Outputs clock signal to the EEPROM (IC2000, pin 6).
26	P_PTT	Input port for PTT detect signal in packet mode.
27	P_MOD_MUTE	Outputs modulation mute signal on packet mode Low: While packet mod. is muting.
28	98_DATA	Input port for data signal from HM-98.
29	MIC_U/D	Input port for up/down signal from the microphone.
30	CM_MUTE	Outputs the microphone mute signal to the CONTROL unit. Low: While the microphone is muting.
31	MIC_SEL	Input port for the connecting microphone detect signal for HM-98. Low: While HM-98 is connecting.
32	R_RSSI	Input port for the RSSI signal from the FM IF IC (IC1004, pin 12) to detect receiving signal strength for right side display.
33	L_RSSI	Input port for the RSSI signal from the FM IF IC (IC1001, pin 12) to detect receiving signal strength for left side display.
34	TEMP	Input port for chassis temperature detecting signal.
35	REV_DET	Input port for the reverse power detecting signal.
38	R_SQL	Input port for the squelch level for right side display.
39	R_DTCS_IN	Input port for the DTCS or CTCSS signal for right side display.
40	L_SQL	Input port for the squelch level for the left side display.
41	L_DTCS_IN	Input port for the DTCS or CTCSS signal for left side display.
44	DTMF	Outputs DTMF, E-tone, beep signals.
45	DTCS	Outputs DTCS and CTCSS signals
47	P_SQL	Outputs the packet squelch signal.

Pin number	Port name	Description
48	FAN_CTRL	Outputs cooling fan control signal.
49	CLONE_OUT	Outputs the cloing data signal.
50	CLONE_IN	Input port for the cloing data signal.
51	D/A_DATA	Outputs serial data to the D/A converter IC (IC1, pins 15–17).
52	D/A_CK	
53	D/A_STB	
54	MM_MUTE	Outputs microphone mute control signal for MAIN unit. Low: While the microphone is muting.
55	L_AF_MUTE	Outputs AF mute control signal for left side display. High: While AF audio is muting.
56	R_AF_MUTE	Outputs AF mute control signal for right side display. High: While AF audio is muting.
57	L_DET_MUTE	Outputs detector mute signal for left side display.
58	R_DET_MUTE	Outputs detector mute signal for right side display.
60	AF_VOL_CK	Outputs the volume serial signal.
61	AF_VOL_DATA	
62	L_R5CTRL	Outputs the RX RF power supply control signal for left side display.
63	R_UVCO_SEL	Outputs the VCO select signal for right side display. High: While receiving 320–999.9 MHz on right side display.
64	L_UNLOCK	Input port for the PLL unlock signal for left side display (VCO unit; IC1, pin 7). Low: The PLL Lock voltage is unlock for left side display.
65	1200/9600SEL	Outputs 1200 or 9600 bps packet baud rate select signal. Low: 9600 bps baud rate is selected.
66	L_RX400	Outputs the 400 MHz receiver circuit select signal for left side display. High: While receiving 310–550 MHz on left side display.
67	L_RX300	Outputs the 300 MHz receiver circuit select signal for left side display. High: While receiving 205–309.995 MHz on left side display.
68	L_AM	Outputs receive mode select signal for left side display. Low: AM mode is selected.
69	R_AM	Outputs receive mode select signal for right side display. Low: AM mode is selected.
72	R_RX220	Outputs the 220 MHz receiver circuit select signal for left side display. Low: While receiving 174–254.995 MHz on left side display.
73	L_RX140	Outputs the 144 MHz receiver circuit select signal for left side display. Low: While receiving 118–173.995 MHz on left side display.
74	R_RX800	Outputs the 800 MHz receiver circuit select signal for right side display. Low: While receiving 810–999.990 MHz on right side display.

CPU-Continued

Pin number	Port name	Description
75	L_400SHIFT	Outputs shift signal to the 430 MHz bandpass filter for left side display. High: While receiving 310–450 MHz on left side display.
76	R_RX400	Outputs the 430 MHz receiver circuit select signal for right side display. Low: While receiving 360–549.990 MHz on right side display.
77	R_RX140	Outputs the 144 MHz receiver circuit select signal for right side display. Low: While receiving 118–174 MHz on right side display.
78	LR_R5CTRL	Outputs the RX RF power supply control signal for right side display. High: While receiving on left side display.
79	L_VCO_SHIFT	Outputs the VCO select signal for left side display. High: While transmitting 400–479 MHz on left side display.
80	R400_SHIFT	Outputs 430 MHz bandpass filter shift signal for right side display. High: While receiving 360–450 MHz on right side display.
81	R_VVCO_SEL	Output VCO select signal for right side display. High: While receiving 118–174 MHz on right side display.
82	L_PLLSW	Outputs PLL loop select signal for right side display.
83	R_PLLSW	Outputs PLL loop select signal for left side display.
84	R_UNLOCK	Input port for the PLL unlock signal for right side display (IC1008, pin 7). Low: The PLL lock voltage is unlocked for right side display.
85	P_L/R_SEL	Outputs packet band select signal.
86–89	MATRIX_IN1– MATRIX_IN4	Input ports for Initial matrix.
90 91	PLLDATA PLLCK	Outputs serial signal to the PLL IC (IC1008, pins 9, 10 and VCO unit; IC1, pins 9, 10).
93 94 95 96	MATRIX_OUT1 MATRIX_OUT2 MATRIX_OUT3 MATRIX_OUT4	Outputs Initial matrix signal.

4-5-2 D/A CONVERTER IC (CONTROL UNIT; IC4)

Pin number	Port name	Description
2, 3	R_BPF3 R_BPF4	Output tracking signals to the bandpass filter for right side display.
4–7	L_BPF1, L_BPF2, L_BPF3, L_BPF4	Output tracking signals to the bandpass filter for left side display.
8	L-ATT	Outputs the attenuator circuit control signal for left side display.
9	R-ATT	Outputs the attenuator circuit control signal for right side display.
12	PWRCON	Outputs control signal for RF output power.
18, 19	R-BPF1, R-BPF2	Output tracking signals to the bandpass filter for right side display.

SECTION 5 PARTS LIST

[CONTROL UNIT]

REF NO.	ORDER NO.	DESCRIPTION	
IC1	1110002750	S.IC	TA75S01F (TE85R)
IC2	1110005780	S.IC	S-80945CLMC-G7F-T2
IC3	1180000420	S.IC	TA78L05F (TE12R)
IC4	1140010230	S.IC	HD6473847RH (FX-2493D)
IC5	1130007370	S.IC	TA75S558F (TE85L)
Q1	1530002690	S.TRANSISTOR	2SC4116-GR (TE85R)
Q2	1590001650	S.TRANSISTOR	XP4601 (TX)
Q3	1510000770	S.TRANSISTOR	2SA1586-GR (TE85R)
Q5	1530002690	S.TRANSISTOR	2SC4116-GR (TE85R)
Q6	1530002690	S.TRANSISTOR	2SC4116-GR (TE85R)
Q7	1530002690	S.TRANSISTOR	2SC4116-GR (TE85R)
Q8	1530002690	S.TRANSISTOR	2SC4116-GR (TE85R)
Q9	1530002690	S.TRANSISTOR	2SC4116-GR (TE85R)
Q10	1530002690	S.TRANSISTOR	2SC4116-GR (TE85R)
Q11	1530002690	S.TRANSISTOR	2SC4116-GR (TE85R)
Q12	1530002690	S.TRANSISTOR	2SC4116-GR (TE85R)
Q13	1530002690	S.TRANSISTOR	2SC4116-GR (TE85R)
Q15	1530002690	S.TRANSISTOR	2SC4116-GR (TE85R)
Q16	1530002690	S.TRANSISTOR	2SC4116-GR (TE85R)
D1	1730002280	S.ZENER	MA8091-M (TX)
D2	1730002340	S.ZENER	MA8047-M (TX)
D3	1750000550	S.DIODE	1SS355 TE-17
D4	1790001000	S.ZENER	MA8062-L (TX)
X1	6060000610	S.CERAMIC	EFOS4914E3
R1	7210002920	VARIABLE	EVU-F2AF20B55 (560K)
R2	7030003440	S.RESISTOR	ERJ3GEYJ 102 V (1 kΩ)
R3	7210002920	VARIABLE	EVU-F2AF20B55 (560K)
R4	7030003440	S.RESISTOR	ERJ3GEYJ 102 V (1 kΩ)
R5	7210002920	VARIABLE	EVU-F2AF20B55 (560K)
R6	7030003440	S.RESISTOR	ERJ3GEYJ 102 V (1 kΩ)
R7	7210002920	VARIABLE	EVU-F2AF20B55 (560K)
R8	7030003440	S.RESISTOR	ERJ3GEYJ 102 V (1 kΩ)
R9	7030003640	S.RESISTOR	ERJ3GEYJ 473 V (47 kΩ)
R10	7030003640	S.RESISTOR	ERJ3GEYJ 473 V (47 kΩ)
R11	7030003640	S.RESISTOR	ERJ3GEYJ 473 V (47 kΩ)
R12	7030003640	S.RESISTOR	ERJ3GEYJ 473 V (47 kΩ)
R13	7030003520	S.RESISTOR	ERJ3GEYJ 472 V (4.7 kΩ)
R14	7030003640	S.RESISTOR	ERJ3GEYJ 473 V (47 kΩ)
R15	7030005521	S.RESISTOR	ERA3YKD 334V (330 kΩ)
R16	7030005501	S.RESISTOR	ERA3YKD 124V (120 kΩ)
R17	7030005691	S.RESISTOR	ERA3YED 123V
R18	7030003560	S.RESISTOR	ERJ3GEYJ 103 V (10 kΩ)
R19	7030000020	S.RESISTOR	MCR10EZHZ 1 Ω (010)
R20	7030003520	S.RESISTOR	ERJ3GEYJ 472 V (4.7 kΩ)
R21	7030003520	S.RESISTOR	ERJ3GEYJ 472 V (4.7 kΩ)
R22	7030003760	S.RESISTOR	ERJ3GEYJ 474 V (470 kΩ)
R23	7030003560	S.RESISTOR	ERJ3GEYJ 103 V (10 kΩ)
R24	7030003520	S.RESISTOR	ERJ3GEYJ 472 V (4.7 kΩ)
R25	7030003560	S.RESISTOR	ERJ3GEYJ 103 V (10 kΩ)
R26	7030003520	S.RESISTOR	ERJ3GEYJ 472 V (4.7 kΩ)
R27	7030003760	S.RESISTOR	ERJ3GEYJ 474 V (470 kΩ)
R28	7030003520	S.RESISTOR	ERJ3GEYJ 472 V (4.7 kΩ)
R29	7030003560	S.RESISTOR	ERJ3GEYJ 103 V (10 kΩ)
R30	7030003440	S.RESISTOR	ERJ3GEYJ 102 V (1 kΩ)
R31	7030003480	S.RESISTOR	ERJ3GEYJ 222 V (2.2 kΩ)
R32	7030003600	S.RESISTOR	ERJ3GEYJ 223 V (22 kΩ)
R35	7030003560	S.RESISTOR	ERJ3GEYJ 103 V (10 kΩ)
R39	7030003680	S.RESISTOR	ERJ3GEYJ 104 V (100 kΩ)
R41	7030003800	S.RESISTOR	ERJ3GEYJ 105 V (1 MΩ)
R42	7030003440	S.RESISTOR	ERJ3GEYJ 102 V (1 kΩ)
R43	7030003440	S.RESISTOR	ERJ3GEYJ 102 V (1 kΩ)
R44	7030003440	S.RESISTOR	ERJ3GEYJ 102 V (1 kΩ)
R45	7030003390	S.RESISTOR	ERJ3GEYJ 391 V (390 Ω)
R46	7030003440	S.RESISTOR	ERJ3GEYJ 102 V (1 kΩ)
R47	7030003440	S.RESISTOR	ERJ3GEYJ 102 V (1 kΩ)
R48	7030003440	S.RESISTOR	ERJ3GEYJ 102 V (1 kΩ)
R49	7030003390	S.RESISTOR	ERJ3GEYJ 391 V (390 Ω)
R50	7030003440	S.RESISTOR	ERJ3GEYJ 102 V (1 kΩ)

[CONTROL UNIT]

REF NO.	ORDER NO.	DESCRIPTION	
R51	7030003440	S.RESISTOR	ERJ3GEYJ 102 V (1 kΩ)
R52	7030003440	S.RESISTOR	ERJ3GEYJ 102 V (1 kΩ)
R53	7030003390	S.RESISTOR	ERJ3GEYJ 391 V (390 Ω)
R54	7030003440	S.RESISTOR	ERJ3GEYJ 102 V (1 kΩ)
R55	7030003440	S.RESISTOR	ERJ3GEYJ 102 V (1 kΩ)
R56	7030003440	S.RESISTOR	ERJ3GEYJ 102 V (1 kΩ)
R57	7030003390	S.RESISTOR	ERJ3GEYJ 391 V (390 Ω)
R58	7030003680	S.RESISTOR	ERJ3GEYJ 104 V (100 kΩ)
R59	7030003680	S.RESISTOR	ERJ3GEYJ 104 V (100 kΩ)
R60	7030003680	S.RESISTOR	ERJ3GEYJ 104 V (100 kΩ)
R61	7030003580	S.RESISTOR	ERJ3GEYJ 153 V (15 kΩ)
R62	7030003440	S.RESISTOR	ERJ3GEYJ 102 V (1 kΩ)
R63	7030003520	S.RESISTOR	ERJ3GEYJ 472 V (4.7 kΩ)
R64	7030003520	S.RESISTOR	ERJ3GEYJ 472 V (4.7 kΩ)
R65	7030003390	S.RESISTOR	ERJ3GEYJ 391 V (390 Ω)
R66	7030003390	S.RESISTOR	ERJ3GEYJ 391 V (390 Ω)
R67	7030003380	S.RESISTOR	ERJ3GEYJ 331 V (330 Ω)
R71	7030003440	S.RESISTOR	ERJ3GEYJ 102 V (1 kΩ)
R72	7030003560	S.RESISTOR	ERJ3GEYJ 103 V (10 kΩ)
R73	7030003560	S.RESISTOR	ERJ3GEYJ 103 V (10 kΩ)
R74	7030003560	S.RESISTOR	ERJ3GEYJ 103 V (10 kΩ)
R75	7030003560	S.RESISTOR	ERJ3GEYJ 103 V (10 kΩ)
R76	7030003620	S.RESISTOR	ERJ3GEYJ 333 V (33 kΩ)
R77	7030003660	S.RESISTOR	ERJ3GEYJ 683 V (68 kΩ)
R78	7030003520	S.RESISTOR	ERJ3GEYJ 472 V (4.7 kΩ)
R79	7030003520	S.RESISTOR	ERJ3GEYJ 472 V (4.7 kΩ)
R80	7030003530	S.RESISTOR	ERJ3GEYJ 562 V (5.6 kΩ)
R81	7030003600	S.RESISTOR	ERJ3GEYJ 223 V (22 kΩ)
R82	7030003600	S.RESISTOR	ERJ3GEYJ 223 V (22 kΩ)
R83	7030003580	S.RESISTOR	ERJ3GEYJ 153 V (15 kΩ)
R85	7030003760	S.RESISTOR	ERJ3GEYJ 474 V (470 kΩ)
R88	7030003500	S.RESISTOR	ERJ3GEYJ 332 V (3.3 kΩ)
C1	4030006880	S.CERAMIC	C1608 JB 1H 472K-T
C2	4030006880	S.CERAMIC	C1608 JB 1H 472K-T
C3	4030006880	S.CERAMIC	C1608 JB 1H 472K-T
C4	4030006880	S.CERAMIC	C1608 JB 1H 472K-T
C5	4030007130	S.CERAMIC	C1608 CH 1H 101J-T
C6	4030007090	S.CERAMIC	C1608 CH 1H 470J-T
C7	4030007130	S.CERAMIC	C1608 CH 1H 101J-T
C8	4030007130	S.CERAMIC	C1608 CH 1H 101J-T
C10	4030007130	S.CERAMIC	C1608 CH 1H 101J-T
C12	4030011600	S.CERAMIC	C1608 JB 1E 104K-T
C13	4030006860	S.CERAMIC	C1608 JB 1H 102K-T
C14	4030006860	S.CERAMIC	C1608 JB 1H 102K-T
C15	4030006860	S.CERAMIC	C1608 JB 1H 102K-T
C16	4030006860	S.CERAMIC	C1608 JB 1H 102K-T
C18	4030006860	S.CERAMIC	C1608 JB 1H 102K-T
C19	4030006860	S.CERAMIC	C1608 JB 1H 102K-T
C20	4510004640	S.ELECTROLYTIC	ECEV1CA470SP
C22	4030006860	S.CERAMIC	C1608 JB 1H 102K-T
C23	4030012600	S.CERAMIC	C2012 JB 1A 105M-T
C24	4510004630	S.ELECTROLYTIC	ECEV1CA100SR
C25	4030006860	S.CERAMIC	C1608 JB 1H 102K-T
C26	4030006900	S.CERAMIC	C1608 JB 1H 103K-T
C27	4030006860	S.CERAMIC	C1608 JB 1H 102K-T
C28	4510004630	S.ELECTROLYTIC	ECEV1CA100SR
C29	4030006860	S.CERAMIC	C1608 JB 1H 102K-T
C30	4030007090	S.CERAMIC	C1608 CH 1H 470J-T
C31	4030007090	S.CERAMIC	C1608 CH 1H 470J-T
C32	4030006860	S.CERAMIC	C1608 JB 1H 102K-T
C33	4030006860	S.CERAMIC	C1608 JB 1H 102K-T
C34	4030006900	S.CERAMIC	C1608 JB 1H 103K-T
C35	4030011600	S.CERAMIC	C1608 JB 1E 104K-T
C36	4030011600	S.CERAMIC	C1608 JB 1E 104K-T
C37	4030011600	S.CERAMIC	C1608 JB 1E 104K-T
C39	4030011600	S.CERAMIC	C1608 JB 1E 104K-T
C40	4030011600	S.CERAMIC	C1608 JB 1E 104K-T
C41	4030011600	S.CERAMIC	C1608 JB 1E 104K-T
C42	4030006860	S.CERAMIC	C1608 JB 1H 102K-T
C43	4030006860	S.CERAMIC	C1608 JB 1H 102K-T
C44	4030006860	S.CERAMIC	C1608 JB 1H 102K-T
C45	4030006860	S.CERAMIC	C1608 JB 1H 102K-T
C46	4030008910	S.CERAMIC	C1608 JB 1H 393K-T
C47	4030008910	S.CERAMIC	C1608 JB 1H 393K-T

S.=Surface mount

[CONTROL UNIT]

REF NO.	ORDER NO.	DESCRIPTION	
C48	4550000530	S.TANTALUM	TESVA 1V 104M1-8L
C49	45500005980	S.TANTALUM	TEMSVA 1A 475M-8L
C50	4550003220	S.TANTALUM	TEMSVA 1E 105M-8L
C54	4550006250	S.TANTALUM	TEMSVA 1A 106M-8L
J1	6510023110	CONNECTOR	3008L-8P8C
J2	6510023170	CONNECTOR	3008L-6P6C
DS1	5040002370	S.LED	SML-010MT T86
DS2	5040002370	S.LED	SML-010MT T86
DS3	5040002370	S.LED	SML-010MT T86
DS4	5040002060	S.LED	SML-020MLT T86
DS5	5040002060	S.LED	SML-020MLT T86
DS6	5040002060	S.LED	SML-020MLT T86
DS7	5040002370	S.LED	SML-010MT T86
DS8	5040002370	S.LED	SML-010MT T86
DS9	5040002370	S.LED	SML-010MT T86
DS10	5040002060	S.LED	SML-020MLT T86
DS11	5040002060	S.LED	SML-020MLT T86
DS12	5040002060	S.LED	SML-020MLT T86
DS13	5010000120	S.LED	LN1371G-(TR)
DS14	5010000120	S.LED	LN1371G-(TR)
DS15	5010000120	S.LED	LN1371G-(TR)
DS16	5010000120	S.LED	LN1371G-(TR)
DS17	5010000120	S.LED	LN1371G-(TR)
DS18	5010000120	S.LED	LN1371G-(TR)
DS19	5030002210	LCD	L1-0500TAM
S1	2250000460	ENCODER	EVQ-VENF0224B
S2	2250000460	ENCODER	EVQ-VENF0224B
EP1	6910012350	S.BEAD	MMZ1608Y 102BT
EP2	6910012350	S.BEAD	MMZ1608Y 102BT
EP3	6910012350	S.BEAD	MMZ1608Y 102BT
EP4	6910012350	S.BEAD	MMZ1608Y 102BT
EP5	6910012350	S.BEAD	MMZ1608Y 102BT
EP6	6910012350	S.BEAD	MMZ1608Y 102BT
EP7	6910012350	S.BEAD	MMZ1608Y 102BT
EP8	6910012350	S.BEAD	MMZ1608Y 102BT
EP9	6910012350	S.BEAD	MMZ1608Y 102BT
EP10	6910012350	S.BEAD	MMZ1608Y 102BT
EP11	6910012350	S.BEAD	MMZ1608Y 102BT
EP12	6910012350	S.BEAD	MMZ1608Y 102BT
EP13	6910012350	S.BEAD	MMZ1608Y 102BT
EP14	6910012350	S.BEAD	MMZ1608Y 102BT
EP15	8930057510	LCD CONTACT	SRCN-2493-SP-N-W
EP16	0910054973	PCB	B 5765C
EP17	6910012350	S.BEAD	MMZ1608Y 102BT

[MAIN UNIT]

REF NO.	ORDER NO.	DESCRIPTION	
IC1	1110004310	S.IC	M62352GP 75EC
IC2	1110002750	S.IC	TA75S01F (TE85R)
IC1000	1110005340	S.IC	NJM12902V-TE1
IC1001	1110003200	S.IC	TA31136FN (EL)
IC1003	1130004200	S.IC	TC4S66F (TE85R)
IC1004	1110003200	S.IC	TA31136FN (EL)
IC1005	1110005620	S.IC	GN02039B-0L
IC1006	1110005620	S.IC	GN02039B-0L
IC1008	1140005990	S.IC	MB15A02PFV1-G-BND-ER
IC1009	1190000350	S.IC	M62363FP-650C
IC2000	1140008650	S.IC	HN58X2464TI
IC2001	1110005990	S.IC	S-80945CNMC-G9F-T2
IC2002	1180001070	S.IC	TA7805F (TE16L)
IC2003	1180001250	S.IC	TA7808F (TE16L)
IC2006	1110002750	S.IC	TA75S01F (TE85R)
IC2007	1130008090	S.IC	BU4066BCFV-E1
IC2008	1130008090	S.IC	BU4066BCFV-E1
IC2009	1130003760	S.IC	TC4S81F (TE85R)
IC2010	1130008090	S.IC	BU4066BCFV-E1
IC2011	1110004490	S.IC	M62429FP 700C
IC2012	1110002540	IC	LA4445
IC2013	1140010830	S.IC	HD64F2144AFA20 (FX-2493 EXP)
IC2014	1130007370	S.IC	TA75S558F (TE85L)
IC2015	1130006220	S.IC	TC4W53FU (TE12L)
IC2016	1130006220	S.IC	TC4W53FU (TE12L)
Q1	1590000860	S.TRANSISTOR	DTA114YUA T106
Q2	1590000860	S.TRANSISTOR	DTA114YUA T106
Q3	1590000860	S.TRANSISTOR	DTA114YUA T106
Q4	1590000860	S.TRANSISTOR	DTA114YUA T106
Q5	1590000860	S.TRANSISTOR	DTA114YUA T106
Q6	1590000860	S.TRANSISTOR	DTA114YUA T106
Q8	1590000860	S.TRANSISTOR	DTA114YUA T106
Q9	1590000430	S.TRANSISTOR	DTC144EUA T106
Q10	1590000430	S.TRANSISTOR	DTC144EUA T106
Q11	1510000670	S.TRANSISTOR	2SA1588-GR (TE85R)
Q12	1510000670	S.TRANSISTOR	2SA1588-GR (TE85R)
Q13	1520000460	S.TRANSISTOR	2SB1132 T100 R
Q14	1530002850	S.TRANSISTOR	2SC4116-BL (TE85R)
Q15	1530002850	S.TRANSISTOR	2SC4116-BL (TE85R)
Q16	1560001090	S.FET	2SK2854
Q18	1530003780	S.TRANSISTOR	2SC5624VH-TL
Q19	1580000740	S.FET	3SK320 (TE85L)
Q20	1580000740	S.FET	3SK320 (TE85L)
Q21	1560001160	S.FET	2SK3475 (TE12L)
Q22	1590000720	S.TRANSISTOR	DTA144EUA T106
Q23	1530002850	S.TRANSISTOR	2SC4116-BL (TE85R)
Q24	1580000710	S.FET	3SK274 (TE85L)
Q25	1560001060	S.FET	2SK3075 (TE12L)
Q26	1530002850	S.TRANSISTOR	2SC4116-BL (TE85R)
Q27	1560001190	FET	RD70HVF
Q28	1590000430	S.TRANSISTOR	DTC144EUA T106
Q29	1580000660	S.FET	3SK272-(TX)
Q30	1580000660	S.FET	3SK272-(TX)
Q31	1530003780	S.TRANSISTOR	2SC5624VH-TL
Q32	1530003780	S.TRANSISTOR	2SC5624VH-TL
Q33	1580000660	S.FET	3SK272-(TX)
Q34	1530002850	S.TRANSISTOR	2SC4116-BL (TE85R)
Q35	1530003260	S.TRANSISTOR	2SC5006-T1
Q38	1530002920	S.TRANSISTOR	2SC4226-T1 R25
Q1000	1590000860	S.TRANSISTOR	DTA114YUA T106
Q1001	1590000430	S.TRANSISTOR	DTC144EUA T106
Q1002	1590000860	S.TRANSISTOR	DTA114YUA T106
Q1003	1590001650	S.TRANSISTOR	XP4601 (TX)
Q1004	1590001650	S.TRANSISTOR	XP4601 (TX)
Q1005	1590000440	S.TRANSISTOR	DTA143ZUA T106
Q1006	1590000440	S.TRANSISTOR	DTA143ZUA T106
Q1007	1590001190	S.TRANSISTOR	XP6501-(TX) .AB
Q1008	1590001190	S.TRANSISTOR	XP6501-(TX) .AB
Q1009	1530002380	S.TRANSISTOR	2SC4215-Y (TE85R)
Q1010	1590001450	S.FET	2SJ144-GR (TE85R)
Q1011	1590001450	S.FET	2SJ144-GR (TE85R)
Q1012	1530002850	S.TRANSISTOR	2SC4116-BL (TE85R)
Q1013	1590000720	S.TRANSISTOR	DTA144EUA T106
Q1014	1590001190	S.TRANSISTOR	XP6501-(TX) .AB
Q1016	1530002560	S.TRANSISTOR	2SC4403-3-TL
Q1017	1590001190	S.TRANSISTOR	XP6501-(TX) .AB
Q1020	1510000770	S.TRANSISTOR	2SA1586-GR (TE85R)
Q1021	1530002690	S.TRANSISTOR	2SC4116-GR (TE85R)
Q1022	1590001190	S.TRANSISTOR	XP6501-(TX) .AB
Q1023	1530002850	S.TRANSISTOR	2SC4116-BL (TE85R)

S.=Surface mount

[MAIN UNIT]

REF NO.	ORDER NO.	DESCRIPTION
Q1025	1590001190	S.TRANSISTOR XP6501-(TX) .AB
Q1026	1590001650	S.TRANSISTOR XP4601 (TX)
Q1027	1590001650	S.TRANSISTOR XP4601 (TX)
Q1029	1590000430	S.TRANSISTOR DTC144EUA T106
Q1038	1530003580	S.TRANSISTOR 2SC5231C8-TL
Q1039	1530003580	S.TRANSISTOR 2SC5231C8-TL
Q1040	1530003220	S.TRANSISTOR 2SC4406-4-TL
Q1041	1530003220	S.TRANSISTOR 2SC4406-4-TL
Q1042	1530002920	S.TRANSISTOR 2SC4226-T1 R25
Q1043	1530003580	S.TRANSISTOR 2SC5231C8-TL
Q1044	1530003580	S.TRANSISTOR 2SC5231C8-TL
Q1047	1530003580	S.TRANSISTOR 2SC5231C8-TL
Q1048	1590000430	S.TRANSISTOR DTC144EUA T106
Q1049	1590000430	S.TRANSISTOR DTC144EUA T106
Q2000	1520000460	S.TRANSISTOR 2SB1132 T100 R
Q2002	1510000670	S.TRANSISTOR 2SA1588-GR (TE85R)
Q2003	1590000430	S.TRANSISTOR DTC144EUA T106
Q2005	1530002850	S.TRANSISTOR 2SC4116-BL (TE85R)
Q2006	1590000430	S.TRANSISTOR DTC144EUA T106
Q2007	1590000430	S.TRANSISTOR DTC144EUA T106
Q2008	1530003090	S.TRANSISTOR 2SC4213-B (TE85R)
Q2009	1590000430	S.TRANSISTOR DTC144EUA T106
Q2010	1530003090	S.TRANSISTOR 2SC4213-B (TE85R)
Q2011	1530003090	S.TRANSISTOR 2SC4213-B (TE85R)
Q2014	1590001650	S.TRANSISTOR XP4601 (TX)
Q2016	1590001780	S.TRANSISTOR XP4213 (TX)
Q2017	1590000660	S.TRANSISTOR DTC144TU T106
Q2018	1590000430	S.TRANSISTOR DTC144EUA T106
Q2019	1590000720	S.TRANSISTOR DTA144EUA T106
Q2022	1590000430	S.TRANSISTOR DTC144EUA T106
Q2023	1590000430	S.TRANSISTOR DTC144EUA T106
Q2024	1590001650	S.TRANSISTOR XP4601 (TX)
Q2025	1590001650	S.TRANSISTOR XP4601 (TX)
Q2028	1530002690	S.TRANSISTOR 2SC4116-GR (TE85R)
Q2029	1590000660	S.TRANSISTOR DTC144TU T106
Q2030	1590000720	S.TRANSISTOR DTA144EUA T106
D1	1160000140	S.DIODE DAP222 TL
D2	1790001240	S.DIODE MA2S728-(TX)
D3	1790001240	S.DIODE MA2S728-(TX)
D5	1790001240	S.DIODE MA2S728-(TX)
D8	1790001260	S.DIODE MA2S077-(TX)
D9	1790001260	S.DIODE MA2S077-(TX)
D11	1790001260	S.DIODE MA2S077-(TX)
D12	1750000720	S.VARICAP HVC375BTRF
D13	1750000720	S.VARICAP HVC375BTRF
D16	1750000720	S.VARICAP HVC375BTRF
D17	1750000720	S.VARICAP HVC375BTRF
D22	1750000720	S.VARICAP HVC375BTRF
D23	1750000720	S.VARICAP HVC375BTRF
D24	1720000240	S.DIODE 1SV172 (TE85R)
D25	1720000240	S.DIODE 1SV172 (TE85R)
D28	1790001260	S.DIODE MA2S077-(TX)
D29	1790001260	S.DIODE MA2S077-(TX)
D30	1790001260	S.DIODE MA2S077-(TX)
D31	1790001260	S.DIODE MA2S077-(TX)
D32	1750000710	S.VARICAP HVC350BTRF
D33	1750000710	S.VARICAP HVC350BTRF
D34	1750000710	S.VARICAP HVC350BTRF
D35	1750000720	S.VARICAP HVC375BTRF
D36	1750000510	S.DIODE UM9401F
D37	1750000510	S.DIODE UM9401F
D38	1750000510	S.DIODE UM9401F
D39	1750000710	S.VARICAP HVC350BTRF
D40	1750000710	S.VARICAP HVC350BTRF
D41	1750000510	S.DIODE UM9401F
D42	1750000510	S.DIODE UM9401F
D43	1750000510	S.DIODE UM9401F
D44	1750000510	S.DIODE UM9401F
D45	1750000510	S.DIODE UM9401F
D46	1750000810	S.DIODE UM9957F/TR
D47	1750000710	S.VARICAP HVC350BTRF
D48	1750000710	S.VARICAP HVC350BTRF
D49	1750000720	S.VARICAP HVC375BTRF
D50	1790001240	S.DIODE MA2S728-(TX)
D51	1750000710	S.VARICAP HVC350BTRF
D52	1790001250	S.DIODE MA2S111-(TX)
D53	1750000710	S.VARICAP HVC350BTRF
D54	1750000710	S.VARICAP HVC350BTRF
D55	1750000510	S.DIODE UM9401F
D57	1790000980	S.DIODE MA742 (TX)

[MAIN UNIT]

REF NO.	ORDER NO.	DESCRIPTION
D58	1790001240	S.DIODE MA2S728-(TX)
D59	1720000240	S.DIODE 1SV172 (TE85R)
D60	1720000240	S.DIODE 1SV172 (TE85R)
D61	1790000980	S.DIODE MA742 (TX)
D62	1790001260	S.DIODE MA2S077-(TX)
D63	1790001260	S.DIODE MA2S077-(TX)
D64	1790001260	S.DIODE MA2S077-(TX)
D65	1790001250	S.DIODE MA2S111-(TX)
D66	1750000550	S.DIODE 1SS355 TE-17
D67	1790001260	S.DIODE MA2S077-(TX)
D68	1750000510	S.DIODE UM9401F
D70	1730002340	S.ZENER MA8047-M (TX)
D71	1790000980	S.DIODE MA742 (TX)
D72	1750000720	S.VARICAP HVC375BTRF
D73	1750000720	S.VARICAP HVC375BTRF
D77	1790001620	S.DIODE 1SV308 (TPL3)
D78	1790001620	S.DIODE 1SV308 (TPL3)
D81	1790001240	S.DIODE MA2S728-(TX)
D82	1790001240	S.DIODE MA2S728-(TX)
D83	1790001240	S.DIODE MA2S728-(TX)
D1008	1750000370	S.DIODE DA221 TL
D1014	1750000830	S.VARICAP HVC362TRF
D1015	1750000830	S.VARICAP HVC362TRF
D1016	1750000720	S.VARICAP HVC375BTRF
D1017	1750000720	S.VARICAP HVC375BTRF
D1018	1720000790	S.VARICAP HVC321B1TRF
D1021	1750000370	S.DIODE DA221 TL
D1022	1750000370	S.DIODE DA221 TL
D1023	1790001260	S.DIODE MA2S077-(TX)
D1024	1790001260	S.DIODE MA2S077-(TX)
D1026	1790001260	S.DIODE MA2S077-(TX)
D1027	1790001260	S.DIODE MA2S077-(TX)
D1028	1790001260	S.DIODE MA2S077-(TX)
D1038	1790001260	S.DIODE MA2S077-(TX)
D1039	1790001260	S.DIODE MA2S077-(TX)
D1040	1750000520	S.DIODE DAN222TL
D1041	1750000520	S.DIODE DAN222TL
D1042	1790001250	S.DIODE MA2S111-(TX)
D1044	1790001250	S.DIODE MA2S111-(TX)
D1045	1790001250	S.DIODE MA2S111-(TX)
D1046	1790001250	S.DIODE MA2S111-(TX)
D1047	1790001250	S.DIODE MA2S111-(TX)
D1049	1790001260	S.DIODE MA2S077-(TX)
D1053	1790001250	S.DIODE MA2S111-(TX)
D2000	1790000700	DIODE DSA3A1
D2010	1790001250	S.DIODE MA2S111-(TX)
D2011	1730002340	S.ZENER MA8047-M (TX)
D2012	1750000370	S.DIODE DA221 TL
D2029	1790000980	S.DIODE MA742 (TX)
D2030	1730000520	ZENER RD20E B2
D2032	1790001250	S.DIODE MA2S111-(TX)
D2034	1790001250	S.DIODE MA2S111-(TX)
D2035	1790001250	S.DIODE MA2S111-(TX)
D2040	1790001250	S.DIODE MA2S111-(TX)
D2044	1790001250	S.DIODE MA2S111-(TX)
D2045	1790001250	S.DIODE MA2S111-(TX)
D2046	1790001250	S.DIODE MA2S111-(TX)
D2047	1790001250	S.DIODE MA2S111-(TX)
D2048	1790001250	S.DIODE MA2S111-(TX)
D2049	1790001250	S.DIODE MA2S111-(TX)
D2050	1790001250	S.DIODE MA2S111-(TX)
D2051	1790001620	S.DIODE 1SV308 (TPL3)
D2052	1790001620	S.DIODE 1SV308 (TPL3)
D2053	1790001620	S.DIODE 1SV308 (TPL3)
D2054	1790001620	S.DIODE 1SV308 (TPL3)
D2055	1790001620	S.DIODE 1SV308 (TPL3)
D2056	1790001620	S.DIODE 1SV308 (TPL3)
D2057	1790001620	S.DIODE 1SV308 (TPL3)
D2058	1790001620	S.DIODE 1SV308 (TPL3)
D2059	1790001620	S.DIODE 1SV308 (TPL3)
D2060	1790001620	S.DIODE 1SV308 (TPL3)
D2061	1790001620	S.DIODE 1SV308 (TPL3)
D2062	1790001620	S.DIODE 1SV308 (TPL3)
D2063	1790001620	S.DIODE 1SV308 (TPL3)
D2064	1790001620	S.DIODE 1SV308 (TPL3)
D2065	1790001620	S.DIODE 1SV308 (TPL3)
D2066	1790001620	S.DIODE 1SV308 (TPL3)
D2067	1790001620	S.DIODE 1SV308 (TPL3)
D2068	1790001620	S.DIODE 1SV308 (TPL3)
D2069	1790001250	S.DIODE MA2S111-(TX)
D2070	1750000510	S.DIODE UM9401F
D2071	1790001250	S.DIODE MA2S111-(TX)

[EUR] only
[ITA] only
[ITA] only

S.=Surface mount

[MAIN UNIT]

REF NO.	ORDER NO.	DESCRIPTION	
F11000	2020001270	CERAMIC	CFWLB450KE2A-B0
F11001	2020001460	CERAMIC	CFWLA450KHFA-B0
F11002	2020000920	CERAMIC	CFWLB455KEFA-B0
F11003	2010002550	S.MONOLITHIC	FL-342 (38.85 MHz)
F11004	2010002560	S.MONOLITHIC	FL-344 (46.05 MHz)
X1001	6070000200	DISCRIMINATOR	CDBLA450KCAY24-B0
X1002	6070000230	DISCRIMINATOR	CDBLA455KCAY24-B0
X1003	6050011330	S.XTAL	CR-723 (45.595 MHz)
X2001	60500009520	S.XTAL	CR-520 (19.6608 MHz+)
L2	6200008270	S.COIL	0.26-1.0-5TL 17N
L4	6200008270	S.COIL	0.26-1.0-5TL 17N
L5	6200008270	S.COIL	0.26-1.0-5TL 17N
L6	6200008270	S.COIL	0.26-1.0-5TL 17N
L10	6200005660	S.COIL	ELJRE 10NG-F
L11	6200004960	S.COIL	NL 252018T-R33J
L13	6200008270	S.COIL	0.26-1.0-5TL 17N
L15	6200008270	S.COIL	0.26-1.0-5TL 17N
L16	6200005650	S.COIL	ELJRE 8N2Z-F
L19	6200005680	S.COIL	ELJRE 15NG-F
L20	6200005670	S.COIL	ELJRE 12NG-F
L21	6200008270	S.COIL	0.26-1.0-5TL 17N
L22	6200008270	S.COIL	0.26-1.0-5TL 17N
L23	6200008270	S.COIL	0.26-1.0-5TL 17N
L24	6200008270	S.COIL	0.26-1.0-5TL 17N
L25	6200002640	S.COIL	NL 252018T-R15J
L26	6200003950	S.COIL	HF50ACC 322513-T
L27	6200007740	S.COIL	LQW2BHN47NJ01L
L32	6200003950	S.COIL	HF50ACC 322513-T
L33	6200010170	S.COIL	AS080447-33N
L34	6190001520	S.COIL	ZBFS5101-PT
L35	6110001690	COIL	LA-255
L37	6200002420	S.COIL	NL 252018T-068J
L38	6200002590	S.COIL	NL 252018T-039J
L39	6200002420	S.COIL	NL 252018T-068J
L40	6200002590	S.COIL	NL 252018T-039J
L44	6170000180	COIL	LW-19
L46	6200002580	S.COIL	NL 252018T-033J
L48	6200003560	S.COIL	NL 252018T-018J
L50	6200002630	S.COIL	NL 252018T-R10J
L52	6200002630	S.COIL	NL 252018T-R10J
L53	6170000180	COIL	LW-19
L54	6200010060	S.COIL	AS080647-56N
L55	6200008170	S.COIL	0.35-1.6-8TL 54N
L57	6200007650	S.COIL	LL1608-FH82NJ
L59	6200007650	S.COIL	LL1608-FH82NJ
L60	6200010040	S.COIL	AS100340-10N
L61	6200010150	S.COIL	AS080340-15N
L63	6200003560	S.COIL	NL 252018T-018J
L65	6200002580	S.COIL	NL 252018T-033J
L66	6200002390	S.COIL	LQW31HN64NJ01L
L67	6200002370	S.COIL	LQW31HN39NJ01L
L68	6200002390	S.COIL	LQW31HN64NJ01L
L69	6200002370	S.COIL	LQW31HN39NJ01L
L70	6200010150	S.COIL	AS080340-15N
L71	6200010060	S.COIL	AS080647-56N
L72	6200009200	S.COIL	0.45-1.5-4TL
L73	6200010150	S.COIL	AS080340-15N
L76	6200010060	S.COIL	AS080647-56N
L77	6200010070	S.COIL	AS080747-68N
L78	6200010150	S.COIL	AS080340-15N
L79	6200010330	S.COIL	C2012C-R18G
L80	6200010050	S.COIL	AS080547-47N
L81	6200010150	S.COIL	AS080340-15N
L82	6200009890	S.COIL	C2012C-82NG
L84	6200010320	S.COIL	C2012C-R15G
L85	6170000180	COIL	LW-19
L86	6170000180	COIL	LW-19
L87	6200005670	S.COIL	ELJRE 12NG-F
L88	6200005670	S.COIL	ELJRE 12NG-F
L90	6200005740	S.COIL	ELJRE 47NG-F
L91	6200005740	S.COIL	ELJRE 47NG-F
L93	6200007770	S.COIL	LQW2BHN R12K-T
L94	6200005670	S.COIL	ELJRE 12NG-F
L1000	6200004470	S.COIL	MLF1608D R12K-T
L1001	6200005190	S.COIL	MLF1608D R56K-T
L1002	6200007620	S.COIL	LL1608-FH47NJ
L1004	6200005740	S.COIL	ELJRE 47NG-F
L1006	6200002610	S.COIL	NL 252018T-R47J

[MAIN UNIT]

REF NO.	ORDER NO.	DESCRIPTION	
L1007	6200002610	S.COIL	NL 252018T-R47J
L1010	6200002360	S.COIL	LQW31HN33NJ01L
L1012	6200002330	S.COIL	LQW31HN15NJ01L
L1014	6200002640	S.COIL	NL 252018T-R15J
L1016	6200002640	S.COIL	NL 252018T-R15J
L1017	6200005730	S.COIL	ELJRE 39NG-F
L1018	6200005680	S.COIL	ELJRE 15NG-F
L1020	6200005670	S.COIL	ELJRE 12NG-F
L1021	6200007550	S.COIL	LL1608-FH12NJ
L1023	6200005700	S.COIL	ELJRE 22NG-F
L1034	6200007580	S.COIL	LL1608-FH22NJ
L1035	6200007580	S.COIL	LL1608-FH22NJ
L1036	6200007530	S.COIL	LL1608-FH8N2J
L1038	6200007580	S.COIL	LL1608-FH22NJ
L1042	6200004730	S.COIL	MLF1608A 1R2K-T
L1045	6200007610	S.COIL	LL1608-FH39NJ
L1046	6200007610	S.COIL	LL1608-FH39NJ
L1048	6200007570	S.COIL	LL1608-FH18NJ
L1049	6200007570	S.COIL	LL1608-FH18NJ
L1050	6200005680	S.COIL	ELJRE 15NG-F
L1051	6200003550	S.COIL	MLF1608A 4R7K-T
L1052	6200003550	S.COIL	MLF1608A 4R7K-T
L1053	6200003550	S.COIL	MLF1608A 4R7K-T
L1054	6200003550	S.COIL	MLF1608A 4R7K-T
L1055	6200003550	S.COIL	MLF1608A 4R7K-T
L1056	6200003550	S.COIL	MLF1608A 4R7K-T
L1057	6200003550	S.COIL	MLF1608A 4R7K-T
L1058	6200003550	S.COIL	MLF1608A 4R7K-T
L1059	6200010060	S.COIL	AS080647-56N
L1060	6200007700	S.COIL	LQW2BHN22NJ01L
L1061	6200008090	S.COIL	LQW2BHN68NJ01L
L1062	6200006710	S.COIL	MLF1608E 5R6K 5.6U
L1063	6200006980	S.COIL	ELJRE R10G-F
L1064	6200006670	S.COIL	ELJRE 68NG-F
L1065	6200006990	S.COIL	ELJRE 56NG-F
L1066	6200005740	S.COIL	ELJRE 47NG-F
L1067	6200003550	S.COIL	MLF1608A 4R7K-T
L1068	6200006980	S.COIL	ELJRE R10G-F
L1069	6200005740	S.COIL	ELJRE 47NG-F
L1070	6200005640	S.COIL	ELJRE 6N8Z-F
L1071	6200005720	S.COIL	ELJRE 33NG-F
L1072	6200005700	S.COIL	ELJRE 22NG-F
L1073	6200005720	S.COIL	ELJRE 33NG-F
L1074	6200005720	S.COIL	ELJRE 33NG-F
L1077	6200009990	S.COIL	C2012C-R22G
L1078	6200009990	S.COIL	C2012C-R22G
L1079	6200005690	S.COIL	ELJRE 18NG-F
L1080	6200005730	S.COIL	ELJRE 39NG-F
R1	7030003440	S.RESISTOR	ERJ3GEYJ 102 V (1 kΩ)
R2	7030003440	S.RESISTOR	ERJ3GEYJ 102 V (1 kΩ)
R3	7030003440	S.RESISTOR	ERJ3GEYJ 102 V (1 kΩ)
R4	7030003640	S.RESISTOR	ERJ3GEYJ 473 V (47 kΩ)
R5	7030003640	S.RESISTOR	ERJ3GEYJ 473 V (47 kΩ)
R6	7030003640	S.RESISTOR	ERJ3GEYJ 473 V (47 kΩ)
R7	7030003480	S.RESISTOR	ERJ3GEYJ 222 V (2.2 kΩ)
R8	7030003480	S.RESISTOR	ERJ3GEYJ 222 V (2.2 kΩ)
R11	7030003380	S.RESISTOR	ERJ3GEYJ 331 V (330 Ω)
R12	7030003270	S.RESISTOR	ERJ3GEYJ 390 V (39 Ω)
R14	7030003680	S.RESISTOR	ERJ3GEYJ 104 V (100 kΩ)
R15	7030003680	S.RESISTOR	ERJ3GEYJ 104 V (100 kΩ)
R18	7030003420	S.RESISTOR	ERJ3GEYJ 681 V (680 Ω)
R19	7030003400	S.RESISTOR	ERJ3GEYJ 471 V (470 Ω)
R21	7030003320	S.RESISTOR	ERJ3GEYJ 101 V (100 Ω)
R22	7030003680	S.RESISTOR	ERJ3GEYJ 104 V (100 kΩ)
R23	7030003680	S.RESISTOR	ERJ3GEYJ 104 V (100 kΩ)
R24	7030003480	S.RESISTOR	ERJ3GEYJ 222 V (2.2 kΩ)
R27	7030003520	S.RESISTOR	ERJ3GEYJ 472 V (4.7 kΩ)
R28	7030003400	S.RESISTOR	ERJ3GEYJ 471 V (470 Ω)
R31	7030003280	S.RESISTOR	ERJ3GEYJ 470 V (47 Ω)
R32	7030003280	S.RESISTOR	ERJ3GEYJ 470 V (47 Ω)
R33	7030000220	S.RESISTOR	MCR10EZJH 47 Ω (470)
R38	7030003260	S.RESISTOR	ERJ3GEYJ 330 V (33 Ω)
R39	7030003260	S.RESISTOR	ERJ3GEYJ 330 V (33 Ω)
R40	7030003670	S.RESISTOR	ERJ3GEYJ 823 V (82 kΩ)
R41	7030003670	S.RESISTOR	ERJ3GEYJ 823 V (82 kΩ)
R43	7030003640	S.RESISTOR	ERJ3GEYJ 473 V (47 kΩ)
R44	7030003560	S.RESISTOR	ERJ3GEYJ 103 V (10 kΩ)
R45	7030003640	S.RESISTOR	ERJ3GEYJ 473 V (47 kΩ)
R47	7030003560	S.RESISTOR	ERJ3GEYJ 103 V (10 kΩ)
R48	7030000340	S.RESISTOR	MCR10EZJH 470 Ω (471)

S.=Surface mount

[MAIN UNIT]

REF NO.	ORDER NO.	DESCRIPTION
R51	7030003490	S.RESISTOR ERJ3GEYJ 272 V (2.7 kΩ)
R52	7030003480	S.RESISTOR ERJ3GEYJ 222 V (2.2 kΩ)
R53	7030003440	S.RESISTOR ERJ3GEYJ 102 V (1 kΩ)
R54	7030000280	S.RESISTOR MCR10EZJH 150 Ω (151)
R55	7030003680	S.RESISTOR ERJ3GEYJ 104 V (100 kΩ)
R56	7030003680	S.RESISTOR ERJ3GEYJ 104 V (100 kΩ)
R58	7030003720	S.RESISTOR ERJ3GEYJ 224 V (220 kΩ)
R59	7030003740	S.RESISTOR ERJ3GEYJ 334 V (330 kΩ)
R61	7030003560	S.RESISTOR ERJ3GEYJ 103 V (10 kΩ)
R62	7030003710	S.RESISTOR ERJ3GEYJ 184 V (180 kΩ)
R63	7030003620	S.RESISTOR ERJ3GEYJ 333 V (33 kΩ)
R64	7030000340	S.RESISTOR MCR10EZJH 470 Ω (471)
R65	7030003480	S.RESISTOR ERJ3GEYJ 222 V (2.2 kΩ)
R68	7030003440	S.RESISTOR ERJ3GEYJ 102 V (1 kΩ)
R69	7030003440	S.RESISTOR ERJ3GEYJ 102 V (1 kΩ)
R70	7030003530	S.RESISTOR ERJ3GEYJ 562 V (5.6 kΩ)
R71	7030003560	S.RESISTOR ERJ3GEYJ 103 V (10 kΩ)
R72	7030003560	S.RESISTOR ERJ3GEYJ 103 V (10 kΩ)
R73	7030003340	S.RESISTOR ERJ3GEYJ 151 V (150 Ω)
R74	7030003340	S.RESISTOR ERJ3GEYJ 151 V (150 Ω)
R75	7030000270	S.RESISTOR MCR10EZJH 120 Ω (121)
R76	7030003520	S.RESISTOR ERJ3GEYJ 472 V (4.7 kΩ)
R77	7030004050	S.RESISTOR ERJ3GEYJ 1R0 V (1 Ω)
R78	7030000190	S.RESISTOR MCR10EZJH 27 Ω (270)
R79	7030006270	S.RESISTOR ERJ12YJ221U (220 Ω)
R80	7030000230	S.RESISTOR MCR10EZJH 56 Ω (560)
R81	7030000120	S.RESISTOR MCR10EZJH 6.8 Ω (6R8)
R82	7030003280	S.RESISTOR ERJ3GEYJ 470 V (47 Ω)
R83	7030003320	S.RESISTOR ERJ3GEYJ 101 V (100 Ω)
R84	7030000190	S.RESISTOR MCR10EZJH 27 Ω (270)
R85	7030003590	S.RESISTOR ERJ3GEYJ 183 V (18 kΩ)
R86	7030003560	S.RESISTOR ERJ3GEYJ 103 V (10 kΩ)
R87	7030003320	S.RESISTOR ERJ3GEYJ 101 V (100 Ω)
R89	7030003490	S.RESISTOR ERJ3GEYJ 272 V (2.7 kΩ)
R90	7030003490	S.RESISTOR ERJ3GEYJ 272 V (2.7 kΩ)
R91	7030000340	S.RESISTOR MCR10EZJH 470 Ω (471)
R92	7030003480	S.RESISTOR ERJ3GEYJ 222 V (2.2 kΩ)
R93	7030003480	S.RESISTOR ERJ3GEYJ 222 V (2.2 kΩ)
R94	7030003480	S.RESISTOR ERJ3GEYJ 222 V (2.2 kΩ)
R95	7030003480	S.RESISTOR ERJ3GEYJ 222 V (2.2 kΩ)
R96	7030003560	S.RESISTOR ERJ3GEYJ 103 V (10 kΩ)
R97	7030003680	S.RESISTOR ERJ3GEYJ 104 V (100 kΩ)
R98	7030003680	S.RESISTOR ERJ3GEYJ 104 V (100 kΩ)
R99	7030003680	S.RESISTOR ERJ3GEYJ 104 V (100 kΩ)
R100	7030003680	S.RESISTOR ERJ3GEYJ 104 V (100 kΩ)
R102	7030006070	S.RESISTOR ERJ12YJ101U (100 Ω)
R103	7030003440	S.RESISTOR ERJ3GEYJ 102 V (1 kΩ)
R104	7030003680	S.RESISTOR ERJ3GEYJ 104 V (100 kΩ)
R105	7030003680	S.RESISTOR ERJ3GEYJ 104 V (100 kΩ)
R106	7030003320	S.RESISTOR ERJ3GEYJ 101 V (100 Ω)
R107	7030003320	S.RESISTOR ERJ3GEYJ 101 V (100 Ω)
R108	7030008350	S.RESISTOR ERJ12YJ390U
R109	7030003280	S.RESISTOR ERJ3GEYJ 470 V (47 Ω)
R110	7030003280	S.RESISTOR ERJ3GEYJ 470 V (47 Ω)
R111	7030003560	S.RESISTOR ERJ3GEYJ 103 V (10 kΩ)
R112	7030003340	S.RESISTOR ERJ3GEYJ 151 V (150 Ω)
R113	7030003270	S.RESISTOR ERJ3GEYJ 390 V (39 Ω)
R114	7030003670	S.RESISTOR ERJ3GEYJ 823 V (82 kΩ)
R115	7030003610	S.RESISTOR ERJ3GEYJ 273 V (27 kΩ)
R117	7030003710	S.RESISTOR ERJ3GEYJ 184 V (180 kΩ)
R118	7030003560	S.RESISTOR ERJ3GEYJ 103 V (10 kΩ)
R120	7030003560	S.RESISTOR ERJ3GEYJ 103 V (10 kΩ)
R123	7030003710	S.RESISTOR ERJ3GEYJ 184 V (180 kΩ)
R124	7030003630	S.RESISTOR ERJ3GEYJ 393 V (39 kΩ)
R125	7030003840	S.RESISTOR ERJ3GEYJ 225 V (2.2 MΩ)
R126	7030003630	S.RESISTOR ERJ3GEYJ 393 V (39 kΩ)
R127	7030003840	S.RESISTOR ERJ3GEYJ 225 V (2.2 MΩ)
R129	7030003680	S.RESISTOR ERJ3GEYJ 104 V (100 kΩ)
R130	7030003680	S.RESISTOR ERJ3GEYJ 104 V (100 kΩ)
R131	7030003680	S.RESISTOR ERJ3GEYJ 104 V (100 kΩ)
R132	7030003680	S.RESISTOR ERJ3GEYJ 104 V (100 kΩ)
R133	7030003520	S.RESISTOR ERJ3GEYJ 472 V (4.7 kΩ)
R134	7030003680	S.RESISTOR ERJ3GEYJ 104 V (100 kΩ)
R135	7030003680	S.RESISTOR ERJ3GEYJ 104 V (100 kΩ)
R137	7030000320	S.RESISTOR MCR10EZJH 330 Ω (331)
R138	7030000500	S.RESISTOR MCR10EZJH 10 kΩ
R139	7030003580	S.RESISTOR ERJ3GEYJ 153 V (15 kΩ)
R140	7030003560	S.RESISTOR ERJ3GEYJ 103 V (10 kΩ)
R141	7030003480	S.RESISTOR ERJ3GEYJ 222 V (2.2 kΩ)
R142	7030003440	S.RESISTOR ERJ3GEYJ 102 V (1 kΩ)
R143	7030000500	S.RESISTOR MCR10EZJH 10 kΩ
R144	7030000380	S.RESISTOR MCR10EZJH 1 kΩ

[MAIN UNIT]

REF NO.	ORDER NO.	DESCRIPTION
R145	7030003580	S.RESISTOR ERJ3GEYJ 153 V (15 kΩ)
R147	7030003480	S.RESISTOR ERJ3GEYJ 222 V (2.2 kΩ)
R148	7030003440	S.RESISTOR ERJ3GEYJ 102 V (1 kΩ)
R149	7030004050	S.RESISTOR ERJ3GEYJ 1R0 V (1 Ω)
R150	7030003330	S.RESISTOR ERJ3GEYJ 121 V (120 Ω)
R151	7030003560	S.RESISTOR ERJ3GEYJ 103 V (10 kΩ)
R152	7030004050	S.RESISTOR ERJ3GEYJ 1R0 V (1 Ω)
R154	7030003520	S.RESISTOR ERJ3GEYJ 472 V (4.7 kΩ)
R155	7030003320	S.RESISTOR ERJ3GEYJ 101 V (100 Ω)
R156	7030003320	S.RESISTOR ERJ3GEYJ 101 V (100 Ω)
R157	7030003680	S.RESISTOR ERJ3GEYJ 104 V (100 kΩ)
R158	7030003640	S.RESISTOR ERJ3GEYJ 473 V (47 kΩ)
R159	7030003560	S.RESISTOR ERJ3GEYJ 103 V (10 kΩ)
R160	7030003640	S.RESISTOR ERJ3GEYJ 473 V (47 kΩ)
R161	7030003640	S.RESISTOR ERJ3GEYJ 473 V (47 kΩ)
R162	7030003640	S.RESISTOR ERJ3GEYJ 473 V (47 kΩ)
R163	7030003200	S.RESISTOR ERJ3GEYJ 100 V (10 Ω)
R164	7030003200	S.RESISTOR ERJ3GEYJ 100 V (10 Ω)
R165	7030000360	S.RESISTOR MCR10EZJH 680 Ω (681)
R166	7030000360	S.RESISTOR MCR10EZJH 680 Ω (681)
R172	7030003640	S.RESISTOR ERJ3GEYJ 473 V (47 kΩ)
R173	7030003560	S.RESISTOR ERJ3GEYJ 103 V (10 kΩ)
R174	7030003440	S.RESISTOR ERJ3GEYJ 102 V (1 kΩ)
R175	7030003680	S.RESISTOR ERJ3GEYJ 104 V (100 kΩ)
R176	7030003680	S.RESISTOR ERJ3GEYJ 104 V (100 kΩ)
R177	7030003670	S.RESISTOR ERJ3GEYJ 823 V (82 kΩ)
R178	7030003270	S.RESISTOR ERJ3GEYJ 390 V (39 Ω)
R179	7030003340	S.RESISTOR ERJ3GEYJ 151 V (150 Ω)
R180	7030003340	S.RESISTOR ERJ3GEYJ 151 V (150 Ω)
R181	7030003670	S.RESISTOR ERJ3GEYJ 823 V (82 kΩ)
R182	7030003320	S.RESISTOR ERJ3GEYJ 101 V (100 Ω)
R183	7030003220	S.RESISTOR ERJ3GEYJ 150 V (15 Ω)
R184	7030003380	S.RESISTOR ERJ3GEYJ 331 V (330 Ω)
R185	7030003380	S.RESISTOR ERJ3GEYJ 331 V (330 Ω)
R189	7030003630	S.RESISTOR ERJ3GEYJ 393 V (39 kΩ)
R190	7030003630	S.RESISTOR ERJ3GEYJ 393 V (39 kΩ)
R191	7030003320	S.RESISTOR ERJ3GEYJ 101 V (100 Ω)
R192	7030003200	S.RESISTOR ERJ3GEYJ 100 V (10 Ω)
R193	7030003520	S.RESISTOR ERJ3GEYJ 472 V (4.7 kΩ)
R194	7030003440	S.RESISTOR ERJ3GEYJ 102 V (1 kΩ)
R195	7030003380	S.RESISTOR ERJ3GEYJ 331 V (330 Ω)
R196	7030003220	S.RESISTOR ERJ3GEYJ 150 V (15 Ω)
R197	7030003380	S.RESISTOR ERJ3GEYJ 331 V (330 Ω)
R198	7030003380	S.RESISTOR ERJ3GEYJ 331 V (330 Ω)
R199	7030003220	S.RESISTOR ERJ3GEYJ 150 V (15 Ω)
R200	7030003380	S.RESISTOR ERJ3GEYJ 331 V (330 Ω)
R1003	7030003680	S.RESISTOR ERJ3GEYJ 104 V (100 kΩ)
R1004	7030003680	S.RESISTOR ERJ3GEYJ 104 V (100 kΩ)
R1005	7030003510	S.RESISTOR ERJ3GEYJ 392 V (39 kΩ)
R1006	7030003580	S.RESISTOR ERJ3GEYJ 153 V (15 kΩ)
R1009	7030003630	S.RESISTOR ERJ3GEYJ 393 V (39 kΩ)
R1010	7030003320	S.RESISTOR ERJ3GEYJ 101 V (100 Ω)
R1012	7030003660	S.RESISTOR ERJ3GEYJ 683 V (68 kΩ)
R1013	7030003400	S.RESISTOR ERJ3GEYJ 471 V (470 Ω)
R1015	7030003660	S.RESISTOR ERJ3GEYJ 683 V (68 kΩ)
R1016	7030003680	S.RESISTOR ERJ3GEYJ 104 V (100 kΩ)
R1017	7030003680	S.RESISTOR ERJ3GEYJ 104 V (100 kΩ)
R1018	7030003680	S.RESISTOR ERJ3GEYJ 104 V (100 kΩ)
R1019	7030003450	S.RESISTOR ERJ3GEYJ 122 V (1.2 kΩ)
R1020	7030003680	S.RESISTOR ERJ3GEYJ 104 V (100 kΩ)
R1021	7030003450	S.RESISTOR ERJ3GEYJ 122 V (1.2 kΩ)
R1022	7030003820	S.RESISTOR ERJ3GEYJ 155 V (1.5 MΩ)
R1023	7030003820	S.RESISTOR ERJ3GEYJ 155 V (1.5 MΩ)
R1024	7030003700	S.RESISTOR ERJ3GEYJ 154 V (150 kΩ)
R1025	7030003560	S.RESISTOR ERJ3GEYJ 103 V (10 kΩ)
R1026	7030003720	S.RESISTOR ERJ3GEYJ 224 V (220 kΩ)
R1027	7030003560	S.RESISTOR ERJ3GEYJ 103 V (10 kΩ)
R1028	7030003560	S.RESISTOR ERJ3GEYJ 103 V (10 kΩ)
R1029	7030003560	S.RESISTOR ERJ3GEYJ 103 V (10 kΩ)
R1030	7030003530	S.RESISTOR ERJ3GEYJ 562 V (5.6 kΩ)
R1031	7030003580	S.RESISTOR ERJ3GEYJ 153 V (15 kΩ)
R1032	7030003580	S.RESISTOR ERJ3GEYJ 153 V (15 kΩ)
R1033	7030003500	S.RESISTOR ERJ3GEYJ 332 V (3.3 kΩ)
R1034	7030003500	S.RESISTOR ERJ3GEYJ 332 V (3.3 kΩ)
R1035	7030003580	S.RESISTOR ERJ3GEYJ 153 V (15 kΩ)
R1036	7030003600	S.RESISTOR ERJ3GEYJ 223 V (22 kΩ)
R1037	7030003600	S.RESISTOR ERJ3GEYJ 223 V (22 kΩ)
R1038	7030003640	S.RESISTOR ERJ3GEYJ 473 V (47 kΩ)
R1039	7030003640	S.RESISTOR ERJ3GEYJ 473 V (47 kΩ)
R1040	7030003580	S.RESISTOR ERJ3GEYJ 153 V (15 kΩ)
R1041	7030003600	S.RESISTOR ERJ3GEYJ 223 V (22 kΩ)
R1042	7030003680	S.RESISTOR ERJ3GEYJ 104 V (100 kΩ)

S.=Surface mount

[MAIN UNIT]

REF NO.	ORDER NO.	DESCRIPTION
C2060	4030011600	S.CERAMIC C1608 JB 1E 104K-T
C2061	4510004630	S.ELECTROLYTIC ECEV1CA100SR
C2062	4510004630	S.ELECTROLYTIC ECEV1CA100SR
C2063	4510004630	S.ELECTROLYTIC ECEV1CA100SR
C2064	4030008680	S.CERAMIC C2012 JF 1C 105Z-T
C2065	4030008680	S.CERAMIC C2012 JF 1C 105Z-T
C2066	4510004630	S.ELECTROLYTIC ECEV1CA100SR
C2067	4030007090	S.CERAMIC C1608 CH 1H 470J-T
C2068	4030007090	S.CERAMIC C1608 CH 1H 470J-T
C2069	4030007090	S.CERAMIC C1608 CH 1H 470J-T
C2070	4030007090	S.CERAMIC C1608 CH 1H 470J-T
C2072	4030011600	S.CERAMIC C1608 JB 1E 104K-T
C2073	4030011600	S.CERAMIC C1608 JB 1E 104K-T
C2074	4030006860	S.CERAMIC C1608 JB 1H 102K-T
C2075	4030007090	S.CERAMIC C1608 CH 1H 470J-T
C2076	4030011600	S.CERAMIC C1608 JB 1E 104K-T
C2077	4030008900	S.CERAMIC C1608 JB 1H 333K-T
C2078	4030006860	S.CERAMIC C1608 JB 1H 102K-T
C2079	4030009590	S.CERAMIC C2012 JF 1C 225Z-T
C2081	4030011600	S.CERAMIC C1608 JB 1E 104K-T
C2082	4030008680	S.CERAMIC C2012 JF 1C 105Z-T
C2083	4030008680	S.CERAMIC C2012 JF 1C 105Z-T
C2084	4030008680	S.CERAMIC C2012 JF 1C 105Z-T
C2085	4030008680	S.CERAMIC C2012 JF 1C 105Z-T
C2086	4550006760	S.TANTALUM TEMSVB2 1A 336M-8R
C2088	4030006860	S.CERAMIC C1608 JB 1H 102K-T
C2094	4030012600	S.CERAMIC C2012 JB 1A 105M-T
C2095	4030006860	S.CERAMIC C1608 JB 1H 102K-T
C2096	4030006860	S.CERAMIC C1608 JB 1H 102K-T
C2097	4030009350	S.CERAMIC C1608 CH 1H 3R5B-T
C2098	4030006960	S.CERAMIC C1608 CH 1H 050C-T
C2099	4030006940	S.CERAMIC C1608 CH 1H 030C-T
C2100	4030006860	S.CERAMIC C1608 JB 1H 102K-T
C2101	4030006910	S.CERAMIC C1608 CH 1H 0R5C-T
C2102	4030006950	S.CERAMIC C1608 CH 1H 040C-T
C2103	4030006860	S.CERAMIC C1608 JB 1H 102K-T
C2104	4030007000	S.CERAMIC C1608 CH 1H 090D-T
C2105	4030006860	S.CERAMIC C1608 JB 1H 102K-T
C2106	4030006910	S.CERAMIC C1608 CH 1H 0R5C-T
C2107	4030006940	S.CERAMIC C1608 CH 1H 030C-T
C2108	4030006860	S.CERAMIC C1608 JB 1H 102K-T
C2109	4030006860	S.CERAMIC C1608 JB 1H 102K-T
C2110	4030009550	S.CERAMIC C1608 CH 1H 2R5B-T
C2111	4030006860	S.CERAMIC C1608 JB 1H 102K-T
C2112	4030006910	S.CERAMIC C1608 CH 1H 0R5C-T
C2113	4030009350	S.CERAMIC C1608 CH 1H 3R5B-T
C2114	4030006860	S.CERAMIC C1608 JB 1H 102K-T
C2115	4030006990	S.CERAMIC C1608 CH 1H 080D-T
C2116	4030006860	S.CERAMIC C1608 JB 1H 102K-T
C2117	4030006910	S.CERAMIC C1608 CH 1H 0R5C-T
C2118	4030009550	S.CERAMIC C1608 CH 1H 2R5B-T
C2119	4030006860	S.CERAMIC C1608 JB 1H 102K-T
C2120	4030006940	S.CERAMIC C1608 CH 1H 030C-T
C2121	4030006940	S.CERAMIC C1608 CH 1H 030C-T
C2122	4030006860	S.CERAMIC C1608 JB 1H 102K-T
C2123	4030006860	S.CERAMIC C1608 JB 1H 102K-T
C2124	4030006860	S.CERAMIC C1608 JB 1H 102K-T
C2125	4030011180	S.CERAMIC GRM31M2C2H220JV01L
C2126	4030011210	S.CERAMIC GRM31M2C2H330JV01L
C2127	4030006860	S.CERAMIC C1608 JB 1H 102K-T
C2128	4030007170	S.CERAMIC C1608 CH 1H 221J-T
C2129	4030007170	S.CERAMIC C1608 CH 1H 221J-T
C2130	4030006860	S.CERAMIC C1608 JB 1H 102K-T
C2131	4030006860	S.CERAMIC C1608 JB 1H 102K-T
C2132	4030006860	S.CERAMIC C1608 JB 1H 102K-T
C2133	4030017200	S.CERAMIC GRM31BR32J102KY01L
C2134	4030006860	S.CERAMIC C1608 JB 1H 102K-T
C2135	4030006860	S.CERAMIC C1608 JB 1H 102K-T
C2136	4030007070	S.CERAMIC C1608 CH 1H 330J-T
C2137	4030006860	S.CERAMIC C1608 JB 1H 102K-T
C2138	4030007070	S.CERAMIC C1608 CH 1H 330J-T
C2139	4030006860	S.CERAMIC C1608 JB 1H 102K-T
C2140	4030006950	S.CERAMIC C1608 CH 1H 040C-T
C2141	4030006930	S.CERAMIC C1608 CH 1H 020C-T
C2142	4030006960	S.CERAMIC C1608 CH 1H 050C-T
C2143	4030006860	S.CERAMIC C1608 JB 1H 102K-T
C2144	4030006950	S.CERAMIC C1608 CH 1H 040C-T
C2145	4030006860	S.CERAMIC C1608 JB 1H 102K-T
C2146	4030006940	S.CERAMIC C1608 CH 1H 030C-T
C2147	4030006860	S.CERAMIC C1608 JB 1H 102K-T
C2148	4030006920	S.CERAMIC C1608 CH 1H 010C-T
C2149	4030006860	S.CERAMIC C1608 JB 1H 102K-T

[MAIN UNIT]

REF NO.	ORDER NO.	DESCRIPTION
C2150	4030006860	S.CERAMIC C1608 JB 1H 102K-T
C2151	4030006970	S.CERAMIC C1608 CH 1H 060D-T
C2152	4030006920	S.CERAMIC C1608 CH 1H 010C-T
C2153	4030006960	S.CERAMIC C1608 CH 1H 050C-T
C2154	4030006860	S.CERAMIC C1608 JB 1H 102K-T
C2155	4030010780	S.CERAMIC C1608 CH 1H 1R5C-T
C2156	4030006860	S.CERAMIC C1608 JB 1H 102K-T
C2157	4030009510	S.CERAMIC C1608 CH 1H 010B-T
C2158	4030006850	S.CERAMIC C1608 JB 1H 471K-T
C2159	4030006860	S.CERAMIC C1608 JB 1H 102K-T
C2160	4030006860	S.CERAMIC C1608 JB 1H 102K-T
C2161	4030006860	S.CERAMIC C1608 JB 1H 102K-T
C2162	4030006860	S.CERAMIC C1608 JB 1H 102K-T
C2164	4030006860	S.CERAMIC C1608 JB 1H 102K-T
C2165	4030007130	S.CERAMIC C1608 CH 1H 101J-T
C2166	4030011600	S.CERAMIC C1608 JB 1E 104K-T
C2167	4030011600	S.CERAMIC C1608 JB 1E 104K-T
C2168	4030007070	S.CERAMIC C1608 CH 1H 330J-T
C2169	4030006860	S.CERAMIC C1608 JB 1H 102K-T
C2170	4030007070	S.CERAMIC C1608 CH 1H 330J-T
C2171	4030007090	S.CERAMIC C1608 CH 1H 470J-T
C2172	4030006850	S.CERAMIC C1608 JB 1H 471K-T
C2176	4030006900	S.CERAMIC C1608 JB 1H 103K-T
C2180	4030006940	S.CERAMIC C1608 CH 1H 030C-T
C2181	4030006940	S.CERAMIC C1608 CH 1H 030C-T
C2182	4550006250	S.TANTALUM TEMSVA 1A 106M-8L
C2183	4030006980	S.CERAMIC C1608 CH 1H 070D-T
C2184	4030006980	S.CERAMIC C1608 CH 1H 070D-T
C2185	4030008910	S.CERAMIC C1608 JB 1H 393K-T
C2186	4030008910	S.CERAMIC C1608 JB 1H 393K-T
C2187	4030011600	S.CERAMIC C1608 JB 1E 104K-T
C2188	4030012600	S.CERAMIC C2012 JB 1A 105M-T
C2190	4510005860	S.ELECTROLYTIC ECEV1HA2R2SR
C2191	4030008650	S.CERAMIC C1608 JB 1H 332K-T
C2192	4030006900	S.CERAMIC C1608 JB 1H 103K-T
C2193	4030008880	S.CERAMIC C1608 JB 1H 223K-T
C2194	4030007090	S.CERAMIC C1608 CH 1H 470J-T
C2195	4030007090	S.CERAMIC C1608 CH 1H 470J-T
C2196	4030007090	S.CERAMIC C1608 CH 1H 470J-T
C2197	4030007090	S.CERAMIC C1608 CH 1H 470J-T
C2198	4030007090	S.CERAMIC C1608 CH 1H 470J-T
C2199	4550006210	S.TANTALUM ECST1CX106R
C2200	4030006900	S.CERAMIC C1608 JB 1H 103K-T
C2203	4030006860	S.CERAMIC C1608 JB 1H 102K-T
C2204	4030006860	S.CERAMIC C1608 JB 1H 102K-T
C2205	4030006860	S.CERAMIC C1608 JB 1H 102K-T
C2206	4030007040	S.CERAMIC C1608 CH 1H 180J-T
C2207	4030006860	S.CERAMIC C1608 JB 1H 102K-T
C2208	4030011810	S.CERAMIC C1608 CH 1A 224K-T
C2209	4030006860	S.CERAMIC C1608 JB 1H 102K-T
C2210	4030006860	S.CERAMIC C1608 JB 1H 102K-T
C2211	4030006920	S.CERAMIC C1608 CH 1H 010C-T
C2212	4030006920	S.CERAMIC C1608 CH 1H 010C-T
C2213	4030007090	S.CERAMIC C1608 CH 1H 470J-T
C2214	4030006860	S.CERAMIC C1608 JB 1H 102K-T
C2215	4030006860	S.CERAMIC C1608 JB 1H 102K-T
C2216	4030011600	S.CERAMIC C1608 JB 1E 104K-T
C2217	4030006900	S.CERAMIC C1608 JB 1H 103K-T
C2218	4030006880	S.CERAMIC C1608 JB 1H 472K-T
C2219	4030006880	S.CERAMIC C1608 JB 1H 472K-T
RL1	6330001700	RELAY ATQ209
J1	6510014960	S.CONNECTOR B2B-ZR-SM3-TF
J2001	6510023110	CONNECTOR 3008L-8P8C
J2003	6510023160	CONNECTOR DN-508B-6
J2004	6450002220	CONNECTOR PJ-0008P-5
J2005	6450001440	CONNECTOR HSJ1403-01-010
J2006	6510023170	CONNECTOR 3008L-6P6C
J2007	6510014960	S.CONNECTOR B2B-ZR-SM3-TF
W2	8900010980	CABLE OPC-1131
W2001	7030000010	S.JUMPER MCR10EZHZ JPW (000)
W2002	7030003860	S.JUMPER ERJ3GE JPW V
W2003	7030003860	S.JUMPER ERJ3GE JPW V
W2005	7030003860	S.JUMPER ERJ3GE JPW V
W2008	7030008240	S.JUMPER ERJ12YJ0R00U
W2010	7030008240	S.JUMPER ERJ12YJ0R00U
W2011	7030000010	S.JUMPER MCR10EZHZ JPW (000)

S.=Surface mount

[MAIN UNIT]

REF NO.	ORDER NO.	DESCRIPTION	
W2012	7030008240	S.JUMPER	ERJ12YJ0R00U
W2013	7030003860	S.JUMPER	ERJ3GE JPW V
W2014	7030003860	S.JUMPER	ERJ3GE JPW V
W2015	7120000470	JUMPER	ERDS2T0
W2016	7030003860	S.JUMPER	ERJ3GE JPW V
W2017	7030000010	S.JUMPER	MCR10EZHZ JPW (000)
W2018	7030000010	S.JUMPER	MCR10EZHZ JPW (000)
W2019	7030000010	S.JUMPER	MCR10EZHZ JPW (000)
W2020	7030003860	S.JUMPER	ERJ3GE JPW V
W2021	7030003860	S.JUMPER	ERJ3GE JPW V
W2022	7030003860	S.JUMPER	ERJ3GE JPW V
W2023	7030003860	S.JUMPER	ERJ3GE JPW V
W2024	7030003860	S.JUMPER	ERJ3GE JPW V
W2025	7030003860	S.JUMPER	ERJ3GE JPW V
W2026	7030003860	S.JUMPER	ERJ3GE JPW V
W2027	7030003860	S.JUMPER	ERJ3GE JPW V
W2028	7030003860	S.JUMPER	ERJ3GE JPW V
W2029	7030003860	S.JUMPER	ERJ3GE JPW V
W2030	7030003860	S.JUMPER	ERJ3GE JPW V
W2031	7030003860	S.JUMPER	ERJ3GE JPW V
W2032	7030003860	S.JUMPER	ERJ3GE JPW V
W2033	7030000010	S.JUMPER	MCR10EZHZ JPW (000)
W2034	7030003860	S.JUMPER	ERJ3GE JPW V
W2035	7030003860	S.JUMPER	ERJ3GE JPW V
W2036	7030003860	S.JUMPER	ERJ3GE JPW V
W2037	7030008240	S.JUMPER	ERJ12YJ0R00U
EP1	6910012350	S.BEAD	MMZ1608Y 102BT
EP2	6910012350	S.BEAD	MMZ1608Y 102BT
EP2000	6910012350	S.BEAD	MMZ1608Y 102BT
EP2001	6910012350	S.BEAD	MMZ1608Y 102BT
EP2002	6910012350	S.BEAD	MMZ1608Y 102BT
EP2003	6910012350	S.BEAD	MMZ1608Y 102BT
EP2004	6910012350	S.BEAD	MMZ1608Y 102BT
EP2005	6910012350	S.BEAD	MMZ1608Y 102BT
EP2006	6910012350	S.BEAD	MMZ1608Y 102BT
EP2007	6910012350	S.BEAD	MMZ1608Y 102BT
EP2008	6910012350	S.BEAD	MMZ1608Y 102BT
EP2010	6910012350	S.BEAD	MMZ1608Y 102BT
EP2011	6910012350	S.BEAD	MMZ1608Y 102BT
EP2012	6910012350	S.BEAD	MMZ1608Y 102BT
EP2013	6910012350	S.BEAD	MMZ1608Y 102BT
EP2014	6910012350	S.BEAD	MMZ1608Y 102BT
EP2015	6910012350	S.BEAD	MMZ1608Y 102BT
EP2018	0910054984	PCB	B 5766D
EP2019	6910012350	S.BEAD	MMZ1608Y 102BT
EP2020	6910000640	BEAD	FSRH090160RN000B
EP2021	6910000640	BEAD	FSRH090160RN000B
EP2022	6910012350	S.BEAD	MMZ1608Y 102BT
EP2023	6910012350	S.BEAD	MMZ1608Y 102BT
EP2024	6910012350	S.BEAD	MMZ1608Y 102BT

[VCO UNIT]

REF NO.	ORDER NO.	DESCRIPTION	
IC1	1140005990	S.IC	MB15A02PFV1-G-BND-ER
IC2	1130004200	S.IC	TC4S66F (TE85R)
IC3	1110004460	S.IC	μPB1509GV-E1
Q1	1530002560	S.TRANSISTOR	2SC4403-3-TL
Q2	1510000770	S.TRANSISTOR	2SA1586-GR (TE85R)
Q3	1530002690	S.TRANSISTOR	2SC4116-GR (TE85R)
Q4	1590000430	S.TRANSISTOR	DTC144EUA T106
Q5	1590001320	S.TRANSISTOR	DTC143ZUA T106
Q6	1530003580	S.TRANSISTOR	2SC5231C8-TL
Q7	1530003580	S.TRANSISTOR	2SC5231C8-TL
Q8	1530003580	S.TRANSISTOR	2SC5231C8-TL
Q9	1590000440	S.TRANSISTOR	DTA143ZUA T106
Q10	1590000430	S.TRANSISTOR	DTC144EUA T106
D1	1750000770	S.VARICAP	HVC376BTRF
D2	1750000370	S.DIODE	DA221 TL
D3	1720000790	S.VARICAP	HVC321B1TRF
D4	1720000790	S.VARICAP	HVC321B1TRF
D5	1720000790	S.VARICAP	HVC321B1TRF
D6	1790001260	S.DIODE	MA2S077-(TX)
D7	1790001260	S.DIODE	MA2S077-(TX)
D8	1790001260	S.DIODE	MA2S077-(TX)
D9	1790001260	S.DIODE	MA2S077-(TX)
D10	1790001260	S.DIODE	MA2S077-(TX)
D11	1790001260	S.DIODE	MA2S077-(TX)
D12	1790001620	S.DIODE	1SV308 (TPL3)
D13	1790001620	S.DIODE	1SV308 (TPL3)
D14	1790001250	S.DIODE	MA2S111-(TX)
D15	1790001260	S.DIODE	MA2S077-(TX)
D16	1790001260	S.DIODE	MA2S077-(TX)
X1	6050011320	S.XTAL	CR-718 (12.8 MHz)
L1	6200006670	S.COIL	ELJRE 68NG-F
L2	6200002610	S.COIL	NL 252018T-R47J
L3	6200010310	S.COIL	C2012C-27NG
L4	6200010310	S.COIL	C2012C-27NG
L5	6200007610	S.COIL	LL1608-FH39NJ
L6	6200007600	S.COIL	LL1608-FH33NJ
L7	6200006980	S.COIL	ELJRE R10G-F
L8	6200007540	S.COIL	LL1608-FH10NJ
L9	6200007610	S.COIL	LL1608-FH39NJ
L10	6200006990	S.COIL	ELJRE 56NG-F
L11	6200007590	S.COIL	LL1608-FH27NJ
L12	6200003540	S.COIL	MLF1608D R22K-T
L13	6200006670	S.COIL	ELJRE 68NG-F
L14	6200006670	S.COIL	ELJRE 68NG-F
R1	7030003560	S.RESISTOR	ERJ3GEYJ 103 V (10 kΩ)
R2	7030003380	S.RESISTOR	ERJ3GEYJ 331 V (330 Ω)
R3	7030003680	S.RESISTOR	ERJ3GEYJ 104 V (100 kΩ)
R4	7030003440	S.RESISTOR	ERJ3GEYJ 102 V (1 kΩ)
R5	7030003600	S.RESISTOR	ERJ3GEYJ 223 V (22 kΩ)
R6	7030003560	S.RESISTOR	ERJ3GEYJ 103 V (10 kΩ)
R7	7030003360	S.RESISTOR	ERJ3GEYJ 221 V (220 Ω)
R8	7030003600	S.RESISTOR	ERJ3GEYJ 223 V (22 kΩ)
R9	7030003340	S.RESISTOR	ERJ3GEYJ 151 V (150 Ω)
R10	7030003600	S.RESISTOR	ERJ3GEYJ 223 V (22 kΩ)
R11	7030003240	S.RESISTOR	ERJ3GEYJ 220 V (22 Ω)
R12	7030003560	S.RESISTOR	ERJ3GEYJ 103 V (10 kΩ)
R13	7030003590	S.RESISTOR	ERJ3GEYJ 183 V (18 kΩ)
R14	7030003560	S.RESISTOR	ERJ3GEYJ 103 V (10 kΩ)
R15	7030003610	S.RESISTOR	ERJ3GEYJ 273 V (27 kΩ)
R16	7030003560	S.RESISTOR	ERJ3GEYJ 103 V (10 kΩ)
R17	7030003560	S.RESISTOR	ERJ3GEYJ 103 V (10 kΩ)
R18	7030003320	S.RESISTOR	ERJ3GEYJ 101 V (100 Ω)
R19	7030003500	S.RESISTOR	ERJ3GEYJ 332 V (3.3 kΩ)
R20	7030003460	S.RESISTOR	ERJ3GEYJ 152 V (1.5 kΩ)
R21	7030003320	S.RESISTOR	ERJ3GEYJ 101 V (100 Ω)
R22	7030003450	S.RESISTOR	ERJ3GEYJ 122 V (1.2 kΩ)
R23	7030003450	S.RESISTOR	ERJ3GEYJ 122 V (1.2 kΩ)
R24	7030003450	S.RESISTOR	ERJ3GEYJ 122 V (1.2 kΩ)
R25	7030003440	S.RESISTOR	ERJ3GEYJ 102 V (1 kΩ)
R26	7030003600	S.RESISTOR	ERJ3GEYJ 223 V (22 kΩ)
R27	7030003840	S.RESISTOR	ERJ3GEYJ 225 V (2.2 MΩ)
R28	7030003680	S.RESISTOR	ERJ3GEYJ 104 V (100 kΩ)

S.=Surface mount

[VCO UNIT]

REF NO.	ORDER NO.	DESCRIPTION	
R29	7030003640	S.RESISTOR	ERJ3GEYJ 473 V (47 kΩ)
R30	7030003440	S.RESISTOR	ERJ3GEYJ 102 V (1 kΩ)
R31	7030003520	S.RESISTOR	ERJ3GEYJ 472 V (4.7 kΩ)
R32	7030003560	S.RESISTOR	ERJ3GEYJ 103 V (10 kΩ)
R33	7030003210	S.RESISTOR	ERJ3GEYJ 120 V (12 Ω)
R34	7030003280	S.RESISTOR	ERJ3GEYJ 470 V (47 Ω)
R35	7030003560	S.RESISTOR	ERJ3GEYJ 103 V (10 kΩ)
R36	7030003430	S.RESISTOR	ERJ3GEYJ 821 V (820 Ω)
R37	7030003320	S.RESISTOR	ERJ3GEYJ 101 V (100 Ω)
R38	7030003210	S.RESISTOR	ERJ3GEYJ 120 V (12 Ω)
R39	7030003330	S.RESISTOR	ERJ3GEYJ 121 V (120 Ω)
R40	7030003520	S.RESISTOR	ERJ3GEYJ 472 V (4.7 kΩ)
R41	7030003480	S.RESISTOR	ERJ3GEYJ 222 V (2.2 kΩ)
R42	7030003560	S.RESISTOR	ERJ3GEYJ 103 V (10 kΩ)
R43	7030003470	S.RESISTOR	ERJ3GEYJ 182 V (1.8 kΩ)
R44	7030003440	S.RESISTOR	ERJ3GEYJ 102 V (1 kΩ)
R45	7030003320	S.RESISTOR	ERJ3GEYJ 101 V (100 Ω)
R46	7030003560	S.RESISTOR	ERJ3GEYJ 103 V (10 kΩ)
R47	7030003470	S.RESISTOR	ERJ3GEYJ 182 V (1.8 kΩ)
R48	7030003520	S.RESISTOR	ERJ3GEYJ 472 V (4.7 kΩ)
R49	7030003480	S.RESISTOR	ERJ3GEYJ 222 V (2.2 kΩ)
R50	7030003460	S.RESISTOR	ERJ3GEYJ 152 V (1.5 kΩ)
R51	7030004050	S.RESISTOR	ERJ3GEYJ 1R0 V (1 Ω)
R52	7030003520	S.RESISTOR	ERJ3GEYJ 472 V (4.7 kΩ)
R53	7030003330	S.RESISTOR	ERJ3GEYJ 121 V (120 Ω)
R54	7030003480	S.RESISTOR	ERJ3GEYJ 222 V (2.2 kΩ)
R55	7030003560	S.RESISTOR	ERJ3GEYJ 103 V (10 kΩ)
R56	7030003440	S.RESISTOR	ERJ3GEYJ 102 V (1 kΩ)
R57	7030003260	S.RESISTOR	ERJ3GEYJ 330 V (33 Ω)
R58	7030003250	S.RESISTOR	ERJ3GEYJ 270 V (27 Ω)
R59	7030003250	S.RESISTOR	ERJ3GEYJ 270 V (27 Ω)
R60	7030003440	S.RESISTOR	ERJ3GEYJ 102 V (1 kΩ)
R61	7030003440	S.RESISTOR	ERJ3GEYJ 102 V (1 kΩ)
R62	7030003340	S.RESISTOR	ERJ3GEYJ 151 V (150 Ω)
R63	7030003840	S.RESISTOR	ERJ3GEYJ 225 V (2.2 MΩ)
C1	4030007090	S.CERAMIC	C1608 CH 1H 470J-T
C2	4030006860	S.CERAMIC	C1608 JB 1H 102K-T
C3	4030006860	S.CERAMIC	C1608 JB 1H 102K-T
C4	4030007090	S.CERAMIC	C1608 CH 1H 470J-T
C5	4030006860	S.CERAMIC	C1608 JB 1H 102K-T
C6	4030006860	S.CERAMIC	C1608 JB 1H 102K-T
C7	4030006860	S.CERAMIC	C1608 JB 1H 102K-T
C8	4030007090	S.CERAMIC	C1608 CH 1H 470J-T
C9	4030007090	S.CERAMIC	C1608 CH 1H 470J-T
C10	4030006860	S.CERAMIC	C1608 JB 1H 102K-T
C11	4030006860	S.CERAMIC	C1608 JB 1H 102K-T
C12	4030006860	S.CERAMIC	C1608 JB 1H 102K-T
C13	4030006900	S.CERAMIC	C1608 JB 1H 103K-T
C14	4030006920	S.CERAMIC	C1608 CH 1H 010C-T
C15	4030006860	S.CERAMIC	C1608 JB 1H 102K-T
C16	4030007100	S.CERAMIC	C1608 CH 1H 560J-T
C17	4030006950	S.CERAMIC	C1608 CH 1H 040C-T
C18	4030017810	S.CERAMIC	C1608 CH 1H 102J-T
C19	4030007060	S.CERAMIC	C1608 CH 1H 270J-T
C20	4030008630	S.CERAMIC	C1608 JF 1H 104Z-T
C21	4030007010	S.CERAMIC	C1608 CH 1H 100D-T
C22	4030007010	S.CERAMIC	C1608 CH 1H 100D-T
C23	4030006850	S.CERAMIC	C1608 JB 1H 471K-T
C24	4030008630	S.CERAMIC	C1608 JF 1H 104Z-T
C25	4030008920	S.CERAMIC	C1608 JB 1H 473K-T
C26	4550000550	S.TANTALUM	TESVA 1V 224M1-8L
C27	4030006860	S.CERAMIC	C1608 JB 1H 102K-T
C28	4550002980	S.TANTALUM	TEMSVA 1C 225M-8L
C29	4550000530	S.TANTALUM	TESVA 1V 104M1-8L
C30	4030011600	S.CERAMIC	C1608 JB 1E 104K-T
C31	4030006860	S.CERAMIC	C1608 JB 1H 102K-T
C32	4030006860	S.CERAMIC	C1608 JB 1H 102K-T
C33	4030006860	S.CERAMIC	C1608 JB 1H 102K-T
C34	4030009570	S.CERAMIC	C1608 CH 1H 0R3B-T
C35	4030006860	S.CERAMIC	C1608 JB 1H 102K-T
C36	4030006860	S.CERAMIC	C1608 JB 1H 102K-T
C37	4030007020	S.CERAMIC	C1608 CH 1H 120J-T
C38	4030007050	S.CERAMIC	C1608 CH 1H 220J-T
C39	4030007040	S.CERAMIC	C1608 CH 1H 180J-T
C40	4030006920	S.CERAMIC	C1608 CH 1H 010C-T
C41	4030006860	S.CERAMIC	C1608 JB 1H 102K-T
C42	4030006860	S.CERAMIC	C1608 JB 1H 102K-T
C43	4030006860	S.CERAMIC	C1608 JB 1H 102K-T
C44	4030006860	S.CERAMIC	C1608 JB 1H 102K-T
C45	4030006970	S.CERAMIC	C1608 CH 1H 060D-T

[VCO UNIT]

REF NO.	ORDER NO.	DESCRIPTION	
C46	4030007020	S.CERAMIC	C1608 CH 1H 120J-T
C47	4030007030	S.CERAMIC	C1608 CH 1H 150J-T
C48	4030007040	S.CERAMIC	C1608 CH 1H 180J-T
C49	4030006990	S.CERAMIC	C1608 CH 1H 080D-T
C50	4030006860	S.CERAMIC	C1608 JB 1H 102K-T
C51	4030006920	S.CERAMIC	C1608 CH 1H 010C-T
C52	4030006970	S.CERAMIC	C1608 CH 1H 060D-T
C53	4030007060	S.CERAMIC	C1608 CH 1H 270J-T
C54	4030006970	S.CERAMIC	C1608 CH 1H 060D-T
C55	4030007050	S.CERAMIC	C1608 CH 1H 220J-T
C56	4030006860	S.CERAMIC	C1608 JB 1H 102K-T
C57	4030006970	S.CERAMIC	C1608 CH 1H 060D-T
C58	4030006980	S.CERAMIC	C1608 CH 1H 070D-T
C59	4030007040	S.CERAMIC	C1608 CH 1H 180J-T
C60	4030006910	S.CERAMIC	C1608 CH 1H 0R5C-T
C61	4030006860	S.CERAMIC	C1608 JB 1H 102K-T
C62	4030006950	S.CERAMIC	C1608 CH 1H 040C-T
C63	4030007030	S.CERAMIC	C1608 CH 1H 150J-T
C64	4030006860	S.CERAMIC	C1608 JB 1H 102K-T
C65	4030006980	S.CERAMIC	C1608 CH 1H 070D-T
C66	4030006860	S.CERAMIC	C1608 JB 1H 102K-T
C67	4030007040	S.CERAMIC	C1608 CH 1H 180J-T
C68	4030007090	S.CERAMIC	C1608 CH 1H 470J-T
C69	4030006990	S.CERAMIC	C1608 CH 1H 080D-T
C70	4030006860	S.CERAMIC	C1608 JB 1H 102K-T
C71	4030006920	S.CERAMIC	C1608 CH 1H 010C-T
C72	4030006860	S.CERAMIC	C1608 JB 1H 102K-T
C73	4030006860	S.CERAMIC	C1608 JB 1H 102K-T
C74	4030006860	S.CERAMIC	C1608 JB 1H 102K-T
C75	4030006860	S.CERAMIC	C1608 JB 1H 102K-T
C76	4030007090	S.CERAMIC	C1608 CH 1H 470J-T
C77	4030006850	S.CERAMIC	C1608 JB 1H 471K-T
C78	4030011600	S.CERAMIC	C1608 JB 1E 104K-T
C79	4030007050	S.CERAMIC	C1608 CH 1H 220J-T
C80	4030006940	S.CERAMIC	C1608 CH 1H 030C-T
C81	4030006860	S.CERAMIC	C1608 JB 1H 102K-T
C82	4030006860	S.CERAMIC	C1608 JB 1H 102K-T
C83	4030006860	S.CERAMIC	C1608 JB 1H 102K-T
C84	4030006860	S.CERAMIC	C1608 JB 1H 102K-T
C85	4030006860	S.CERAMIC	C1608 JB 1H 102K-T
C86	4030006860	S.CERAMIC	C1608 JB 1H 102K-T
C87	4030007060	S.CERAMIC	C1608 CH 1H 270J-T
C88	4030007100	S.CERAMIC	C1608 CH 1H 560J-T
C89	4030007060	S.CERAMIC	C1608 CH 1H 270J-T
J1	6510023410	CONNECTOR	IMSA-9210B-1-06Z172-T
J2	6510023400	CONNECTOR	IMSA-9210B-1-03Z172-T
J3	6510023400	CONNECTOR	IMSA-9210B-1-03Z172-T
J4	6510023400	CONNECTOR	IMSA-9210B-1-03Z172-T
J5	6510023410	CONNECTOR	IMSA-9210B-1-06Z172-T
W1	7030003860	S.JUMPER	ERJ3GE JPW V
W2	7030003860	S.JUMPER	ERJ3GE JPW V
W3	7030003860	S.JUMPER	ERJ3GE JPW V
W4	7030003860	S.JUMPER	ERJ3GE JPW V
EP1	0910055402	PCB	B 5844B

S.=Surface mount

SECTION 6 MECHANICAL PARTS AND DISASSEMBLY

[CHASSIS PARTS]

REF. NO.	ORDER NO.	DESCRIPTION	QTY.
J1	6510004880	Connector MR-DS-E 01	1
SP1	2510001160	Speaker 057P0802	1
MF1	2710000730	Fan AD0412HB-G70 (TS)	1
MP1	8010018850	2493 chassis	1
MP2	8110007720	2493 cover	1
MP3	8930057750	2493 SP holder	1
MP4	8110005750	1729 fan cover	1
MP5	8930044761	2055 SP net-1	1
MP7	8810009610	Screw FH M2.6 × 6 ZK	8
MP8	8810008660	Screw PH BT M3 × 8 NI-ZU	12
MP9	8810008660	Screw PH BT M3 × 8 NI-ZU	2
MP10	8810008490	Setscrew H M2.6 × 8 NI	2
MP11	8810009110	Screw PH M2.6 × 16 ZK	4
MP12	8930054560	Thermally sheet (T)	1
MP13	8930054560	Thermally sheet (T)	1
MP15	8930057800	2493 clip	1
MP16	8810008660	Screw BT M3 × 8 NI-ZU	2
MP17	8810009130	Screw BT M3 × 12 NI-ZU	4
MP18	8930058940	2493 spring	1
MP19	8930049780	Sponge (GG)	1
WS1	8600036880	SP cable	1

[CONTROL UNIT]

REF. NO.	ORDER NO.	DESCRIPTION	QTY.
J1	6510023110	Connector 3008L-8P8C	1
J2	6510023170	Connector 3008L-6P6C	1
R1	7210002920	Variable resistor EVU-F2AF20B55	1
R3	7210002920	Variable resistor EVU-F2AF20B55	1
R5	7210002920	Variable resistor EVU-F2AF20B55	1
R7	7210002920	Variable resistor EVU-F2AF20B55	1
DS19	5030002210	LCD L1-0500TAM	1
S1	2250000460	Encoder EVQ-VENF0224B	1
S2	2250000460	Encoder EVQ-VENF0224B	1
EP15	8930057510	LCD contact SRCN-2493-SP-N-W	1
MP1	8210018920	2493 front panel (A)	1
MP2	8210018550	2493 rear panel	1
MP3	8210018560	2493 reflector	1
MP4	8610011160	Knob N289	2
MP5	8610011170	Knob N290	4
MP6	8930056990	2493 3-key	1
MP7	8930057010	2493 L-key	1
MP8	8930057000	2493 R-key	1
MP9	8930057740	2493 LCD filter	1
MP10	8930057080	2493 LCD plate	1
MP11	8810009220	Screw B0 M2 × 8 ZK	4
MP13	8930059030	Copper sheet (O)	1

[VCO UNIT]

REF. NO.	ORDER NO.	DESCRIPTION	QTY.
MP1	8510013740	2372 VCO case	1
MP2	8510013750	2372 VCO cover	1
MP3	8510014800	2493 VCO case	1
MP4	8510014810	2493 VCO cover	1

[MAIN UNIT]

REF. NO.	ORDER NO.	DESCRIPTION	QTY.
J2001	6510023110	Connector 3008L-8P8C	1
J2003	6510023160	Connector DN-508B-6	1
J2004	6450002220	Connector PJ-0008P-5	1
J2005	6450001440	Connector HSJ1403-01-010	1
J2006	6510023170	Connector 3008L-6P6C	1
W2	8900010980	Cable OPC-1131	1
MP1	8410002380	2399 heatsink	1
MP2	8510014760	2493 PLL case	1
MP3	8510014750	2493 PLL cover	1
MP4	8510014490	2493 shield plate	1
MP5	8930058180	2493 ANT plate	1
MP6	8510015040	2493 V-LPF case assembly	1
MP8	8510014990	2493 U-LPF case	1
MP9	8510015030	2469 PA shield plate	1
MP10	8930059040	Insulate sheet HK	1
MP11	8510015000	2493 A-shield plate	1
MP12	8510015050	2493 TR cover assembly	1
MP14	8930058500	Insulate sheet HB	4

[ACCESSORIES]

REF. NO.	ORDER NO.	DESCRIPTION	QTY.
F1	5210000080	Fuse FGB 20A (FGB0 125V)	1
MC1	0880000980	Microphone HM-133	1
W1	8900010990	Cable OPC-1132	1
MP1	8010016381	1542 mobil bracket (B)-1	1
MP3	8820000530	Flange bolt M4 × 8 NI	4
MP4	8810000950	Screw PH A M5 × 16	4
MP5	8850000390	Spring washer M5	4
MP6	8850000150	Flat washer M5 NI BS	4
MP7	8830000120	Nut M5	4
MP8	8810000470	Screw PH M5 × 12 (+-)	4
MP10	0880001220	Bracket MB-85	1
MP11	8930007300	Mic hanger	1

Screw abbreviations BT: Self-tapping PH: Pan head
 ZK: Black FT: Flat head
 NI: Nickel NI-ZU: Nickel-Zinc

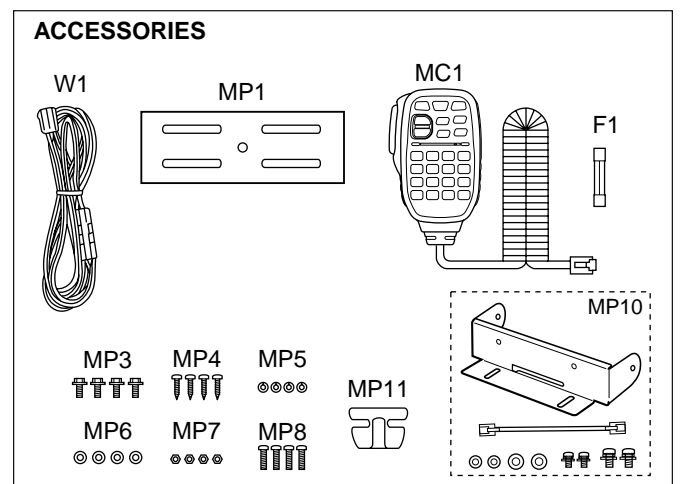

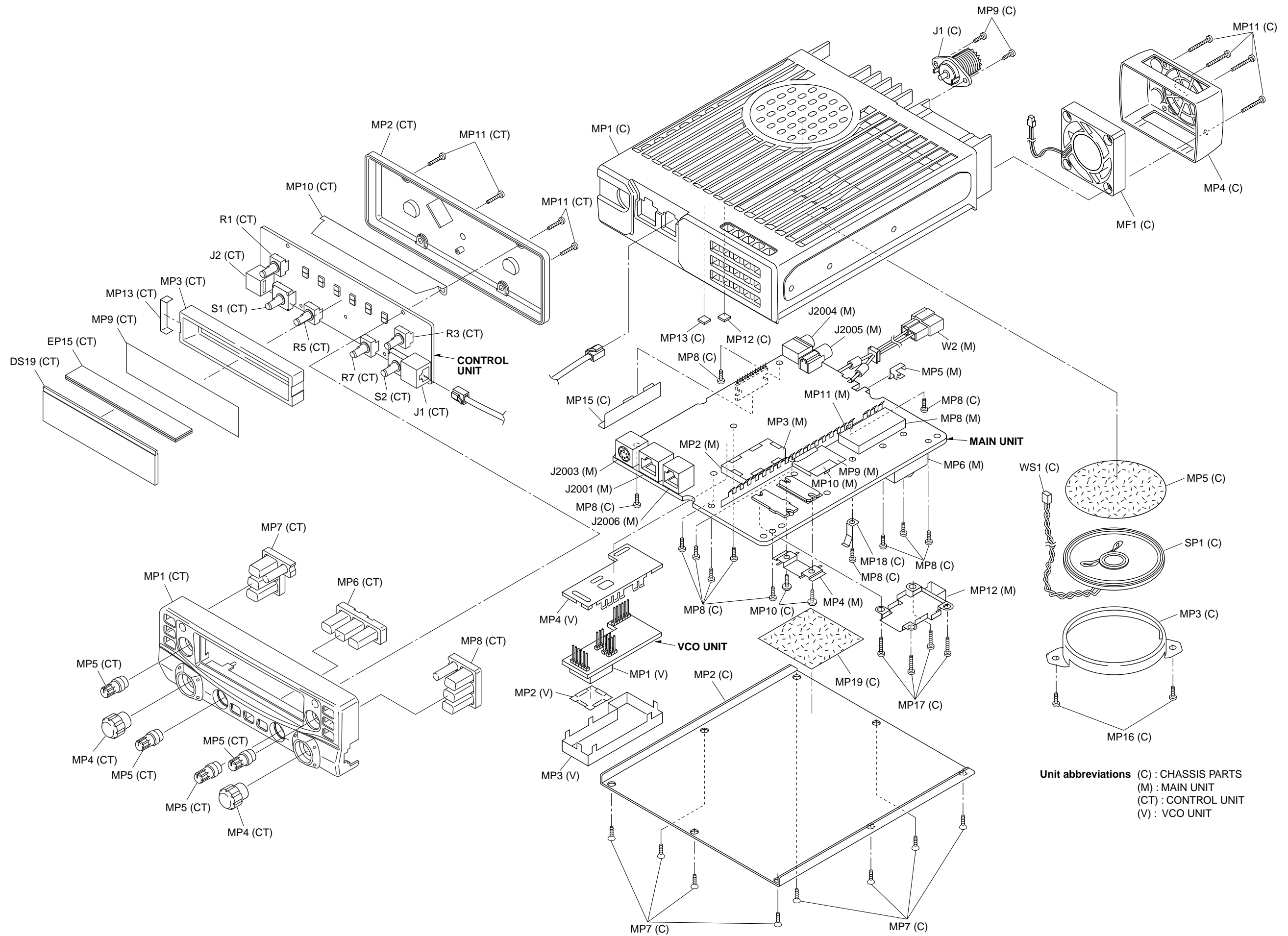



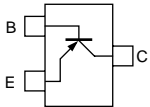
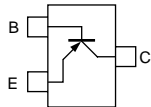
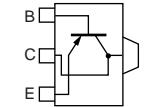
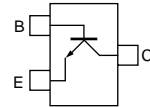
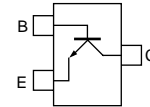
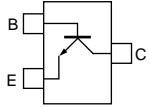
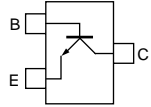
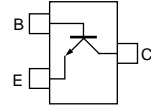
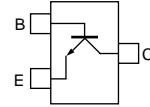
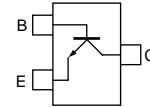
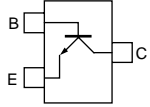
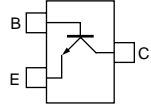
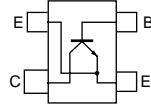
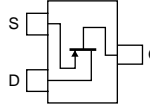
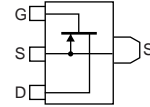
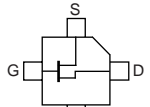
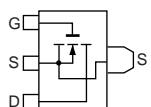
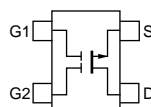
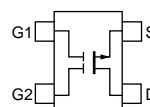
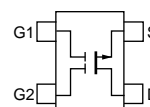
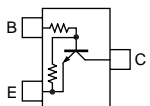
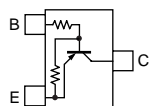
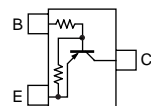
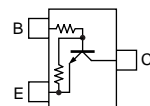
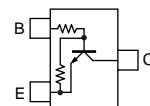
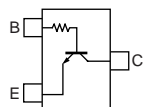
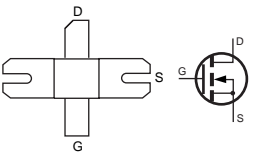
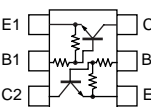
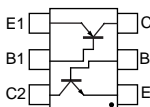
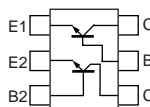

Unit abbreviations (C) : CHASSIS PARTS
(M) : MAIN UNIT
(CT) : CONTROL UNIT
(V) : VCO UNIT

SECTION 7 SEMI-CONDUCTOR INFORMATION

• TRANSISTORS AND FET'S

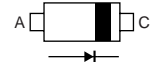
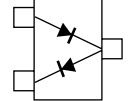
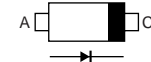
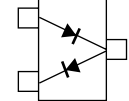
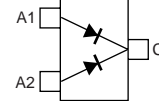
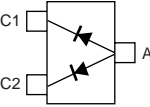
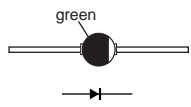
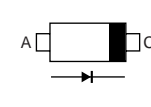
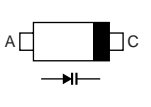
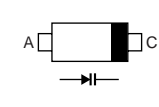
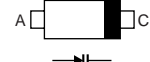
2SA1586 GR (Symbol: SG) 	2SA1588 GR (Symbol: ZG) 	2SB1132 T100 R (Symbol: BAR) 	2SC4116 BL (Symbol: LL) 	2SC4116 GR (Symbol: LG) 
2SC4213 B (Symbol: AB) 	2SC4215 Y (Symbol: QY) 	2SC4226 T1 R25 (Symbol: R25) 	2SC4403 3 TL (Symbol: LY3) 	2SC4406 (Symbol: JT) 
2SC5006 T1 (Symbol: 24) 	2SC5231 C8 (Symbol: C8) 	2SC5624 (Symbol: VH-) 	2SJ144 GR (Symbol: VG) 	2SK2854 (Symbol: UP) 
2SK3075 (Symbol: UB F) 	2SK3475 (Symbol: WB) 	3SK272 (Symbol: K) 	3SK274 (Symbol: UN) 	3SK320 (Symbol: U7) 
DTA114YUA (Symbol: 54) 	DTA143ZUA T106 (Symbol: 113) 	DTA144EUA T106 (Symbol: 16) 	DTC143ZUA (Symbol: E23) 	DTC144EUA T106 (Symbol: 26_) 
DTC144TU T106 (Symbol: 06) 	RD70HVF (Symbol: RD70HVF1) 	XP4213 (Symbol: 8S) 	XP4601 (Symbol: 5C) 	XP6501 AB (Symbol: 5N) 

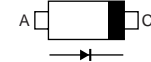
• DIODES

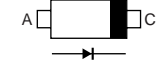
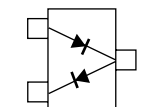
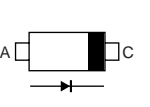
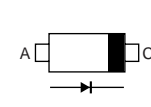
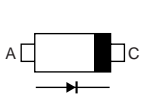
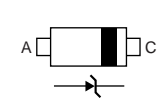
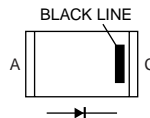
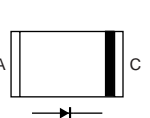
1SS355 (Symbol: A) 	1SV172 (Symbol: BE) 	1SV308 (Symbol: TX) 	DA221 TL (Symbol: K) 	DAN222TL (Symbol: N) 
DAP222 TL (Symbol: P) 	DSA3A1 (Color: Green) 	HVC321B (Symbol: V8) 	HVC350B (Symbol: B0) 	HVC362 (Symbol: V2) 
HVC375B (Symbol: B8) 	HVC376B (Symbol: B9) 	MA2S077 (Symbol: S) 	MA2S111 (Symbol: A) 	MA2S728 (Symbol: B) 
MA742 (Symbol: M1U) 	MA8047 M (Symbol: 4-7) 	MA8062 L (Symbol: 6_2) 	MA8091 M (Symbol: 9-1) 	RD20E B2 (Symbol: 20 B2) 
UM9401F (Symbol: none) 	UM9957F/TR 			

SECTION 8 BOARD LAYOUTS

8-1 CONTROL UNIT • TOP VIEW

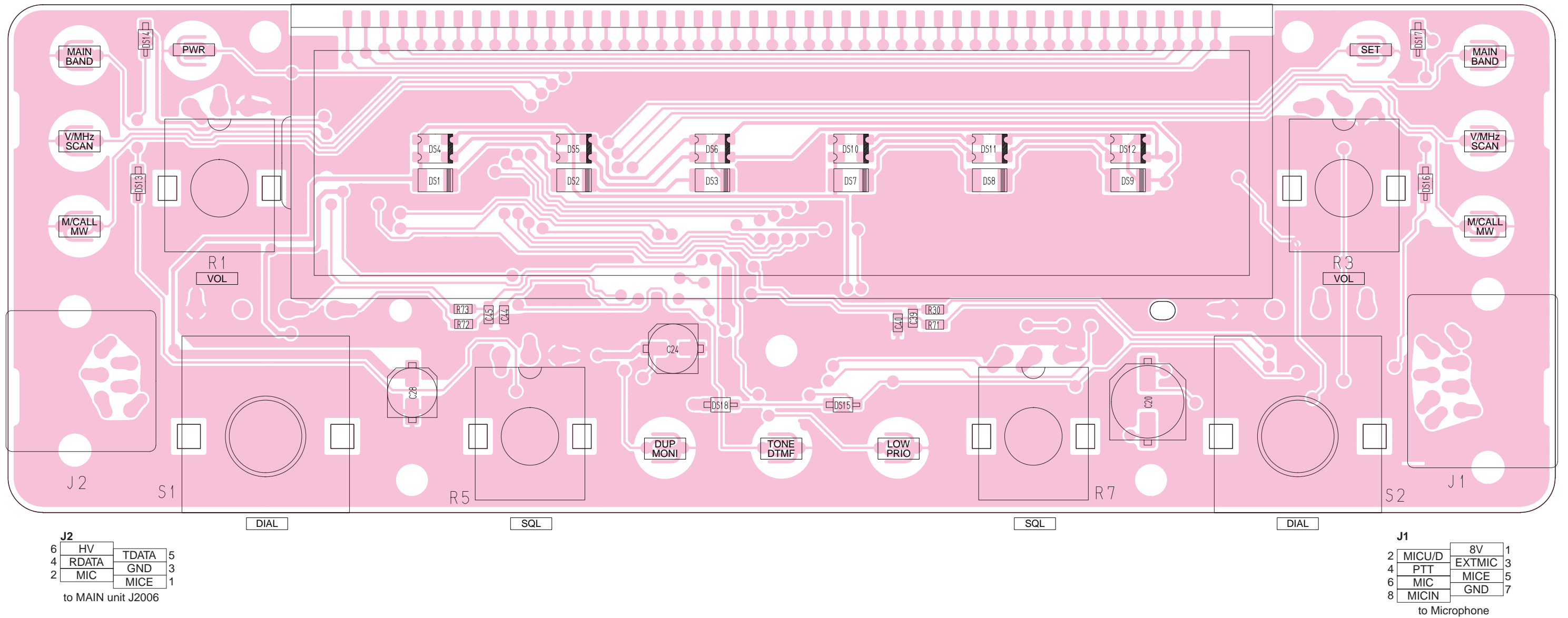

• BOTTOM VIEW (CONTROL UNIT)

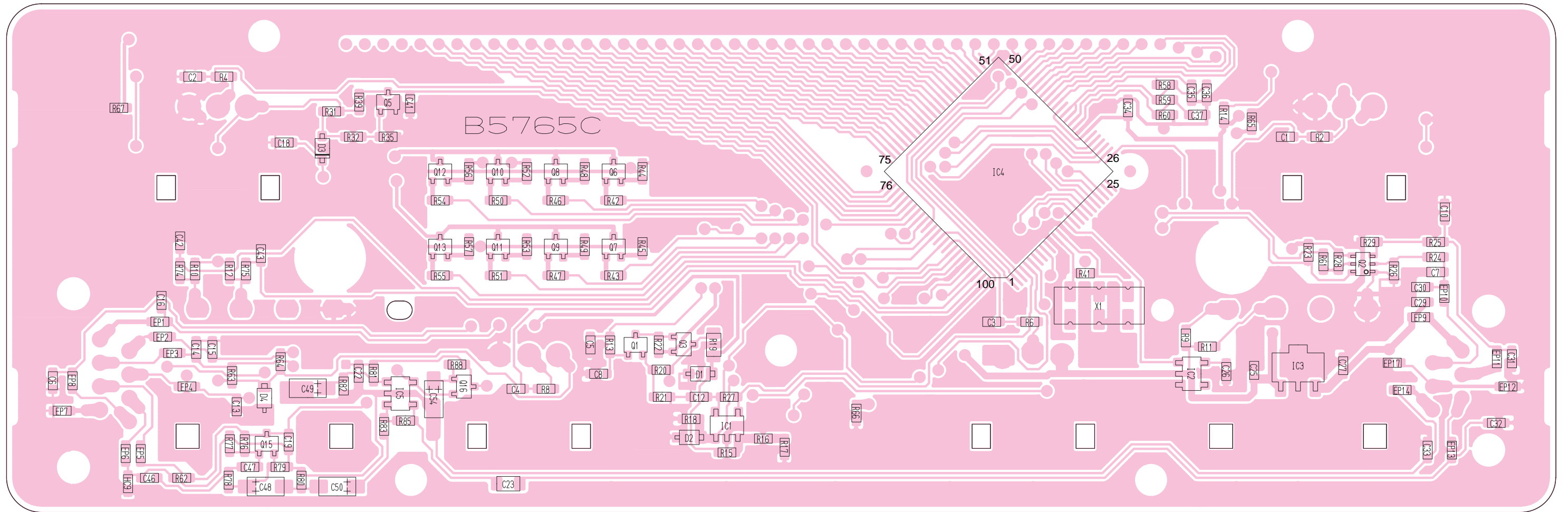

8-2 MAIN UNIT
• TOP VIEW

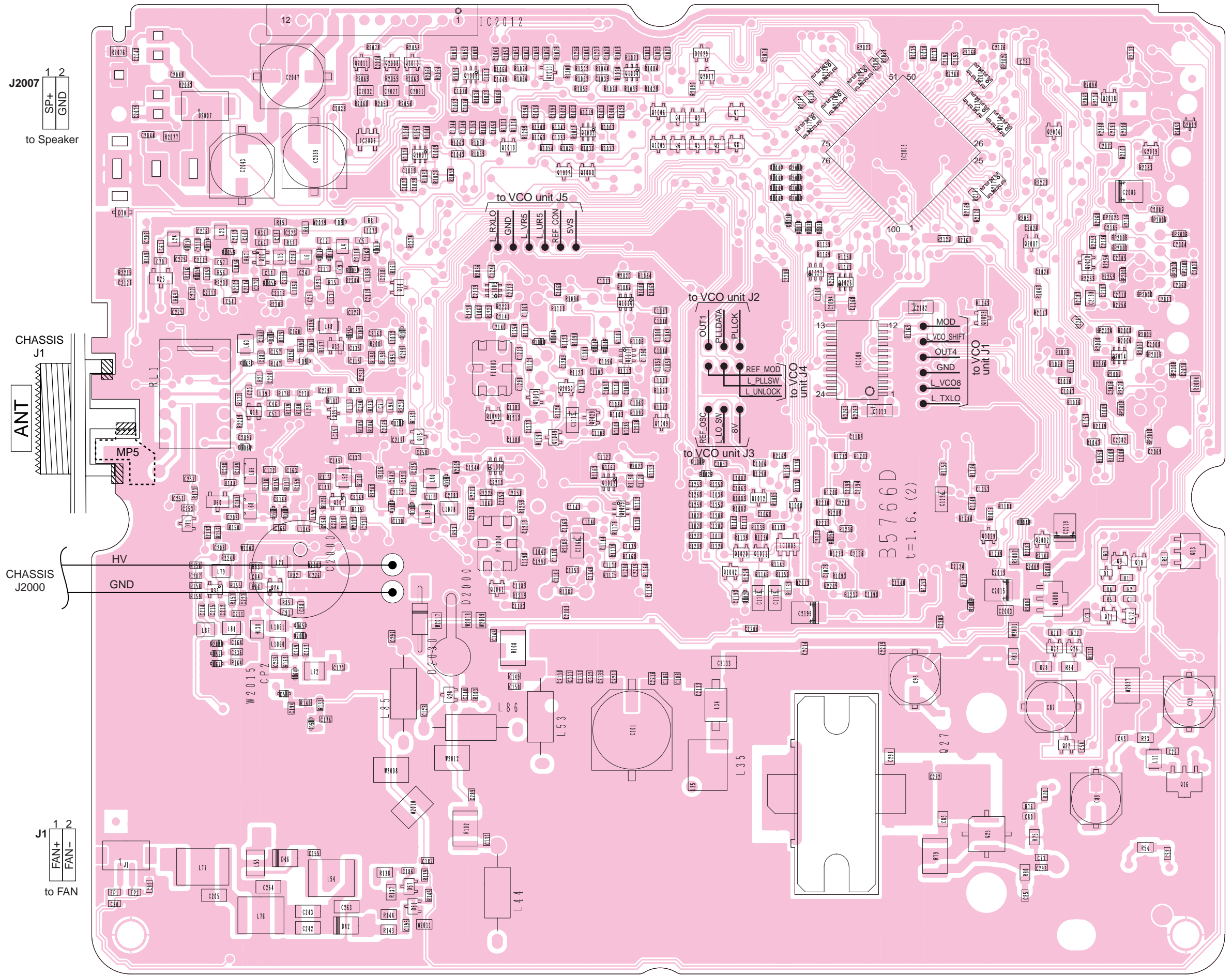

• BOTTOM VIEW (MAIN UNIT)

J2003

4	DATAOUT	PSQL	6
2	GND		
1	DATAIN		
3	PTTP	AFOUT	5

to external equipment

J2001

7	GND	MICIN	8
	MICE	MIC	
	EXTMIC	PTT	
1	8V	MICU/D	2

to Microphone

J2006

6	CTHV	TXDATA	5
	RDATA	GND	
2	MIC	MICE	1

to CONTROL unit J2

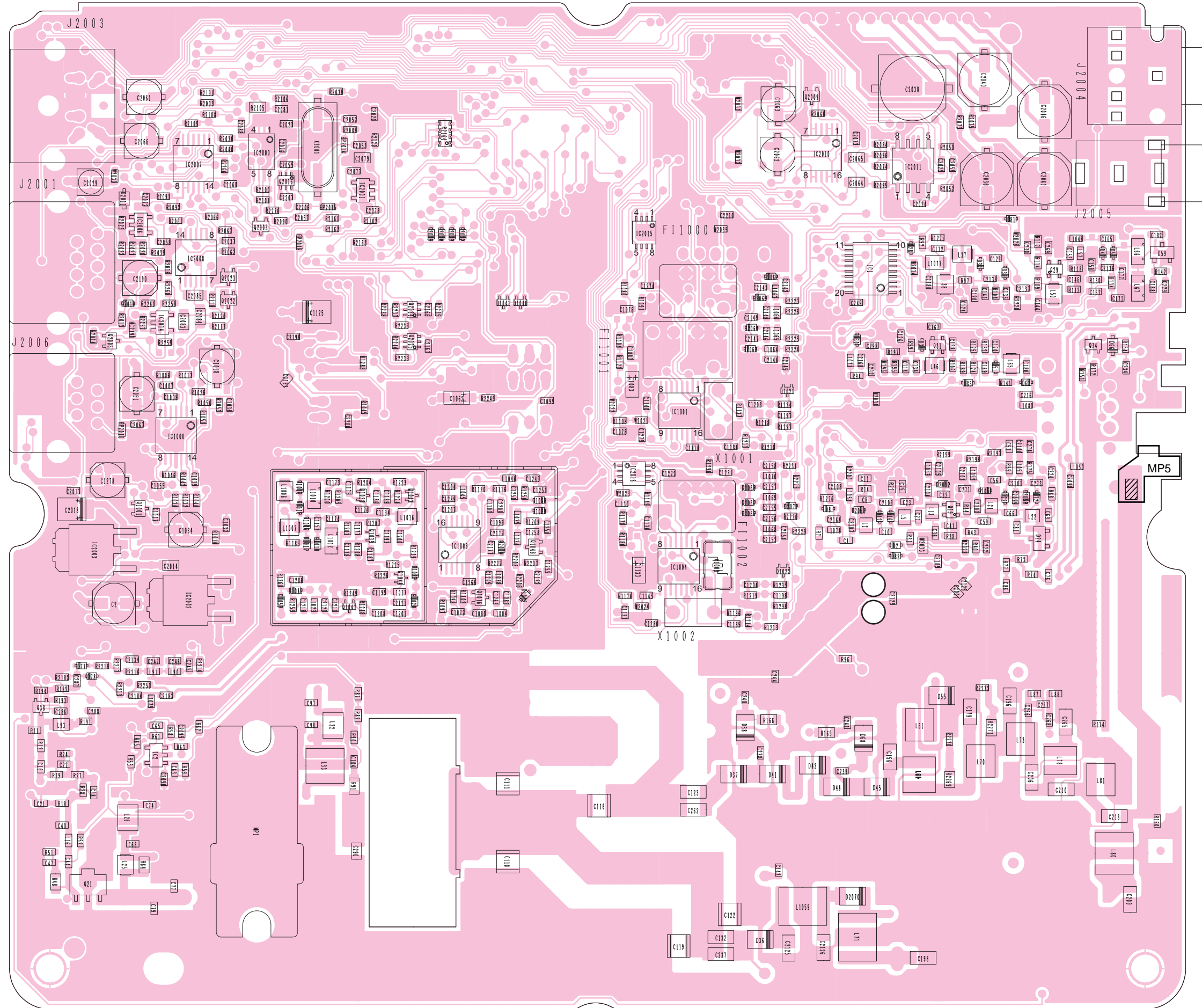

8-3 VCO UNIT
• TOP VIEW

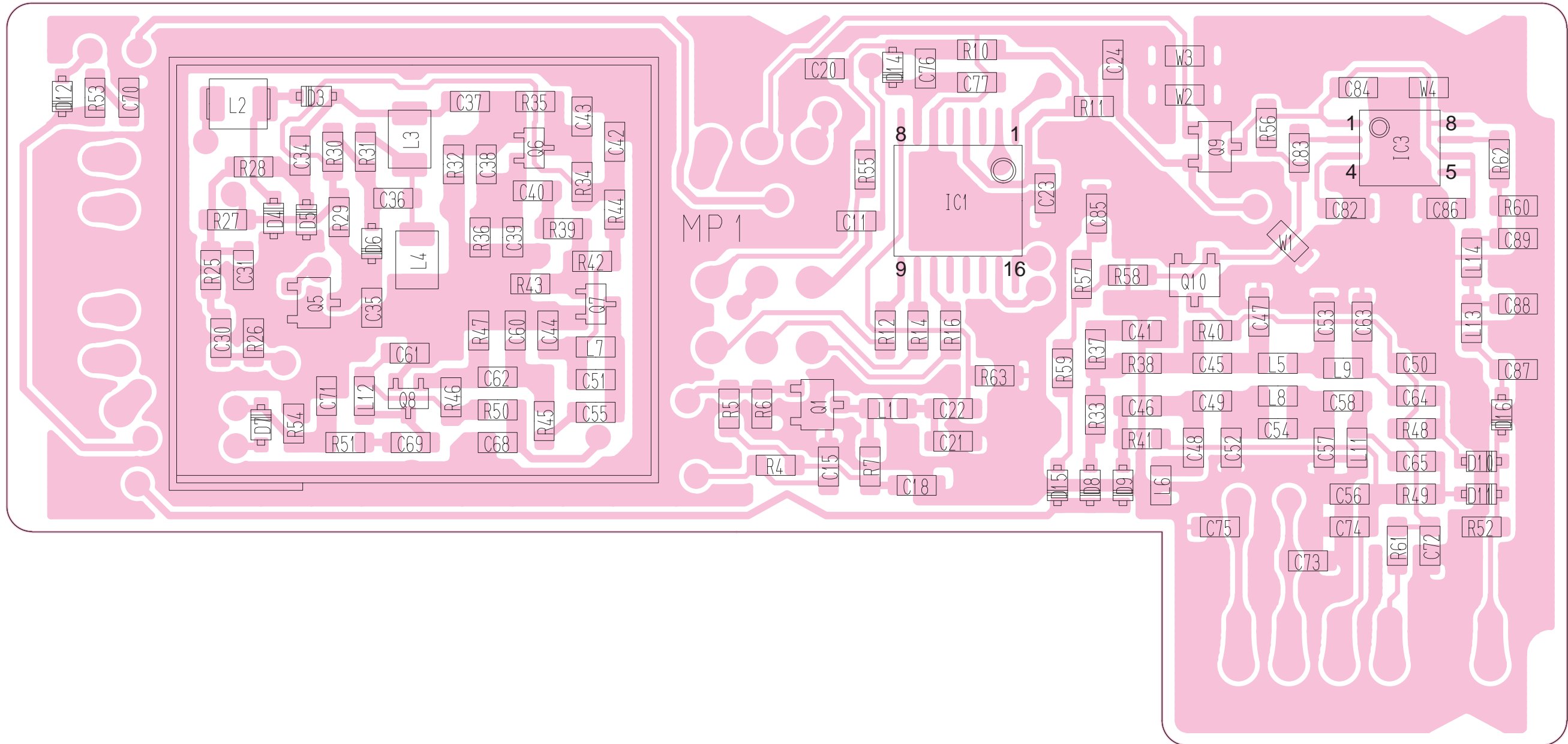

• BOTTOM VIEW (VCO UNIT)

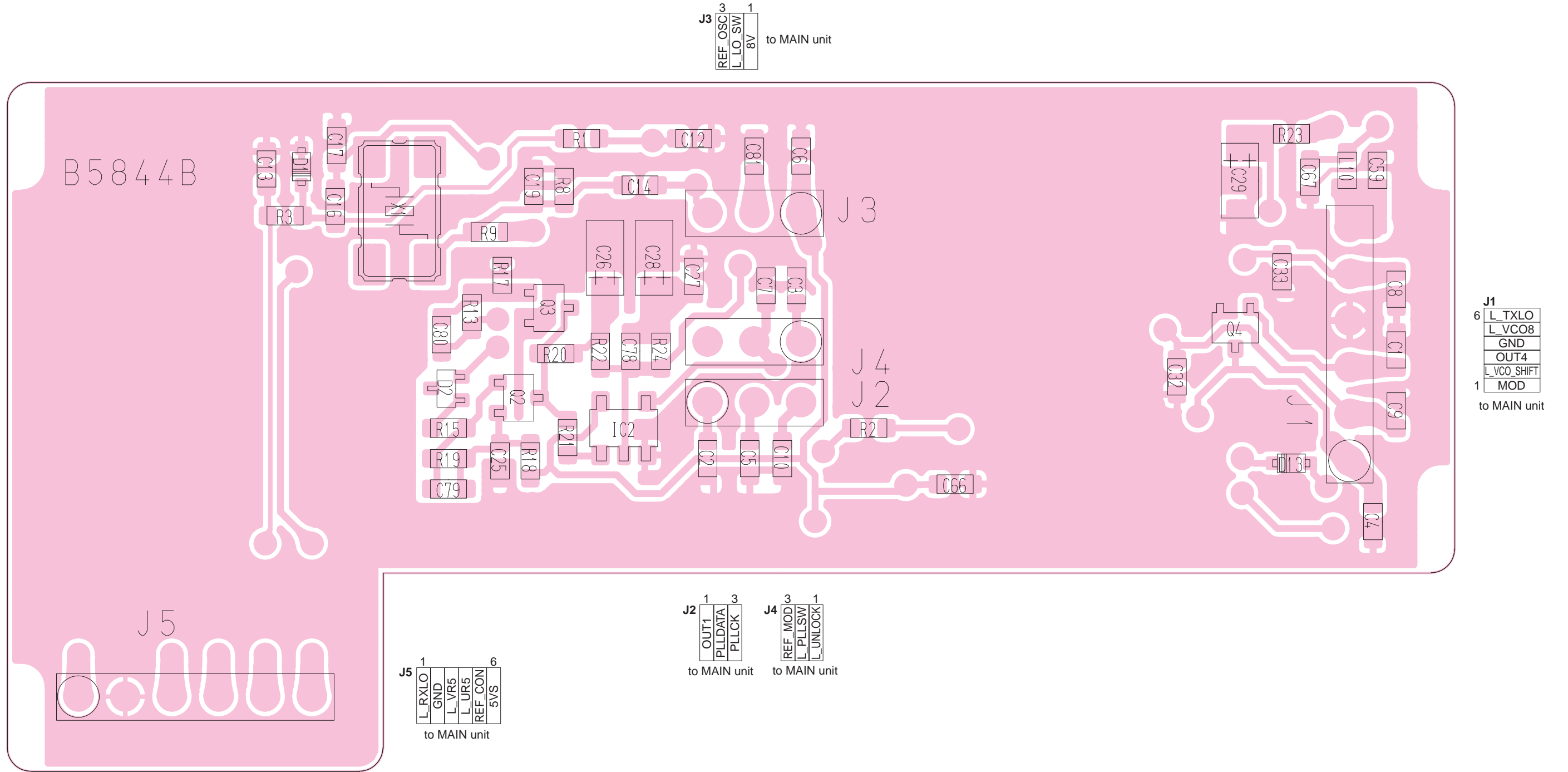

SECTION 9 BLOCK DIAGRAM

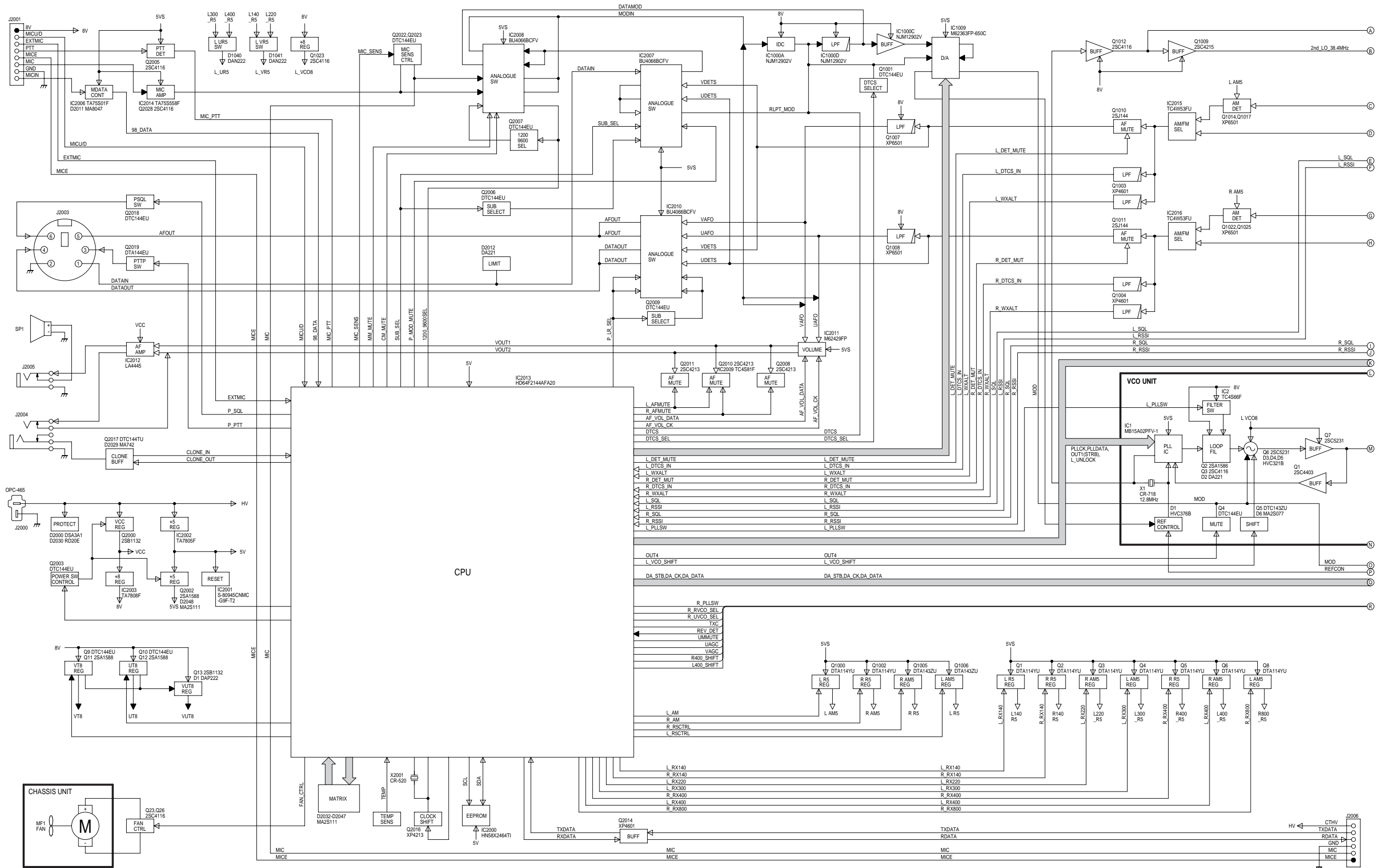

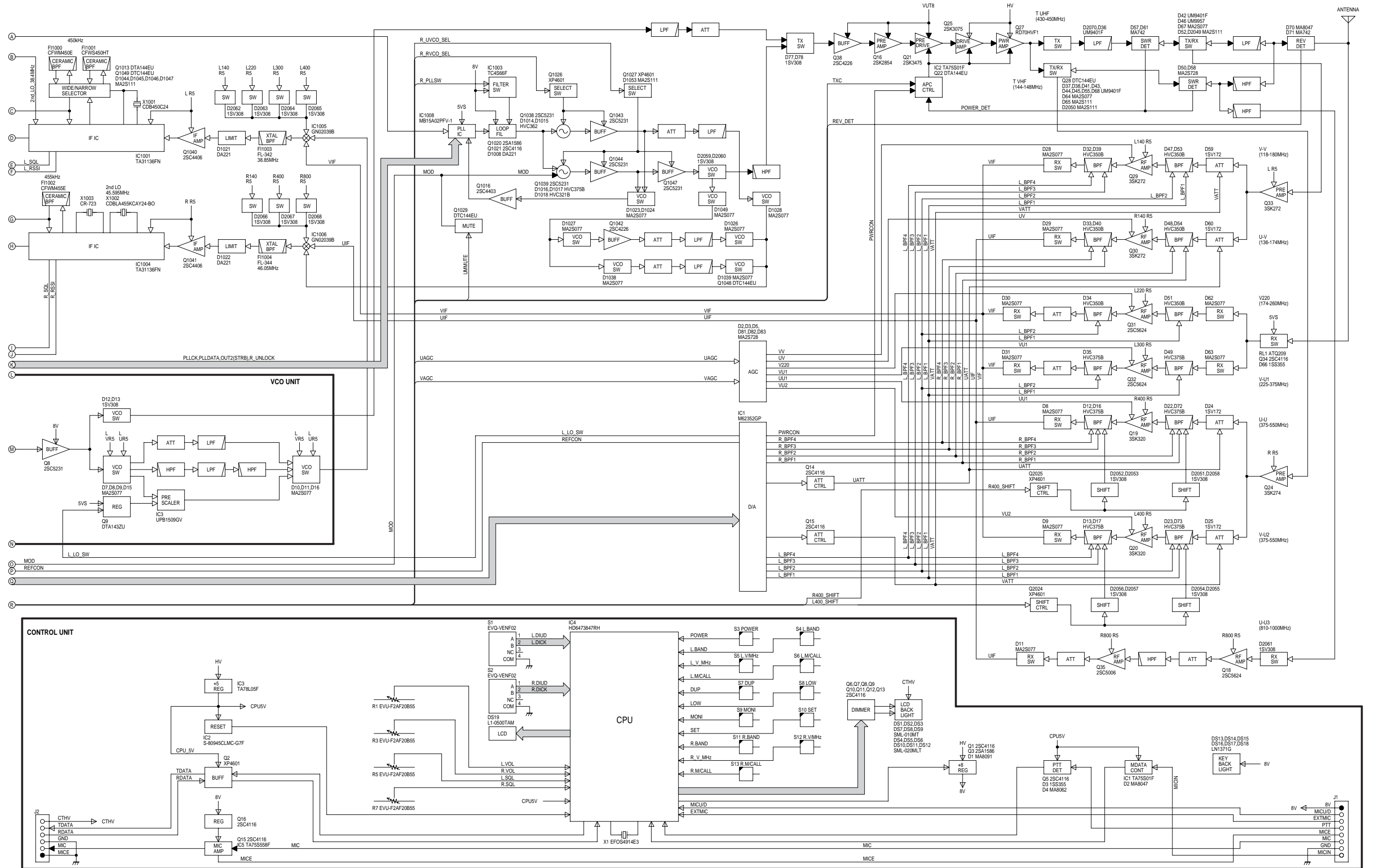

SECTION 10 VOLTAGE DIAGRAMS

10-1 CONTROL UNIT

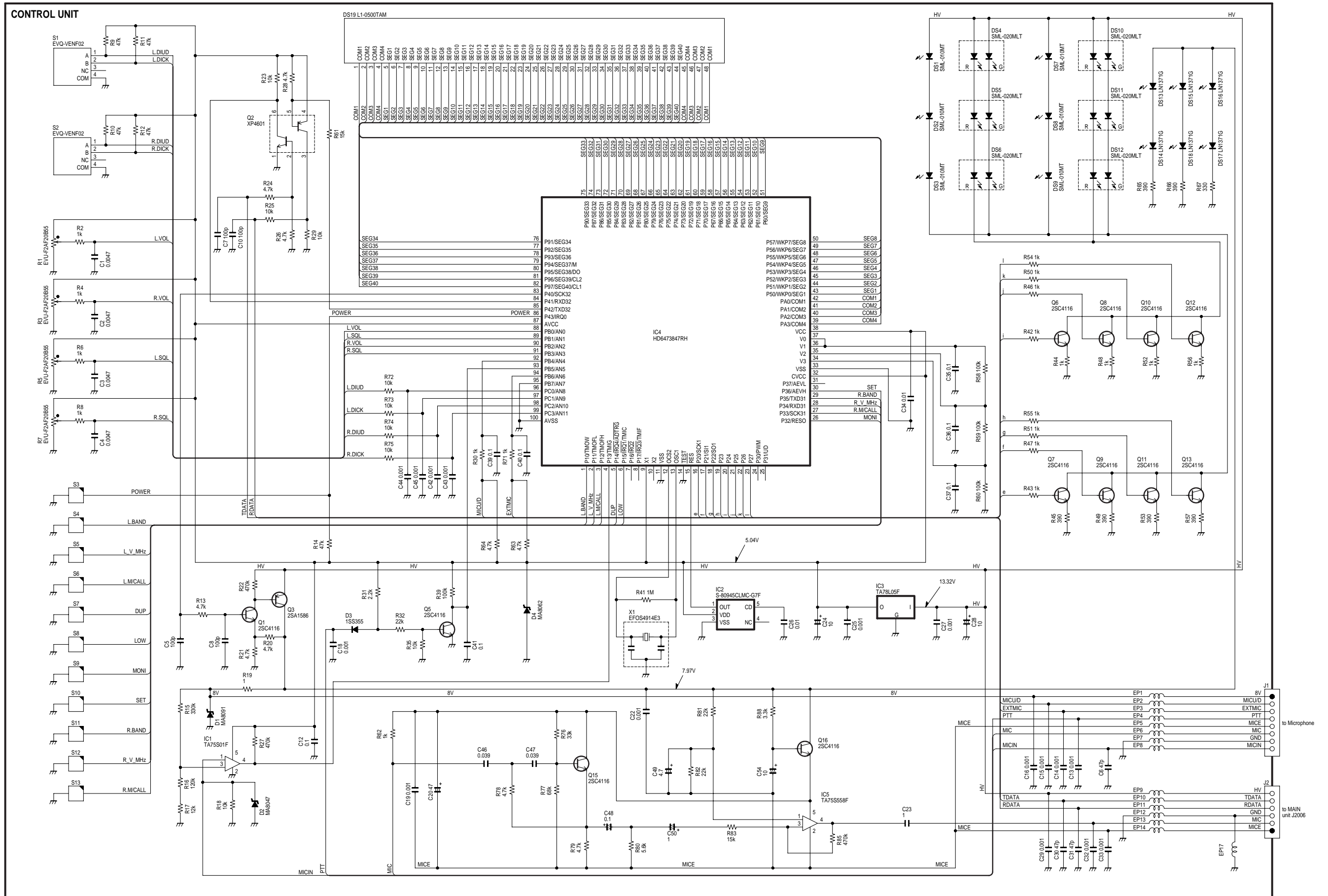

10-2 MAIN AND VCO UNITS

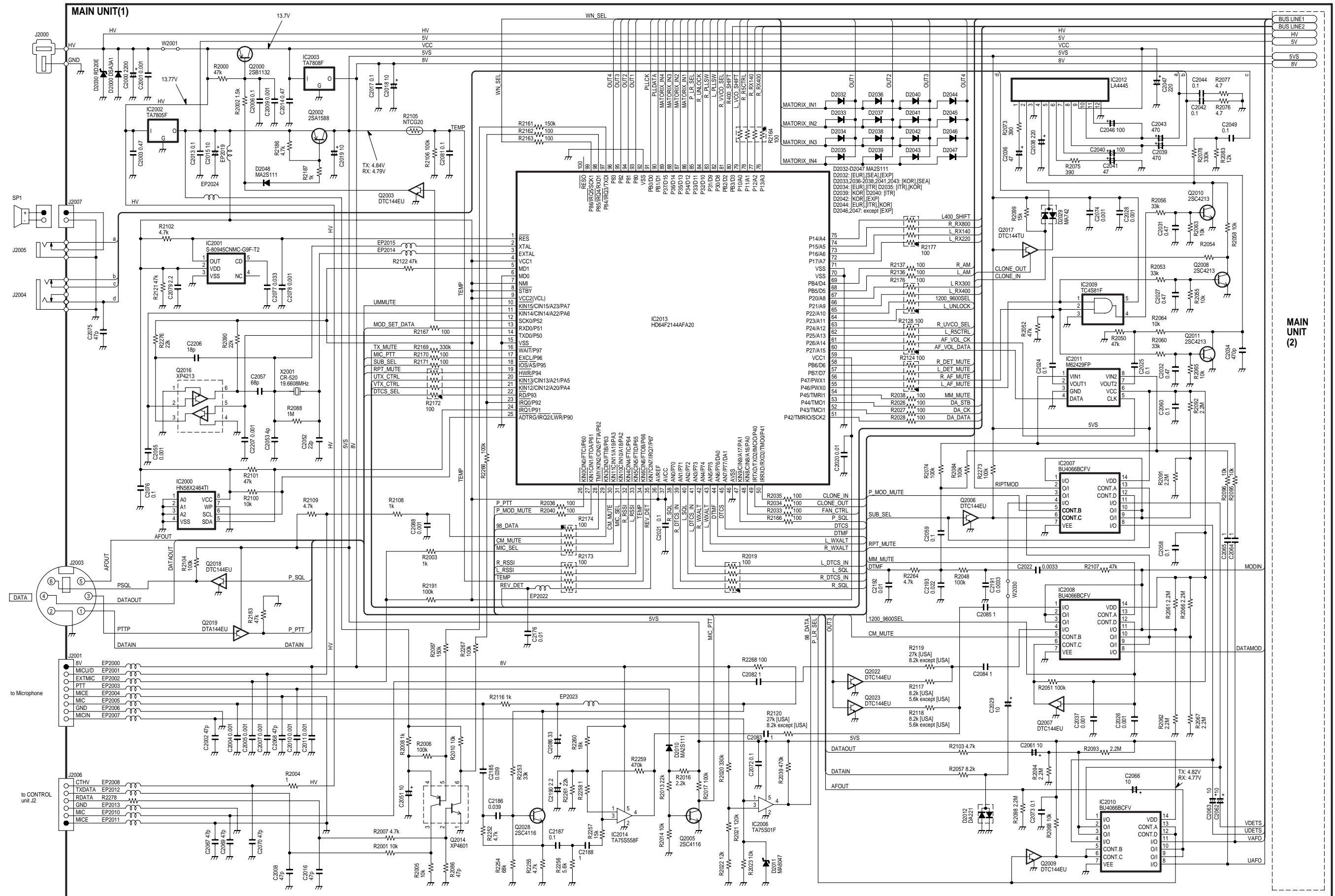

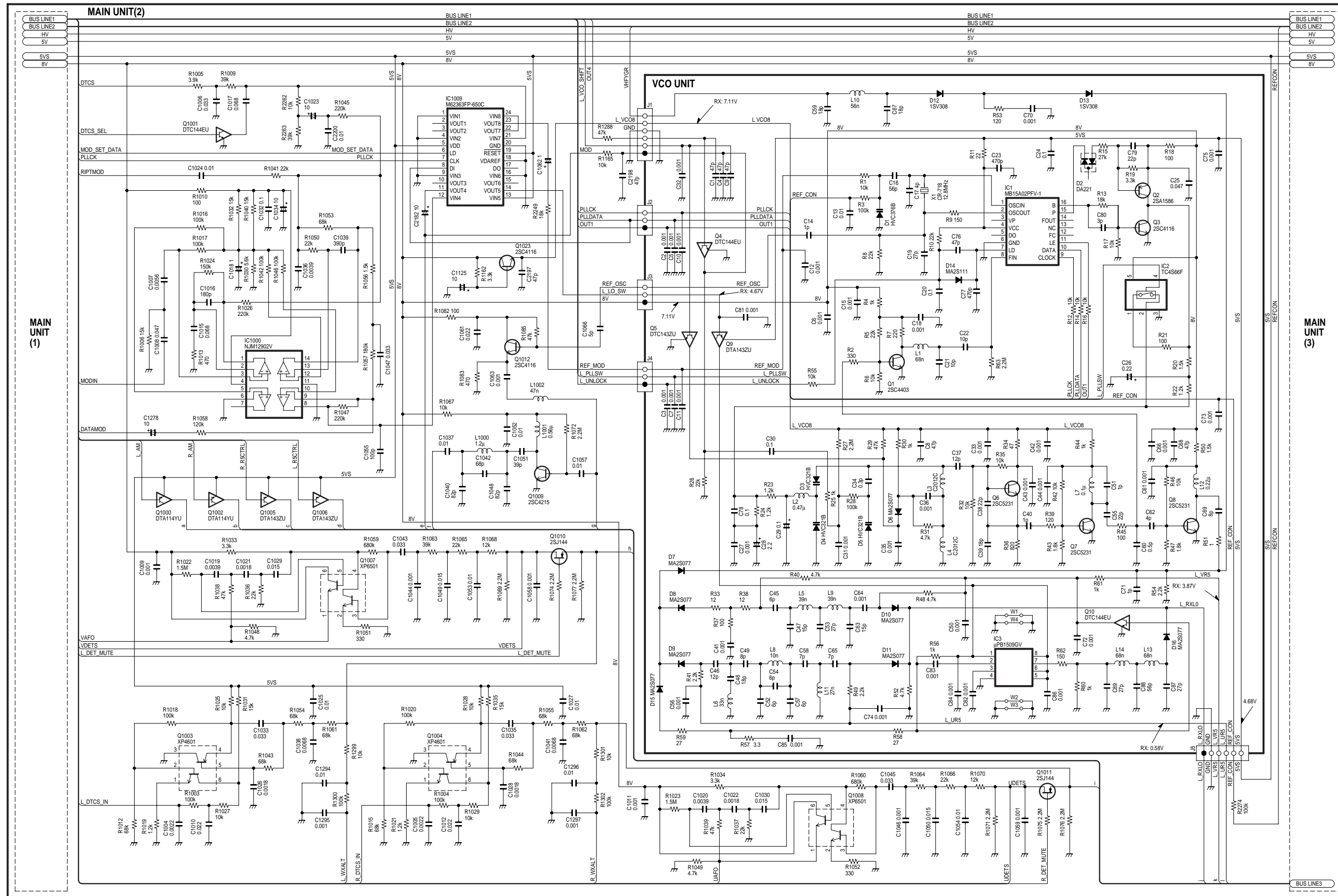

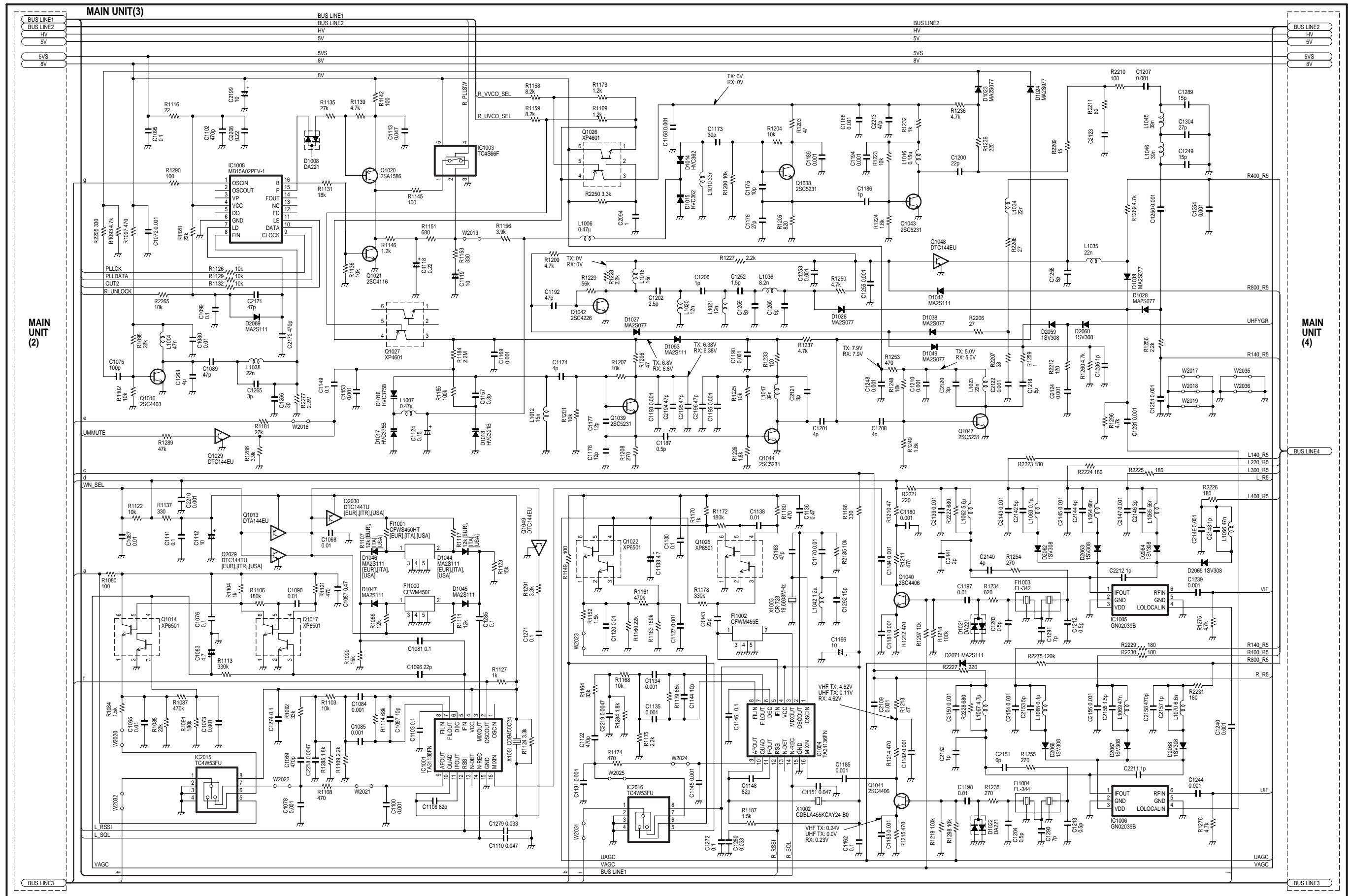

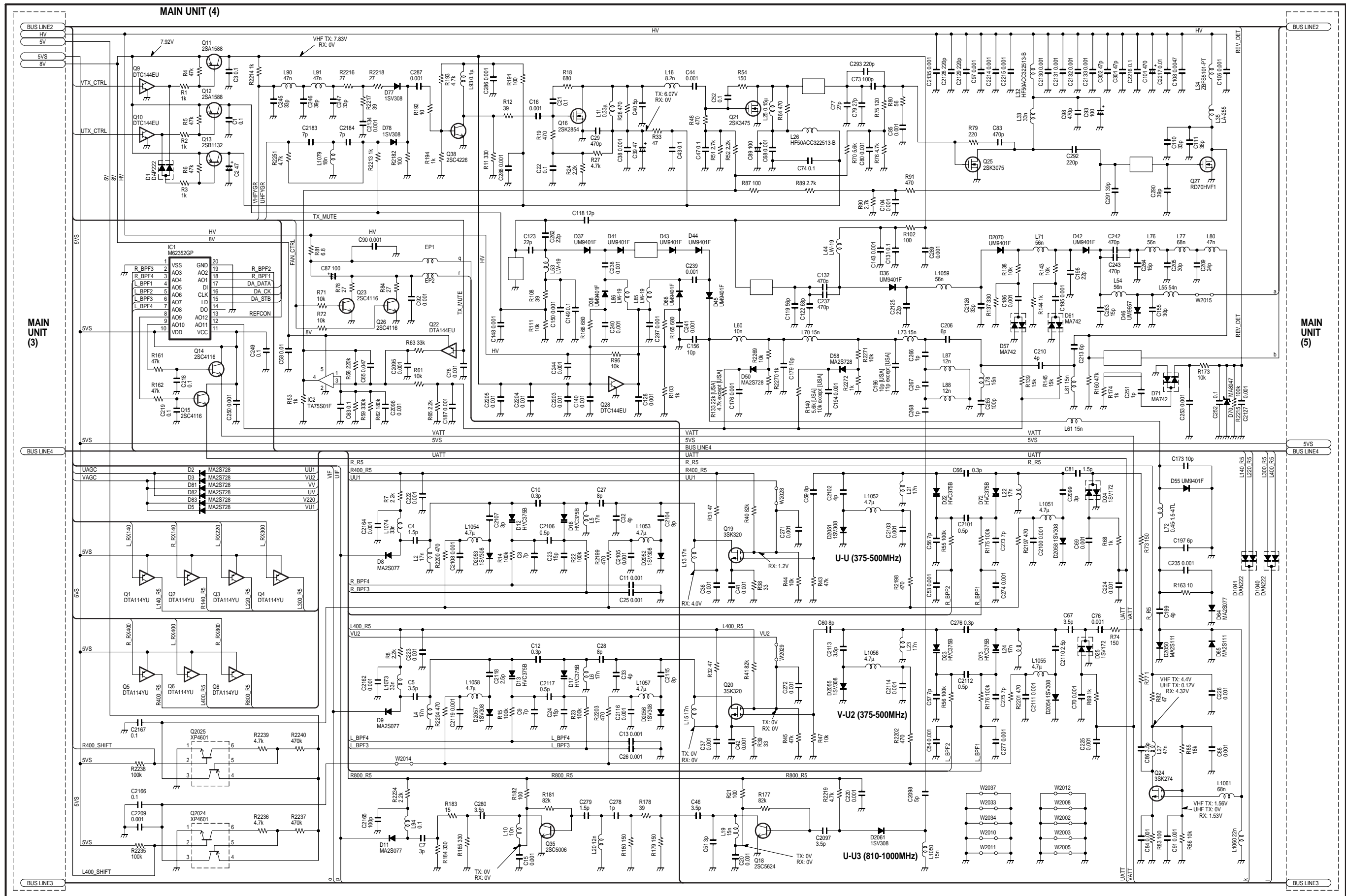

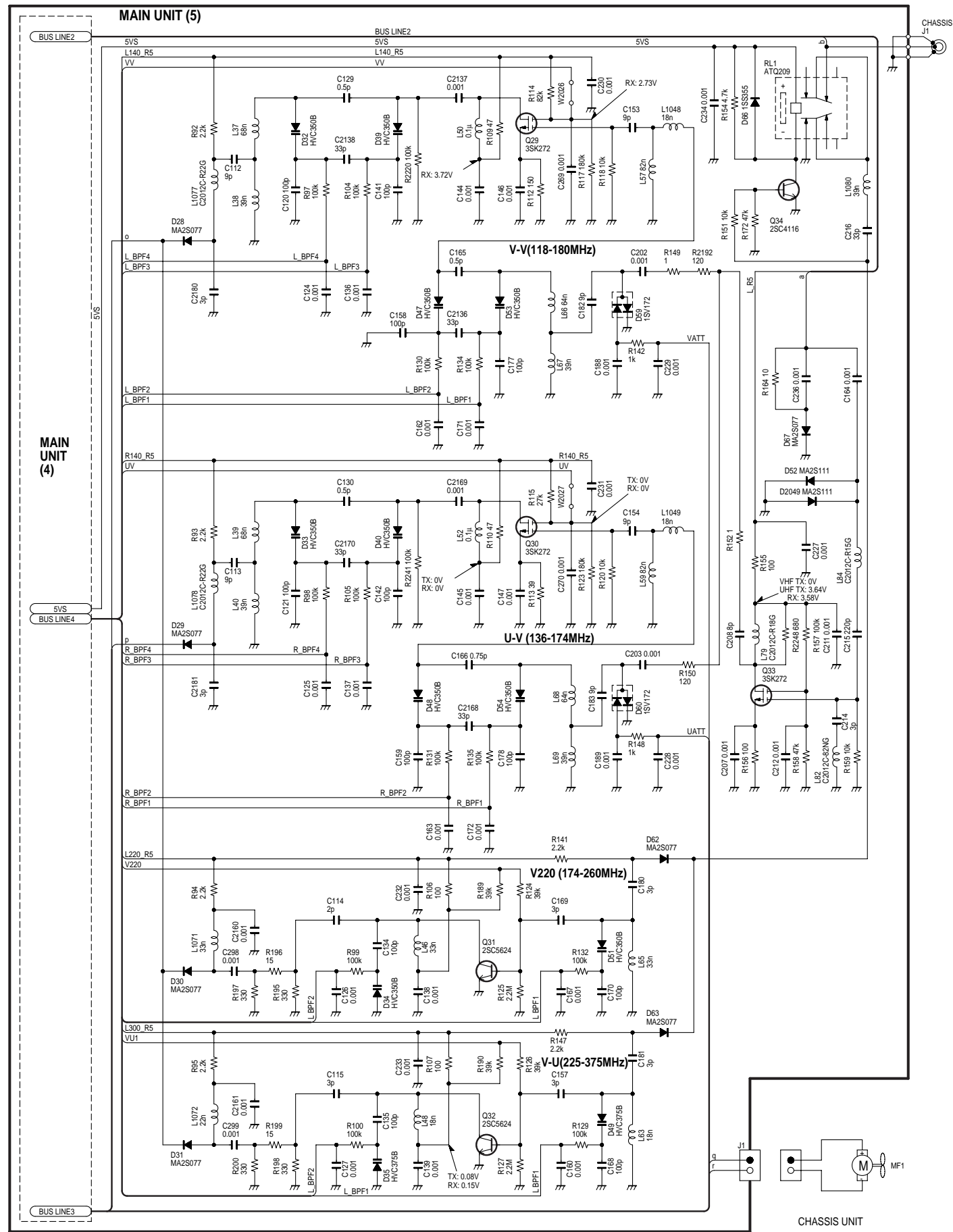

Icom Inc.

1-1-32, Kamiminami, Hirano-ku, Osaka 547-0003, Japan
Phone : 06 6793 5302
Fax : 06 6793 0013
URL : <http://www.icom.co.jp/world/index.html>

Icom America Inc.

<Corporate Headquarters>
2380 116th Avenue N.E., Bellevue, WA 98004, U.S.A.
Phone : (425) 454-8155 Fax : (425) 454-1509
URL : <http://www.icomamerica.com>
<Customer Service>
Phone : (425) 454-7619

Icom Canada

Glenwood Centre #150-6165
Highway 17 Delta, B.C., V4K 5B8, Canada
Phone : (604) 952-4266 Fax : (604) 952-0090
URL : <http://www.icomcanada.com>

Icom (Australia) Pty. Ltd.

A.B.N. 88 006 092 575
290-294 Albert Street, Brunswick, Victoria, 3056, Australia
Phone : 03 9387 0666 Fax : 03 9387 0022
URL : <http://www.icom.net.au>

Icom New Zealand

146A Harris Road, East Tamaki,
Auckland, New Zealand
Phone : 09 274 4062 Fax : 09 274 4708
URL : <http://www.icom.co.nz>

Beijing Icom Ltd.

1305, Wanshang Plaza, Shijingshan Road, Beijing China
Phone : (010) 6866 6337 Fax : (010) 6866 3553

Icom (Europe) GmbH

Communication Equipment
Himmelgeister Str. 100, D-40225 Düsseldorf, Germany
Phone : 0211 346047 Fax : 0211 333639
URL : <http://www.icomeurope.com>

Icom Spain S.L

Crta. de Gracia a Manresa Km. 14,750
08190 Sant Cugat del Valles Barcelona, SPAIN
Phone : (93) 590 26 70 Fax : (93) 589 04 46
URL : <http://www.icomspain.com>

Icom (UK) Ltd.

Unit 9, Sea St., Herne Bay, Kent, CT6 8LD, U.K.
Phone : 01227 741741 Fax : 01227 741742
URL : <http://www.icomuk.co.uk>

Icom France S.a

Zac de la Plaine, Rue Brindejonc des Moulinais
BP 5804, 31505 Toulouse Cedex, France
Phone : 561 36 03 03 Fax : 561 36 03 00
URL : <http://www.icom-france.com>

Asia Icom Inc.

6F No. 68, Sec. 1 Cheng-Teh Road, Taipei, Taiwan, R.O.C.
Phone : (02) 2559 1899 Fax : (02) 2559 1874

Count on us!

Icom Inc.

1-1-32, Kamiminami, Hirano-ku, Osaka 547-0003, Japan

S-13907HZ-C2
© 2002 Icom Inc.