

Contents

Description	1
Elimination of Licensing	1
Emergency Operation	1
Controls and Functions	2
Installation	4
Mounting the Radio Bracket	4
Mounting the Microphone Hanger	4
Connecting the Power Cords	4
Connecting the Antenna	5
CB Antenna Tips	5
Connecting an External Speaker (Optional)	5
Connecting a Public Address (PA) Speaker (Optional)	5
To Receive	6
To Transmit	7
Multi-Function Meter	8
Preventive Maintenance	9
Maintenance	9
Troubleshooting	10
Servicing Your Transceiver	11
Radio Code Definitions	12
Specifications	13
Warranty	14

Unpacking

Carefully unpack your Grant LT and check the contents against this list:

- **Grant LT** SSB/AM Mobile Transceiver
- Microphone
- Microphone Hanging Kit
- Mounting Bracket Kit
- DC Power Cord
- Reference Guide
- Part 95 Subpart D (FCC Rules)
- Product Registration Card

If any items are missing or damaged, call Uniden at 1-800-297-1023.

Please be sure to complete and mail your Product Registration Card.

Description

Your Uniden **Grant LT** represents the highest quality communications device designed for use in the Citizens Band Radio Service. It will operate on any of the 40 AM frequencies authorized by the Federal Communications Commission (FCC).



The Citizens Band Radio Service is under the jurisdiction of the Federal Communications Commission (FCC). Any adjustments or alterations which would alter the performance of the transceiver's original FCC type acceptance, or which would change the frequency determining method, are strictly prohibited. Replacement or substitution of crystal, transistors, ICs, regulator diodes, or any other part of a unique nature, with parts other than those recommend by Uniden, may cause violations of the technical regulations in Part 95 of the FCC Rules or in violation of type acceptance requirements in Part 2 of the rules.

Elimination of Licensing

The FCC has ruled that CB Radio Service operators are no longer required to obtain an FCC License to operate their CB equipment. In doing so, the FCC also decided to permit CB station operation without station identification.

Elimination of individual station licenses does not reduce the operating privileges or responsibilities of CB users. An operator of a CB radio station is still required to comply with the Communications Act and with the rules of Citizens Band Radio Service.

Emergency Operation

1. Turn the Channel Selector to Channel 9.
2. Press the microphone **PTT** switch and speak clearly.
3. If there is no response, select an active channel and ask that party to relay your emergency broadcast on **Channel 9**.



NOTE

All channels, except Channel 9 may be used for normal communication. Channel 9 is reserved by the FCC for emergency communication involving the immediate safety of individuals or protection of property. Channel 9 may also be used to render assistance to a motorist.

This is an FCC rule and applies to all operators of CB radios.



NOTE

Features, Specifications, and availability of Optional Accessories are subject to change without notice.

Uniden is a registered trademark of Uniden America Corporation.

Controls and Functions

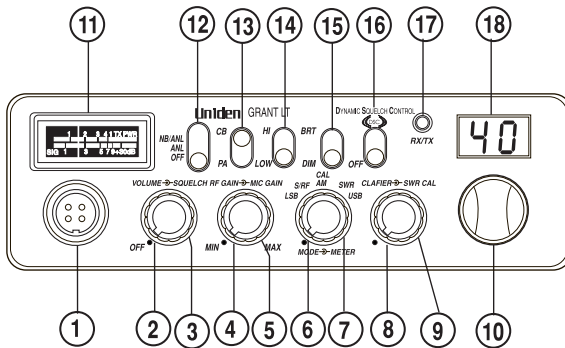

FRONT VIEW - Grant LT BACKLIGHTED PANEL

1. **Microphone Jack**
2. **OFF/VOL:** Turns radio on or off; adjusts speaker volume.
3. **SQUELCH:** Reduces background noise when there is no incoming signal.
4. **RF GAIN:** Improves reception in strong signal areas.
5. **MIC GAIN:** Adjusts microphone sensitivity.
6. **S/R/F CAL SWR** Knob: Selects function of meter.
7. **LSB AM USB** Knob: Selects mode.
8. **CLARIFIER** Knob: Fine tunes the SSB receiving signals.
9. **SWR** Knob: Calibrates the meter for Standing Wave Ratio (**SWR**) measurements.
10. **Channel** Knob: Selects channel.
11. **Multi-function Meter:** Measures **SWR**, **RF** and **S** signal strength.
12. **NB/ANL** Switch: Reduces external noise and interference from vehicle ignition systems.
13. **CB/PA** Switch: Selects PA optional (Public Address) speaker or CB.



*Do not use **PA** function unless an external speaker is connected.*

14. **HI/LOW** Switch: Hi position increases treble, Low position increases bass.
15. **BRT/DIM** Switch: Adjusts the brightness of LED Channel Display and meter lighting.
16. **DYNAMIC SQUELCH CONTROL (DSC):** Automatically sets squelch to optimal level for stronger signals.
17. **RX/TX** Indicator: Red transmitting; green receiving.

18. **Channel Display:** Displays current channel selection.

19. **ANT.:** Connects antenna cable to transceiver.



To prevent acoustic feedback, separate the microphone from the speaker when operating the **PA** at high output levels.

20. **PA. SP.:** Connects external 8-ohm 4-watt Public Address speaker.



When the external speaker is plugged in, the internal speaker is off.

21. **EXT. SP.:** Connects optional 8-ohm 4-watt speaker to remotely monitor receiver.

22. **POWER:** Connects DC power to transceiver.

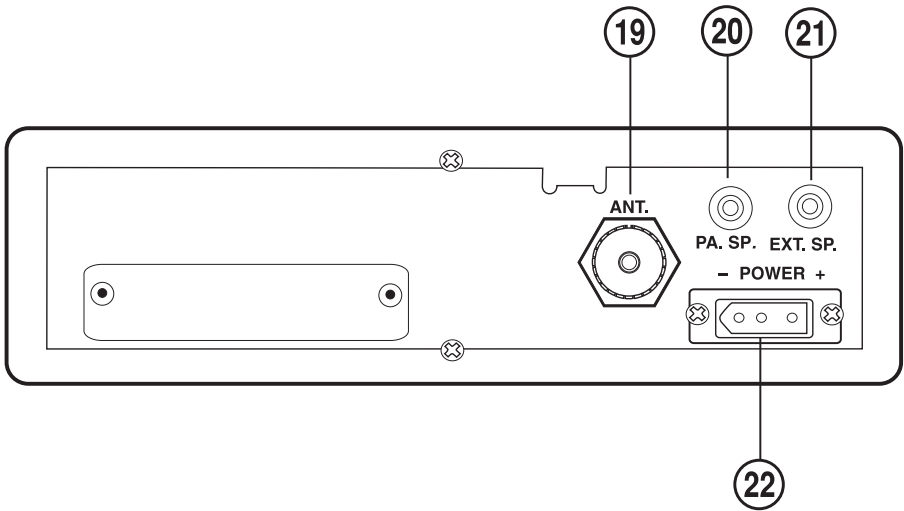

Installation

MOUNTING THE RADIO BRACKET

**NOTE**

Plan the location of the transceiver and microphone bracket before beginning installation.

1. Select a location that is convenient for operating the radio, but does not interfere with the driver or passenger.
2. Remove the mounting bracket from radio and use it as a template for marking the location of the mounting screws.
3. Drill the necessary holes and secure the mounting bracket in place using mounting screws.

MOUNTING THE MICROPHONE HANGER

Mount the microphone hanger to the side of the radio. Mounting holes are provided near the microphone connector and on the other side of the unit. Use the screws supplied. You can also mount the hanger on the dashboard, if preferred.

CONNECTING THE POWER CORDS

1. Check the vehicle battery connections to determine which battery terminal (positive or negative) is grounded to the engine block or chassis. Most of today's vehicles use a negative ground. If your vehicle has a negative ground, follow steps 2 and 3.
2. Connect the RED wire of the DC power cord to the accessory contact in your vehicle's +13.8 VDC fuse box.
3. Connect the BLACK wire of the DC power cord to the negative side of the automobile (usually the chassis).

**NOTE**

In vehicles with a positive ground, the RED wire connects to the chassis and the BLACK wire connects to the accessory contact in the fuse box.

4. Plug the DC power cord into the Power Connector on the rear panel.

Connecting the Antenna

Connect the CB antenna plug to the Antenna Connector on the rear panel. (For more information on antenna installation, please refer to the instruction guide that came with your antenna.)

CB Antenna Tips

- A vertically polarized quarter-wavelength whip antenna provides the most reliable operation and greatest range. The shorter loaded type whip antennas are more attractive and compact than the larger full quarter-wavelength whip. Although the reduced height decreases possible clearance problems, the shorter antennas may not provide the same transmitting and receiving range possible with the longer ones.
- A 3-way combination antenna allows you to operate all three bands (AM, FM, and CB) with one antenna. However, it will provide a shorter transmitting and receiving range than a standard “single band” antenna designed for CB use only. You may also notice a higher SWR with this type of antenna.

Connecting an External Speaker (Optional)

Connect an optional external speaker to the External Speaker Jack on the rear of the transceiver. For the external speaker, use an 8W speaker with at least a 4-watt rating. When connected, the external speaker automatically disables the internal speaker. The external speaker will provide high performance remote receiver monitoring.

Connecting a Public Address (PA) Speaker (Optional)

Connect an optional Public Address speaker to the PA Speaker Jack on the back of the transceiver. For the PA speaker, use an 8W speaker with at least a 4-watt rating. Be sure the PA speaker is directed away from the microphone to avoid acoustic feedback. When you are operating the PA system with high output level, greater separation and isolation between the microphone and PA speaker may be required to prevent feedback. When this unit is used as a public address system, set the CB/PA Switch to the PA position.

MOUNTING THE RADIO TO THE BRACKET

1. Align the mounting holes on both sides of the radio with the holes on the mounting bracket.
2. Insert the mounting knobs and tighten the knobs until the radio is secure.



To avoid damaging the radio casing, do not overtighten the knobs.

To Receive

NOTE

Be sure that the power source, antenna, and microphone are properly connected before proceeding.

1. Turn unit **ON** and set **VOLUME** Control to a comfortable level.

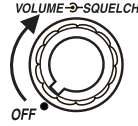

2. Select **CHANNEL**.



3. Set switch to **NB/ANL**.



Dynamic Squelch Control automatically sets Squelch to the optimal level for stronger transmission and signal clarity. To scan for weaker signals, turn **Dynamic Squelch Control** off and perform the following steps:

- 4a. Turn **SQUELCH** fully clockwise so only strong signals can get through.

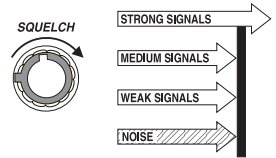

- 4b. Turn **SQUELCH** fully counter-clockwise until you hear a hiss. Everything gets through - noise, weak signals, and strong signals.

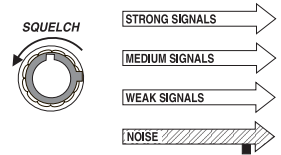

- 4c. Turn **SQUELCH** back clockwise until the hiss stops. Only clearer signals get through.

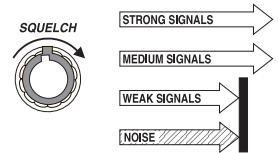

NOTE

Set **SQUELCH** *only* when the radio is not receiving a strong signal.

5. Adjust **RF GAIN** knob to optimize reception in strong signal areas.

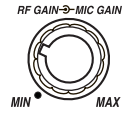

6. Adjust **CLARIFIER** knob to reduce or eliminate adjacent channel interference.

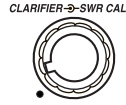

7. Set the meter selector to **S/R.F.**

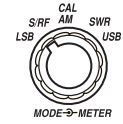

To Transmit

1. Select a channel.
2. Adjust **MIC GAIN**.



3. When the channel is clear, press the microphone **PTT** switch and speak.



If the channel is busy, do not transmit until it becomes clear.

Multi-Function Meter

SWR Meter: Measures **SWR** (standing wave ratio) of antenna. Use to check antenna system or to adjust your antenna to the proper length.

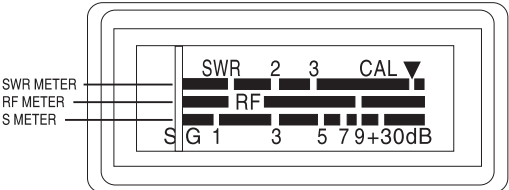

To measure **SWR**:

1. Set the Mode Selector to the **AM** position.

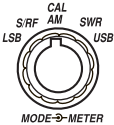

2. Set the Meter Selector to the **CAL** position.

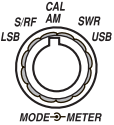

3. Press and hold the microphone **PTT** Switch. (Transmit)

4. Calibrate the meter using the **SWR CAL** Control. (Adjust the needle to the ▼ mark.) Do not talk into the microphone or set the **MIC GAIN** Control to the **MIN** position.

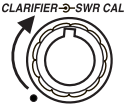

5. Move the Meter Selector to the **SWR** position while holding the **PTT** Switch.

A reading below 2 is acceptable. Higher readings indicate a problem in the antenna system. Problems may be caused by humidity, vibration, or corrosion. Check both ends of the coaxial cable connector. Also check for damage to the cable or antenna.

RF Meter: Measures RF Output Power for transmitter. To use the RF Meter, position the Meter Selector at **S/R.F.** Press the microphone **PTT** Switch to read your transmitting RF power.

S-Meter: Measures incoming signal strength. To use the S-meter, position the Meter Selector at **S/R.F.** The meter swings to indicate signal strength.
i.e. **S 3, S 5, S 7 . . .**

Preventive Maintenance

Every six months:

1. Check the Standing Wave Ratio (**SWR**).
2. Be sure all electrical connections are tight.
3. Inspect antenna coaxial cable for wear or breaks in shielding.
4. Be sure all screws and mounting hardware are tight.

Maintenance

The **Grant LT** is designed to give you years of trouble-free service. There are no user-serviceable parts inside. Except for the fuse in the DC power cord, no maintenance is required.

To replace a blown fuse:

1. Press ends of the fuse holder together. Twist to open. Carefully separate the two pieces.
2. Remove the fuse and inspect. If blown, replace with the same type fuse.

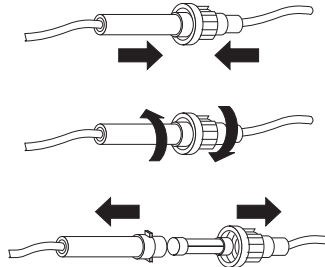

Use only the fuse specified for your **Grant LT** (4-ampere 3 AG fuse). Failure to do so may void your warranty.

Troubleshooting

Problem	Suggestion
Unit does not power on.	<p>Check the ignition key position.</p> <p>Check all connections to the DC power cord as well as the fuse inside the holder. If fuse is out, replace with a 4-ampere, 3AG fuse only.</p> <p>Check the vehicle electrical system.</p>
No reception.	<p>Make sure the microphone is properly connected.</p> <p>Set the CB/PA Switch to CB.</p> <p>Adjust the squelch and volume.</p> <p>Make sure that the antenna and its connections are not broken.</p> <p>Set the RF Gain to the full clockwise position.</p>
Poor reception.	<p>Adjust the squelch and volume.</p> <p>Check to see that the antenna SWR is 2 or below.</p> <p>Set the RF GAIN to the full clockwise position.</p> <p>Check the Mode Selector setting. If an SSB signal is being received, switch to the proper mode setting (USB or LSB).</p> <p>Adjust the Clarifier Control.</p>
No transmission.	<p>Set the CB/PA Switch to CB.</p> <p>Make sure that the microphone is properly connected.</p> <p>Set the MIC GAIN knob to the full clockwise position.</p>
Low transmission.	<p>Check to see that the antenna SWR is 2 or below.</p> <p>Set the MIC GAIN knob to the full clockwise position.</p>

If you do not get satisfactory results after performing the above checks, call the **Uniden Customer Service Center** at (800) 297-1023, 8:00 a.m. to 5:00 p.m. CST, Monday through Friday. **Do not return this product to the place of purchase. Our Uniden Representatives will be happy to help you with any question regarding the operation of this unit, available accessories or any other related matter.**

Servicing Your Transceiver

Technical information, diagrams, and charts are provided on request. It is the user's responsibility to see that this radio is operating at all times in accordance with the FCC Citizens Radio Service regulations. We highly recommend that you consult a qualified radio/telephone technician for servicing and aligning this CB radio product. Please read the Warning information on page 1 of this Guide.



When ordering parts, be sure to specify the correct model number and serial number of the unit.

Radio Code Definitions

The following list contains common “10-Codes” used by CB radio operators for faster communication and better understanding.

Code	Meaning	Code	Meaning
10-1	Received poorly	10-35	Confidential information
10-2	Receiving well	10-36	Correct time is
10-3	Stop transmitting	10-37	Wrecker needed at
10-4	OK, message received	10-38	Ambulance needed at
10-5	Relay message	10-39	Your message is delivered
10-6	Busy, stand by	10-41	Please turn to channel
10-7	Out of service, leaving air	10-42	Traffic accident at
10-8	In service, subject to call	10-43	Traffic tie up at
10-9	Repeat message	10-44	I have a message for you
10-10	Transmission completed, standing by	10-45	All units within range please report
10-11	Talking too rapidly	10-50	Break channel
10-12	Visitors present	10-60	What is next message number
10-13	Advise Weather/Road conditions	10-62	Unable to copy, use phone
10-16	Make pickup at	10-63	Net directed to
10-17	Urgent business	10-64	Net clear
10-18	Anything for us?	10-65	Awaiting your next message/assignment
10-19	Nothing for you, return to base	10-67	All units comply
10-20	My location is	10-70	Fire at
10-21	Call by telephone	10-71	Proceed with transmission in sequence
10-22	Report in person to	10-77	Negative contact
10-23	Stand by	10-81	Reserve hotel room for
10-24	Completed last assignment	10-82	Reserve room for
10-25	Can you contact	10-84	My telephone number is
10-26	Disregard last information	10-85	My address is
10-27	I am moving to channel	10-91	Talk closer to microphone
10-28	Identify your station	10-93	Check my frequency on this channel
10-29	Time is up for contact	10-94	Please give me a long count
10-30	Does not conform to FCC rules	10-99	Mission completed, all units secure
10-32	I will give you a radio check	10-200	Police needed at
10-33	EMERGENCY TRAFFIC		
10-34	Trouble at this station		

Specifications

General

Channels:	40
CB Frequency Range:	26.965 to 27.405 MHz
Frequency Control:	Phase Locked Loop (PLL) synthesizer
Frequency Tolerance:	±0.005%
Frequency Stability	0.001%
Operating Temperature:	-30°C to +50°C
Microphone:	Plug-in dynamic with PPT (push to talk) switch and d coiled cord
Input Voltage:	13.8 VDC nominal, 15.9V max, 11.7V min (positive or negative ground)
Current Drain:	TX: AM full modulation, 2.2 A SSB 120 watts, PEP output, 2A RX: Squelched, 0.25 A; with maximum audio output, 0.6A
Size:	7-7/8" (W) x 9-3/8" (D) x 2-3/8" (H)
Weight:	4 lbs. 10 oz. with microphone
Antenna Connector:	UHF, SQ-239
Meter (3-in-1)	Illuminated; indicates relative power output and received signal strength, and SWR.

Transmitter

Power Output:	AM, 4 watts SSB, 12 watts, PEP
Modulation:	High - and low-level, Class B amplitude modulation
Intermodulation Distortion:	SSB: 3rd order, more than -25dB, 5th order, more than 35dB
SSB Carrier Suppression:	55dB
Unwanted Sideband:	50dB
Frequency Response:	AM and SSB; 300 to 3000 Hz
Output Impedance:	50 ohm, unbalanced
Output Indicators:	Meter shows relative RF output power and SWR Transmit LED glows red when transmitting

Receiver

Sensitivity:	SSB: 0.25 μ V for 10 dB, (S+N)/N at greater than 1/2 watt of audio output AM: 0.5 μ V for 10 dB; (S+N)/N at greater than 1/2 watt of audio output
Selectivity:	AM: 6 dB @ 3 kHz, 50 dB; @ 9 kHz SSB: 6dB @ 1.1kHz, 60dB @ 2.3kHz
Image Rejection:	More than 65 dB
Adjacent-Ch. Rejection:	60 dB AM; 70 dB SSB
IF Frequencies:	AM: 7.8 MHz 1st IF, 455 kHz 2nd IF SSB: 7.8 MHz
Automatic Gain Control (AGC):	Less than 10 dB change in audio output for inputs from 10 to 100,000 μ V
Squelch:	Adjustable; threshold less than 1 μ V
AM and SSB RF Gain Control:	40 db adjustable for AM and SSB
Clarifier Range:	1.5 kHz
Audio Output Power:	4 watts into 8 ohms
Frequency Response:	300 to 2500 Hz
Internal Speaker:	8 ohms, round
External Speaker: (not supplied)	8 ohms, disables internal speaker when connected

PA System

Power Output:	4 watts into external speaker
External Speaker for PA speaker: (not supplied)	8 ohms

Specifications shown are typical and subject to change without notification.

Two-Year Extended Warranty

Important: Evidence of original purchase is required for warranty service.

WARRANTOR: UNIDEN AMERICA CORPORATION (“Uniden”)

ELEMENTS OF WARRANTY: Uniden warrants, for two years, to the original retail owner, this Uniden Product to be free from defects in materials and craftsmanship with only the limitations or exclusions set out below.

WARRANTY DURATION: This warranty to the original user shall terminate and be of no further effect two years after the date of original retail sale. The warranty is invalid if the Product is (A) damaged or not maintained as reasonable or necessary, (B) modified, altered, or used as part of any conversion kits, subassemblies, or any configurations not sold by Uniden, (C) improperly installed, (D) serviced or repaired by someone other than an authorized Uniden service center for a defect or malfunction covered by this warranty, (E) used in any conjunction with equipment or parts or as part of any system not manufactured by Uniden, or (F) installed or programmed by anyone other than as detailed by the owner’s manual for this product.

STATEMENT OF REMEDY: In the event that the product does not conform to this warranty at any time while this warranty is in effect, warrantor will either, at its option, repair or replace the defective unit and return it to you without charge for parts, service, or any other cost (except shipping and handling) incurred by warrantor or its representatives in connection with the performance of this warranty. Warrantor, at its option, may replace the unit with a new or refurbished unit. THE LIMITED WARRANTY SET FORTH ABOVE IS THE SOLE AND ENTIRE WARRANTY PERTAINING TO THE PRODUCT AND IS IN LIEU OF AND EXCLUDES ALL OTHER WARRANTIES OF ANY NATURE WHATSOEVER, WHETHER EXPRESS, IMPLIED OR ARISING BY OPERATION OF LAW, INCLUDING, BUT NOT LIMITED TO ANY IMPLIED WARRANTIES OF MERCHANTABILITY OR FITNESS FOR A PARTICULAR PURPOSE. THIS WARRANTY DOES NOT COVER OR PROVIDE FOR THE REIMBURSEMENT OR PAYMENT OF INCIDENTAL OR CONSEQUENTIAL DAMAGES. Some states do not allow this exclusion or limitation of incidental or consequential damages so the above limitation or exclusion may not apply to you.

LEGAL REMEDIES: This warranty gives you specific legal rights, and you may also have other rights which vary from state to state. This warranty is void outside the United States of America.

PROCEDURE FOR OBTAINING PERFORMANCE OF WARRANTY: If, after following the instructions in the owner’s manual you are certain that the Product is defective, pack the Product carefully (preferably in its original packaging). The Product should include all parts and accessories originally packaged with the Product. Include evidence of original purchase and a note describing the defect that has caused you to return it. The Product should be shipped freight prepaid, by traceable means, to warrantor at:

Uniden America Corporation

Parts and Service Division
4700 Amon Carter Blvd
Fort Worth, TX 76155
(800) 297-1023, 8 a.m. to 5 p.m., Central,
Monday through Friday