

uniden®
Beancat®

BC700A
Auto Scanner

OPERATING GUIDE

PRECAUTIONS

Before you read anything else,
please observe the following:

WARNING!

Uniden **DOES NOT** represent this unit to be waterproof.
To reduce the risk of fire or electrical shock, **DO NOT** expose
this unit to rain or moisture.

NOTE:

The installation, possession, or use of
this scanning radio in a motor vehicle
may be prohibited, regulated, or require
a permit in certain states, cities, and/or
local jurisdiction. Your local law
enforcement officials should be able to
provide you with information regarding
the laws in your community.

Table of Contents

About Your New BC700A	2
What is Scanning	2
Types of Communications	2
Where to Obtain More Information	3
Unpacking	3
Optional Accessories	3
Summary of Features	4
Installing the BC700A	5
For Home Use	5
For Mobile Use	5
Controls and Functions	7
Screens	11
Scanning Overview	13
Getting Started	13
Adjusting the Squelch	14
Programming Frequencies	14
Program Lock Feature	17
Channel Lock Out	18
A Word About Memory Back-up	19
Scanning	20
Weather Channel Scan	20
Helpful Hints	21
Troubleshooting	22
Technical Specifications	24
Warranty	

About Your New BC700A

The BC700A is not *just* a scanner. It is a brand new *information radio* with automatic scanning capabilities. The built-in Service Scan system brings you instantly into the exciting world of scanning action. What's more, you don't even have to program the scanner to begin using it!

The BC700A comes with five Service banks for monitoring police, fire/emergency, marine, air, and weather frequencies. Not only that, there's even a fully programmable bank for storing *your own private collection* of favorite frequencies.

With the BC700A, you can scan almost 1,000 channels. In addition, the BC700A has 12 separate band search capabilities for even greater scanning action.

Two Service Scan banks, POLICE and FIRE/EMG, are also programmable. So whenever you encounter a newly activated local frequency for either service category, you can add it to the bank for that category. This gives you quick access to the frequencies *you* want to hear.

So enjoy your BC700A!

What is Scanning?

Unlike standard AM or FM radio stations, most two-way communications (listed below) do not transmit continuously. The BC700A scans programmed channels at the rate of up to 100 channels per second until it locates an active frequency. When scanning stops on an active frequency, it remains on that channel as long as the transmission continues. When the transmission ends, the scanner stays on the channel for 2 more seconds, waiting for another transmission. If no response is detected, the scanning cycle resumes until another transmission is received.

Types of Communication

You will be able to monitor communication such as:

- Police and fire department (including rescue and paramedics)
- NOAA weather broadcasts (7 pre-programmed channels)
- Business/industrial radio
- Motion picture and press relay
- Utility
- Land transportation frequencies, such as trucking firms, buses, taxis, tow trucks, and railroads
- Marine and amateur (ham radio) bands
- Air band
- Public Service 800 MHz band
- And many more in the 29-54 MHz, 137-174 MHz, and 406-512 MHz ranges

Where to Obtain More Information

The Bearcat Radio Club and other similar hobby clubs have publications, information on computer bulletin boards, and even contests for the radio enthusiast. See the enclosed pamphlets for more information. Additional information is also available through your local library.

Unpacking

Carefully check the contents against this list:

- BC700A Auto Scanner
- Telescoping Antenna
- AC Adapter (Model AD-140U)
- Mobile Mounting Bracket with Hardware
- DC Power Cord
- Cigarette Lighter Power Cord
- This Operating Guide
- Registration Form (in this Operating Guide)
- Frequency Directories Order Form and other pamphlets

If any items are missing or damaged, contact your place of purchase immediately.

Complete and mail your Registration Form immediately.

Please read this Operating Guide thoroughly before operating the scanner.

Optional Accessories

The following optional accessories for your BC700A are available from your local Uniden Dealer or through the Uniden Customer Service Center by calling: (317) 842-2483, 8:00 AM to 5:00 PM EST, Monday through Friday.

BC-AT 1 Mobile Antenna - For mobile installation, use a mobile antenna designed for multi-band coverage, such as the Uniden BC-AT 1 mobile antenna.

PLG-134 Antenna Adapter - Use only if your antenna has a Motorola-type plug.

Summary of Features

The BC700A is a compact mobile/base scanner, and one of the most advanced communication products available today.

The BC700A features:

- **Super Turbo Scan*** This lightning-fast technology enables the BC700A to scan and search nearly 100 channels or steps per second. The BC700A scans about *five times faster* than any standard scanner sold in the United States. Because the frequency coverage within the service banks is so large (see below), a very fast scanning system is essential. That is why we combined our latest technology-- Super Turbo Scan-- into the BC700A.

**Super Turbo Scan: US patent pending*

Six Banks *Five pre-programmed Service banks and one standard, programmable Private bank. These banks include:*

POLICE: 739-frequency (non-erasable memory) Service bank with 20 additional programmable channels.

FIRE/EMG: 197 -frequency (non-erasable memory) Service bank with 10 additional programmable channels.

AIR: 1,160-frequency step (non-erasable memory) Service/Search bank which covers the complete AIR band, 108.000 to 136.975MHz.

MRN: 90-frequency (non-erasable memory) Service bank for all Marine channels.

WX: 7 frequency (non-erasable memory) all NOAA Weather Service Broadcasting bank.

PRIVATE: 20-channel, fully user-programmable bank.

- **12 Search Bands:** Use the [BAND] key to select a band to search.

Band	Frequency Coverage	Steps
29 - 30	29.000 to 30.000 MHz	5kHz
30 - 50	30.000 to 50.000 MHz	5kHz
50 - 54	50.000 to 54.000 MHz	5kHz
108 - 137	108.000 to 136.975 MHz (AM)	25kHz
137 - 144	137.000 to 144.000 MHz	5kHz
144 - 148	144.000 to 148.000 MHz	5kHz
148 - 174	148.000 to 174.000 MHz	5kHz
406 - 420	406.000 to 420.000 MHz	12.5kHz
420 - 450	420.000 to 450.000 MHz	12.5kHz
450 - 470	450.000 to 470.000 MHz	12.5kHz
470 - 512	470.000 to 512.000 MHz	12.5kHz
806-956	806.0000 to 823.9875 MHz	12.5kHz
	849.0125 to 868.9875 MHz	12.5kHz
	894.0125 to 956.0000 MHz	12.5kHz

Installing the BC700A

For Home Use (Desktop Installation)

1. Insert the DC plug end of the AC Adapter into the DC 13.8V jack on the rear panel.
2. Plug the AC Adapter into a standard 120V AC wall outlet.
Warning: Do not plug the AC Adapter into an outlet controlled by a wall switch. *This could cause scanner memory loss.*
3. Plug the Telescoping Antenna into the ANT connector. Extend the antenna to its full height. For frequencies higher than 406 MHz, shortening the antenna may improve the reception.
4. Use the desktop stand for a better viewing and operating angle.

Helpful Hints

- If strong interference or electrical noise is received, relocate the scanner or its antenna away from the source.
- If you are operating the scanner in a fringe area or need to improve reception, use an optional antenna designed for multi-band coverage. (You can purchase this type of antenna at a local electronics store.)
- If the optional antenna has no cable, use 50-70 ohm coaxial cable for lead-in. A mating plug may be necessary for the optional antennas.

For Mobile Use (In-Car Installation)

Mounting the Radio

1. Select an ideal location in your vehicle to mount the BC700A. Avoid a location that could interfere with your driving. In a passenger car, the ideal location is underneath the dashboard on the passenger side.
2. Use the BC700A mounting bracket as a template for marking the location of the mounting screws. Note: If there are screws already holding the dashboard, you can use the same screw holes to mount the bracket.
3. Drill the necessary holes and secure the mounting bracket in place using the screws provided.
4. Mount the radio to the bracket only after the wiring has been connected to the rear panel.

Connecting the Antenna Plug

Connect the mobile antenna plug (optional) into the ANT connector on the rear panel. (For more information on antenna installation, please refer to the instruction guide that came with your antenna.)

Connecting the Power Cord

Note: If you are not experienced in connecting accessories to the vehicle fuse box, please see your automotive dealer for advice on proper installation.

Installation for everyday use:

1. Check the vehicle battery connections to determine which battery terminal (positive or negative) is grounded to the engine block or chassis. Most of today's vehicles use a negative ground. *If your vehicle has a negative ground, follow Steps 2 and 3. Otherwise, skip to the note following Step 3.*
2. Connect the RED wire of the DC power cord to the accessory contact in your vehicle's +13.8 VDC fuse box.
3. Connect the BLACK wire of the DC power cord to the negative side of the vehicle (usually the chassis).

Note: *In vehicles with a positive ground, the RED wire connects to the chassis and the BLACK wire connects to the accessory contact in the fuse box.*

4. Insert the DC plug into the DC 13.8V jack on the back of the scanner.

Installation for Temporary Use:

A Cigarette Lighter Power Cord is provided for easy, temporary installation.

Warning: *Do not use the cigarette lighter power cord in a positive ground vehicle.*

Plug one end of the Cigarette Lighter Power Cord into the cigarette lighter jack and the other end into the DC 13.8V jack on the back of the scanner.

Controls and Functions

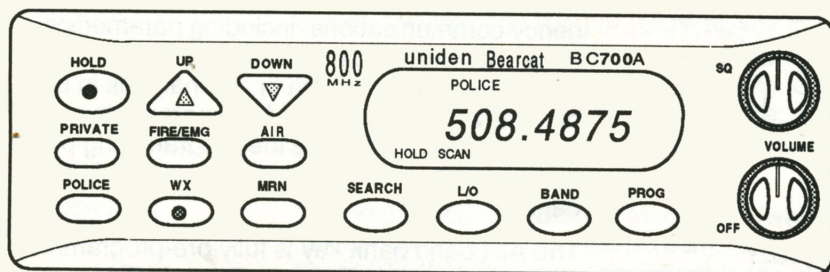

Front Panel

[HOLD] KEY

Press **[HOLD]** to stop scanning or searching. Press any bank key or **[SEARCH]** to deactivate Hold Mode. In the Hold Mode, **[UP]** and **[DOWN]** are active.

[UP] & [DOWN] KEYS

These keys are used in several different ways: *To manually step up or down a frequency in any Hold Mode, use **[UP]** or **[DOWN]**. Frequency steps are all preset for each band (see Technical Specifications).*

*To change the direction of the search during Search Mode, press **[UP]** to search upward to a higher frequency, or **[DOWN]** to search downward to a lower frequency.*

*To rapidly search or scan frequencies/channels upwards or downwards, press **[UP]** or **[DOWN]** for more than one second. To stop the search/scan, release the key.*

[PRIVATE] KEY

Use **[PRIVATE]** to instantly access your private collection of favorite frequencies. You can program up to 20 channels in the PRIVATE bank. There are no pre-programmed frequencies in this bank. After programming, press **[PRIVATE]** to activate PRIVATE scan. In the PRIVATE Scan Mode, press **[HOLD]** to stop scanning. Then use **[UP]** or **[DOWN]** to step through all 20 channels manually (including Locked Out channels).

[FIRE/EMG] KEY

Press **[FIRE/EMG]** to start scanning fire and emergency frequencies. The FIRE/EMG bank already has 197 pre-programmed frequencies. They are used for fire department and emergency communications, including paramedics. Because new frequencies may be activated in your local area, ten extra open channels in this bank have been provided for programming additional frequencies. (See the programming procedures for programming new frequencies into this bank.)

[AIR] KEY

The AIR band bank key is fully pre-programmed (108.000 to 136.975 MHz). Press **[AIR]** to start searching through all 1,160 frequency steps of the AIR band.

[POLICE] KEY

Press **[POLICE]** to start scanning police frequencies. The POLICE bank contains over 700 known frequencies used by the police, including state troopers, local police and sheriff, etc. For new frequencies, 20 more channels in this bank have been provided for you to program. (See the programming procedures for storing new frequencies into this bank.)

[WX] KEY

Seven NOAA frequencies are programmed into the Weather (WX) bank. Press **[WX]** to find your local weather channel.

[MRN] KEY

All 90 marine channels are programmed into the Marine (MRN) bank. Press **[MRN]** to start scanning marine channels.

[SEARCH] KEY

Press **[SEARCH]** to start searching active frequencies within the band previously selected with the **[BAND]** key. Normally, the search continues from the frequency where it left off in the previous search. In Search Mode, (after pressing **[SEARCH]**), the **[BAND]** key becomes active. Use **[BAND]** to select the band you wish to search. When selecting a band to search, release the key and the scanner will automatically start searching upward from the lowest frequency of its band. (The symbol appears next to "SRCH" on the display.) To search from a higher frequency to a lower frequency, press **[DOWN]**. (The symbol is now displayed next to "SRCH".)

[L/O] KEY

Press **[L/O]** to "lock out" or prevent scanning of the displayed frequency. **[L/O]** is active only during opened squelch or in the Hold Mode. Locked out channel can be displayed on the screen by using the **[UP]** or **[DOWN]** key to manually scan through the selected bank in Hold Mode only. "L/O" appears on the display to indicate that the channel is locked out. Note: Locking out a channel will not erase the programmed frequency.

[BAND] KEY

This key is active in Search Mode only (when "SRCH" is displayed on the screen). When you press **[BAND]**, the upper and lower limits of the band you are searching are displayed for 3 seconds. Then the display returns to the current frequency. Press **[BAND]** again within 3 seconds to step up one higher band. Press this key as many as it takes to find the band you want to be searched.

Important: This key has a very important secondary function. In Program Mode, you can press **[BAND]** to leave this mode.

[PROG] KEY

This key initiates and completes programming. It is active whenever a steady frequency appears on the display. Press **[PROG]** to start Programming Mode. "CH" appears and blinks, indicating you are in Programming Mode, and urges you to select the channel of the bank to be programmed. Press a programmable bank key (**[PRIVATE]**, **[FIRE/EMG]** or **[POLICE]**) to be programmed. Note: Never press non-programmable bank keys (**[WX]**, **[AIR]** or **[MRN]**). If you press one of these keys, "Error" will be displayed, and you may lose the frequency you wanted to program.

VOLUME Control/ Power Switch

This control turns the scanner on or off, and also adjusts the volume.

SQ (Squelch) Control

Adjust **[SQ]** to set the scan threshold. When you are monitoring a single channel in Manual Mode, adjust **[SQ]** to eliminate the background rushing noise heard in the absence of an incoming signal.

LCD Display

The liquid crystal display (LCD) shows the current channel or its frequency. It also displays the mode indicators, status indicators, and bank indicators. (See the Screens section for more information.)

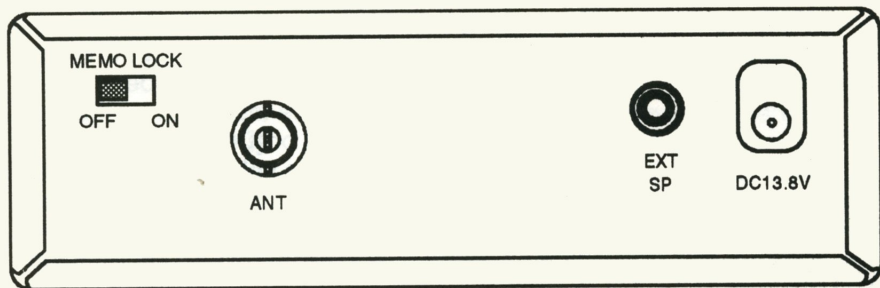

Rear panel

MEMO LOCK Switch In the ON position, the Program ([**PROG**]) key is disabled. This prevents any unauthorized programming or accidental entries. When programming is disabled, pressing [**PROG**] emits an error entry tone and displays "Prg-Loc".

ANT. (Antenna) Connector Connect your Antenna plug here. If you have a Motorola-type plug, use the optional adapter (PLG 134).

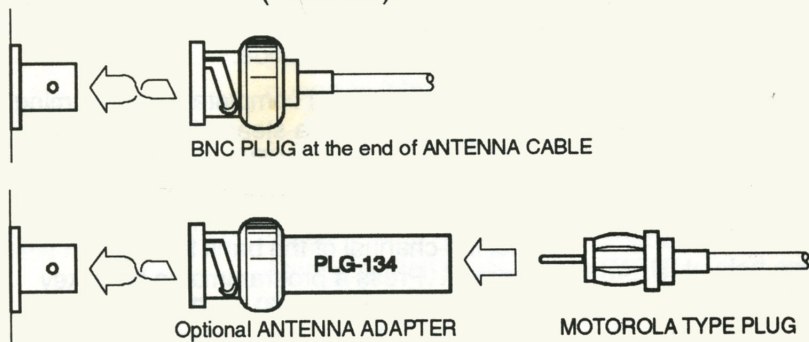

EXT. SP. (External Speaker) Connector

When using an optional External Speaker system, connect the External Speaker plug here.

DC 13.8V Power Connector

Connect the DC power cable here. Note: Use only the specified AC Adapter or DC power cord.

Screens

The following illustrate some of the screen displays you will use:



The digits and words on the screen at the left are shown for reference only. They do not all display at the same time.

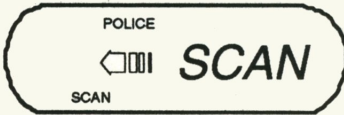

SCAN Screen

"SCAN" scrolls through the display right to left. The display shows scanning the POLICE bank.

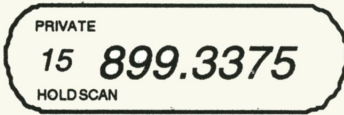

SCAN, HOLD Screen (In PRIVATE bank)

This screen displays the channel number and frequency the scanner has stopped at. The [HOLD] button has also been pressed. When scanning stops on an active frequency, it displays like this screen, but without "HOLD" showing.

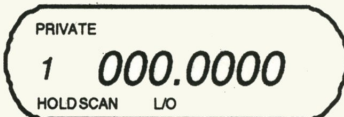

Open Channel Screen

If you press the [PRIVATE] key without programming the bank, you will see the screen at left. "L/O" is displayed for all open channels.

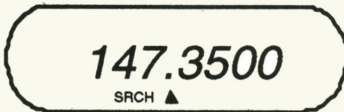

Search Screen

When Search stops on a frequency, you will see a display like that shown at the left. ▲ indicates upward search, and ▼ downward search.

144 - 148

SRCH

Band Screen

When pressing [BAND] in the Search Mode, the band you are currently searching appears on the display. Press [BAND] again within 3 seconds to change the band. This display changes automatically to the Search Screen.

Prg-Loc

HOLD SCAN

Programming Lock Screen

When you see this screen, you will not be able to do any programming. Press any bank key or [SEARCH] to erase this display.

Error

Programming Error Screen

When you try to program a frequency into any of the non-programmable banks, "Error" appears on the display.

CH
HOLD

508.9375

Programming Mode Screen

When you enter the Programming Mode, "CH" blinks next to the frequency on the display. You can now select a bank to program.

PLACE
FIRST CLASS
STAMP
HERE

uniden[®]

4700 Amon Carter Boulevard
Fort Worth, Texas 76155

ATTN: MARKET RESEARCH DEPARTMENT

Please do not send any products or service-related correspondence to this address

Product Registration Card

Thank you for choosing a Uniden Product. You have chosen one of the most sophisticated, technologically advanced electronic products available. Please fill in the requested information on this card so that we can better understand our customers and their needs. With this information we can plan new products, advertising, and guide our customer service programs. Thanks for your help.

1. Mr. 2. Mrs. 3. Ms. 4. Miss

5. First Name _____ 6. Initial _____ 7. Last Name _____

8. Street _____ 9. Apt. No. _____

10. City _____ 11. State _____ 12. ZIP _____

13. Date of Purchase _____ Month _____ Day _____ Year _____

14. Model No. _____ Serial No. _____

15. Where did you purchase the Product? 21. Occupation

<input type="checkbox"/> Catalog Showroom	<input type="checkbox"/> Business/Professional
<input type="checkbox"/> Department Store	<input type="checkbox"/> Civil Servant
<input type="checkbox"/> Discount Store	<input type="checkbox"/> Clerical
<input type="checkbox"/> Electronics Specialty Store	<input type="checkbox"/> Craftsworker
<input type="checkbox"/> Gift	<input type="checkbox"/> Executive/Administrator
<input type="checkbox"/> Local Electronics Dealer	<input type="checkbox"/> Farmer/Agriculture
<input type="checkbox"/> Mail Order	<input type="checkbox"/> Homemaker
<input type="checkbox"/> Truck Stop	<input type="checkbox"/> Machine Operator/Laborer
	<input type="checkbox"/> Military

17. Dealer Address:

18. How did you become aware of this product?

- TV Advertisement
- Magazine Advertisement
- Newspaper Advertisement
- Store Display
- Friend's Recommendation
- Salesperson's Recommendation
- Previous Use

19. Please check two of the most important factors that most influenced your purchase of this product.

- Features
- Previous Use
- Price
- Quality
- Reputation
- Style or Appearance
- Warranty

20. Please check your age category.

- Under 20
- 20 - 25
- 26 - 30
- 31 - 35
- 36 - 40
- 41 - 45
- 46 - 50
- 51 - 55
- 56 - 60
- 61 - 65
- 66 & Over

22. Please check your approximate family income.

- Under \$10,000
- \$10,000 - 19,999
- \$20,000 - 29,999
- \$30,000 - 39,999
- \$40,000 - 49,999
- \$50,000 - 59,999
- \$60,000 & Over

23. What types of credit cards do you use?

- American Express, Diners Club, Carte Blanche
- Bank Card (Master Card, Visa, etc.)
- Department Store Card
- Gasoline Card, Name _____
- None of the above

24. What type of vehicle(s) do you drive?

- Compact
- Full Size
- Mid Size
- Motor Cycle
- Pick Up
- Recreation Vehicle
- Specialty
- Sports
- Station Wagon
- Van

25. What magazine(s) do you read?

- Auto Week
- Better Homes and Gardens
- Car & Driver
- Consumer Reports
- Cosmopolitan
- Ladies Journal
- Motor Trend
- Newsweek
- People
- Popular Mechanics
- Popular Science
- Road & Track
- Sports Illustrated
- Time
- Other _____

Thank you for taking the time to complete this questionnaire. If you have any other comments or suggestions, please write to:

UNIDEN AMERICA CORPORATION
Product Development Dept.
4700 Amon Carter Boulevard
Fort Worth, Texas 76155

Scanning Overview

You can scan in one of three ways:

- **Service Bank Scanning** Press one of the five service bank keys, [POLICE], [FIRE/EMG], [AIR], [WX] or [MRN], to find an active frequency.
- **Band Search** Select a frequency band to search. The Search function is different from scanning. It searches for any active frequency step by step within the lower and upper limits of the band. When an active frequency is found, the scanner will stop and stay on that frequency as long as that transmission lasts. If that frequency is interesting to you, press [HOLD] to hold the frequency in the display. Then program it into one of the programmable banks (PRIVATE, POLICE or FIRE/EMG). If you do not want to program that frequency, press [SEARCH] or just wait till the transmission ends. The search resumes automatically 2 seconds after the last transmission and looks for more active frequencies.
- **PRIVATE Bank Scanning** If you have programmed frequencies into this bank, press [PRIVATE] to scan only those that you have programmed in this bank.

When scanning stops on an active frequency, it remains on that channel as long as the transmission continues. When the transmission ends, the scanner will remain on the same channel for 2 more seconds, waiting for a responding transmission. If there is no responding transmission within 2 seconds, the scanning cycle resumes.

Getting Started

The following instructions apply when using your BC700A for the very first time. Each time you turn on the scanner, it always retains the previous settings in its memory. That is, the scanner operates in the mode and bank last used, until you change the settings. Note: In case of memory loss to the scanner (indicated by "MEMO LOSS" on the display), all settings will be lost. Memory loss occurs if the the scanner is left for a long period of time without power.

1. Turn the Squelch [SQ] Control fully clockwise to the end.
2. Power on the scanner by turning [VOLUME] clockwise. Adjust the volume to where you can hear a steady noise.
3. Set the squelch at the scanning threshold by turning [SQ] counterclockwise just until the noise disappears.

4. Press any of the Service bank keys: **[POLICE]**, **[FIRE/EMG]**, **[AIR]**, **[WX]**, or **[MRN]**. The scanner automatically starts scanning the selected bank.

Note: Later, when you have learned how to program channels in the **PRIVATE** bank, you can press **[PRIVATE]** to scan your favorite collections.

5. Adjust the volume to a comfortable listening level.

Adjusting the Squelch

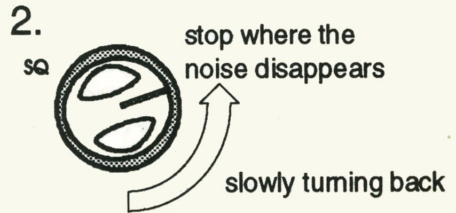

1. Open the squelch by turning **[SQ]** clockwise to the end. You should hear a steady sound (scanning stops).
2. Turn **[SQ]** counterclockwise slowly until the sound disappears. This is the threshold point at which scanning starts. At the squelch threshold, an incoming signal just slightly stronger than the noise will open the squelch.

Note: When squelch is open, you can hear the voice (scanning is stopped). If squelch is set too tight, that is, too far counterclockwise from the threshold point, a stronger signal is required to open the squelch.

If squelch is set on a point clockwise from the threshold, you will hear a constant sound (noise, if no signal is present). The scanner will not scan.

Programming Frequencies



Before you can scan the **PRIVATE** bank, you must program the channels. You can program one frequency per channel. Press **[PROG]** to start the Program Mode and also to complete the programming. If you do not want to finish programming, press **[BAND]** to leave the Program Mode.



- You can program any displayed frequency on the screen.
- If you do not know any local frequency to program, find an active frequency by scanning any service bank or searching any selected band. Then, when you find a desired frequency, program that frequency to the **PRIVATE** bank. Note: It is recommended that you do not program a Weather frequency into the **PRIVATE** bank.



- You can also program a non-active frequency. If you know a local frequency, press **[SEARCH]**. Then press **[BAND]** to select the band which covers that frequency. When the search is near the frequency you want displayed on the screen, press **[HOLD]** to stop searching. Then use **[UP]** or **[DOWN]** to display the frequency you want to program.

Example 1: Programming from SCAN mode.

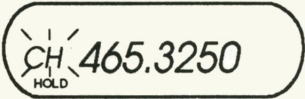
When you find an interesting active frequency while scanning the POLICE bank, and want to program it into the PRIVATE bank:

1.  Press:  **HOLD** appears on the display.

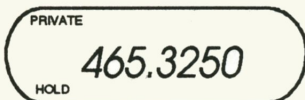
2.  Press:  **CH** appears and blinks to indicate that you are in the Programming Mode. To change the displayed frequency, use  while **CH** is blinking.

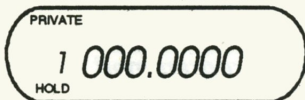

3.  Press:  **PRIVATE** appears on the display.

 **2** screens alternate to indicate that Channel 1 is available to be programmed.

The scanner automatically selects an open channel (000.0000) with the lowest channel number for easy programming. If all 20 channels have been programmed (there are no open channels in the PRIVATE bank) the channel last used will be automatically selected.

To program a frequency (eg. 465.325 MHz) into another channel, use  to select the desired channel.

If you want to cancel programming, press  to escape from Programming Mode.

4.  Press:  to end programming.

Example 2: Programming from SEARCH mode.

When you find an interesting active police frequency while searching 806 - 956 band, and want to program it into the POLICE bank:

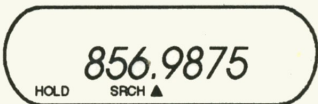
- 

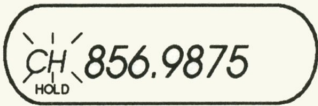
1. Press:  **HOLD** appears in the display.
- 

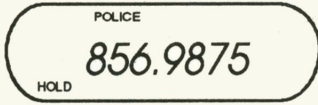
2. Press:  **CH** appears and blinks to indicate that you are in the Programming Mode.
- 

3. Press:  **POLICE** appears on the display.

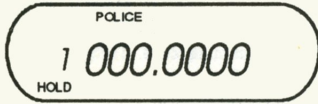

2 screens alternate to indicate that Channel 1 is available to be programmed.

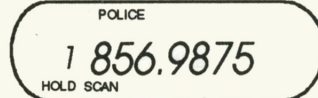
.If you wish to cancel programming, press  to escape from Programming Mode.
- 

4. Press:  to end programming.

Example 3: Programming "000.0000" (Erase programmed frequency in a channel).

You can erase a programmed frequency in a channel by programming "000.0000" into its channel. You can find and display "000.0000" on the screen in one of two ways:

Find an open channel in the private bank. Press [**PRIVATE**] then [**HOLD**], and use [**UP**] and [**DOWN**] to scroll through the bank to find an open channel, "000.0000"

- OR -

Find "000.0000" from the Search & Program Mode. Every search band has one "000.0000" display included between the band limits. It can be displayed only in the Program Mode (after pressing [**PROG**] and "CH" is blinking in the display).







Example: To find "000.0000" in Search Band 50 - 54.

1. Select Search Band 50 - 54 by pressing [BAND] in the Search Mode.
2. Press [HOLD] to stop searching.
3. Press [PROG] to go into Program Mode.
4. Use [UP] and [DOWN] to display "50.0000" or "54.0000".
5. Press [DOWN] one time at the "50.0000" screen to display "000.0000"

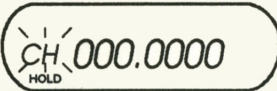
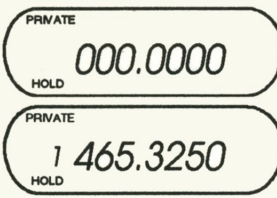
- OR -

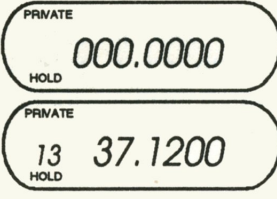
Press [UP] one time at the "54.0000" screen to display "000.0000".

Example 4: Erasing a programmed frequency in Channel 13 of the PRIVATE bank.

1.  Find this screen in the Programming Mode.
2.  Press: 
PRIVATE appears in the display.
2 screens alternate to indicate that Channel 1 is ready to be programmed.
3.  Use  or  to select Channel 13.
Now, Channel 13 is ready to be programmed.
4.  Press:  to end programming.
The frequency of Channel 13 is erased and now it is an open channel. L/O appears on the display because the scanner locks out all open channels automatically.

Program Lock Feature

The BC700A has a program lock feature [Memory Lock] to prevent accidental programming entries or unauthorized programming. Simply turn on the MEMO LOCK switch on the rear panel to disable [PROG] and protect the memory.

Channel Lock Out

- You can lock out a channel so it is not scanned. This does not erase the frequency from the channel when it is locked out.
- You can lock out all the channels in a bank, if desired. However, if you do, pressing that bank key will emit an error tone and the scanner will not scan.
- In the POLICE bank, MRN bank, or FIRE/EMG bank, you can lock out all the factory pre-programmed channels (those frequencies that display without channel numbers in Scan Mode). This enables you to make a secondary private bank, if desired.
- You cannot lock out any frequency in the WX or AIR banks. These banks are frequency search banks, and you cannot lock out any frequency in Search Mode.
- **[L/O]** is active only when squelch is opened (scan is stopped) or in Hold Mode.

Locking Out an Unwanted Channel

In Scan Mode, press **[L/O]** when the scanner stops on a channel you do not want to hear. The scanner locks out that channel and immediately advances to the next channel to resume scanning.

In Scan/Hold Mode, press **[L/O]** to lock out the displayed channel/frequency. In this case pressing **[L/O]** will not advance to the next channel. "L/O" will appear on the screen to indicate that the displayed channel is locked out.

Searching for Locked Out Channels

In Scan Mode, you will not see locked out channels. However, to search for locked out channels and display them on the screen, use **[UP]** and **[DOWN]**. These keys will enable you to search manually through the bank in Hold Mode only. "L/O" will appear on the screen to indicate the locked out channel.

Restoring a Locked Out Channel

Suppose you want to unlock Channel 12 of the PRIVATE bank. Press **[PRIVATE]** to start scanning. Press **[HOLD]** to stop scanning. ("HOLD" & "SCAN" must appear on the screen.) Use **[UP]** or **[DOWN]** to find locked out Channel 12 (which shows "L/O"). Then press **[L/O]**. "L/O" disappears to indicate that Channel 12 is now unlocked and restored for scanning.

Restoring All Locked Out Channels

You can unlock all locked out channels in any bank at one time. To do this, first press a bank key to start scanning. Then press **[HOLD]** to stop scanning. Press and hold down **[L/O]** ("L/O" appears on the screen) for more than 2.5 seconds until you hear the multi-beep ("L/O" disappears). Now all locked out channels in the bank are unlocked and restored for scanning.

A Word About Memory Back-up

Your BC700A has a convenient type of memory back-up system. In the event of a power failure, the scanner provides approximately 30 days of memory retention so you don't immediately lose the frequencies you stored in any of the channels.

Scanning

To start scanning, press any bank key.

When the BC700A is scanning, you can see the "SCAN" message moving across the display. Scanning stops on any active channel automatically and displays its frequency, except those channels programmed with L/O (Lock Out). Scanning resumes automatically two seconds after the channel becomes inactive.

To stop scanning at any time, press **[HOLD]**. When you press **[HOLD]**, you are in the Scan/Hold Mode. The scanner remains on the displayed channel until you press any bank key again to resume scanning. (Or, you can press **[SEARCH]** to start searching.)

In the Scan/Hold Mode, each time you press **[UP]** or **[DOWN]**, you step up or down one channel at a time (one frequency step each for the AIR or WX bank). Press and hold **[UP]** or **[DOWN]** to rapidly step through that bank. In the Scan/Hold mode, you do not skip a locked out (L/O) channel using **[UP]** or **[DOWN]**.

Weather Channel Scan

The BC700A allows you to search for your local NOAA weather channel.

Press **[WX]** to find the active weather channel in your area from 7 pre-programmed NOAA channels. To exit Weather Mode, press any other bank key or **[SEARCH]**.

It is possible that your area is covered by more than one weather station.

When you press **[WX]**, the BC700A will find an active broadcast immediately. If the broadcast sounds weak and distant, press **[WX]** again to look for a closer station.

Note: *All weather channels transmit continuous broadcasts. Once the Weather scan stops on a transmission, it will remain on that channel. Weather scan will not resume automatically. You must press **[WX]** again to reactivate scanning. In some parts of the country, you may not be able to monitor weather broadcasts, such as in low-lying areas. Normally a higher location will improve the reception.*

Note: *It is not recommended to program a weather frequency into any banks. Because weather channels transmit continuously, the scanner will stop on that channel, disrupting the scanning cycle. The Weather Scan feature was provided specifically to avoid this occurrence.*

Helpful Hints

General Use

- Turn the scanner off before disconnecting the power.
- Always write down the programmed frequencies in the event of memory loss. If memory is lost, simply reprogram each channel. The display shows "MEMO LOSS" when memory is lost.
- Always press each keypad button firmly until you hear the entry tone for that key entry.

Location

- If strong interference or electrical noise is received, relocate the scanner or its antenna away from the source of the noise. A higher elevation, if possible, may provide better reception. You might also try changing the height or angle of the telescoping antenna.
- Do not use the scanner in high-moisture environments such as the kitchen or bathroom.
- Avoid placing the unit in direct sunlight or near heating elements or vents.
- Do not plug the scanner into an outlet controlled by a wall switch as prolonged periods without power will cause scanner memory loss.

Cleaning

- Disconnect the power to the unit before cleaning.
- Clean the outside of the scanner with a mild detergent.
- To prevent scratches, do not use abrasive cleaners or solvents. Be careful not to rub the LCD window.
- Do not use excessive amounts of water.

Repairs

- Do not attempt any repair. The scanner contains no serviceable parts. Contact the Uniden Customer Service Center or take it to a qualified repair technician.

Birdies

All radios are subject to receiving undesired signals or birdies. If your scanner stops during SEARCH mode and no sound is heard, it may be receiving a birdie. Birdies are internally-generated signals inherent in the electronics of the receiver. If the interference is not severe, you might be able to turn **[SQ]** counterclockwise to cut out the birdie. Or, press **[SEARCH]** to resume searching. (Known birdie frequencies for the BC700A are: 31.200, 41.600, and 52.000 MHz)

Troubleshooting

If your BC700A is not performing properly, try the steps listed below.

PROBLEM	SOLUTION <i>*Applies to mobile installation only</i>
Scanner won't work	<ul style="list-style-type: none"> ● Check the connections at both ends of the AC Adapter.
	<ul style="list-style-type: none"> ● Turn on the wall switch of your room. You could be using an outlet controlled by the wall switch. Move the AC Adapter to another wall outlet.
	<ul style="list-style-type: none"> * Check the connections at both ends of the DC cord or cigarette lighter cord.
	<ul style="list-style-type: none"> * <i>Check to see if the fuse is blown. If the fuse is blown</i>
	<ul style="list-style-type: none"> * <i>Make sure the ignition key is at the Accessory position.</i>
	<ul style="list-style-type: none"> * <i>Make sure the power switch is turned on.</i>
Improper reception.	<ul style="list-style-type: none"> ● Check the antenna and its connection.
	<ul style="list-style-type: none"> ● When you are using a telescoping antenna
	<ul style="list-style-type: none"> ● You may be in a fringe area. This may require an optional multi-band antenna. Check with your dealer or local electronics store.
	<ul style="list-style-type: none"> ● Check and adjust
Scan won't stop.	<ul style="list-style-type: none"> ● Check and adjust Squelch (see "Adjusting the Squelch").
	<ul style="list-style-type: none"> ● Check the antenna connection.
	<ul style="list-style-type: none"> ● For the PRIVATE bank scan
	<ul style="list-style-type: none"> ● It is possible that none of the programmed frequencies are active at the time. Try the band search.

PROBLEM	SOLUTION
Scan won't start.	• Press the bank key again.
	• Adjust the Squelch Control.
	• For the PRIVATE bank scan
Search won't start.	• Adjust Squelch.
PROGRAM key won't work.	• Scan or search must first be stopped.
	• Programming lock is ON.

If you still cannot get satisfactory results and want additional information, or to return the unit for service, please call or write the Uniden Parts and Service Division. The address and phone number are listed in the Warranty (at the end of this manual).

Technical Specifications

Banks: **Total 6 banks:** 5 Service banks and 1 standard bank.
POLICE: 739 programmed plus 20 programmable channels
FIRE/EMG: 197 programmed plus 10 programmable channels
AIR: 1,160 programmed. (All aircraft)
MRN: 90 Programmed. (All Marine)
WX: 7 programmed. (All NOAA weather service)
PRIVATE: 20 channels fully user programmable

(Total 50 programmable channels)

Search Band: **Total 12 Search bands:** (All NFM except aircraft band)

Display	Frequency Coverage	Steps
29 - 30	29.000 to 30.000 MHz	5kHz
30 - 50	30.000 to 50.000 MHz	5kHz
50 - 54	50.000 to 54.000 MHz	5kHz
108 - 137	108.000 to 136.975 MHz (AM)	25kHz
137 - 144	137.000 to 144.000 MHz	5kHz
144 - 148	144.000 to 148.000 MHz	5kHz
148 - 174	148.000 to 174.000 MHz	5kHz
406 - 420	406.000 to 420.000 MHz	12.5kHz
420 - 450	420.000 to 450.000 MHz	12.5kHz
450 - 470	450.000 to 470.000 MHz	12.5kHz
470 - 512	470.000 to 512.000 MHz	12.5kHz
806-956	806.0000 to 823.9875 MHz	12.5kHz
	849.0125 to 868.9875 MHz	12.5kHz
	894.0125 to 956.0000 MHz	12.5kHz

Sensitivity: **12 dB SINAD.**
(Nominal)

0.3 μ V	29.000 - 54.000MHz
0.4 μ V	137.000 - 174.000MHz
0.4 μ V	406.000 - 512.000MHz
0.9 μ V	108.000 - 136.975MHz
0.4 μ V	806.000 - 956.000MHz

Scan Rate: Up to 100 channels per second.

Scan Delay: 2 seconds

Audio Output: Max 3W

Antenna: 50 ohms (Impedance)

Operating Temperature: -20°C (-4°F) to +60°C (+140°F)

Size: 5-1/5" (W) x 6-15/16" (D) x 1-5/8" (H)

Weight: 1 lb 11oz.

Certified in accordance with FCC Rules and Regulations Part 15 Subpart C as of date of manufacture.

Features, specifications, and availability of optional accessories are all subject to change without notice.

One Year Limited Warranty

WARRANTOR: UNIDEN AMERICA CORPORATION ("UNIDEN")

ELEMENTS OF WARRANTY: UNIDEN warrants, for one year, UNIDEN Scanners (hereinafter referred to as the Product) to be free from defects in materials and craftsmanship with only the limitations or exclusions set out below.

WARRANTY DURATION: This warranty shall terminate and be of no further effect one (1) year after the date of the original purchase of the Product or at the time the Product is (A) damaged or not maintained as reasonable or necessary, (B) modified, (C) improperly installed, (D) repaired by someone other than warrantor for a defect or malfunction covered by this warranty, (E) used in a manner or purpose for which the Product was not intended, or (F) sold by the original purchaser.

STATEMENT OF REMEDY: In the event that the Product does not conform to this warranty at any time while this warranty is in effect, warrantor will repair the defect and return it to you without charge for parts, service, or any other cost (except shipping and handling) incurred by warrantor or its authorized service centers in connection with the performance of this warranty. **THE ONE YEAR LIMITED WARRANTY SET FORTH ABOVE IS THE SOLE AND ENTIRE WARRANTY PERTAINING TO THE PRODUCT AND IS IN LIEU OF AND EXCLUDES ALL OTHER WARRANTIES OF ANY NATURE WHATSOEVER, WHETHER EXPRESS, IMPLIED, OR ARISING BY OPERATION OF LAW, INCLUDING, BUT NOT LIMITED TO ANY IMPLIED WARRANTIES OF MERCHANTABILITY OR FITNESS FOR A PARTICULAR PURPOSE. THIS WARRANTY DOES NOT COVER OR PROVIDE FOR THE REIMBURSEMENT OR PAYMENT OF INCIDENTAL OR CONSEQUENTIAL DAMAGES.** Some states do not allow this exclusion or limitation of incidental or consequential damages so the above limitation or exclusion may not apply to you.

LEGAL REMEDIES: This warranty gives you specific legal rights, and you may also have other rights which vary from state to state. This warranty is void outside of the United States of America.

PROCEDURE FOR OBTAINING PERFORMANCE OF WARRANTY: If, after following the instructions in this operating guide in the Troubleshooting section, you are certain that the Product is defective, pack the Product carefully (preferably in its original packaging) and include a note describing the defect that has caused you to return it. The Product (with evidence of original purchase) should be shipped or delivered (by UPS or insured parcel post), freight prepaid, to warrantor at:

Uniden America Corporation
Parts and Service Division
8707 North By Northeast Blvd.
P.O. Box 501368
Indianapolis, IN 46250
(317) 842-2483 (Monday through Friday, 8:00 AM to 5:00 PM EST).

PATENTED UNDER ONE OR MORE OF THE FOLLOWING U.S. PATENT NUMBERS:

3,961,261	3,962,644	3,974,450	3,974,452	3,987,400
3,996,521	3,996,522	4,000,468	4,027,251	4,057,760
4,092,594	4,100,497	4,114,103	4,123,715	4,156,193
4,157,505	4,179,662	4,219,821	4,270,217	4,398,304
4,409,688	4,455,679	4,461,036	4,521,915	4,627,100
4,888,815	4,932,074	4,947,456	5,014,348	RE 31,523

DES 253,173

OTHER U.S. AND FOREIGN PATENTS PENDING

uniden[®]

Beancat[®]

©1992 Uniden America Corporation. All rights reserved.

Printed in the Philippines

UBUDO1225AZ