



MOTOROLA

USER'S GUIDE

MBP36

BABY MONITOR

USER'S GUIDE

The features described in user's guide are subject to modifications without prior notice.



Welcome...

to your new Motorola Baby Monitor!

Thank you for purchasing the MBP36. Now you can see and hear your baby sleeping in another room or you can monitor your older children in their playroom.

Please retain your original dated sales receipt for your records. For warranty service of your Motorola product, you will need to provide a copy of your dated sales receipt to confirm warranty status. Registration is not required for warranty coverage.

For product related questions, please call:

US and Canada 1-888-331-3383

UK 0845 218 0890

On the Web: www.motorola.com

This User's Guide provides you with all the information you need to get the most from your product.



Before you can use the baby monitor, we recommend you insert and fully charge the battery in the parent unit, so that it continues to work if you disconnect it from the power supply to carry it to another location. Please read the Safety Instructions on page 6 before you install the units.

Got everything?



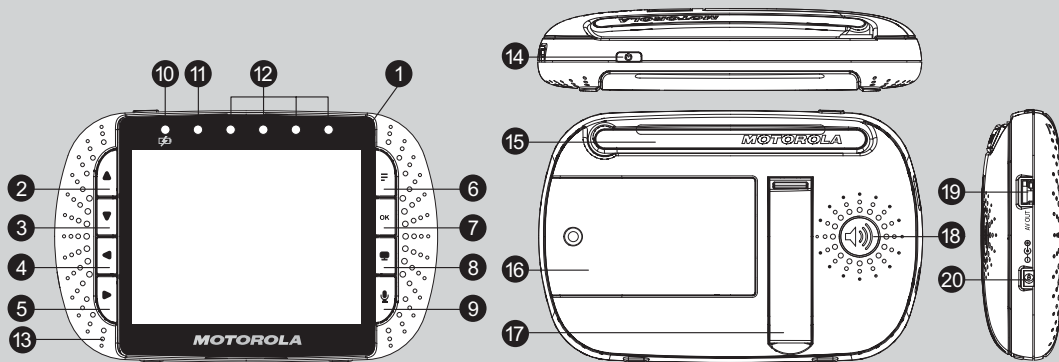





- 1 x Parent unit
- 1 x Baby unit
- 1 x Rechargeable Ni-MH battery pack for the parent unit
- 1 x Power adapter for the Parent unit
- 1 x Power adapter for the Baby unit

Overview of the Parent Unit









1. Display (LCD screen)
2. Up Key ▲
Normal Mode: Tilt Up
Menu Mode: Up
3. Down Key ▼
Normal Mode: Tilt Down
Menu Mode: Down
4. Left Key ◀
Normal Mode: Pan Left
Menu Mode: Left
5. Right Key ▶
Normal Mode: Pan Right
Menu Mode: Right
6. Menu Key ≡
Press to open the Menu options
7. OK Key OK
8. Video ON/OFF Key 
Press to turn OFF the LCD display
Press again to turn ON the LCD display
9. Talk Key 
Press and hold to speak to your baby
10. Power Adapter / Battery LED
BLUE when mains adapter power on.
RED when battery low.
11. Unit ON/OFF LED (Green)
12. Audio Level LED (Green, Orange, Red, Red)
13. Microphone
14. Power Key 
Press and Hold to turn the unit ON/OFF
15. Antenna
Lift the antenna for optimal reception
16. Battery cover
17. Stand
18. Speaker
19. USB connector
Connection to AV output
* AV Cable (Optional accessory, to be purchased separately)
20. Power Adapter connector

Parent unit menu icons

	Signal Level (5 Levels)
	Night Vision Mode (Screen changes to Black/White)
	Talk Mode
	Battery Level Control (4 Levels)
	Pan Left
	Pan Right
	Tilt Up
	Tilt Down

Parent unit menu icons (cont'd)

	Volume Level Control (8 Levels)
	Brightness Level Control (8 Levels)
	Lullaby Control (5 Song Selections)
	Zoom Level Control (1X, 2X)
	Alarm Setting (6h, 4h, 2h, OFF)
	Cam Control (scan, view, add, del)
	Temperature Reading (HH °C / °F or LL °C / °F) Icon & readings turn RED > 29°C / 84°F, and reading display HH °C / °F > 36°C / 97 °F) Icon & readings turn RED < 14°C / 57°F, and reading display LL °C / °F < 1°C / 34 °F)

Overview of Your Baby Unit

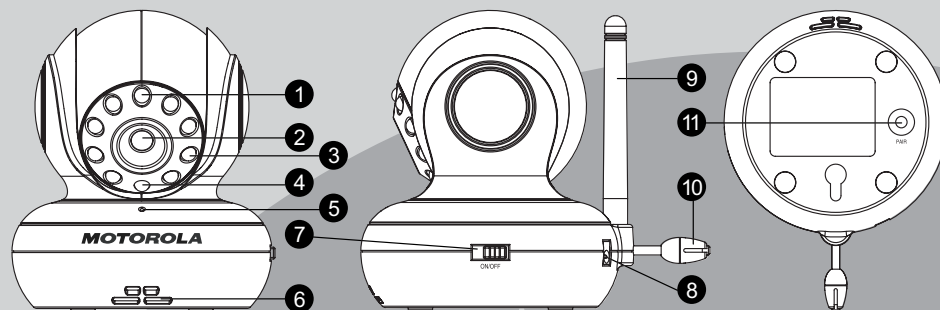

- | | |
|-------------------------------------|----------------------------|
| 1. Photo Sensor (Night Vision Mode) | 6. Speaker |
| 2. Camera Lens | 7. ON/OFF Switch |
| 3. Infrared LEDs | 8. Power Adapter Connector |
| 4. Power LED | 9. Antenna |
| 5. Microphone | 10. Temperature Sensor |
| | 11. Pair Key |

Important guidelines for installing your Baby Monitor

- To use your Video Monitor Baby and Parent Unit together, you must be able to establish a radio link between them, and the range will be affected by environmental conditions.
- Any large metal object, like a refrigerator, a mirror, a filing cabinet, metallic doors or reinforced concrete between the Baby and Parent Unit may block the radio signal.
- The signal strength may also be reduced by other solid structures, like walls, or by radio or electrical equipment, such as TVs, computers, cordless or mobile phones, fluorescent lights or dimmer switches.
- Use of other 2.4GHz products, such as wireless networks (WiFi routers), Bluetooth® systems, or microwave ovens, may cause interference with this product, so keep the baby monitor away at **least 5ft (1m)** from these types of products, or turn them off if they appear to be causing interference.
- If the signal is weak, try moving the Parent and/or the Baby Unit to different positions in the rooms.



Table of contents

1. Safety Instructions	6
2. Getting Started	8
2.1 Baby Unit Power Supply	8
2.2 Parent Unit Battery Installation	8
2.3 Parent Unit Power Supply	9
2.4 Registration (Pairing).....	10
2.5 View Video Through TV.....	10
3. Using the Baby Monitor MBP36	11
3.1 Setting up	11
3.2 Pan and Tilt	11
3.3 Night Vision Mode	11
3.4 Talk Mode.....	11
3.5 Video ON/OFF	11
3.6 Temperature Display (HH °C / °F or LL °C / °F).....	11
4. MBP36 Parent Unit Menu Options	12
4.1 Volume	12
4.2 Brightness.....	12
4.3 Lullaby	12
4.4 Zoom	12
4.5 Alarm	13
4.6 Camera Control	13
4.6.1 Add (pair) a camera	13
4.6.2 View a camera	13
4.6.3 Delete a camera	14
4.6.4 Scan camera	14
4.7 Temperature	14
5. Disposal of The Device (environment).....	15
6. Cleaning	16
7. Help.....	17
8. General Information	19

1. Safety Instructions



WARNING:

STRANGULATION HAZARD - Keep the adapter cord out of baby's reach.

NEVER place camera or cords within the cot / crib.

Secure the cord some distance away from baby's reach.

Never use extension cords with AC Adapters. Only use the AC Adapters provided.

CAMERA SET UP & USE:

- Determine a location for the CAMERA that will provide the best view of your baby in his cot / crib.
- Place the CAMERA on a flat surface, such as a dresser, bureau, or shelf.
- NEVER place camera or cords within cot / crib.
- Secure the cord to the wall to keep cord away from the baby's reach.

WARNING

This baby monitor is compliant with all relevant standards regarding electromagnetic fields and is, when handled as described in the User's Guide, safe to use. Therefore, always read the instructions in this User's Guide carefully before using the device.

- Adult assembly is required. Keep small parts away from children when assembling.
- This product is not a toy. Do not allow children to play with it.
- This baby monitor is not a substitute for responsible adult supervision.
- Keep this user's guide for future reference.
- Do not place the baby unit or cables in the cot / crib or within reach of the baby (the unit should be at least 3 feet away).
- Keep the cords out of reach of children.
- Do not cover the baby monitor with a towel or blanket.



- Never use extension cords with power adapters. Only use the power adapters provided.
- Test this monitor and all its functions so that you are familiar with it prior to actual use.
- Do not use the baby monitor near water.
- Do not install the baby monitor near a heat source.
- Only use the chargers and power adapters provided. Do not use other chargers or power adapters as this may damage the device and battery pack.
- Only insert a battery pack of the same type.
- Do not touch the plug contacts with sharp or metal objects.

CAUTION

*Risk of explosion if battery is replaced by an incorrect type.
Dispose of used batteries according to the instructions.*

2. Getting Started

2.1 Baby Unit Power Supply

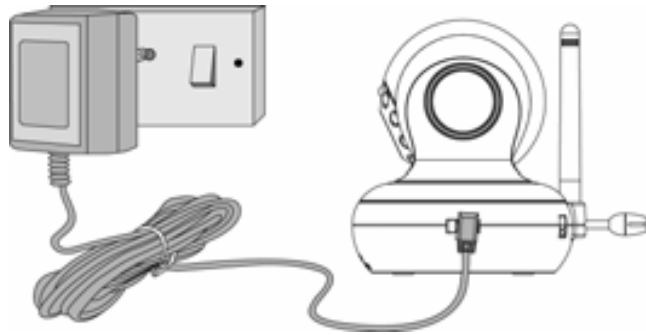

1. Connect the small plug of the power adapter to the baby unit and the other end to the electrical outlet.

NOTE

Only use the enclosed power adapter (5.9V DC / 1000mA).

2. Slide the ON/OFF switch to the ON position. The power LED will light up in green.
3. Slide the ON/OFF switch to the OFF position to turn the Baby Unit off.

2.2 Parent Unit Battery Installation

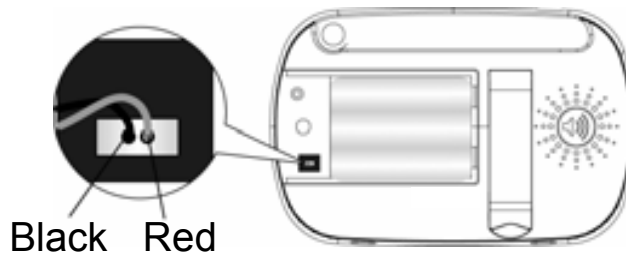

1. Insert the wire tab of the rechargeable battery pack into the contact slot as shown above and fit the battery pack into the compartment.

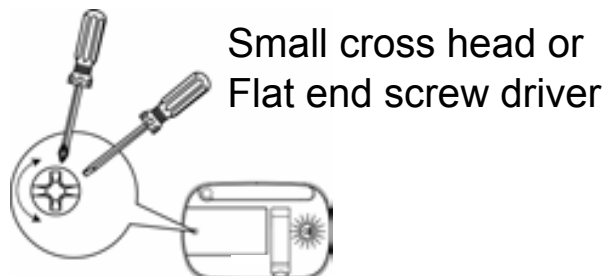

2. Replace the battery cover over the compartment and gently tighten the screw in a clockwise direction using a Small cross head or Flat end screw drivers.



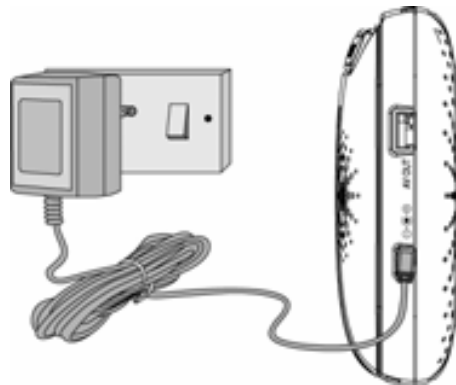

2.3 Parent Unit Power Supply



IMPORTANT

Installing the rechargeable battery pack and charging it fully before use is recommended. This will allow the unit to operate on battery in the event of a power failure.

1. Connect the small plug of the power adapter to the parent unit and the other end to the electrical outlet. Only use the enclosed power adapter (6V DC/500mA).
2. Press and hold the  POWER ON/OFF button for 1 second to turn ON the parent unit.
3. Once the baby and parent units are switched on, the display on the parent unit will show the video captured by the baby unit.
4. If there is no connection or you are out of range, the video display will go off and the words **No Signal** will be shown on the LCD display, and the unit will beep every 5 seconds. Move the parent unit closer to the baby unit until the link is re-established.
5. Press and hold the  POWER ON/OFF button, until the progress bar finishes scrolling, to turn OFF the parent unit.

NOTE

The battery icon  turns RED to indicate that the battery is low, and it gives a beep every 16 seconds. The battery needs to be recharged. The battery pack takes about 16 hours to charge fully.

When charging

1. During power OFF, when adapter is plugged in, a adapter logo will display on screen and then a flashing battery logo will display for 45 sec. The Blue LED at top left corner light up indicates adapter is plugged in.

2. During power ON, when adapter is plugged in, the battery icon on screen's top right corner will show that the battery is charging. The Blue LED at the top left corner light up indicates adapter is plugged in.

2.4 Registration (Pairing)

The Baby monitor is pre-registered to your Parent Unit. You do not need to register it again unless the Baby Unit loses its link with the Parent Unit. To re-register your Baby Unit, or register a new Baby Unit, follow the procedure below:

1. Press the **≡** button of the parent unit and the menu bar will pop up.
2. Press the **◀ LEFT** button or **▶ RIGHT** button until **⊙** is highlighted, and the **del/add/view/scan** menu will pop up.
3. Press the **▲ UP** button or **▼ DOWN** button to select **ADD**, and press the **OK** button to confirm.
4. **CAM 1 / CAM 2 / CAM 3 / CAM 4** will pop up, press the **▲ UP** button or **▼ DOWN** button to select the desired CAM and press the **OK** button to start searching for a camera unit. The green audio level LED will flash rapidly while searching.
5. Press the **OK** button to confirm.
6. Press and hold the **PAIR** button underneath the baby unit until the parent unit finds the camera, beeps and the video from the camera appears.

NOTE

If a particular Baby Unit was registered previously, registering this current Baby Unit again will overwrite the old registration.

2.5 View Video Through TV

Connect a suitable AV cable into the AV OUT socket on the side of the Parent Unit and into the AV input of the TV. Scroll through the AV inputs on the TV menu until the Baby monitor picture is visible.

AV cable is an optional accessory, which is to be purchased separately.

NOTE

The Monitor's power button must be turned ON and CAM pre-selected before connecting the AV cable. Once the AV cable is connected, the Monitor's controls cannot be activated.



3. Using the Baby Monitor MBP36

3.1 Setting up

- Place the baby unit in a convenient location (e.g. on a table) and point the camera lens towards the area you want to monitor.
- Adjust the baby unit's head angle by rotating the camera up, down, left and right until you are satisfied with the image in the parent unit.

NOTE

Do not place the baby unit within baby's reach! If there is interference with the picture or sound, try moving the units to different locations, and ensure they are not close to other electrical equipment.

3.2 Pan and Tilt

The camera can be remotely controlled from the parent unit.

1. Press the ▲ UP button or ▼ DOWN button to tilt upward or downward.
2. Press the ◀ LEFT button or ▶ RIGHT button to pan left or right.

3.3 Night Vision Mode

The baby unit has 8 high-intensity infrared LEDs for picking up clear images in the dark. When the built-in photo sensor detects a low level of ambient light, the LEDs will automatically activate and the screen on the parent unit will display in black and white. The ☾ icon will be displayed on the screen.

3.4 Talk Mode

Press and hold the 🗣️ TALK button on the parent unit to talk to your baby through the baby unit's loudspeaker. The 🗣️ icon will be displayed at the top of the LCD screen.

3.5 Video ON/OFF

Press 📺 VIDEO ON/OFF key to turn the LCD display on or off, but will still leave the audio monitor on.

3.6 Temperature Display (HH °C / °F or LL °C / °F)

The temperature reading from the temperature sensor at the back of the Baby Unit will be displayed at the top of the LCD screen. The readings will turn RED if the temperature goes above 29°C / 84°F or below 14°C / 57°F. The reading will change to HH °C / °F if the temperature goes above 36°C / 97°F. The reading will change to LL °C / °F if the temperature goes below 1°C / 34°F.

4. MBP36 Parent Unit Menu Options

4.1 Volume

1. Press the **≡** button and the menu bar will pop up.
2. Press the **◀** LEFT button or **▶** button until **🔊** is highlighted.
3. Press the **▲** UP button or **▼** DOWN button to select the desired volume level from level 1 ~ 8. (The default volume level setting is level 4.)

4.2 Brightness

1. Press the **≡** button and the menu bar will pop up.
2. Press the **◀** LEFT button or **▶** button until **💡** is highlighted.
3. Press the **▲** UP button or **▼** DOWN button to select the desired brightness level from level 1 ~ 8. (The default brightness level setting is level 4.)

4.3 Lullaby

1. Press the **≡** button and the menu bar will pop up.
2. Press the **◀** LEFT button or **▶** button until **🎵** is highlighted.
3. Press the **▲** UP button or **▼** DOWN button to select the desired song from the 5 lullabies available, or the cycle option to play all 5 songs in turn. If an individual song is selected it will only play once and then stop. (The default setting is lullaby OFF)
4. Press **OK** on the selected lullabies to select the desired song sound level.

4.4 Zoom

1. Press the **≡** button and the menu bar will pop up.
2. Press the **◀** LEFT button or **▶** button until **🔍** is highlighted.
3. Press the **▲** UP button or **▼** DOWN button to select the 1X or 2X Zoom. (The default setting is 1X.)



4.5 Alarm

1. Press the **≡** button and the menu bar will pop up.
2. Press the **◀** LEFT button or **▶** RIGHT button until **🔔** is highlighted.
3. Press the **▲** UP button or **▼** DOWN button to select the alarm time (6h, 4h, 2h). (The default setting is Alarm OFF.)

If an alarm time is selected, the parent unit will beep for about 45 seconds after every 6, 4 or 2 hour period, and the alarm icon will flash red.

4.6 Camera Control

4.6.1 Add (pair) a camera

1. Press the **≡** button and the menu bar will pop up.
2. Press the **◀** LEFT button or **▶** RIGHT button until **📷** is highlighted, and the **del/add/view/scan** menu will pop up.
3. Press the **▲** UP button or **▼** DOWN button to select **ADD**, and press the **OK** button to confirm.
4. **CAM 1 / CAM 2 / CAM 3 / CAM 4** will pop up, press the **▲** UP button or **▼** DOWN button to select the desired CAM, and press the **OK** button to start searching for a camera unit. The green audio level LED will flash rapidly while searching.
5. Press and hold the PAIR button underneath the baby unit until the parent unit finds the camera, beeps and the picture from the camera appears.

NOTE

A camera can only be registered to one parent unit at any one time.

4.6.2 View a camera

1. Press the **≡** button and the menu bar will pop up.
2. Press the **◀** LEFT button or **▶** RIGHT button until **📷** is highlighted and the **del/add/view/scan** menu pops up.
3. Press the **▲** UP button or **▼** DOWN button to select **VIEW**, and press the **OK** button to confirm.
4. **CAM 1 / CAM 2 / CAM 3 / CAM 4** will pop up, press the **▲** UP button or **▼** DOWN button to select desired CAM, and press the **OK** button to view the picture from that camera.

TIP

*Quick Method to View Cameras instead of entering into the menu bar.
Directly press **OK** repeatedly to select **CAM 1**, **CAM 2**, **CAM 3**, **CAM 4**, **SCAN**.*

4.6.3 Delete a camera

1. Press the **≡** button and the menu bar will pop up.
2. Press the **◀** LEFT button or **▶** RIGHT button until **☉** is highlighted, and the **del/add/view/scan** menu will pop up.
3. Press the **▲** UP button or **▼** DOWN button to select **DEL**, and press the **OK** button to confirm.
4. **CAM 1/CAM 2/CAM 3/CAM 4** will pop up, press the **▲** UP button or **▼** DOWN button to select the desired CAM, and press the **OK** button to delete that registration.

4.6.4 Scan camera

1. Press the **≡** button and the menu bar will pop up.
2. Press the **◀** LEFT button or **▶** RIGHT button until **☉** is highlighted, and the **del/add/view/scan** menu will pop up.
3. Press the **▲** UP button or **▼** DOWN button to select **SCAN**, and press the **OK** button to confirm.
4. The screen will then display images from different registered cameras in a loop of **CAM 1/CAM 2/CAM 3/CAM 4**, changing about every 12 seconds.

TIP

*Quick Method to View Cameras instead of entering into the menu bar.
Directly press **OK** repeatedly to select **CAM 1**, **CAM 2**, **CAM 3**, **CAM 4**, **SCAN**.*

4.7 Temperature

1. Press the **≡** button and the menu bar will pop up.
2. Press the **◀** LEFT button or **▶** RIGHT button until **†** is highlighted.
3. Press the **▲** UP button or **▼** DOWN button to select **°C** or **°F**.



5. Disposal of The Device (environment)

At the end of the product lifecycle, you should not dispose of this product with normal household waste. Take this product to a collection point for the recycling of electrical and electronic equipment. The symbol on the product, user's guide and/or box indicates this.

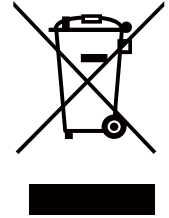

Some of the product materials can be reused if you take them to a recycling point. By reusing some parts or raw materials from used products you make an important contribution to the protection of the environment.

Please contact your local authorities in case you need more information on the collection points in your area.

Dispose of the battery pack in an environmentally-friendly manner according to your local regulations.

6. Cleaning

Clean the MBP36 with a slightly damp cloth or with an anti-static cloth. Never use cleaning agents or abrasive solvents.

Cleaning and care



- Do not clean any part of the product with thinners or other solvents and chemicals — this may cause permanent damage to the product which is not covered by the warranty.
- Keep your MBP36 away from hot, humid areas or strong sunlight, and don't let it get wet.
- Every effort has been made to ensure high standards of reliability for your MBP36. However, if something does go wrong, please do not try to repair it yourself — contact Customer Service for assistance.



7. Help

Display

No display

- Try recharging or replacing the battery pack.
- Reset the units. Disconnect the battery pack of the parent unit and unplug both the units' electrical power, then plug them back in.
- Is the unit turned on?
Press and hold the ON/OFF key  on the parent unit to turn it ON.
- Is the correct camera selected?
Change the camera number, if necessary.
- Is the video display turned on?
Press the VIDEO ON/OFF key  to turn it on.
- When operating using batteries, only the Display will go blank after 2 minutes to save power.
The unit is still active and will give you audio alerts. You can reactivate the screen by pressing any key.

Registration

If the Baby Unit has lost its link with the Parent Unit

- Try recharging or replacing the battery pack.
- If the Baby Unit is too far away it may be going out of range, so move the Baby Unit closer to the Parent Unit.
- Reset the units by disconnecting them from the battery and electrical power. Wait about 15 seconds before reconnecting. Allow up to one minute for the Baby Unit and the Parent Unit to synchronize.
- See 2.4 Registration (Pairing), if there is a need to re-register the units.

Interference

Noise interference on your parent unit

- Your baby and parent units may be too close. Move them farther apart.
- Make sure there is at least 3 to 6 feet between the 2 units to avoid audio feedback.
- If the baby unit is too far away it may be out of range, so move the baby unit closer to the parent unit.
- Make sure the baby and parent units are not near other electrical equipment, such as a television, computer or cordless/mobile telephone.
- Use of other 2.4GHz products, such as wireless networks (WiFi routers), Bluetooth® systems, or microwave ovens, may cause interference with this product, so keep the baby monitor away **at least 5ft (1m)** from these types of products, or turn them off if they appear to be causing interference.
- If the signal is weak, try moving the Parent and/or Baby Unit to different positions in the rooms.

8. General Information

If your product is not working properly....

1. Read this User's Guide or the Quick Start Guide.
2. Visit our website:
www.motorola.com
3. Contact Customer Service:
US and Canada 1-888-331-3383
UK 0845 218 0890

To order a replacement battery pack, contact customer service or visit our website.

Consumer Products and Accessories Limited Warranty ("Warranty")

Thank you for purchasing this Motorola branded product manufactured under license by Binatone Electronics International LTD ("BINATONE").

What Does this Warranty Cover?

Subject to the exclusions contained below, BINATONE warrants that this Motorola branded product ("Product") or certified accessory ("Accessory") sold for use with this product that it manufactured to be free from defects in materials and workmanship under normal consumer usage for the period outlined below. This Warranty is your exclusive warranty and is not transferable.

Who is covered?

This Warranty extends only to the first consumer purchaser, and is not transferable.

What will BINATONE do?

BINATONE or its authorized distributor at its option and within a commercially reasonable time, will at no charge repair or replace any Products or Accessories that does not conform to this Warranty. We may use functionally equivalent reconditioned/ refurbished/ pre-owned or new Products, Accessories or parts.

What Other Limitations Are There?

ANY IMPLIED WARRANTIES, INCLUDING WITHOUT LIMITATION THE IMPLIED WARRANTIES OF MERCHANTABILITY AND FITNESS FOR A PARTICULAR PURPOSE, SHALL BE LIMITED TO THE DURATION OF THIS LIMITED WARRANTY, OTHERWISE THE REPAIR OR REPLACEMENT PROVIDED UNDER THIS EXPRESS LIMITED WARRANTY IS THE EXCLUSIVE REMEDY OF THE CONSUMER, AND IS PROVIDED IN LIEU OF ALL OTHER WARRANTIES, EXPRESS OF IMPLIED. IN NO EVENT SHALL MOTOROLA OR BINATONE BE LIABLE, WHETHER IN CONTRACT OR TORT (INCLUDING NEGLIGENCE) FOR DAMAGES IN EXCESS OF THE PURCHASE PRICE OF THE PRODUCT OR ACCESSORY, OR FOR ANY INDIRECT, INCIDENTAL, SPECIAL OR CONSEQUENTIAL DAMAGES OF ANY KIND, OR LOSS OF REVENUE OR PROFITS, LOSS OF BUSINESS, LOSS OF INFORMATION OR OTHER FINANCIAL LOSS ARISING OUT OF OR IN CONNECTION WITH THE ABILITY OR INABILITY TO USE THE PRODUCTS OR ACCESSORIES TO THE FULL EXTENT THESE DAMAGES MAY BE DISCLAIMED BY LAW.

Some jurisdictions do not allow the limitation or exclusion of incidental or consequential damages, or limitation on the length of an implied warranty, so the above limitations or exclusions may not apply to you. This Warranty gives you specific legal rights, and you may also have other rights that vary from one jurisdiction to another.



Products Covered	Length of Coverage
Consumer Products	One (1) year from the date of the products original purchase by the first consumer purchaser of the product.
Consumer Accessories	Ninety (90) days from the date of the accessories original purchase by the first consumer purchaser of the product.
Consumer Products and Accessories that are Repaired or Replaced	The balance of the original warranty or for Ninety (90) days from the date returned to the consumer, whichever is longer.

Exclusions

Normal Wear and Tear. Periodic maintenance, repair and replacement of parts due to normal wear and tear are excluded from coverage.

Batteries. Only batteries whose fully charged capacity falls below 80% of their rated capacity and batteries that leak are covered by this Warranty.

Abuse & Misuse. Defects or damage that result from: (a) improper operation, storage, misuse or abuse, accident or neglect, such as physical damage (cracks, scratches, etc.) to the surface of the product resulting from misuse; (b) contact with liquid, water, rain, extreme humidity or heavy perspiration, sand, dirt or the like, extreme heat, or food; (c) use of the Products or Accessories for commercial purposes or subjecting the Product or Accessory to abnormal usage or conditions; or (d) other acts which are not the fault of MOTOROLA or BINATONE., are excluded from coverage.

Use of Non-Motorola branded Products and Accessories. Defects or damage that result from the use of Non-Motorola branded or certified Products or Accessories or other peripheral equipment are excluded from coverage.

Unauthorized Service or Modification. Defects or damages resulting from service, testing, adjustment, installation, maintenance, alteration, or modification in any way by someone other than MOTOROLA, BINATONE or its authorized service centers, are excluded from coverage.

Altered Products. Products or Accessories with (a) serial numbers or date tags that have been removed, altered or obliterated; (b) broken seals or that show evidence of tampering; (c) mismatched board serial numbers; or (d) nonconforming or non-Motorola branded housings, or parts, are excluded from coverage.

Communication Services. Defects, damages, or the failure of Products or Accessories due to any communication service or signal you may subscribe to or use with the Products or Accessories is excluded from coverage.

How to Obtain Warranty Service or Other Information?

To obtain service or information, please call:

US and Canada 1-888-331-3383

UK 0845 218 0890

You will receive instructions on how to ship the Products or Accessories at your expense and risk, to a BINATONE Authorized Repair Center.

To obtain service, you must include: (a) the Product or Accessory; (b) the original proof of purchase (receipt) which includes the date, place and seller of the Product; (c) if a warranty card was included in your box, a completed warranty card showing the serial number of the Product; (d) a written description of the problem; and, most importantly; (e) your address and telephone number.

These terms and conditions constitute the complete warranty agreement between you and BINATONE. regarding the Products or Accessories purchased by you, and supersede any prior agreement or representations, including representations made in any literature publications or promotional materials issued by BINATONE. or representations made by any agent employee or staff of BINATONE, that may have been made in connection with the said purchase.

FCC and IC regulations

FCC Part 15

NOTE: This equipment has been tested and found to comply with the limits for a Class B digital device, pursuant to Part 15 of the Federal Communications Commission (FCC) rules. These limits are designed to provide reasonable protection against harmful interference in a residential installation. This equipment generates, uses and can radiate radio frequency energy and, if not installed and used in accordance with the instructions, may cause harmful interference to radio communications. However, there is no guarantee that interference will not occur in a particular installation. If this equipment does cause harmful interference to radio or television reception, which can be determined by turning the equipment off and on, the user is encouraged to try to correct the interference by one or more of the following measures:

- Reorient or relocate the receiving antenna.
- Increase the separation between the equipment and receiver.
- Connect the equipment into an outlet on a circuit different from that to which the receiver is connected.
- Consult the dealer or an experienced radio/TV technician for help.

Changes or modifications to this equipment not expressly approved by the party responsible for compliance could void the user's authority to operate the equipment.

This device complies with Part 15 of the FCC rules. Operation is subject to the following two conditions: (1) this device may not cause harmful interference, and (2) this device must accept any interference received, including interference that may cause undesired operation. Privacy of communications may not be ensured when using this device.

To ensure safety of users, the FCC has established criteria for the amount of radio frequency energy that can be safely absorbed by a user or bystander according to the intended usage of the product. This product has been tested and found to comply with the FCC criteria. The Baby unit shall be installed and used such that parts of the user's body other than the hands are maintained at a distance of approximately 20 cm (8 inches) or more.

This Class B digital apparatus complies with Canadian ICES-003.

WARNING

Changes or modifications, to this equipment not expressly approved by the party responsible for compliance could void the user's authority to operate the equipment.

Industry Canada

This device complies with Industry Canada licence-exempt RSS standard(s): Operation is subject to the following Two conditions:(1) this device may not cause interference, and (2) this device must accept any interference, including interference that may cause undesired operation of the device.

The term "IC: " before the certification/registration number only signifies that the Industry Canada technical specifications were met. This product meets the applicable Industry Canada technical specifications.



Technical Specifications

Baby unit (Model: MBP36BU)

Frequency	2.4GHz to 2.48GHz
Image sensor	colour / color CMOS 30M Pixels
Lens	f 2.5mm, F 2.8
IR LED	8 pcs
Power	Adapter: SCE0591000P; Input: 100-240V, 50/60Hz 300mA; Output: 5.9V, 1000mA OR Adapter: BLJ5W059100P; Input: 100-240V, 50/60Hz 150mA; Output: 5.9V, 1000mA WARNING <i>Use only with provided power supply.</i>
FCC ID	VLJ – MBP36BU
IC ID	4522A– MBP36BU



Parent unit (Model: MBP36PU)

Frequency	2.4GHz to 2.48GHz
Display	3.5" TFT LCD
Display colours / colors	16.7M colour / color LCD
Brightness control	8 steps
Volume control	8 steps
Power	Adapter: SCB0600500P; Input: 100-240V, 50/60Hz 300mA; Output: 6.0V, 500mA OR Adapter: BLJ5W060050P; Input: 100-240V, 50/60Hz 150mA; Output: 6.0V, 500mA WARNING <i>Use only with provided power supply.</i> OR Battery: Model - TFL3X44AAA900, NI-MH AAA 3 x 1.2V 900mAh rechargeable battery pack WARNING <i>Do not use non-rechargeable batteries for the Parent Unit. Risk of explosion if battery is replaced by an incorrect type. Dispose of used batteries according to the instructions.</i>
FCC ID	VLJ – MBP36PU
IC ID	4522A– MBP36PU

BINATONE TELECOM PLC
1 Apsley Way London NW2 7HF, United Kingdom.
Tel: +44(0) 20 8955 2700 Fax: +44(0) 20 8344 8877
e-mail: binatoneuk@binatonetelecom.co.uk



EC Declaration of Conformity

We the manufacturer / Importer : Binatone Telecom Plc
1 Apsley Way London
NW2 7HF, United Kingdom.

Declare under our sole responsibility that the following product

Type of equipment: Digital Baby Monitor
Model Name: MBP 36

Country of Origin: China
Brand: Motorola

complies with the essential protection requirements of R&TTE Directive 1999/5/EC on the approximation of the laws of the Member States relating to **Radio Spectrum Matters**, the Council Directive 2004/108/EC on the approximation of the laws of the Member States relating to **electromagnetic compatibility (EMC)** and the European Community Directive 2006/95/EC relating to **Electrical Safety**.

Assessment of compliance of the product with the requirements relating to the essential requirements according to Article 3 R&TTE was based on Annex III of the Directive 1999/5/EC and the following standard:

Radio Spectrum: EN300328 V1.7.1 (2006-10)
EMC: EN301489-17 V1.3.2 (2008-04)
EN301489-1 V1.8.1 (2008-04)
Electrical Safety: EN60950-1:2006+A11:2009+A1:2010

The product is labelled with the European Approval Marking CE as show. Any Unauthorized modification of the product voids this Declaration.



Manufacturer / Importer
(Signature of authorized person)

A handwritten signature in black ink, appearing to read "Paul Tsui".



London, 10 Apr 11

Signature: (Paul Tsui/ Product Operation
Director)

Place & Date



MOTOROLA

Manufactured, distributed or sold by Binatone Electronics International LTD., official licensee for this product. MOTOROLA and the Stylized M Logo, are trademarks or registered trademarks of Motorola Trademark Holdings, LLC. and are used under license. All other trademarks are the property of their respective owners.

© 2011 Motorola Mobility, Inc. All rights reserved.



Version 2.0

Printed in China

