



## INSTRUCTION MANUAL

# VHF AIR BAND TRANSCEIVER IC-A110

This device complies with Part 15 of the FCC Rules. Operation is subject to the condition that this device does not cause harmful interference.

Icom Inc.



---

## FOREWORD

---

**READ ALL INSTRUCTIONS** carefully and completely before using the transceiver.

**SAVE THIS INSTRUCTION MANUAL** — This instruction manual contains important operating instructions for the IC-A110.

---

## EXPLICIT DEFINITIONS

---

The explicit definitions below apply to this instruction manual.

| WORD              | DEFINITION  |
|-------------------|---|
| <b>⚠ WARNING!</b> | Personal injury, fire hazard or electric shock may occur.                               |
| <b>CAUTION</b>    | Equipment damage may occur.   |
| <b>NOTE</b>       | If disregarded, inconvenience only. No risk of personal injury, fire or electric shock. |

### ***For Canada:***

This device complies with RSS-310 of Industry Canada. Operation is subject to the condition that this device does not cause harmful interference.

Cet appareil est conforme au CNR-310 d'Industrie Canada. Son exploitation est autorisée sous réserve que l'appareil ne cause pas de brouillage préjudiciable.

---

## PRECAUTIONS

---

**⚠ WARNING! NEVER** operate the transceiver with a headset or other audio accessories at high volume levels. Hearing experts advise against continuous high volume operation. If you experience a ringing in your ears, reduce the volume level or discontinue use.

**⚠ WARNING! NEVER** connect the transceiver to an AC outlet or to a power source of more than 27.5 V DC, or use reverse polarity. This could cause a fire or damage the transceiver.

**CAUTION: NEVER** connect the transceiver to a power source that is DC fused at more than 5 A. Accidental reverse connection will be protected by this fuse, higher fuse values will not give any protection against such accidents and the transceiver will be ruined.

**DO NOT** operate the transceiver near unshielded electrical blasting caps or in an explosive atmosphere.

Always place unit in a secure place to avoid inadvertent use by children.

**DO NOT** push the PTT switch when you don't actually desire to transmit.

---

# TABLE OF CONTENTS

---

|  |              |
|--|--------------|
| FOREWORD .....                                     | i            |
| EXPLICIT DEFINITIONS .....                         | i            |
| PRECAUTIONS .....                                  | i            |
| TABLE OF CONTENTS .....                            | ii           |
| <b>1 PANEL DESCRIPTION .....</b>                   | <b>1-3</b>   |
| ■ Panel description .....                          | 1-2          |
| ■ Function display .....                           | 3            |
| <b>2 BASIC OPERATION .....</b>                     | <b>4-5</b>   |
| ■ Power ON .....                                   | 4            |
| ■ Channel selection .....                          | 4            |
| ■ Squelch function .....                           | 5            |
| ■ Sidetone function .....                          | 5            |
| ■ LCD backlight control .....                      | 5            |
| ■ Dial select function .....                       | 5            |
| <b>3 SCAN OPERATION .....</b>                      | <b>6-7</b>   |
| ■ Scan operation .....                             | 6            |
| ■ ON-Hook scan .....                               | 7            |
| ■ Dualwatch .....                                  | 7            |
| <b>4 MEMORY PROGRAMMING .....</b>                  | <b>8-9</b>   |
| ■ Programming a memory channel .....               | 8            |
| ■ Memory names .....                               | 9            |
| <b>5 OTHER FUNCTIONS .....</b>                     | <b>10-11</b> |
| ■ Initial Set mode .....                           | 10           |
| ■ Cloning .....                                    | 11           |
| <b>6 CONNECTION AND INSTALLATION .....</b>         | <b>12-13</b> |
| ■ Rear panel and connections .....                 | 12           |
| ■ Mounting .....                                   | 13           |
| ■ Supplied accessories .....                       | 13           |
| <b>7 SPECIFICATIONS .....</b>                      | <b>14-15</b> |
| <b>8 OPTIONS .....</b>                             | <b>16-17</b> |
| ■ OPC-871 Headset adapter .....                    | 16           |
| ■ Other options .....                              | 17           |
| <b>9 FOR CLASS B UNINTENTIONAL RADIATORS .....</b> | <b>18</b>    |
| <b>10 SAFETY TRAINING INFORMATION .....</b>        | <b>19-20</b> |

---

**DO NOT** use or place the transceiver in areas with temperatures below  $-30^{\circ}\text{C}$  ( $-22^{\circ}\text{F}$ ) or above  $+60^{\circ}\text{C}$  ( $+140^{\circ}\text{F}$ ), or in areas subject to direct sunlight, such as the dashboard.

**DO NOT** place the transceiver in excessively dusty environments.

**DO NOT** place the transceiver against walls. This will obstruct heat dissipation.

**DO NOT** use harsh solvents such as benzine or alcohol when cleaning, as they will damage the transceiver surfaces.

**BE CAREFUL!** The transceiver will become hot when operating continuously for long periods of time.

**FCC caution:** *Changes or modifications to this transceiver, not expressly approved by Icom Inc., could void your authority to operate this transceiver under FCC regulations.*

Icom, Icom Inc. and the Icom logo are registered trademarks of Icom Incorporated (Japan) in Japan, the United States, the United Kingdom, Germany, France, Spain, Russia and/or other countries.

# 1

## PANEL DESCRIPTION

### ■ Panel description

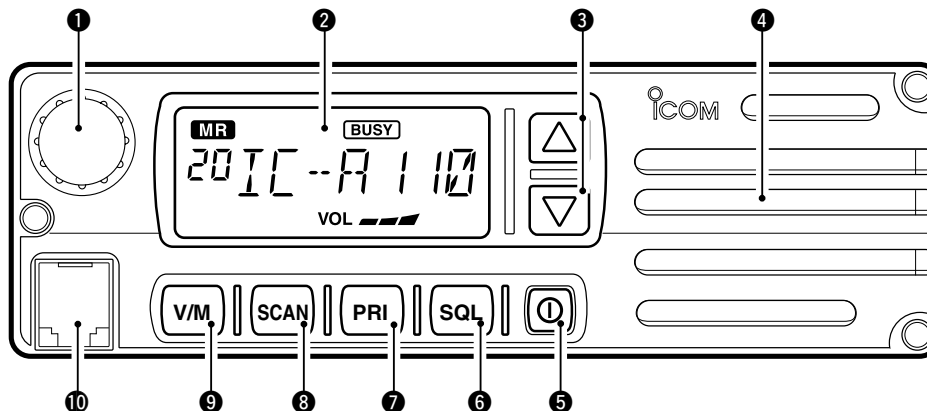

#### ① TUNING [DIAL] [TS](DIAL)

- ➔ Changes the operating frequency; memory channel in the Memory mode; set mode contents in the Set mode, etc.
- ➔ Push to toggle the dimmer control OFF, Low or High.
- ➔ Hold down for 1 second to select the Tuning Step [TS]; 1 MHz or 10 kHz are selectable. (p. 5)

#### ② FUNCTION DISPLAY (p. 3)

Displays the operating frequency, memory channel name, etc.

#### ③ VOLUME UP [▲] DOWN [▼] KEY

Adjusts the audio output level.

#### ④ LOUD SPEAKER

Front mounted loud speaker.

#### ⑤ POWER SWITCH [POWER]

Hold down 0.5 seconds to turn the power ON or OFF.

- At Power ON, the Initial Set mode (p. 10) or the Cloning mode (p. 11) can optionally be selected.

**6 SQL SWITCH [SQL]**

- Push to turn ON the squelch adjust mode. (p. 5)
- Hold down this switch for 1 second to turn the both internal and external speaker output ON or OFF. (p. 4)

**7 PRIORITY SWITCH [PRI]**

Push to select the priority channel. (p. 11)

- “Pr” appears on the display.

**8 SCAN SWITCH [SCAN]**

- Starts and stops the scan function:
  - VFO mode: VFO scan function. (p. 6)
  - Memory mode: Memory channel scan function. (p. 6)
- Hold down this switch for 5 seconds to set the displayed channel as a memory lockout channel. (p. 8)
  - “LOCK OUT” appears on the display.

**9 VFO/MEMORY SWITCH [V/M] [MW](V/M)**

- Push to toggle between the VFO mode and the Memory mode. (p. 4)
  - “**M**” and memory channel number appear when the Memory mode is selected.
  - The transceiver has 99 memory channels.
- When the VFO mode is selected;
  - Hold down this switch for 5 seconds to enter the VFO frequency into the memory channel. (p. 8)
- When the Memory mode is selected;
  - Hold down this switch for 5 seconds to turn ON the “Memory name write mode.” (p. 9)

**10 MICROPHONE CONNECTOR**

Connects to the supplied microphone or optional. **NEVER** connect other microphones. The pin assignments may be different and the transceiver may be damaged.

**MICROPHONE**

The supplied microphone has a PTT switch and a cradle. The following functions are available when the microphone is taken off the hook or put back on the hook:

- Automatic scan starts when the microphone is put ON Hook. (p. 7)
- Automatic scan stops when the microphone is taken OFF Hook. (p. 7)

**NOTE:** Optional functions vary with transceiver version. In this manual, optional functions are indicated by an “OPTION” Icon. Please contact your dealer for details.

# 1 PANEL DESCRIPTION

## ■ Function display

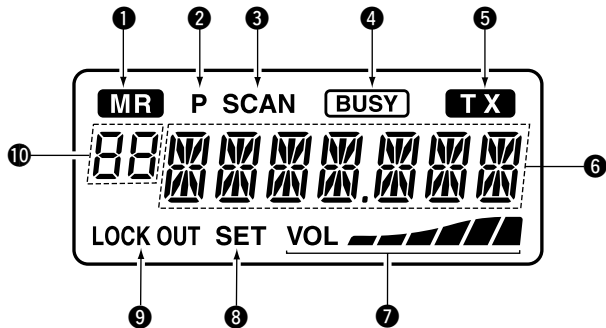

- 1 MEMORY MODE INDICATOR** (p. 4)  
Appears when the Memory mode is selected.
- 2 DUALWATCH INDICATOR** (p. 7)  
Appears when the dualwatch function is activated.
- 3 SCAN INDICATOR** (p. 6)  
Appears when the scan function is selected.
- 4 BUSY INDICATOR** (pp. 4, 5)  
Appears when receiving a signal or when the squelch is open.

- 5 TX INDICATOR** (p. 4)  
Appears while transmitting.

- 6 FREQUENCY DISPLAY**
  - Shows the operating frequency. (p. 4)
  - Shows the channel name when the memory name function is selected. (p. 10)

- 7 VOLUME LEVEL INDICATORS**  
Shows the AF volume level (while receiving).

- 8 SET MODE INDICATOR** (p. 10)  
Appears when the Initial Set mode is selected.

- 9 LOCK OUT INDICATOR** (p. 8)  
Appears when the channel is set as a 'LOCK OUT' channel.

- 10 MEMORY CHANNEL INDICATOR**
  - Displays the selected memory channel number
  - "Pr" appears when the priority channel is selected.

### OPTION

**\*NOTE:** The VFO/memory switch [V/M] and the memory write switch [MW](V/M) functions may not be available, depending on the version.

## ■ Power ON

- ① Push [POWER] to turn ON the power.
- ② Operate the transceiver as described in the following sections.



- ③ Select the desired memory channel (or VFO frequency) with the [V/M] keys.
  - When receiving a signal, “**BUSY**” appears and audio is heard from the speaker.
  - Further adjustment of the audio level may be necessary at this point.
  - Push [SQL] to adjust the squelch level. (p. 5)
  - Hold down [TS](DIAL) for 1 second to select the tuning step. 1 MHz or 10 kHz are selectable. (p. 5)
- ④ Hold down [PTT] to transmit, then speak into the microphone at your normal voice level.
  - Transmit indicator “**TX**” lights.
- ⑤ Release [PTT] to receive.

## ■ Channel selection

### ◇ VFO/Memory selection

Push [V/M] to select the Memory mode or the VFO mode.

- ➔ Rotate [DIAL] to select a desired frequency or channel.



### ◇ External speaker output control

External speaker output can be turned OFF, if desired.

- ① Hold down [SQL] for 1 second.
- ② Rotate [DIAL] to select “SP OFF”.
- ③ Push [SQL] to return to the previous mode.

▨ **NOTE:** This function is available for both internal and external speakers.

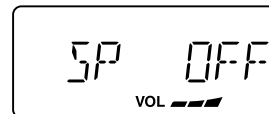

## 2 BASIC OPERATION

### ■ Squelch function

The transceiver has a noise squelch circuit to mute undesired noise while receiving no signals.

#### ◇ Setting the squelch level

- ① Push [SQL] to turn ON the level adjusting mode.
- ② Rotate [DIAL] to select the squelch level.
  - ‘SQ 01’ is loose squelch and ‘SQ 25’ is tight squelch. (Initial level is ‘SQ 01’)
  - ‘SQ 01’ indicates that the squelch circuit is turned off.
  - “ **BUSY** ” appears on the display.
- ③ Push [SQL] to return to regular operation.

### ■ Sidetone function

When using an optional headset, such as those from the David Clark Co. using the OPC-871 HEAD SET ADAPTER, the transceiver outputs your transmitted voice to the headset for monitoring. (p. 16)

### ■ LCD backlight control

The backlight of the LCD can be set to OFF, Low or High.

- ➡ Push [DIAL] to toggle the backlight control; OFF, Low or High are selectable.

### ■ Dial select function OPTION

Use the dial select function to adjust the tuning steps of the [DIAL] keys. Use 1 MHz tuning when you want to change the frequency in large increments; use regular tuning (25 kHz or 8.33 kHz) when you want to change the frequency in smaller increments.

- ① Push [V/M] to select VFO mode.
- ② Hold down [TS](DIAL) for 1 second to select the desired tuning increment.
  - 1 MHz tuning or regular tuning steps can be selected. (see the diagrams to the right)
- ③ Hold down [TS](DIAL) for 1 second to return to normal operation.



1 MHz tuning selected



Regular tuning selected

**NOTE:** Large tuning steps should be used only when you want to change the frequency in large increments. Please select regular tuning steps for normal operation.



## ■ Scan operation OPTION

- ① Push [V/M] to select the Memory mode or the VFO mode, if necessary.
  - “[M]” appears when in the Memory mode.
- ② Make sure the squelch level is set to the threshold point.
  - Set the squelch level (01 to 25) where the noise is just muted.
- ③ Push [SCAN] to start the scan.
  - To change the scan direction, turn [DIAL].
  - “SCAN (or P SCAN)” flashes while scanning.
- ④ Push [SCAN] again to stop the scan.

/// **NOTE:** Normal scan or Priority scan is pre-programmed by cloning. Please ask your dealer or system operator for details.

### ◇ NORMAL SCAN

#### • Memory lock scan

Repeatedly scans memory channels except skip (lockout) channels.

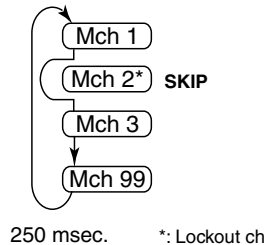

#### • VFO scan

Repeatedly scans all frequencies over the entire band.

Scan step is minimum channel spacing. (e.g. 25 kHz or 8.33 kHz)

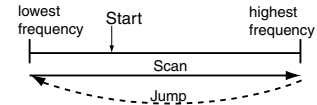

### ◇ PRIORITY SCAN

#### • Priority memory scan

While scanning in the Memory mode, priority watch checks for a signal on the selected priority channel every 250 milliseconds, and skips the lockout channel(s).

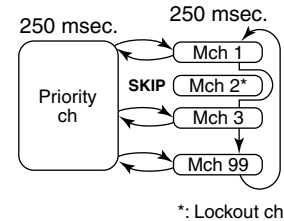

### 3 SCAN OPERATION

#### ■ ON–Hook scan OPTION

An ON–Hook scan (Hanger scan) stops when taking the microphone off its hanger (OFF–Hook) and resumes when putting it back on the hanger (ON–Hook).

- ➔ Push [SCAN] to start scanning.
  - When a signal is received, the scan pauses until the signal disappears.
  - The scan resumes 2 seconds after the signal disappears, unless you pushed [PTT] and transmitted.
- Take the microphone off the hanger to stop the scan.
- Put the microphone back on the hanger to resume scanning.

When you take the microphone OFF Hook during the scan operation.

- In VFO scan;  
the scan stops on the last frequency that was scanned.
- In memory scan;  
the scan stops on the last memory channel that was scanned.
- In priority memory scan;  
the scan stops on the priority channel.

**NOTE:** Be sure to connect the supplied microphone hanger to the vehicle's ground for ON and OFF Hook microphone functions. (p. 12)

#### ■ Dualwatch

Dualwatch monitors the priority channel while you are receiving another channel (VFO or memory channel).

- If a signal is received on the priority channel, dualwatch pauses on the priority channel until the signal disappears.
- To transmit on the selected channel during dualwatch, hold down [PTT].

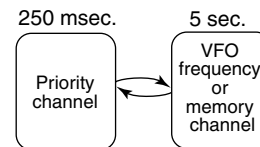

/// See page 11 for details of the priority channel setting.

#### ◇ Operation

- ① Select the desired operating channel (VFO or Memory channel).
- ② Hold down [PRI] for 1 second to start dualwatch.
  - “P” blinks during dualwatch.
- ③ To cancel dualwatch, push [PRI] again.

## ■ Programming a memory channel OPTION

The transceiver has 99 memory channels for storage of often-used frequencies.

- ① Push [V/M] to select the VFO mode, if necessary.
- ② Rotate [DIAL] to select the desired frequency.
  - Push [TS](DIAL) one or more times to use the dial select function, if desired.
- ③ Hold down [MW](V/M) for 5 seconds to enter memory programming mode.
  - “MR” and memory channel number appear.
- ④ Rotate [DIAL] to select the desired memory channel number.
- ⑤ Hold down [MW](V/M) for 1 second to program the information into the channel and return to VFO mode.
  - To clear the memory information, hold down [SQL] for 1 second.

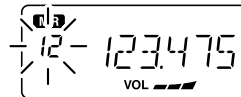
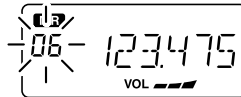

### ◇ Setting lockout channels

In order to speed up the scan periods, you can set memory channels you don't wish to be scanned as lockout channels.

- ① Push [V/M] to select the Memory mode, if necessary.
  - “MR” appears.
- ② Rotate [DIAL] to select a memory channel to set as a lockout channel.
- ③ Hold down [SCAN] for 5 seconds to toggle the lockout setting ON or OFF.
  - “LOCK OUT” appears when the channel is set as a lockout channel.



Memory channel 8 is set as a lockout channel.

#### OPTION

**\*NOTE:** The VFO/memory switch [V/M] and the memory write switch [MW] functions may not be available, depending on version.

## 4 MEMORY PROGRAMMING

### ■ Memory names OPTION

#### ◇ Programming memory names

- ① Select the memory channel to be programmed:
    - Push [V/M] to select the Memory mode.
    - Rotate [DIAL] to select the memory channel.
  - ② Hold down [MW](V/M) for 5 seconds to enter memory name writing mode.
    - The first digit blinks.
  - ③ Repeatedly rotate [DIAL] to select the desired character.
    - To erase a character, overwrite with a space (displayed as \_).
    - To move the cursor forwards or backwards, push [▲] or [▼].
    - Hold down [SQL] for 2 seconds to erase all characters.
  - ④ Hold down [MW](V/M) for 1 second to input the entered name.
    - The character stops blinking.
    - Memory channels can be programmed with names of up to 7 characters in length.
    - When no name is programmed, the display shows the operating frequency.
- NOTE:** Push [PTT] to cancel the memory name programming.
- The following characters can be used in names:
    - 0 to 9, A to Z (capitals), (space), \$, %, ', (, ), \*, +, “, ”, -, /, <, =, >, ?, @, [, \, ], ^, \_ and `.

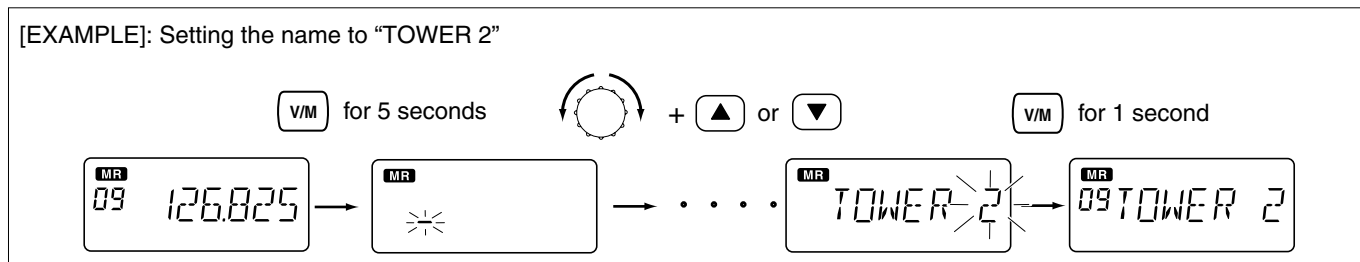

## Initial Set mode

The Initial Set mode is entered at Power ON and allows you to set seldom-changed settings. In this way you can “customize” the transceiver operations to suit your preferences and operating style.

### ◇ Entering Initial Set mode

- ① While holding down [V/M] + [TS](DIAL), push [POWER] to turn ON the power.
  - The transceiver enters the Initial Set mode and “MN”, “BP”, “ST” or “PR” (p. 11) appears on the display.

- ② Push [TS](DIAL) to select the desired item as described below and to the right.



- ③ Rotate [DIAL] to select the desired option or setting.

- ④ Turn OFF the power, then ON again to exit the Initial Set mode and return to the previous operating mode.



### ◇ Memory names

This item allows you to display a memory name instead of the frequency.

- When a memory channel has not been programmed with a name, the frequency appears instead.

### ◇ Beep tones ON/OFF

Confirmation beep tones normally sound when you push a key. These can be turned ON or OFF, as you prefer.

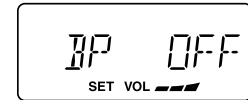
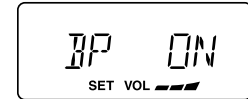

### ◇ Sidetones ON/OFF

When using an optional headset such as those from the David Clark Co. using an the adapter, the transceiver outputs your transmitted voice to the headset for monitoring.

- Optional **OPC-871** HEADSET ADAPTER is required.



## 5 OTHER FUNCTION

### ◇ Priority channel OPTION

The priority channel is used to store your most often-used channel for quick recall. In addition, the priority channel is monitored during priority scan modes. The default setting for the priority channel will differ, depending on pre-programming.

➔ Push [PRI] to toggle the priority channel mode or the previous mode.



#### • Setting the priority channel

- ① While holding down [V/M] and [TS](DIAL), push [POWER] to turn ON the power.
  - The transceiver enters the Initial Set mode.
- ② Push [TS](DIAL) to select the priority channel Set mode.
- ③ Rotate [DIAL] to select the desired channel number as a priority channel or OFF.
- ④ Hold down [POWER] to turn OFF the power.

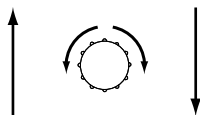
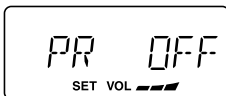

/// **NEVER** select the blank memory channel as the priority channel. In such a case the priority function is automatically set to the OFF position.

## ■ Cloning

### ◇ Data cloning

Data can be cloned to and from a PC using the optional CS-A110EURO CLONING SOFTWARE and the optional OPC-478 CLONING CABLE+ OPC-592 CLONING CABLE ADAPTER.

Consult the CS-A110EURO CLONING SOFTWARE HELP message for details.

### ◇ Cloning error

When the display to the right appears, a cloning error has occurred.

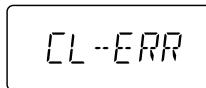

In this case, transceiver automatically return to the clone standby mode and cloning must be repeated.

## ■ Rear panel and connections

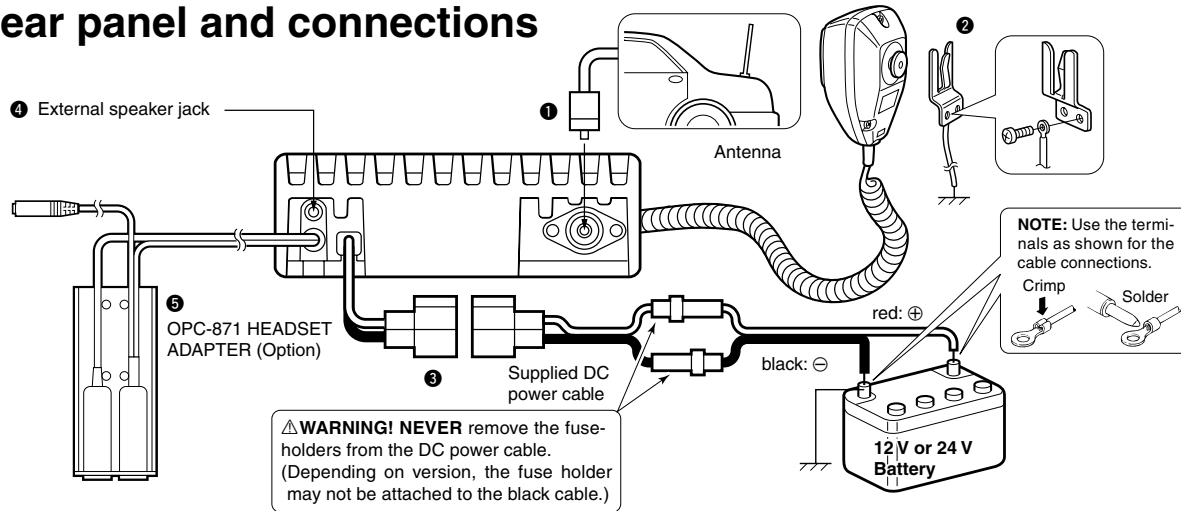

### 1 Connects to an antenna

Ask your dealer about antenna selection and best installation location. (Standard 50 Ω antenna with an SWR <3.0)

### 2 MICROPHONE HANGER

Connect the supplied microphone hanger to the vehicle's ground to use the hanger scan function when hanging or removing the microphone.

### 3 DC POWER RECEPTACLE

Connects to a 12 or 24 V DC battery. Pay attention to polarities.

**⚠ WARNING! NEVER** connect to a over 27.5 V battery. This could damage the transceiver.

### 4 EXTERNAL SPEAKER JACK

Connect an 8 Ω, 30 W (Min.) external speaker, if desired. **CAUTION: DO NOT** use an external speaker whose power input rating is less than 30 W or whose impedance is less than 8 Ω. Using a speaker of less than 30 W power rating, or less than 8 Ω impedance, could cause damage to the external speaker or to the transceiver itself.

### 5 OPC-871 OPTIONAL HEADSET ADAPTER

Connect an optional headset. (See p. 16)

## 6 CONNECTION AND INSTALLATION

### ■ Mounting

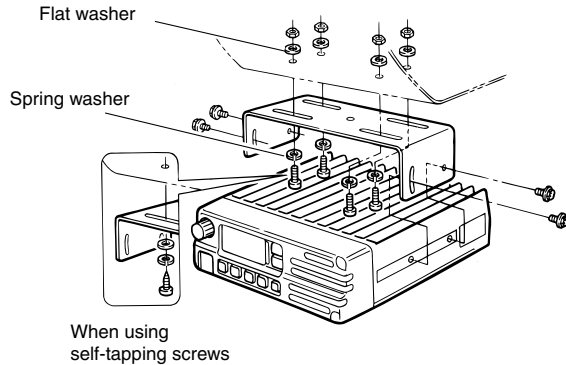

The universal mounting bracket supplied with your transceiver allows overhead or dashboard mounting. Please read the following instructions carefully.

- Mount the transceiver securely with the 4 supplied screws (M5 × 20) to a surface which is more than 10 mm thick and can support more than 5 kg.
- Mount the transceiver so that the face of the transceiver is at 90° to your line of sight when operating.

### ■ Supplied accessories

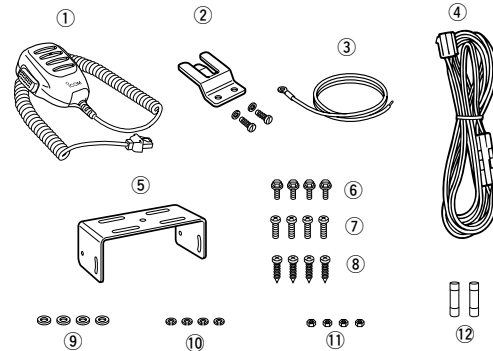

|   |                                       |       |
|---|---------------------------------------|-------|
| ① | Microphone .....                      | 1     |
| ② | Microphone hanger and screw set ..... | 1 set |
| ③ | Microphone cable .....                | 1     |
| ④ | DC power cable (OPC-344) .....        | 1     |
| ⑤ | Mounting bracket .....                | 1     |
| ⑥ | Bracket bolts .....                   | 4     |
| ⑦ | Mounting screws (M5 × 12) .....       | 4     |
| ⑧ | Self-tapping screws (M5 × 20) .....   | 4     |
| ⑨ | Flat washers .....                    | 4     |
| ⑩ | Spring washers .....                  | 4     |
| ⑪ | Nuts .....                            | 4     |
| ⑫ | Fuses (10 A) .....                    | 2     |



## ◇ General

- Frequency coverage : 118 to 136.975 MHz
- Channel spacing : 25/8.33 kHz
- Mode : AM (6K00A3E/5K6A3E)
- Number of memory channels: 99
- Acceptable power supply : 13.75<sup>†</sup> V or 27.5<sup>†</sup> V DC  
(negative ground) †Automatic selection
- Usable temp. range : -30°C to +60°C
- Frequency stability : ±5 ppm
- Current drain (at 13.75 V DC):
  - Tx : 5 A (max.)
  - Rx : 4 A ( at AF max.)
  - 0.5 A (at STANDBY)
- Dimensions : 150 (W) × 50 (H) × 180 (D) mm  
(projections not incl.) 5.9(W) × 2(H) × 7.1(D) in
- Weight (approximately) : 1.5 kg; 3 lb 5 oz

## ◇ Transmitter

- Output power : 36 W (pep) typical  
9 W (carrier) typical
- Modulation : Last Stage modulation
- Modulation limiting : 70% to 100%
- Audio harmonic distortion : Less than 10%  
(at 85 % modulation)
- Hum and noise ratio : More than 40 dB
- Spurious emissions : -16dBm or less
- Antenna impedance : Standard 50 Ω with SWR <3

## ◇ Receiver

- Receive system : Double conversion  
superheterodyne
- Intermediate frequencies : 1st 38.85 MHz  
2nd 450 kHz
- Sensitivity (at 6 dB S/N) : Less than 1 μV (pd)
- Squelch sensitivity : Less than 0.35 μV (pd)  
(at threshold)
- Selectivity
  - 25 kHz ch. spacing : More than ±8 kHz (at -6 dB)  
Less than ±17 kHz (at -40 dB)  
Less than ±25 kHz (at -60 dB)
  - 8.33 kHz ch. spacing : More than ±2.778 kHz (at -6 dB)  
Less than ±7.37 kHz (at -60 dB)
- Spurious response rej. : More than 74 dBμ
- Audio output power : More than 10 W (at 13.75 V  
DC with 8 Ω load 60% MOD.  
10% distortion)
- Sidetone : More than 100 mW (with 500 Ω  
load 60% MOD. 10% distortion)
- Hum and noise : More than 25 dB
- Audio output impedance : Ext. SP 8 Ω  
Sidetone 500 Ω

**All stated specifications are subject to change without notice or obligation.**

## 7 SPECIFICATIONS (VFO CHANNEL ID LIST)

- Channel spacing: 25 kHz (Actual frequency is displayed.)

| Operating Frequency (MHz) | Channel spacing (kHz) | Channel ID* (Displayed Frequency) |
|---------------------------|-----------------------|-----------------------------------|
| 118.0000                  | 25                    | 118.000                           |
| 118.0250                  | 25                    | 118.025                           |
| 118.0500                  | 25                    | 118.050                           |
| 118.0750                  | 25                    | 118.075                           |
| 118.1000                  | 25                    | 118.100                           |

- Channel spacing: 8.33 kHz

| Operating Frequency (MHz) | Channel spacing (kHz) | Channel ID* (Displayed Frequency) |
|---------------------------|-----------------------|-----------------------------------|
| 118.0000                  | 8.33                  | 118.005                           |
| 118.0083                  | 8.33                  | 118.010                           |
| 118.0167                  | 8.33                  | 118.015                           |
| 118.0250                  | 8.33                  | 118.030                           |
| 118.0333                  | 8.33                  | 118.035                           |
| 118.0417                  | 8.33                  | 118.040                           |
| 118.0500                  | 8.33                  | 118.055                           |
| 118.0583                  | 8.33                  | 118.060                           |
| 118.0667                  | 8.33                  | 118.065                           |
| 118.0750                  | 8.33                  | 118.080                           |
| 118.0833                  | 8.33                  | 118.085                           |
| 118.0917                  | 8.33                  | 118.090                           |
| 118.1000                  | 8.33                  | 118.105                           |

- Channel spacing: 25/8.33 kHz auto selection mode

| Operating Frequency (MHz) | Channel spacing (kHz) | Channel ID* (Displayed Frequency) |
|---------------------------|-----------------------|-----------------------------------|
| 118.0000                  | 25                    | 118.000                           |
| 118.0000                  | 8.33                  | 118.005                           |
| 118.0083                  | 8.33                  | 118.010                           |
| 118.0167                  | 8.33                  | 118.015                           |
| 118.0250                  | 25                    | 118.025                           |
| 118.0250                  | 8.33                  | 118.030                           |
| 118.0333                  | 8.33                  | 118.035                           |
| 118.0417                  | 8.33                  | 118.040                           |
| 118.0500                  | 25                    | 118.050                           |
| 118.0500                  | 8.33                  | 118.055                           |
| 118.0583                  | 8.33                  | 118.060                           |
| 118.0667                  | 8.33                  | 118.065                           |
| 118.0750                  | 25                    | 118.075                           |
| 118.0750                  | 8.33                  | 118.080                           |
| 118.0833                  | 8.33                  | 118.085                           |
| 118.0917                  | 8.33                  | 118.090                           |
| 118.1000                  | 25                    | 118.100                           |
| 118.1000                  | 8.33                  | 118.105                           |

These tables show just the display example between 118.0000 MHz and 118.1000 MHz, not show all frequencies in the band.

\*The Channel IDs are displayed according to RTCA/DO-186B standards.

## ■ OPC-871 Headset adapter

When using a headset (supplied from 3rd party) with an adapter, the transceiver outputs your transmitted voice to the headset for monitoring. (pp. 5, 10)

### ◇ Connection

#### PTT switch

Use a PTT switch with a 3.5 mm diameter plug, if required.

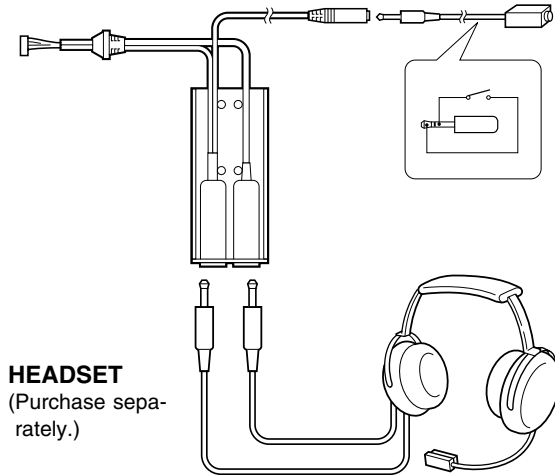

### ◇ Installation

The optional OPC-871 HEADSET ADAPTER is installed as follows.

- ① Turn OFF the power, then disconnect the DC power cable.
- ② Unscrew the 4 screws, then remove the bottom cover. (Fig. 1)
- ③ Insert the connector as shown below. (Fig. 2)
- ④ Mount the phone plug attachment together with the mobile mounting bracket with 2 supplied screws. (Fig. 3)

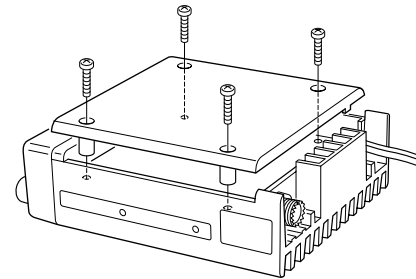

Fig. 1

## 8 OPTIONS

- Bend the plastic dust cover down before installing the strain relief into the notch.

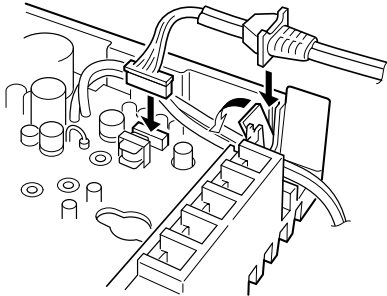

Fig. 2

- Use the upper side mounting hole.
- You can mount the attachment on either side of the transceiver.

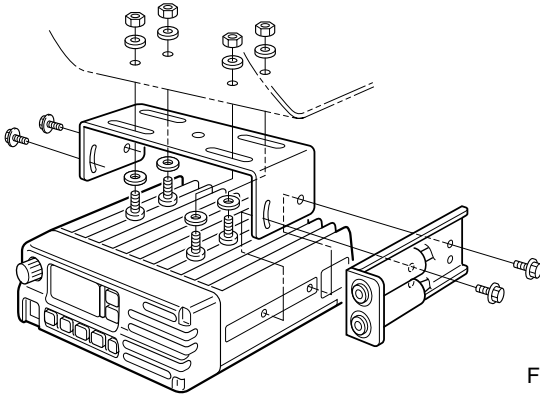

Fig. 3

## Other options

**OPC-871 HEADSET ADAPTER** (Also see p. 16)

**CS-A110EURO CLONING SOFTWARE**

Provides quick and easy programming of items, including private channels, scan settings, etc. to the transceiver, using a PC.

**OPC-478 CLONING CABLE**

**OPC-592 CLONING CABLE ADAPTER**

These three components work as one set and provide for quick and easy programming of items, including memory channels, memory names and set mode contents, etc. with a PC.

Approved Icom optional equipment is designed for optimal performance when used with an Icom transceiver.

Icom is not responsible for the destruction or damage to an Icom transceiver in the event the Icom transceiver is used with equipment that is not manufactured or approved by Icom.

This equipment has been tested and found to comply with the limits for a Class B digital device, pursuant to part 15 of the FCC Rules. These limits are designed to provide reasonable protection against harmful interference in a residential installation. This equipment generates, uses and can radiate radio frequency energy and, if not installed and used in accordance with the Instructions, may cause harmful interference to radio communications. However, there is no guarantee that interference will not occur in a particular installation. If this equipment does cause harmful interference to radio or television reception, which can be determined by turning the equipment off and on, the user is encouraged to try to correct the interference by one or more of the following measures:

- Reorient or relocate the receiving antenna.
- Increase the separation between the equipment and receiver.
- Connect the equipment into an outlet on a circuit different from that to which the receiver is connected.
- Consult the dealer or an experienced radio/TV technician for help.

# 10 SAFETY TRAINING INFORMATION



Your Icom radio generates RF electromagnetic energy during transmit mode. This radio is designed for and classified as “Occupational Use Only”, meaning it must be used only during the course of employment by individuals aware of the hazards, and the ways to minimize such hazards. This radio is **NOT** intended for use by the “General Population” in an uncontrolled environment.

- For compliance with FCC and Industry Canada RF Exposure Requirements, the transmitter antenna installation shall comply with the following two conditions:
  1. The transmitter antenna gain shall not exceed 0 dBi.
  2. The antenna is required to be located outside of a vehicle and kept at a distance of 38 centimeters or more between the transmitting antenna of this device and any persons during operation. For small vehicle as worst case, the antenna shall be located on the roof top at any place on the centre line along the vehicle in order to achieve 38 centimeters separation distance. In order to ensure this distance is met, the installation of the antenna must be mounted at least 38 centimeters away from the nearest edge of the vehicle in order to protect against exposure to bystanders.



To ensure that your exposure to RF electromagnetic energy is within the FCC allowable limits for occupational use, always adhere to the following guidelines:

- **DO NOT** operate the radio without a proper antenna attached, as this may damage the radio and may also cause you to exceed FCC RF exposure limits. A proper antenna is the antenna supplied with this radio by the manufacturer or an antenna specifically authorized by the manufacturer for use with this radio.
- **DO NOT** transmit for more than 50% of total radio use time (“50% duty cycle”). Transmitting more than 50% of the time can cause FCC RF exposure compliance requirements to be exceeded. The radio is transmitting when the “TX indicator” appears. You can cause the radio to transmit by pressing the “PTT” switch.

## **Electromagnetic Interference/Compatibility**

During transmissions, your Icom radio generates RF energy that can possibly cause interference with other devices or systems. To avoid such interference, turn off the radio in areas where signs are posted to do so. **DO NOT** operate the transmitter in areas that are sensitive to electromagnetic radiation such as hospitals, aircraft, and blasting sites.



Votre radio Icom produit une énergie électromagnétique de radiofréquences (RF), en mode de transmission. Cette radio est conçue pour un «usage professionnel seulement» et classée comme tel, ce qui signifie qu'elle doit être utilisée uniquement dans le cadre d'un travail par des personnes conscientes des dangers et des mesures visant à minimiser ces dangers. Elle **N'EST PAS** conçue pour une «utilisation grand public», dans un environnement non contrôlé.

- Afin de satisfaire aux exigences de la FCC et d'Industrie Canada en matière d'exposition aux RF, il est nécessaire que l'antenne soit installée conformément aux deux conditions suivantes:
  1. Le gain de l'antenne du radio émetteur ne doit pas dépasser 0 dBi.
  2. Il faut que l'antenne émettrice de cet appareil soit placée à l'extérieur d'un véhicule et tenue éloignée d'au moins 38 centimètres de toute personne pendant le fonctionnement. Dans le pire des cas, pour un petit véhicule, l'antenne doit être placée sur le toit, n'importe où dans l'axe central du véhicule, afin de respecter une distance de 38 cm du bord le plus rapproché du véhicule et ainsi éviter que les personnes présentes soient exposées.



Afin de vous assurer que votre exposition à une énergie électromagnétique de RF se situe dans les limites permises par la FCC pour une utilisation grand public, veuillez en tout temps respecter les directives suivantes:

- **NE PAS** faire fonctionner la radio sans qu'une antenne appropriée y soit fixée, car ceci risque d'endommager la radio et causer une exposition supérieure aux limites établies par la FCC. L'antenne appropriée est celle qui est fournie avec cette radio par le fabricant ou une antenne spécialement autorisée par le fabricant pour être utilisée avec cette radio.
- **NE PAS** émettre pendant plus de 50 % du temps total d'utilisation de l'appareil («50% du facteur d'utilisation»). Émettre pendant plus de 50% du temps total d'utilisation peut causer une exposition aux RF supérieure aux limites établies par la FCC. La radio est en train d'émettre lorsque le témoin du mode de transmission s'affiche sur l'écran ACL. La radio émettra si vous appuyez sur le bouton du microphone.

### Interférence électromagnétique et compatibilité

En mode de transmission, votre radio Icom produit de l'énergie de RF qui peut provoquer des interférences avec d'autres appareils ou systèmes. Pour éviter de telles interférences, mettez la radio hors tension dans les secteurs où une signalisation l'exige. **NE PAS** faire fonctionner l'émetteur dans des secteurs sensibles au rayonnement électromagnétique tels que les hôpitaux, les aéronefs et les sites de dynamitage.

**Count on us!**

A-6940H-1EX-0a  
Printed in Japan  
© 2011 Icom Inc.

Printed on recycled paper with soy ink.

**Icom Inc.**

1-1-32 Kamiminami, Hirano-ku, Osaka 547-0003, Japan