



INSTRUCTION MANUAL

VHF MARINE TRANSCEIVER IC-M34

This device complies with Part 15 of the FCC Rules. Operation is subject to the condition that this device does not cause harmful interference.

Icom Inc.



SAFETY TRAINING INFORMATION



Your Icom radio generates RF electromagnetic energy during transmit mode. This radio is designed for and classified as “Occupational Use Only”, meaning it must be used only during the course of employment by individuals aware of the hazards, and the ways to minimize such hazards. This radio is NOT intended for use by the “General Population” in an uncontrolled environment.

This radio has been evaluated for compliance at the distance of 2.5 cm with the FCC RF exposure limits for “Occupational Use Only”. In addition, your Icom radio complies with the following Standards and Guidelines with regard to RF energy and electromagnetic energy levels and evaluation of such levels for exposure to humans:

- FCC OET Bulletin 65 Edition 97-01 Supplement C, Evaluating Compliance with FCC Guidelines for Human Exposure to Radio Frequency Electromagnetic Fields.
- American National Standards Institute (C95.1-1992), IEEE Standard for Safety Levels with Respect to Human Exposure to Radio Frequency Electromagnetic Fields, 3 kHz to 300 GHz.
- American National Standards Institute (C95.3-1992), IEEE Recommended Practice for the Measurement of Potentially Hazardous Electromagnetic Fields– RF and Microwave.
- The following accessories are authorized for use with this product. Use of accessories other than those specified may result in RF exposure levels exceeding the FCC requirements for wireless RF exposure.: Belt Clip (MB-109), Rechargeable Li-Ion Battery Pack (BP-252) and Alkaline Battery Case (BP-251).



To ensure that your exposure to RF electromagnetic energy is within the FCC allowable limits for occupational use, always adhere to the following guidelines:

- **DO NOT** operate the radio without a proper antenna attached, as this may damage the radio and may also cause you to exceed FCC RF exposure limits. A proper antenna is the antenna supplied with this radio by the manufacturer or antenna specifically authorized by the manufacturer for use with this radio.
- **DO NOT** transmit for more than 50% of total radio use time (“50% duty cycle”). Transmitting more than 50% of the time can cause FCC RF exposure compliance requirements to be exceeded. The radio is transmitting when the “TX indicator” lights red. You can cause the radio to transmit by pressing the “PTT” switch.
- **ALWAYS keep** the antenna at least 2.5 cm (1 inch) away from the body when transmitting and only use the Icom belt-clips which are listed on page 29 when attaching the radio to your belt, etc., to ensure FCC RF exposure compliance requirements are not exceeded. To provide the recipients of your transmission the best sound quality, hold the antenna at least 5 cm (2 inches) from your mouth, and slightly off to one side.

The information listed above provides the user with the information needed to make him or her aware of RF exposure, and what to do to assure that this radio operates with the FCC RF exposure limits of this radio.

Electromagnetic Interference/Compatibility

During transmissions, your Icom radio generates RF energy that can possibly cause interference with other devices or systems. To avoid such interference, turn off the radio in areas where signs are posted to do so. **DO NOT** operate the transmitter in areas that are sensitive to electromagnetic radiation such as hospitals, aircraft, and blasting sites.

Occupational/Controlled Use

The radio transmitter is used in situations in which persons are exposed as consequence of their employment provided those persons are fully aware of the potential for exposure and can exercise control over their exposure.

IN CASE OF EMERGENCY

If your vessel requires assistance, contact other vessels and the Coast Guard by sending a distress call on Channel 16.

○ **USING CHANNEL 16**

DISTRESS CALL PROCEDURE

1. "MAYDAY MAYDAY MAYDAY."
2. "THIS IS" (name of vessel)
3. Your call sign or other indication of the vessel.
4. "LOCATED AT" (your position)
5. The nature of the distress and assistance required.
6. Any other information which might facilitate the rescue.

RECOMMENDATION

CLEAN THE TRANSCEIVER THOROUGHLY WITH FRESH WATER after exposure to saltwater, and dry it before operation. Otherwise, the transceiver's keys, switches and controllers may become unusable due to salt crystallization.

NOTE: DO NOT wash the transceiver in water if there is any reason to suspect the waterproofing may not be effective. For example, in cases where the battery pack rubber seal is damaged, the transceiver/battery pack is cracked or broken, or has been dropped, or when the battery pack is detached from the transceiver.

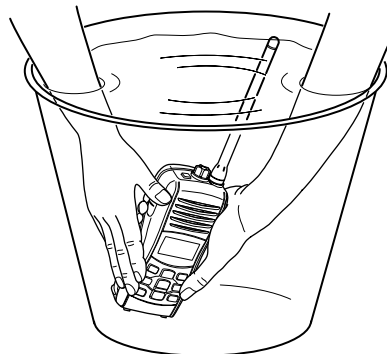

FOREWORD

Thank you for purchasing this Icom radio. The IC-M34 VHF MARINE TRANSCEIVER is designed and built with Icom's state of the art technology and craftsmanship. With proper care this radio should provide you with years of trouble-free operation.

IMPORTANT

READ ALL INSTRUCTIONS carefully and completely before using the transceiver.

SAVE THIS INSTRUCTION MANUAL—This instruction manual contains important operating instructions for the IC-M34.

EXPLICIT DEFINITIONS

WORD	DEFINITION
⚠ WARNING	Personal injury, fire hazard or electric shock may occur.
CAUTION	Equipment damage may occur.
NOTE	If disregarded, inconvenience only. No risk of personal injury, fire or electric shock.

FEATURES

Submersible construction

Built tough to withstand the punishing marine environment, the IC-M34's submersible construction meets IPX7 of the corresponding International Standard IEC 60529 (2001) while using BP-251 (option) or BP-252.

Floating on water

The IC-M34 floats on fresh or salt water even when the supplied accessories are attached.

- When third-party battery pack, strap, antenna, etc. is used, it may sink.
- The battery contacts may be prone to rusting if the transceiver is kept floating in fresh or salt water.



Large, easy-to-read LCD

With dimensions of 16(H) × 32(W) mm; $\frac{5}{8}$ (H) × 1 $\frac{1}{4}$ (W) inch, the IC-M34's function display is easy to read and shows operating conditions at a glance. Backlighting and contrast can be adjusted to suit your preferences.

Simple operation

9 large buttons on the front panel provide user-friendly operation. The independent volume and channel buttons are located on the front panel for convenient one-hand operation.

PRECAUTIONS

⚠ WARNING! NEVER connect the transceiver to an AC outlet. This may pose a fire hazard or result in an electric shock.

⚠ WARNING! NEVER hold the transceiver so that the antenna is closer than 2.5 cm (1 inch) from exposed parts of the body, especially the face or eyes, while transmitting. The transceiver will perform best if the microphone is 5 to 10 cm (2 to 4 inches) away from the lips and the transceiver is vertical.

NEVER connect the transceiver to a power source other than the BP-251 (option) or BP-252. Such a connection will ruin the transceiver.

AVOID using or placing the transceiver in direct sunlight or in areas with temperatures below -20°C (-4°F) or above $+60^{\circ}\text{C}$ ($+140^{\circ}\text{F}$).

KEEP the transceiver out of the reach of children.

KEEP the transceiver at least 0.9 meters (3.0 ft) away from your vessel's magnetic navigation compass.

BE CAREFUL! The transceiver's right-side panel will become hot when operating continuously for long periods.

BE CAREFUL! The transceiver employs waterproof construction, which corresponds to IPX7 of the international standard IEC 60529 (2001). However, once the transceiver has been dropped, waterproofing cannot be guaranteed due to the fact that the transceiver may be cracked, or the waterproof seal damaged, etc.

MAKE SURE the flexible antenna and battery pack are securely attached to the transceiver, and that the antenna and battery pack are dry before attachment. Exposing the inside of the transceiver to water will result in serious damage to the transceiver.

After exposure to water, clean the battery contacts thoroughly with fresh water and dry them completely to remove any water or salt residue.

For U.S.A. only

CAUTION: Changes or modifications to this device, not expressly approved by Icom Inc., could void your authority to operate this device under FCC regulations.

Icom, Icom Inc. and the ICOM logo are registered trademarks of Icom Incorporated (Japan) in the United States, the United Kingdom, Germany, France, Spain, Russia and/or other countries.

TABLE OF CONTENTS

SAFETY TRAINING INFORMATION	i	5	SCAN OPERATION	14–15
IN CASE OF EMERGENCY	ii		■ Scan types	14
RECOMMENDATION	ii		■ Setting TAG channels	15
FOREWORD	iii		■ Starting a scan	15
IMPORTANT	iii	6	DUALWATCH/TRI-WATCH	16
EXPLICIT DEFINITIONS	iii		■ Description	16
FEATURES	iii		■ Operation	16
PRECAUTIONS	iv	7	SET MODE	17–20
TABLE OF CONTENTS	v		■ Set mode programming	17
			■ Set mode items	18
1 OPERATING RULES	1	8	BATTERY CHARGING	21–24
2 SUPPLIED ACCESSORIES AND ATTACHMENTS	2–3		■ Battery caution	21
■ Supplied accessories	2		■ Supplied battery charger	23
■ Attachments	2		■ Optional battery case	23
3 PANEL DESCRIPTION	4–7		■ Optional battery charger	24
■ Front, top and side panels	4	9	OPTIONAL SPEAKER-MICROPHONE	25
■ Function display	6		■ HM-165 descriptions	25
4 BASIC OPERATION	8–13		■ Attachment	25
■ Channel selection	8	10	TROUBLESHOOTING	26
■ Receiving and transmitting	10		11 VHF MARINE CHANNEL LIST	27
■ Call channel programming	11		12 SPECIFICATIONS.....	28
■ Adjusting the volume level	11		13 OPTIONS	29
■ Volume mute function	11			
■ Adjusting the squelch level	12			
■ Lock function	12			
■ Automatic backlighting	12			
■ Monitor function	13			
■ AquaQuake water draining function	13			

◇ Priorities

- Read all rules and regulations pertaining to priorities and keep an up-to-date copy handy. Safety and distress calls take priority over all others.
- You must monitor Channel 16 when you are not operating on another channel.
- False or fraudulent distress calls are prohibited under law.

◇ Privacy

- Information overheard but not intended for you cannot lawfully be used in any way.
- Indecent or profane language is prohibited.

◇ Radio licenses

(1) SHIP STATION LICENSE

When your craft is equipped with a VHF FM transceiver, you must have a current radio station license before using the transceiver. It is unlawful to operate a ship station which is not licensed.

Inquire through your dealer or the appropriate government agency for a Ship-Radiotelephone license. This license includes the call sign which is your craft's identification for radio purposes.

(2) OPERATOR'S LICENSE

A restricted Radiotelephone Operator Permit is the license most often held by small vessel radio operators when a radio is not required for safety purposes.

The Restricted Radiotelephone Operator Permit must be posted near the transceiver or be kept with the operator. Only a licensed radio operator may operate a transceiver.

However, non-licensed individuals may talk over a transceiver if a licensed operator starts, supervises, ends the call and makes the necessary log entries.

A current copy of the applicable government rules and regulations is only required to be on hand for vessels in which a radio telephone is compulsory. However, even if you are not required to have these on hand it is your responsibility to be thoroughly acquainted with all pertinent rules and regulations.

NOTE: Even though the IC-M34 is capable of operation on VHF marine channels 3, 21, 23, 61, 64, 81, 82 and 83, according to FCC regulations these simplex channels cannot be lawfully used by the general population in U.S.A. waters.

■ Supplied accessories

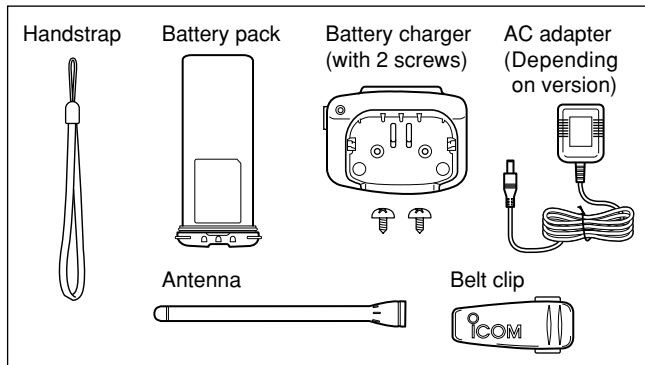

■ Attachments

◇ Flexible antenna

Connect the supplied flexible antenna to the antenna connector.

CAUTION!

- **NEVER** carry the transceiver by the antenna.
- Transmitting without an antenna may damage the transceiver.

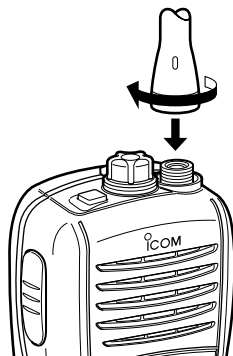

◇ Handstrap

Pass the handstrap through the loop on the side of the transceiver as illustrated at right. This facilitates carrying.

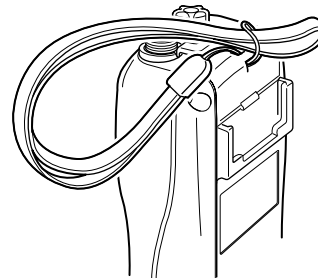

◇ Belt clip

Attach/detach the belt clip to the transceiver as illustrated below.

To attach the belt clip

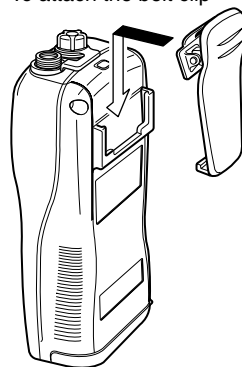

To detach the belt clip



◆ **Battery pack**

To remove the battery pack:

Turn the screw counterclockwise one quarter turn, then pull the battery pack in the direction of the arrow as shown below.

To attach the battery pack:

Insert the battery pack in the IC-M34 completely, then turn the screw clockwise one quarter turn.

NEVER remove or insert the battery pack when the transceiver is wet or soiled. This may result water or dust getting into the transceiver/battery pack and may result in the transceiver being damaged.

NOTE: When removing or attaching the battery pack, use a coin or standard screwdriver to loosen or tighten the bottom screw.

CAUTION!: When attaching or removing a battery pack, make sure the rubber seal is set in the groove of the battery pack correctly. If the seal is not neatly in the groove it may be damaged when attaching the battery pack. If the seal is damaged, waterproofing is not guaranteed.

NOTE: When attaching a battery pack, make sure dust or other material does not adhere to the rubber seal. If dust or other material is on the seal when attaching a battery pack, water resistance may be compromised.

Make sure the rubber seal (purple) is properly seated in the groove and dust or other material does not adhere to it.

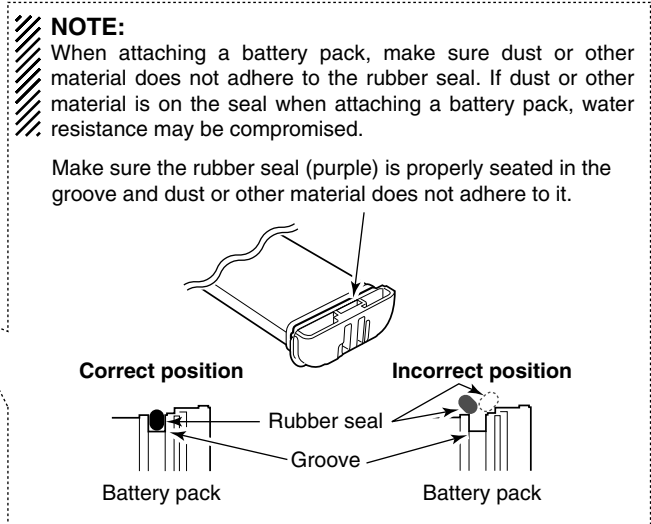
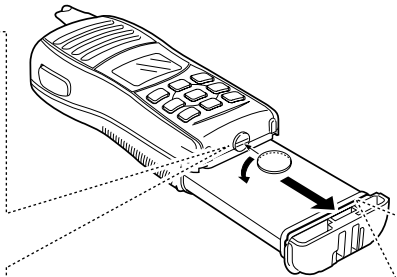
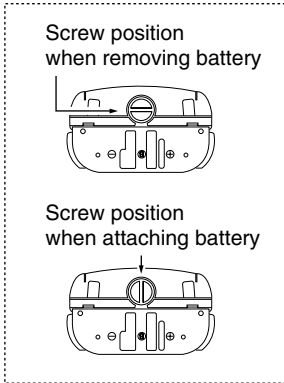

3

PANEL DESCRIPTION

■ Front, top and side panels

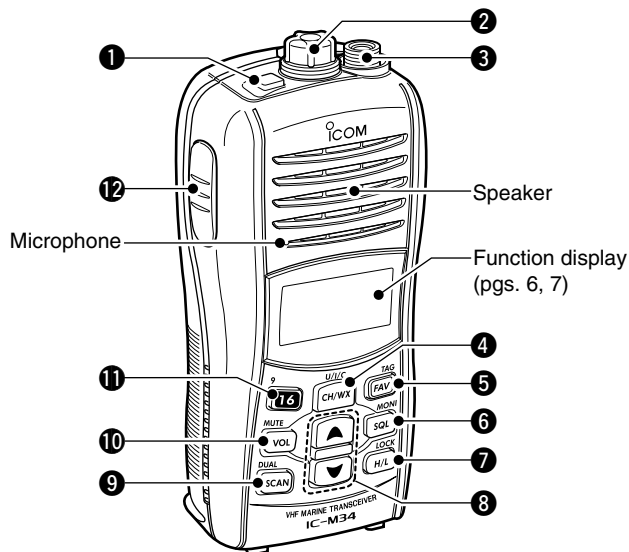

① POWER SWITCH [PWR]

Push and hold to turn power ON and OFF.

② SPEAKER-MICROPHONE CONNECTOR [SP MIC] (p. 25)

Connects the optional external speaker-microphone.

NOTE: Attach the [SP MIC] cap when the optional speaker-microphone is not used. Otherwise, water will get into the transceiver.

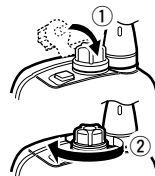

① Attach the [SP MIC] cap.

② Then rotate it clockwise completely.

③ ANTENNA CONNECTOR (p. 2)

Connects the supplied antenna.

④ CHANNEL/WEATHER CHANNEL KEY [CH/WX•U/I/C]

- ➔ Toggles between the regular channel and weather channel when pushed. (p. 9)
- ➔ Selects the U.S.A., International or Canadian channel group when pushed and held for 1 sec. (p. 9)
- ➔ Push to return to the previous channel before selecting channel 16 or the call channel.

5 FAVORITE/TAG KEY [FAV•TAG]

- ➔ While pushing and holding this key, push [▲]/[▼] to select the favorite (TAG) channels with ignoring untagged channels in the selected channel group in sequence. (p. 8)
 - Pushing this key only advances the displayed TAG channel.
- ➔ Push and hold for 1 sec. to set or clear the displayed channel as a TAG (scanned) channel. (p. 15)
- ➔ While pushing and holding this key, turn power ON to clear or set all TAG channels (when no TAG channel has been set) in the selected channel group. (p. 15)

6 SQUELCH/MONITOR KEY [SQL•MONI]

- ➔ Push this key, then adjust the squelch level with [▲]/[▼]. (p. 12)
- ➔ Manually opens the squelch for monitoring the channel while pushing and holding. (p. 13)
- ➔ While pushing and holding this key, turn power ON to enter the set mode. (p. 17)

7 TRANSMIT POWER/LOCK KEY [H/L•LOCK]

- ➔ Selects high or low power when pushed. (p. 10)
- ➔ Toggles between the key lock function ON/OFF when pushed and held for 1 sec. (p. 12)

8 CHANNEL UP/DOWN KEYS [▲]/[▼]

- ➔ Selects an operating channel. (pgs. 8, 9)
- ➔ Selects the set mode setting of the item. (p. 17)
- ➔ Checks TAG channels or changes scanning direction during scan. (p. 15)

9 SCAN/DUAL KEY [SCAN•DUAL]

- ➔ Push to start or stop normal or priority scan. (p. 15)
- ➔ Push and hold for 1 sec. to enter watch mode. (p. 16)
- ➔ Push and hold this key and [H/L], to activate the AquaQuake function. (p. 13)
- ➔ Exits watch mode when pushed during watch operation. (p. 16)

10 VOLUME KEY [VOL•MUTE]

- ➔ Push this key, then adjust the volume level with [▲]/[▼]. (p. 11)
- ➔ Push and hold for 1 sec. to activate the volume mute function. (p. 11)

11 CHANNEL 16 KEY [16•9]

- ➔ Push to select Channel 16. (p. 8)
- ➔ Push and hold for 1 sec. to select the call channel. (p. 8)
- ➔ Enters call channel programming condition when the call channel is selected and this key is pushed and held for 3 sec. (p. 11)
- ➔ Push to exit set mode during set mode operation. (p. 17)

12 PTT SWITCH [PTT]

- ➔ Push and hold to transmit; release to receive. (p. 10)

3 PANEL DESCRIPTION

Function display

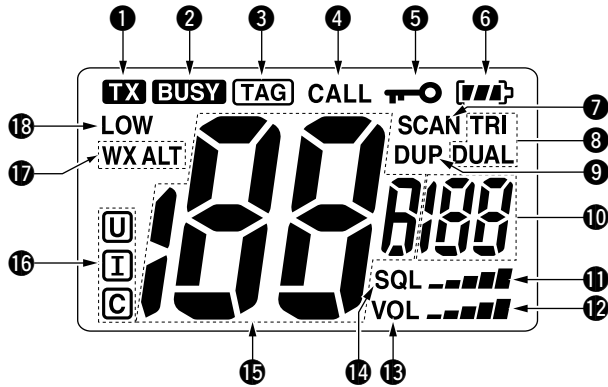

- 1 TRANSMIT INDICATOR** (p. 10)
Appears while transmitting.
- 2 BUSY INDICATOR**
➔ Appears when receiving a signal or when the squelch opens. (p. 10)
➔ Blinks while monitoring. (p. 13)
- 3 TAG CHANNEL INDICATOR** (p. 15)
Appears when a TAG channel is selected.
- 4 CALL CHANNEL INDICATOR** (p. 8)
Appears when the call channel is selected.

- 5 LOCK INDICATOR** (p. 12)
Appears while the lock function is activated.

- 6 BATTERY INDICATOR**
Indicates remaining battery power.

Indication	[]	[]	[]	[]
Battery level	Full	Middle	Charging required	No battery

[||||] blinks when the battery is over charged.

[] blinks when the battery is exhausted.

- 7 SCAN INDICATOR** (p. 15)
Blinks while scanning.
- 8 DUALWATCH/TRI-WATCH INDICATORS** (p. 16)
“DUAL” appears during dualwatch; “TRI” appears during tri-watch.
- 9 DUPLEX INDICATOR**
Appears when a duplex channel is selected.
- 10 SUB CHANNEL READOUT**
➔ Indicates Channel 16 during priority scan, dualwatch or tri-watch. (p. 16)
➔ Indicates the set mode item while in set mode. (p. 17)
➔ Indicates the squelch level while squelch setting. (p. 12)
➔ Indicates the volume level while volume setting. (p. 11)

11 SQUELCH LEVEL INDICATOR

Shows the squelch level.

12 VOLUME LEVEL INDICATOR

➤ Shows the volume level.

➤ Blinks when the volume mute is activated. (p. 11)

13 VOLUME LEVEL ADJUSTING INDICATOR (p. 11)

Blinks while adjusting the volume level.

14 SQUELCH LEVEL ADJUSTING INDICATOR (p. 12)

Blinks while adjusting the squelch level.

15 CHANNEL NUMBER READOUT

➤ Indicates the selected operating channel number.

➤ In set mode, indicates the selected condition.

16 CHANNEL GROUP INDICATOR (p. 9)

“**U**” appears when U.S.A.; “**I**” appears when International; “**C**” appears when Canadian channel group is selected.

17 WEATHER CHANNEL/WEATHER ALERT INDICATORS

(p. 9)

➤ “**WX**” appears when the weather channel group is selected.

➤ “**WX ALT**” appears while the weather alert function is activated; blinks when the alert tone is received.

18 LOW POWER INDICATOR (p. 10)

➤ “**LOW**” appears when low power is selected.

➤ “**LOW**” blinks when switching forced low power mode because of a high temperature error or low voltage.

■ Channel selection

IMPORTANT! Prior to using the transceiver for the first time, the battery pack must be fully charged for optimum life and operation. To avoid damage to the transceiver, turn the power OFF while charging.

◇ Channel 16

Channel 16 is the distress and safety channel. It used for establishing initial contact with a station and for emergency communications. Channel 16 is monitored during both Dual-watch and Tri-watch. While standing by, you must monitor Channel 16.

- ① Push **[16]** momentarily to select Channel 16.
- ② Push **[CH/WX]** to return to the channel used before Channel 16, or push **[▲]/[▼]** to select a channel.

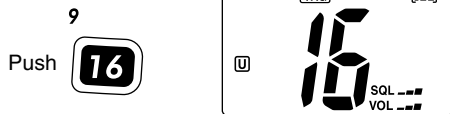

Convenient!

While pushing and holding **[FAV]**, push **[▲]/[▼]** to select the favorite (TAG) channels with ignoring untagged channels in the selected channel group in sequence.

- Pushing **[FAV]** only advances the displayed TAG channel.
- The favorite channels are selected using the TAG channel setting. (p. 15)

◇ Channel 9 (Call channel)

Each regular channel group has separate leisure-use call channels. The call channel is monitored during Tri-watch. The call channels can be programmed (p. 11) and are used to store your most often used channel in each channel group for quick recall.

- ① Push and hold **[9]** (16) for 1 sec. to select the call channel of the selected channel group.
 - “**CALL**” and call channel number appear.
 - Each channel group may have an independent call channel after programming a call channel. (p. 11)
- ② Push **[CH/WX]** to return to the channel used before call channel, or push **[▲]/[▼]** to select a channel.



◇ U.S.A., International and Canadian channels

The IC-M34 is pre-programmed with 59 U.S.A., 59 International and 63 Canadian channels. These channel groups may be specified for the operating area.

- ① Push **[CH/WX]** to select a regular channel.
 - If a weather channel appears, push **[CH/WX]** again.
- ② Push and hold **[U/I/C]** (CH/WX) for 1 sec. to change the channel group. Repeat to advance to the next group.
 - U.S.A., International and Canadian channel groups can be selected in sequence.
- ③ Push **[▲]/[▼]** to select a channel.
 - “**DUP**” appears for duplex channels.

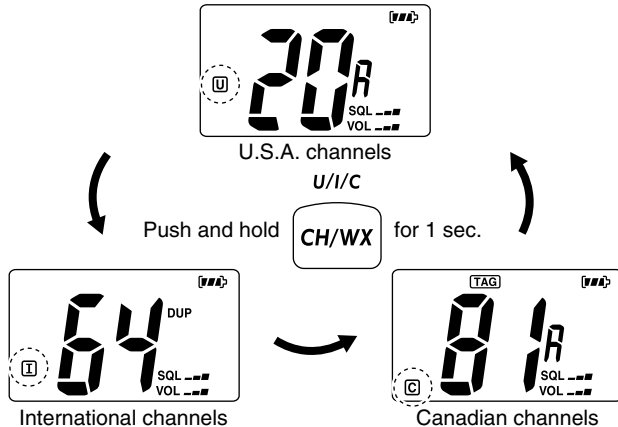

◇ Weather channels

The IC-M34 has 10 pre-programmed weather channels. These are used for monitoring broadcasts from the NOAA (National Oceanic and Atmospheric Administration).

The transceiver can automatically detect a weather alert tone on the selected weather channel while receiving another channel or while scanning. (p. 18)

- ① Push **[CH/WX]** once or twice to select a weather channel.
 - “**WX**” appears when a weather channel is selected.
 - “**WX ALT**” appears when the weather alert function is turned ON. (p. 18)
- ② Push **[▲]/[▼]** to select a weather channel.

U/I/C

Push **CH/WX** once or twice.

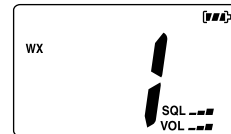

Weather alert is OFF.

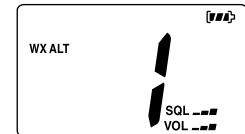

Weather alert is ON.

4 BASIC OPERATION

■ Receiving and transmitting

⚠ **CAUTION:** Transmitting without an antenna will damage the transceiver.

- ① Push and hold **[PWR]** to turn power ON.
- ② Set the audio and squelch levels.
 - Push **[SQL]**, and push **[▼]** several times to open the squelch.
 - Push **[VOL]**, then push **[▲]/[▼]** to adjust the volume level.
 - Push **[SQL]**, and push **[▲]** until the noise disappears.
- ③ Push **[▲]/[▼]** to select the desired channel.
 - When receiving a signal, “**BUSY**” appears and audio is emitted from the speaker.
 - Further adjustment of the audio may be necessary at this point.
- ④ Push **[H/L]** to select the output power if necessary.
 - “**LOW**” appears when low power is selected; no indication when high power is selected.
 - Choose low power to conserve battery power, choose high power for longer distance communications.
 - Some channels are for low power only.
- ⑤ Push and hold **[PTT]** to transmit, then speak into the microphone.
 - “**TX**” appears.
 - Channel 70 cannot be used for transmission.
- ⑥ Release **[PTT]** to receive.

⚠ **IMPORTANT:** To maximize the readability of your transmitted signal, pause a few sec. after pushing **[PTT]**, hold the microphone 2 to 4 inches (5 to 10 cm) from your mouth and speak into the microphone at a normal voice level.

⚠ **NOTE:** The transceiver has a power save function to conserve the battery power. The power save function activates automatically when no signal is received for 5 sec.

⚠ **For U.S.A version:** To prevent accidental prolonged transmission, etc., the IC-M34 has a time-out timer function. This timer cuts a transmission OFF after 5 min. of continuous transmission.

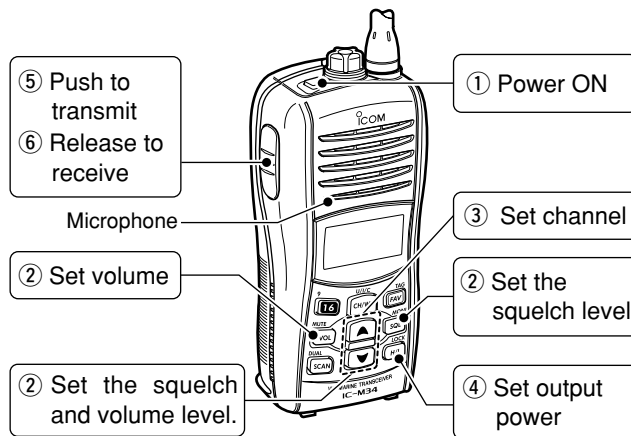

■ Call channel programming

Call channel is used to access Channel 9 (default), however, you can program the call channel with your most often-used channels in each channel group for quick recall.

- ① Push and hold **[U/I/C]** (CH/WX) for 1 sec. several times to select the desired channel group (U.S.A., International or Canada) to be programmed. (p. 9)
- ② Push and hold **[9]** (16) for 1 sec. to select the call channel of the selected channel group.
 - “CALL” and call channel number appear.
- ③ Push and hold **[9]** (16) again for 3 sec. (until a long beep changes to 2 short beeps) to begin call channel programming.
 - Channel number starts blinking.
- ④ Push **[▲]/[▼]** to select the desired channel.
- ⑤ Push **[16]** to program the displayed channel as the call channel.
 - The channel number stops blinking.

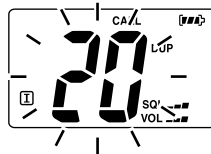
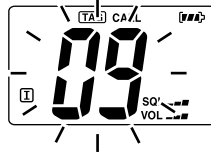

■ Adjusting the volume level

The volume level can be adjusted with **[VOL]** and **[▲]/[▼]**.

- ① Push **[VOL]**, then adjust the volume level with **[▲]/[▼]**.
 - “VOL” indicator starts blinking.
 - There are 31 volume levels and OFF.
 - When no key is pushed for 5 sec., the transceiver returns to normal condition.
- ② Push **[VOL]** again to return to normal condition.

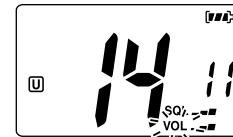

Indicates the volume level.

Blinks during volume level adjustment.

■ Volume mute function

The volume mute function can be activated temporarily with **[MUTE]** (VOL).

- ① Push and hold **[MUTE]** (VOL) for 1 sec to activate the volume mute function.
 - The audio is muted.
 - The volume level indicator starts blinking.
- ② Push **[VOL]** again or turn power OFF to turn the volume mute function OFF.

4 BASIC OPERATION

■ Adjusting the squelch level

To adjust the IC-M34's squelch level, use the [▲]/[▼] keys as described below. In order to receive signals properly, as well as for the scan to function effectively, the squelch must be adjusted to the proper level.

- ① Push [SQL], then adjust the squelch level with [▲]/[▼].
 - "SQL" indicator starts blinking.
 - There are 11 squelch levels to choose from: OP is completely open; 10 is tight squelch; 1 is loose squelch.
 - If no key is pushed for 5 sec., the transceiver returns to normal operation.
- ② Push [SQL] again to return to normal condition.

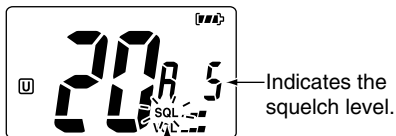

Blinks during squelch level adjustment.

■ Lock function

This function electronically locks all keys (except for [PTT], [SQL•MONI], [VOL•MUTE], [H/L•LOCK] and [▲]/[▼]*) to prevent accidental channel changes and function access.

* After pushing [VOL•MUTE] or [SQL•MONI] only.

- ➔ Push and hold [LOCK] (H/L) for 1 sec. to turn the lock function ON and OFF.

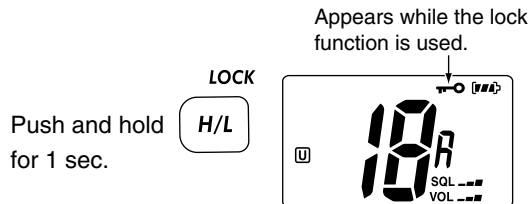

■ Automatic backlighting

This function is convenient for nighttime operation. The automatic backlighting can be activated in set mode. (p. 19)

- ➔ Push any key except for [PTT] to turn the backlighting ON.
- The backlighting is automatically turned OFF after 5 sec. of inactivity.

■ Monitor function

The monitor function opens the squelch. See p. 5 for details of the monitor key action.

- ➔ The monitor function activates while pushing and holding **[MONI]** (SQL).
 - “**BUSY**” blinks and audio is emitted.

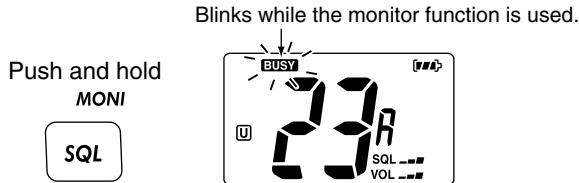

■ AquaQuake water draining function

The IC-M34 uses a new technology to clear water away from the speaker grill: AquaQuake. AquaQuake helps drain water away from the speaker housing (water that might otherwise muffle the sound coming from the speaker). The IC-M34 emits a vibrating beep when this function is being used.

- ➔ Push and hold both **[SCAN]** and **[H/L]**.
 - A low beep tone sounds for 9 sec. to drain water, regardless of volume level setting.
 - The transceiver does not perform key operations while the AquaQuake function is activated. The AquaQuake function can not be activated when an optional speaker-microphone is connected.

■ Scan types

Scanning is an efficient way to locate signals quickly over a wide frequency range. The transceiver has priority scan and normal scan.

In addition, the weather alert and auto scan functions are available for standby convenience. These functions can be activated simultaneously, depending on the setting in set mode. (pgs. 18, 19)

PRIORITY SCAN

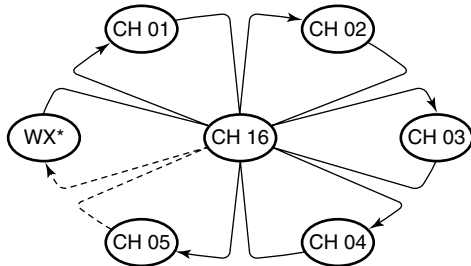

* Previously selected weather channel when weather alert function is ON.

Priority scan searches through all TAG channels in sequence while monitoring Channel 16. When a signal is detected on Channel 16, scan pauses until the signal disappears; when a signal is detected on a channel other than Channel 16, scan becomes dualwatch until the signal disappears.

Set the TAG channels (scanned channels) before scanning. Clear any TAG channels which inconveniently stop scanning, such as digital communications.

∕∕ Choose priority or normal scan in set mode. (p. 18)

NORMAL SCAN

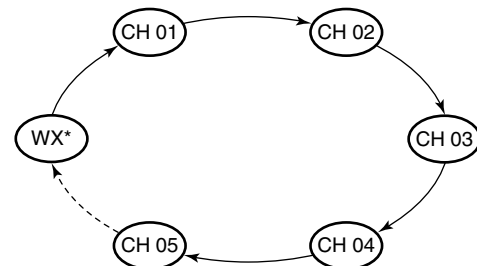

* Previously selected weather channel when weather alert function is ON.

Normal scan, like priority scan, searches through all TAG channels in sequence. However, unlike priority scan, Channel 16 is not checked unless Channel 16 is set as a TAG channel.

■ Setting TAG channels

For more efficient scanning, set the desired channels as TAG channels or clear the TAG setting from unwanted channels. Channels that are not tagged will be skipped during scanning. TAG channels can be assigned to each channel group (U.S.A., International and Canada) independently.

- ① Push and hold **[U/I/C]** (CH/WX) for 1 sec. several times to select the desired channel group, if desired.
- ② Select the desired channel to be set as a TAG channel.
- ③ Push and hold **[TAG]** (FAV) for 1 sec. to set the displayed channel as a TAG channel.
 - “[TAG]” appears in the function display.
- ④ To cancel the TAG channel setting, push and hold **[TAG]** (FAV) for 1 sec.
 - “[TAG]” disappears.

✓ Clearing (or setting) all tagged channels

While pushing and holding **[TAG]** (FAV), turn power ON to clear all TAG channels in the selected channel group.

- Repeat above procedure to set all channels as TAG channels (when no TAG channel has been set.)

■ Starting a scan

Set the weather alert function, priority scan function, scan resume timer and auto scan function in advance, using set mode. (pgs. 18, 19)

- ① Push and hold **[U/I/C]** (CH/WX) for 1 sec. several times to select the desired channel group, if desired.
 - When the weather alert function is in use, select the desired weather channel with **[CH/WX]** and **[▲]/[▼]**.
- ② Push **[SCAN]** to start priority or normal scan.
 - “SCAN” blinks in the function display.
 - “16” appears on the sub channel readout during priority scan.
 - When a signal is received, scan pauses until the signal disappears or resumes after pausing 5 sec. according to the scan resume timer setting. (Channel 16 is still monitored during priority scan.)
 - Push **[▲]/[▼]** to check which channels have been set as TAG channels, change the scanning direction or resume the scan manually.
- ③ To stop the scan, push **[SCAN]**.
 - “SCAN” disappears.
 - Pushing **[PTT]**, **[16]**, **[CH/WX]** or **[FAV]** also stops the scan.

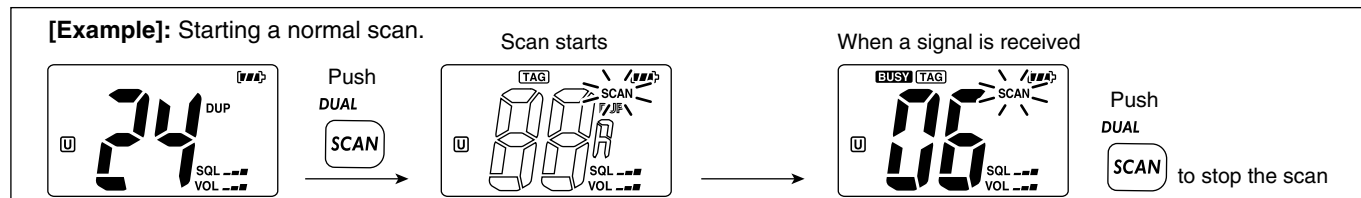

■ Description

Dualwatch monitors Channel 16 while you are receiving on another channel; Tri-watch monitors Channel 16 and the call channel while receiving another channel. Dualwatch/Tri-watch is convenient for monitoring Channel 16 when you are operating on another channel.

DUALWATCH/TRI-WATCH SIMULATION

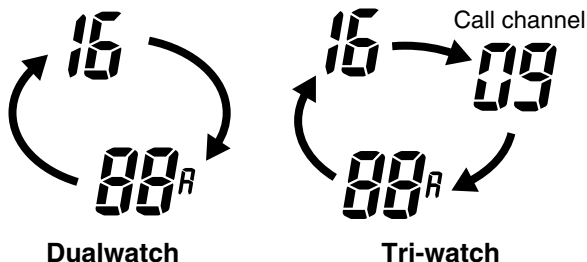

- If a signal is received on Channel 16, dualwatch/tri-watch pauses on Channel 16 until the signal disappears.
- If a signal is received on the call channel during Tri-watch, Tri-watch becomes Dualwatch until the signal disappears.
- To transmit on the selected channel during Dualwatch/Tri-watch, push and hold **[PTT]**.

■ Operation

- ① Select Dualwatch or Tri-watch in set mode. (p. 19)
- ② Select the desired channel.
- ③ Push and hold **[DUAL]** (SCAN) for 1 sec. to start Dualwatch or Tri-watch (depending on set mode setting).
 - “**DUAL**” blinks during dualwatch; “**TRI**” blinks during tri-watch.
 - A beep tone sounds when a signal is received on Channel 16.
 - Tri-watch becomes dualwatch when receiving a signal on the call channel.
- ④ To cancel dualwatch/tri-watch, push **[SCAN]** again.

[Example]: Operating Tri-watch on INT channel 07.

Tri-watch starts.



Signal is received on call channel.

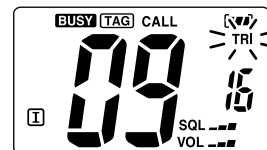

Tri-watch resumes after the signal disappears.

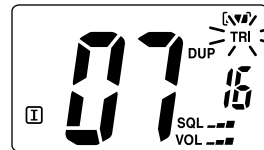

Signal received on Channel 16 takes priority.

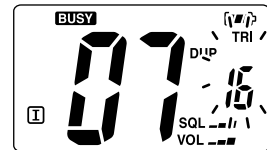

■ Set mode programming

Set mode is used to change the settings for 12 transceiver functions: beep tone function, weather alert function, priority scan function, scan resume timer, auto scan function, monitor key action, automatic backlighting, LCD contrast setting, power save function, squelch sensitivity and low fix function*.

*Appears only when the optional battery case is attached.

◇ Set mode operation

- ① Turn power OFF.
- ② While pushing **[SQL]**, turn power ON to enter set mode.
 - “bP” appears.
- ③ Push **[SQL]** or **[▲]/[▼]** while pushing and holding **[SQL]** to select the desired item, if necessary.
- ④ Push **[▲]/[▼]** to select the desired setting of the item.
- ⑤ To exit set mode, push **[16]**.

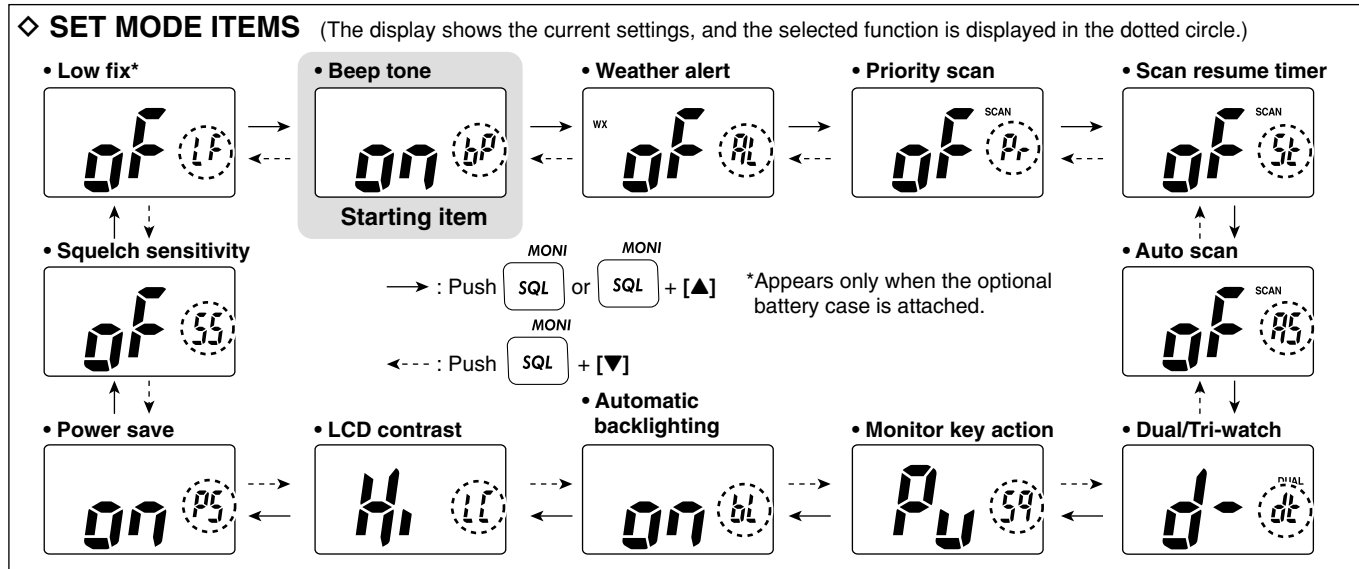

■ Set mode items

◇ Beep tone function “bP”

Select the key touch beep sound from ON or US, or turn sound OFF.

- US : The preset beeps (e.g. do, re, mi) sound
- ON : A fixed beep sounds (default)
- OFF : Silent operation



Beep tone ON (default)



Beep tone OFF

◇ Weather alert function “AL”

A NOAA broadcast station transmits a weather alert tone before any important weather announcements. When the weather alert function is turned ON and the transceiver detect the alert, “WX ALT” indicator blinks and a beep tone sounds. The blinking stops when the transceiver is operated.

The currently selected weather channel is checked when the power save function is turned ON or while scanning.

- “ALT” appears when the function is set ON.



Weather alert function OFF (default)



Weather alert function ON

◇ Priority scan function “Pr”

The transceiver has 2 scan types— normal (OFF) and priority (ON) scans. Normal scan searches all TAG channels in the selected channel group. Priority scan searches all TAG channels in sequence while monitoring Channel 16.



Normal scan (default)



Priority scan

◇ Scan resume timer “St”

The scan resume timer can be set as a pause (OFF) or timer scan (ON). When OFF is selected, the scan pauses until a received signal disappears. When ON is selected, the scan pauses for 5 sec. after receiving a signal and then resumes even if the signal is being received.

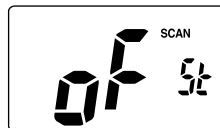

Scan resume timer OFF (default)

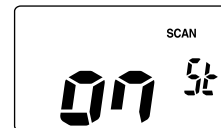

Scan resume timer ON

◇ **Auto scan function**

“AS”

The auto scan function starts the desired scan automatically when no signal is received, and no operation is performed for 30 sec.



Auto scan OFF (default)



Auto scan ON

◇ **Dual/Tri-watch function**

“dt”

This item selects dual or tri-watch as desired. See p. 16 for details.

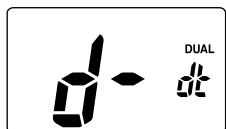

Dualwatch function
(default)

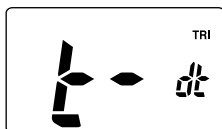

Tri-watch function

◇ **Monitor key action**

“Sq”

The monitor key opens the squelch temporarily. This key action contains PUSH (Pu) or HOLD (Ho) settings as shown below.

- Pu (PUSH): After pushing [MONI] (SQL) for 1 sec., the squelch opens and emits audio. The squelch is held open while continuously pushing and holding [MONI] (SQL). (default)
- Ho (HOLD): After pushing [MONI] (SQL) for 1 sec., the squelch opens and emits audio even while [MONI] (SQL) is released. To close the squelch, push any key.



Push setting (default)



Hold setting

◇ **Automatic Backlighting**

“bL”

This function is convenient for nighttime operation. The backlight can be selected from ON and OFF.

- The backlight is automatically activated when any key except for [PTT] is pushed.
- The backlight is automatically turned OFF after 5 sec. of inactivity.



Auto backlighting ON
(default)



Auto backlighting OFF

7 SET MODE

◇ LCD contrast setting

“LC”

Set the LCD contrast level from High contrast or Low contrast.

▨ **NOTE:** The LCD contrast level between High contrast and Low contrast makes no difference indoors.

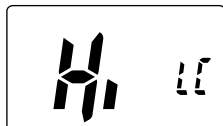

High contrast (default)



Low contrast

◇ Power save function

“PS”

The power save function reduces current drain by deactivating the receiver circuit for preset intervals.

- ON : The power save function is turned ON. The power save function will activate when no signal is received, and no operation is performed for 5 sec.
- OFF : The power save function is turned OFF.



Power save ON (default)



Power save OFF

◇ Squelch sensitivity

“SS”

When this function is turned ON, rejection of noise is improved so that the squelch is not easily affected by noise.



Squelch sensitivity OFF (default)



Squelch sensitivity ON

◇ Low fix function

“LF”

(Appears only when the optional battery case is attached.)

When this function is turned ON, the output power is fixed to low except for channel 16.



Low fix function OFF (default)



Low fix function ON

■ Battery caution

Misuse of Lithium-Ion batteries may result in the following hazards: smoke, fire, or the battery may rupture. Misuse can also cause damage to the battery or degradation of battery performance.

⚠ **DANGER!** Use and charge only specified Icom battery pack with Icom radios or Icom charger. Only Icom battery pack is tested and approved for use and charge with Icom radios or Icom charger. Using third-party or counterfeit battery packs or charger may cause smoke, fire, or cause the battery to burst.

◆ Battery caution

⚠ **DANGER! DO NOT** hammer or otherwise impact the battery. Do not use the battery if it has been severely impacted or dropped, or if the battery has been subjected to heavy pressure. Battery damage may not be visible on the outside of the case. Even if the surface of the battery does not show cracks or any other damage, the cells inside the battery may rupture or catch fire.

⚠ **DANGER! NEVER** use or leave battery pack in areas with temperatures above +60°C (+140°F). High temperature buildup in the battery, such as could occur near fires or stoves, inside a sun-heated car, or by setting the battery in direct sunlight may cause the battery to rupture or catch fire. Excessive temperatures may also degrade battery performance or shorten battery life.

⚠ **DANGER! DO NOT** expose the battery to rain, snow, seawater, or any other liquids. Do not charge or use a wet battery. If the battery gets wet, be sure to wipe it dry before using. The battery by itself is not waterproof.

⚠ **DANGER! NEVER** incinerate a used battery pack since internal battery gas may cause them to rupture or may cause an explosion.

⚠ **DANGER! NEVER** solder the battery terminals, or **NEVER** modify the battery pack. This may cause heat generation, and the battery may rupture, emit smoke or catch fire.

⚠ **DANGER!** Use the battery only with the transceiver for which it is specified. Never use a battery with any other equipment, or for any purpose that is not specified in this instruction manual.

⚠ **DANGER!** If fluid from inside the battery gets in your eyes, blindness can result. Rinse your eyes with clean water, without rubbing them, and see a doctor immediately.

8 BATTERY CHARGING

WARNING! Immediately stop using the battery if it emits an abnormal odor, heats up, or is discolored or deformed. If any of these conditions occur, contact your Icom dealer or distributor.

WARNING! Immediately wash, using clean water, any part of the body that comes into contact with fluid from inside the battery.

WARNING! NEVER put the battery in a microwave oven, high-pressure container, or in an induction heating cooker. This could cause overheating, a fire, or cause the battery to rupture.

CAUTION! Always use the battery within the specified temperature range for the transceiver (-20°C to $+60^{\circ}\text{C}$; -4°F to $+140^{\circ}\text{F}$) and the battery itself (-20°C to $+60^{\circ}\text{C}$; -4°F to $+140^{\circ}\text{F}$). Using the battery out of its specified temperature range will reduce the battery's performance and battery life.

CAUTION! Shorter battery life could occur if the battery is left fully charged, completely discharged, or in an excessive temperature environment (above $+50^{\circ}\text{C}$; $+122^{\circ}\text{F}$) for an extended period of time. If the battery must be left unused for a long time, it must be detached from the radio after discharging. You may use the battery until the battery indicator shows half-capacity (), then keep it safely in a cool dry place with the temperature between -20°C to $+20^{\circ}\text{C}$ (-4°F to $+68^{\circ}\text{F}$).

◇ Charging caution

⚠ **DANGER! NEVER** charge the battery pack in areas with extremely high temperatures, such as near fires or stoves, inside a sun-heated car, or in direct sunlight. In such environments, the safety/protection circuit in the battery will activate, causing the battery to stop charging.

WARNING! DO NOT charge or leave the battery in the battery charger beyond the specified time for charging. If the battery is not completely charged by the specified time, stop charging and remove the battery from the battery charger. Continuing to charge the battery beyond the specified time limit may cause a fire, overheating, or the battery may rupture.

WARNING! NEVER insert the battery and transceiver (battery attached to the transceiver) into the charger if it is wet or soiled. This could corrode the battery charger terminals or damage the charger. The charger is not waterproof.

CAUTION! DO NOT charge the battery outside of the specified temperature range: $\pm 0^{\circ}\text{C}$ to $+40^{\circ}\text{C}$ ($+32^{\circ}\text{F}$ to $+104^{\circ}\text{F}$). Icom recommends charging the battery at $+20^{\circ}\text{C}$ ($+68^{\circ}\text{F}$). The battery may heat up or rupture if charged out of the specified temperature range. Additionally, battery performance or battery life may be reduced.

■ Supplied battery charger

◇ Charging connections

⚡ Do not charge batteries other than the BP-252.

- ① Attach the BC-173 to a flat surface, such as a desk, if desired.
- ② Connect the AC adapter as shown below.
- ③ Insert the battery pack with/without the transceiver into the charger.
 - The charge indicator lights orange.
 - The charge indicator blinks orange (or orange/green alternately) when the protector is activated.
- ④ Charge the battery pack approx. 10 hours, depending on the remaining battery charge.
 - The charge indicator lights green when charging is completed.

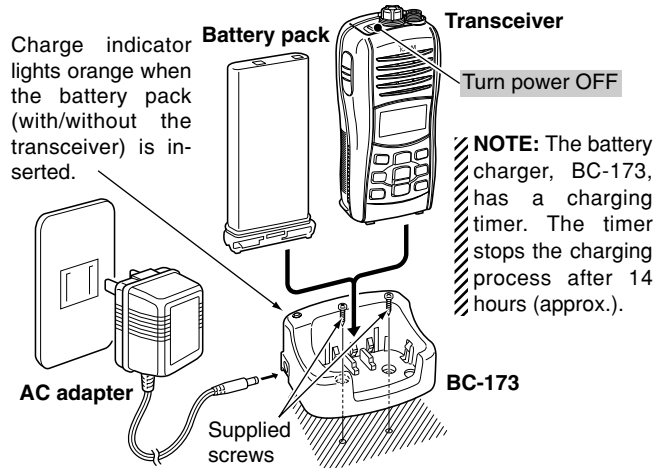

■ Optional battery case

When you would like to use the optional AAA(LR03) size battery case (BP-251), install the batteries as illustrated below. Be sure to observe the correct polarity.

CAUTION:

- When installing batteries, make sure they are all the same brand, type and capacity. Also, do not mix new and old batteries together.
- Keep battery contacts clean. It's a good idea to clean battery terminals once a week.
- When using the optional battery case, output power level is 2 W (at high).

NOTE: The transceiver may sink when the optional battery case is attached. (Depends on the weight of the installed batteries.)

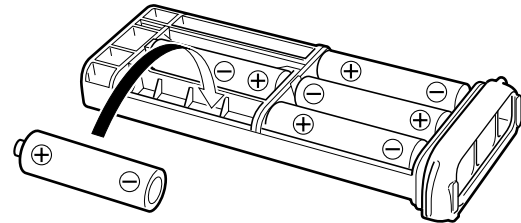

■ Optional battery charger

◇ BC-162 installation

• To a desktop

Supplied screws

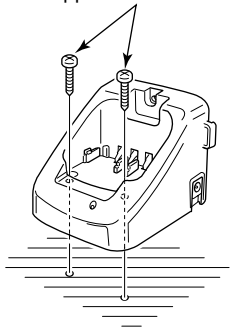

• To a wall

Supplied screws

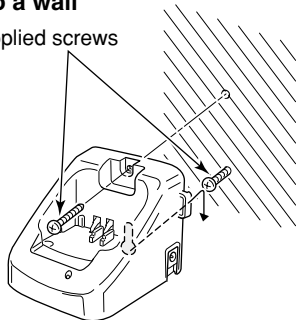

• For added stability

Eyelet:

Use a rubber band to secure the transceiver, if desired.

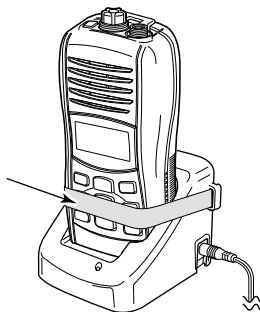

◇ Charging

- ① Connect the AC adapter as shown below.
- ② Insert the battery pack with/without the transceiver into the charger.
 - The charge indicator lights orange.
 - The charge indicator blinks orange (or red) when the protector is activated.
- ③ Charge the battery pack approx. 2 hours, depending on the remaining battery charge.
 - The charge indicator lights green when charging is completed.

NOTE: The battery charger, BC-162, has a charging timer. The timer stops the charging process after 4 hours (approx.).

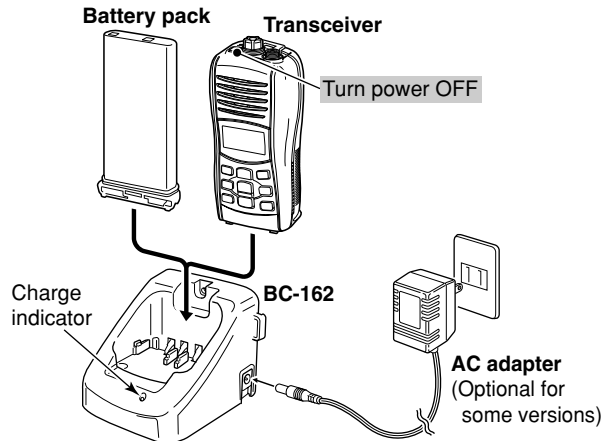

■ HM-165 descriptions

Alligator type clip

To attach the speaker-mic. to your shirt or collar, etc.

PTT switch

Transmits during push.
Receives during release.

Microphone

Speaker

Turn the transceiver power OFF when connecting the HM-165.

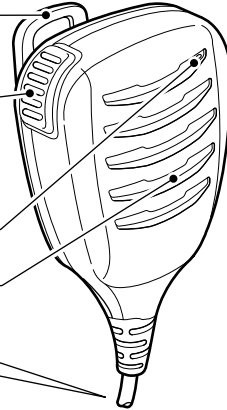

NEVER immerse the connector in water. If the connector becomes wet, be sure to dry it **BEFORE** attaching it to the transceiver.

NOTE: The microphone is located at the top of the speaker-microphone, as shown in the diagram above. To maximize the readability of your transmitted signal (voice), hold the microphone approx. 2.5 cm (1 inch) from your mouth, and speak in a normal voice level.

■ Attachment

Turn power OFF before attaching the speaker-microphone. Then, insert the speaker-mic connector onto the [SP MIC] connector and carefully screw it tight, as shown in the diagram below. Be careful not to cross-thread the connection.

IMPORTANT: KEEP the transceiver's [SP MIC] connector cap attached when the speaker-microphone is not in use. If the cover is not attached, water will get into the transceiver. Moreover, the terminals (pins) will become rusty, or the transceiver will function abnormally if the connector has become wet.

CAUTION: Attach the speaker-microphone's connector securely to prevent accidental loss, or water intrusion in the connector.

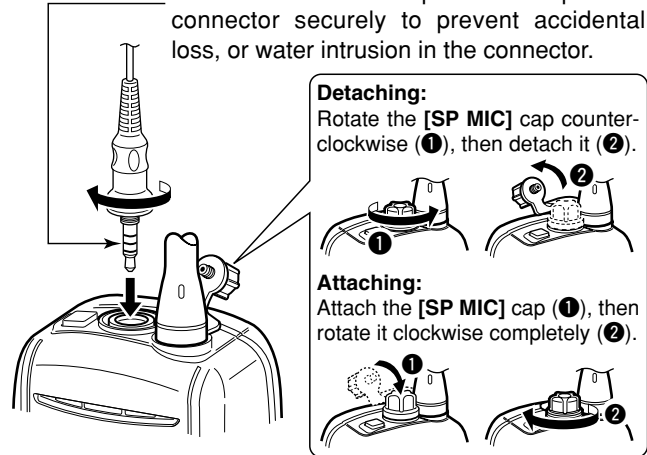

10 TROUBLESHOOTING

PROBLEM	POSSIBLE CAUSE	SOLUTION	REF.
The transceiver does not turn ON.	<ul style="list-style-type: none"> • The battery is exhausted. • The battery pack is not attached correctly. 	<ul style="list-style-type: none"> • Recharge the battery pack. • Attach the battery pack correctly. 	<p>p. 23 p. 3</p>
No sound from speaker.	<ul style="list-style-type: none"> • Squelch level is too high. • Volume level is too low. • Speaker has been exposed to water. 	<ul style="list-style-type: none"> • Set squelch to the threshold point. • Push [▲]/[▼] after pushing [VOL] to set a suitable level. • Drain water from the speaker. 	<p>p. 12 p. 11 p. 13</p>
Transmitting is impossible, or high power can not be selected.	<ul style="list-style-type: none"> • Some channels are for low power or receive only. • The battery is exhausted. • The battery over charged. • The output power is set to low. 	<ul style="list-style-type: none"> • Change channels. • Recharge the battery pack. • Verify the battery voltage is correct. • Push [H/L] to select high power. 	<p>pgs. 8, 9, 27 p. 23 — p. 10</p>
The displayed channel cannot be changed.	<ul style="list-style-type: none"> • Lock function is activated. 	<ul style="list-style-type: none"> • Push and hold [LOCK] (H/L) for 1 sec. to cancel the function. 	p. 12
Scan does not start.	<ul style="list-style-type: none"> • "TAG" channels are not programmed. 	<ul style="list-style-type: none"> • Set the desired channels as "TAG" channels. 	p. 15
No beeps.	<ul style="list-style-type: none"> • Beep tone function is turned OFF. 	<ul style="list-style-type: none"> • Set the beep tone to ON (Fix Beep/User Beep) in set mode. 	p. 18
Battery voltage error	<ul style="list-style-type: none"> • The connected battery pack's voltage is more than 11 V. 	<ul style="list-style-type: none"> • Verify the battery voltage is correct. 	—

12 SPECIFICATIONS

◇ GENERAL

- Frequency coverage : Transmit 156.025–157.425 MHz
Receive 156.050–163.275 MHz
- Mode : FM (16K0G3E)
- Channel spacing : 25 kHz
- Power supply requirement : BP-251 and BP-252 only
- Current drain (at 7.4 V DC) : TX High (5 W) 1.5 A
TX Low (1 W) 0.7 A
Max. audio 0.2 A
Power save 20 mA typical
- Frequency stability : ± 10 ppm (-20°C to $+60^{\circ}\text{C}$)
- Useable temperature range : -20°C to $+60^{\circ}\text{C}$; -4°F to $+140^{\circ}\text{F}$
- Dimensions : 62 (W) \times 141.5 (H) \times 43 (D) mm
(Projections not included) $2\frac{7}{16}$ (W) \times $5\frac{9}{16}$ (H) \times $1\frac{11}{16}$ (D) inch
- Weight : Approx. 305 g (10.7 oz)
(with BP-252, FA-SC58V and MB-109)

◇ TRANSMITTER

- Output power (at 7.4 V DC) : 5 W (High) and 1 W (Low)
- Modulation system : Variable reactance frequency modulation
- Max. frequency deviation : ± 5 kHz
- Adjacent channel power : 70 dB
- Spurious emissions : -68 dBc typical

◇ RECEIVER

- Receive system : Double-conversion superheterodyne
- Sensitivity (12 dB SINAD) : 0.25 μV typical
- Squelch sensitivity : 0.35 μV typical (at threshold)
- Intermodulation rejection ratio : 70 dB typical
- Spurious response rejection ratio : 70 dB typical
- Adjacent channel selectivity : 70 dB typical
- Audio output power : 0.35 W typical at 10% distortion with an $8\ \Omega$ load

All stated specifications are subject to change without notice or obligation.

◇ BATTERY CASE AND PACK

- **BP-251** BATTERY CASE
Battery case for 5 × AAA (LR03) alkaline cells.
Output power level: 2 W
- **BP-252** Li-Ion BATTERY PACK
7.4 V/980 mAh Li-Ion battery pack.

◇ CHARGERS

- **BC-173** DESKTOP CHARGER + **BC-174A/E** AC ADAPTER
Used for regular charging of battery pack. An AC adapter is supplied with the charger depending on versions.
Charging time: approx. 10 hours
- **BC-162** DESKTOP CHARGER + **BC-145*** AC ADAPTER
Used for rapid charging of battery pack.
Charging time: approx. 2 hours.
*Not supplied with some versions.

◇ BELT CLIPS

- **MB-109** BELT CLIP
The same as supplied with the transceiver.

◇ OTHER OPTIONS

- **HM-165** SPEAKER-MICROPHONE
Full sized waterproof (IPX7; 1m/30 min.) speaker-microphone. Includes an alligator clip to attach the speaker mic to your shirt, collar, etc.
- **FA-SC58V** ANTENNA FOR IC-M34

Count on us!

A-6544H-1EX
Printed in Japan
© 2006 Icom Inc.

Printed on recycled paper with soy ink.

Icom Inc.

1-1-32 Kamiminami, Hirano-ku, Osaka 547-0003, Japan