

ICOM[®]

**SERVICE
MANUAL**

VHF TRANSCEIVER

IC-2200H

Icom Inc.

INTRODUCTION

This service manual describes the latest service information for the **IC-2200H** VHF TRANSCEIVER at the time of publication.

MODEL	VERSION	SYMBOL
IC-2200H	Europe	EUR
	Taiwan	TPE
	U.S.A.	USA
	Korea	KOR
	Export	EXP
	Europe-1	EUR-1
	Export-1	EXP-1

DANGER

NEVER connect the transceiver to an AC outlet or to a DC power supply that uses more than 16 V. This will ruin the transceiver.

DO NOT expose the transceiver to rain, snow or any liquids.

DO NOT reverse the polarities of the power supply when connecting the transceiver.

DO NOT apply an RF signal of more than 20 dBm (100 mW) to the antenna connector. This could damage the transceiver's front end.

To upgrade quality, any electrical or mechanical parts and internal circuits are subject to change without notice or obligation.



ORDERING PARTS

Be sure to include the following four points when ordering replacement parts:

- 10-digit order numbers
- Component part number and name
- Equipment model name and unit name
- Quantity required

<SAMPLE ORDER>

1130008350 S.IC LV2105V IC-2200H MAIN UNIT 5 pieces
 8810009610 Screw FH M2.6x6 ZK IC-2200H Cover 10 pieces
 Addresses are provided on the inside back cover for your convenience.

REPAIR NOTES

1. Make sure a problem is internal before disassembling the transceiver.
- DO NOT** open the transceiver until the transceiver is disconnected from its power source.
- DO NOT** force any of the variable components. Turn them slowly and smoothly.
- DO NOT** short any circuits or electronic parts. An insulated tuning tool **MUST** be used for all adjustments.
- DO NOT** keep power ON for a long time when the transceiver is defective.
- DO NOT** transmit power into a signal generator or a sweep generator.
- ALWAYS** connect a 40 dB to 50 dB attenuator between the transceiver and a deviation meter or spectrum analyzer when using such test equipment.
- READ** the instructions of test equipment thoroughly before connecting equipment to the transceiver.

Icom, Icom Inc. and **ICOM** are registered trademarks of Icom Incorporated (Japan) in the United States, the United Kingdom, Germany, France, Spain, Russia and/or other countries.

TABLE OF CONTENTS

SECTION 1	SPECIFICATIONS	
SECTION 2	INSIDE VIEWS	
2 - 1	IC-2200H	2 - 1
2 - 2	HM-133V	2 - 2
SECTION 3	OPTIONAL UNIT INSTALLATION	
SECTION 4	CIRCUIT DESCRIPTION	
SECTION 5	ADJUSTMENT PROCEDURES	
SECTION 6	PARTS LIST	
SECTION 7	MECHANICAL PARTS AND DISSASSEMBLY	
7 - 1	IC-2200H	7 - 1
7 - 2	HM-133V	7 - 1
SECTION 8	SEMI-CONDUCTOR INFORMATION	
SECTION 9	BOARD LAYOUTS	
9 - 1	LOGIC UNIT	9 - 1
9 - 2	MAIN UNIT	9 - 3
9 - 3	HM-133V	9 - 5
9 - 4	HM-118TN	9 - 7
SECTION 10	BLOCK DIAGRAMS	
10 - 1	IC-2200H	10 - 1
10 - 2	HM-133V	10 - 2
SECTION 11	VOLTAGE DIAGRAMS	
11 - 1	LOGIC UNIT	11 - 1
11 - 2	MAIN UNIT	11 - 2
11 - 3	HM-133V	11 - 3
SECTION 12	HM-118/N (OPTIONAL UNIT)	
12 - 1	INSIDE VIEW	12 - 1
12 - 2	BOARD LAYOUTS	12 - 1
12 - 3	MECHANICAL PARTS LIST AND DISSASSEMBLY	12 - 2
SECTION 13	UT-108 (OPTIONAL UNIT)	
13 - 1	BOARD LAYOUT	13 - 1
SECTION 14	UT-115 (OPTIONAL UNIT)	
14 - 1	BOARD LAYOUT	14 - 1
14 - 2	SEMI-CONDUCTOR INFORMATION	14 - 2
14 - 3	BLOCK DIAGRAM	14 - 2
14 - 4	VOLTAGE DIAGRAM	14 - 3

SECTION 1 SPECIFICATIONS

■ GENERAL

- Frequency range :

Version	Receive (MHz)	Transmit (MHz)
[EUR]	118.000 – 174.000* ¹	144.000 – 146.000
[USA]	118.000 – 174.000* ²	144.000 – 148.000
[EXP], [EXP-1]	118.000 – 174.000* ²	136.000 – 174.000* ²
[EUR-1], [TPE], [KOR]	144.000 – 146.000	144.000 – 146.000

*¹Specifications guaranteed 144.000 – 146.000 MHz only

*²Specifications guaranteed 144.000 – 148.000 MHz only

- Mode : FM, AM (Receive only)
- Number of memory channel : 206 (include in 6 band edges memory and 1 call channel)
- Usable temperature range : -10°C to +60°C; +14°F to +140°F
- Scan type : Full, Program, Priority, Memory channel, Bank, Skip and Tone scans
- Frequency resolution : 5, 10, 12.5, 15, 20, 25, 30 and 50 kHz
- Frequency stability : ±10 ppm (-10°C to +60°C; +14°F to +140°F)
- Power supply requirement : 13.8 V DC ±15 % (negative ground)
- Current drain (at 13.8 V DC) :

Receive	Standby (squelched)	0.8 A
	Max. audio	1.0 A
Transmit	at 65 W or 50 W	15.0 A (except [TPE])
	at 25 W	9.0 A
	at 24 W	10.0 A ([TPE] only)
	at 10 W	6 A (except [TPE])
	at 5 W	5 A
- Antenna connector : SO-239 (50 Ω)
- Dimensions : 140(W)×40(H)×146(D) mm;
(projections not included) 5½(W)×1⅞(H)×5¾(D) inch
- Weight : Approx. 1.25 kg; 2 lb 12 oz

■ TRANSMITTER

- Output power :

Version	High	Middle-high	Middle-low	Low
except [TPE], [KOR]	65 W	25 W	10 W	5 W
[KOR]	50 W	25 W	10 W	5 W
[TPE]	24 W	10 W	–	5 W

- Modulation system : Variable reactance frequency
- Maximum frequency deviation : ±5.0/±2.5* kHz *except [EXP-1]
- Spurious emissions : Less than -60 dBc
- Microphone connector : 8-pin modular (600 Ω)

■ RECEIVER

- Receive system : Double-conversion superheterodyne
- Intermediate frequency : 1st 21.7 MHz
2nd 450 kHz
- Sensitivity (at 12 dB SINAD) : Less than 0.18 μV
- Squelch sensitivity (threshold) : Less than 0.13 μV
- Selectivity : (Wide) More than ±6 kHz at 6 dB, More than ±14 kHz at 60 dB
(Narrow)* More than ±3 kHz at 6 dB, More than ±9 kHz at 55 dB
*except [EXP-1]
- Spurious and image rejection : More than 60 dB
- Audio output power (at 13.8 V) : More than 2.4 W at 10% distortion with an 8Ω load
- External speaker connector : 2-conductor 3.5(d) mm (1⅛")/8Ω

All stated specifications are subject to change without notice or obligation.

• UT-115 SPECIFICATIONS

■ GENERAL

- Usable temperature range : -10°C to $+60^{\circ}\text{C}$; $+14^{\circ}\text{F}$ to $+140^{\circ}\text{F}$
- Power supply requirement : 5.0 V DC
(4.5 V–8.5 V for AMBE IC VCC line)
- AF input level : 1 V_{p-p} typical
- Modulation output level : 350 mV_{p-p} typical
- Demodulation input level : 500 mV_{p-p} typical
- AF output level : 750 mV_{p-p} typical
- CODEC type : AMBE
- Transfer speed : 4.8 kbps
- Control signal input voltage : 3.0 V–5.0 V for High
0 V for Low
- Control signal output voltage : Open collector for High
0 V for Low
- Current drain (at 5.0 V DC) : 55 mA typical
- Dimensions : 30(W)×38(D) mm;
(projections not included) $1\frac{3}{16}$ (W)× $1\frac{1}{2}$ (D) inch
- Weight : Approx. 6 g; $\frac{7}{32}$ oz
(accessories not included)
- Connector : AXN430C330

All stated specifications are subject to change without notice or obligation.

SECTION 2 INSIDE VIEWS

2-1 IC-2200H

• MAIN UNIT (TOP VIEW)

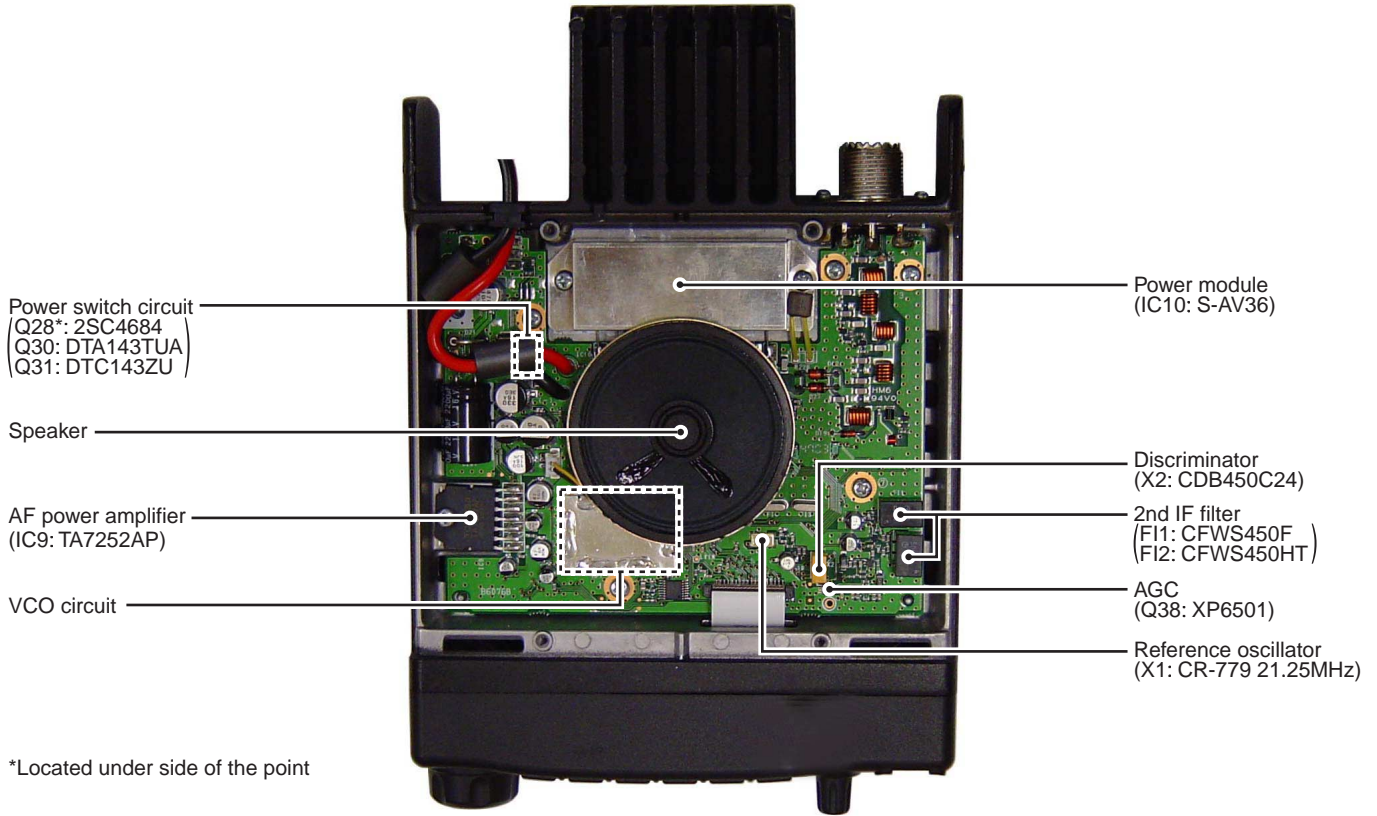

• MAIN UNIT (BOTTOM VIEW)

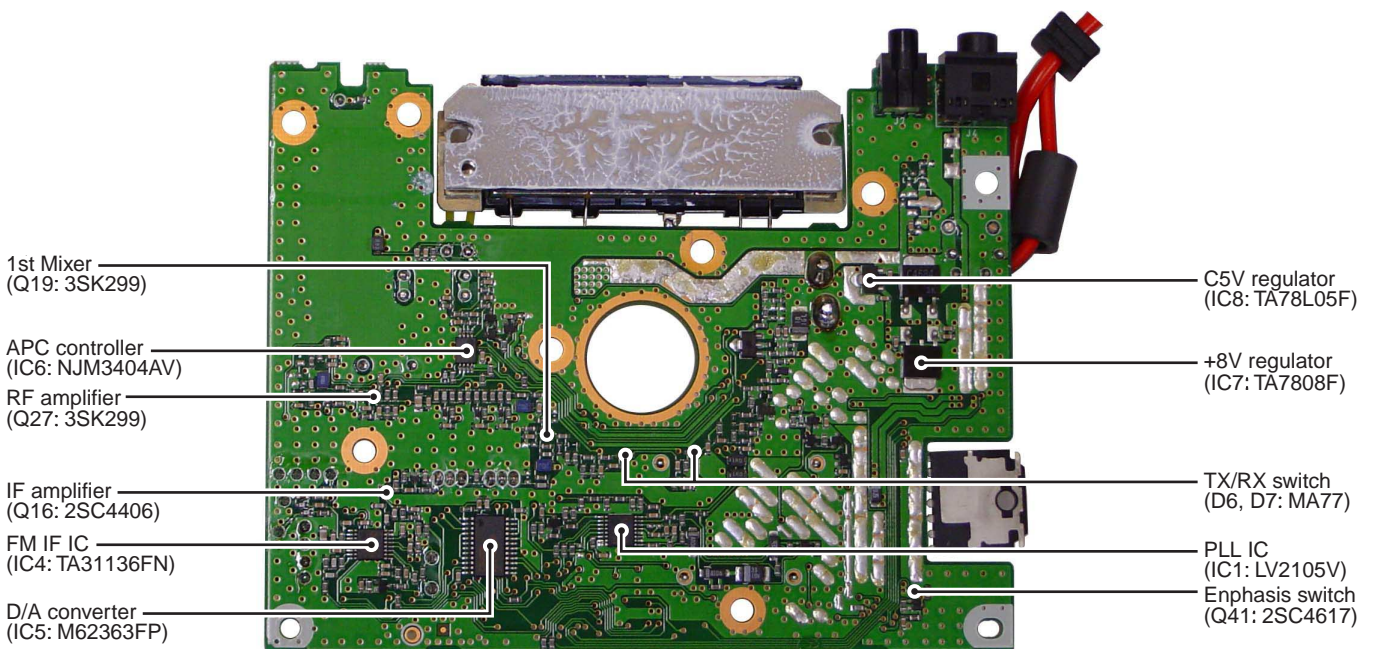

2-2 HM-133V

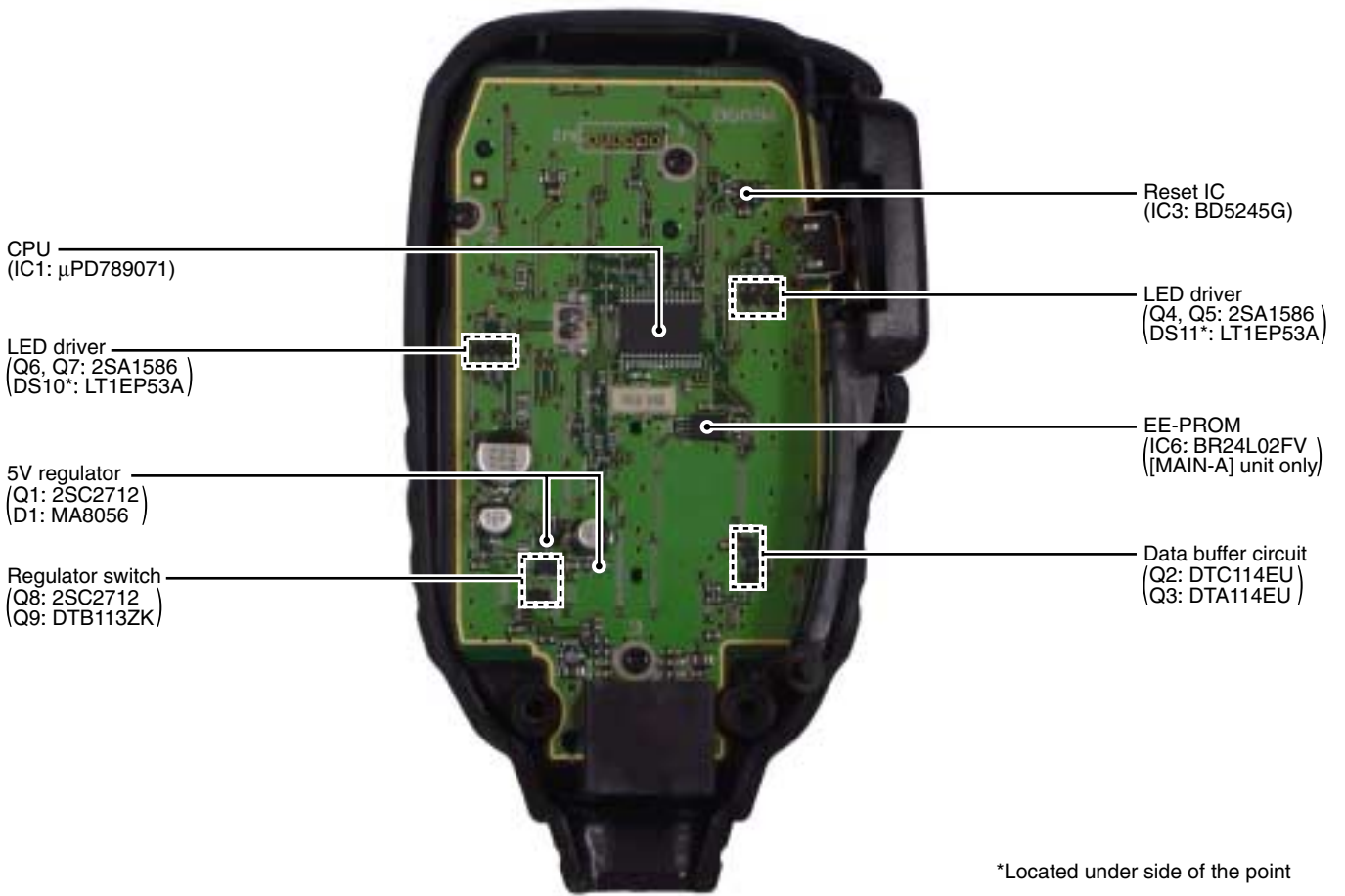

SECTION 3 OPTIONAL UNIT INSTALLATION

- ① Remove [DIAL] and unscrew the 2 allen-socket bolts from the front panel using with an allen wrench (2.5 mm; 1/16").

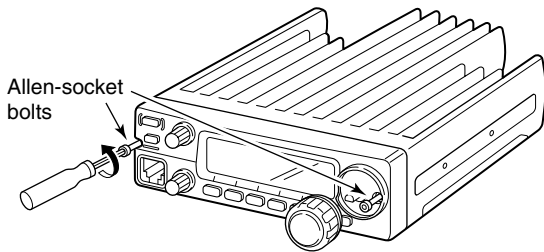

- ② Detach the front panel from the main unit.

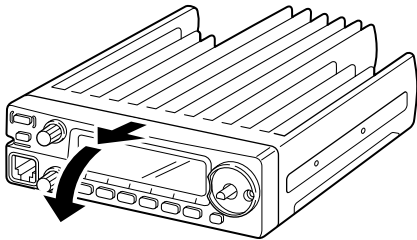

- ③ Attach the insulation sheet (supplied as accessory) to IC on the Front unit.
④ Remove the protective paper attached to the bottom of the optional unit to expose the adhesive strip.

- ⑤ Intall the unit as illustrated below. Insert tightly to avoid bad contact.

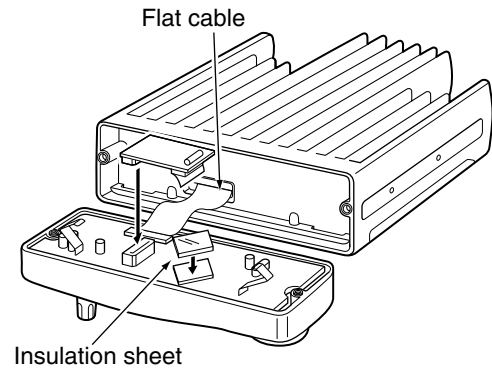

- ⑥ Return the front panel and the allen-socket bolts to their original position.

NOTE: When attaching the front panel to the main unit, make sure the flat cable are running in the groove to prevent catching between front panel and main unit.

SECTION 4 CIRCUIT DESCRIPTION

4-1 RECEIVER CIRCUITS

4-1-1 ANTENNA SWITCHING CIRCUIT (MAIN UNIT)

The antenna switching circuit functions as a low-pass filter while receiving and a resonator circuit while transmitting. The circuit does not allow transmit signals to enter receiver circuits.

Received signals enter the antenna connector and pass through the low-pass filter (L47, L48, C208, C210, C217). The filtered signals are passed through the $\lambda/4$ type antenna switching circuit (D16, D19, L45, L46) and limiter circuits (D15). The signals are then applied to the squelch attenuator circuit.

4-1-2 SQUELCH ATTENUATOR CIRCUIT (MAIN UNIT)

The attenuator circuit attenuates the signal strength to a maximum of 10 dB to protect the RF amplifier from distortion when excessively strong signals are received.

The current flow of the antenna switching circuit (D16, D19) is controlled by the [SQL] control via the attenuator controller (IC6a, D18). When the [SQL] control is rotated clockwise deeper than 12 o'clock, the current of D16 and D19 is increased. In this case, D16 and D19 act as an attenuator.

4-1-3 RF CIRCUIT (MAIN UNIT)

The RF circuit amplifies signals within the range of frequency coverage and filters out-of-band signals.

The signals from the squelch attenuator circuit pass through the tunable bandpass filter (D13). The filtered signals are amplified at the RF amplifier (Q27) and then enter another three-stage bandpass filters (D9–D11) to suppress unwanted signals. The filtered signals are applied to the 1st mixer circuit (Q19).

The tunable bandpass filters (D13–D16) employ varactor diodes to tune the center frequency of the RF passband for wide bandwidth receiving and good image response rejection. These diodes are controlled by the CPU (LOGIC unit; IC1) via the D/A convertor (IC5).

4-1-4 1ST MIXER AND 1ST IF CIRCUITS (MAIN UNIT)

The 1st mixer circuit converts the received signals to a fixed frequency of the 1st IF signal with the PLL output frequency. By changing the PLL frequency, only the desired frequency will pass through a pair of crystal filters at the next stage of the 1st mixer.

The RF signals from the bandpass filter are applied to the 1st mixer circuit (Q19). The applied signals are mixed with the 1st LO signal coming from the RX-VCO circuit (Q7, D5, D38) to produce a 21.7 MHz 1st IF signal. The 1st IF signal passes through a pair of crystal filters (F13, F14) to suppress out-of-band signals. The filtered signal is amplified at the 1st IF amplifier (Q16), and applied to the 2nd IF circuit via the limiter circuit (D29).

4-1-5 2ND IF AND DEMODULATOR CIRCUITS (MAIN unit)

The 2nd mixer circuit converts the 1st IF signal to a 2nd IF signal. A double-conversion superheterodyne system improves the image rejection ratio and obtains stable receiver gain.

The 1st IF signal from the IF amplifier (Q16) is applied to the 2nd mixer section of the FM IF IC (IC4, pin 16) and is then mixed with the 2nd LO signal for conversion to a 450 kHz 2nd IF signal.

IC4 contains the 2nd mixer, limiter amplifier, quadrature detector, S-meter detector, active filter and noise amplifier circuits, etc. A frequency from the PLL reference oscillator is used for the 2nd LO signal (21.25 MHz).

• 2ND IF AND DEMODULATOR CIRCUIT

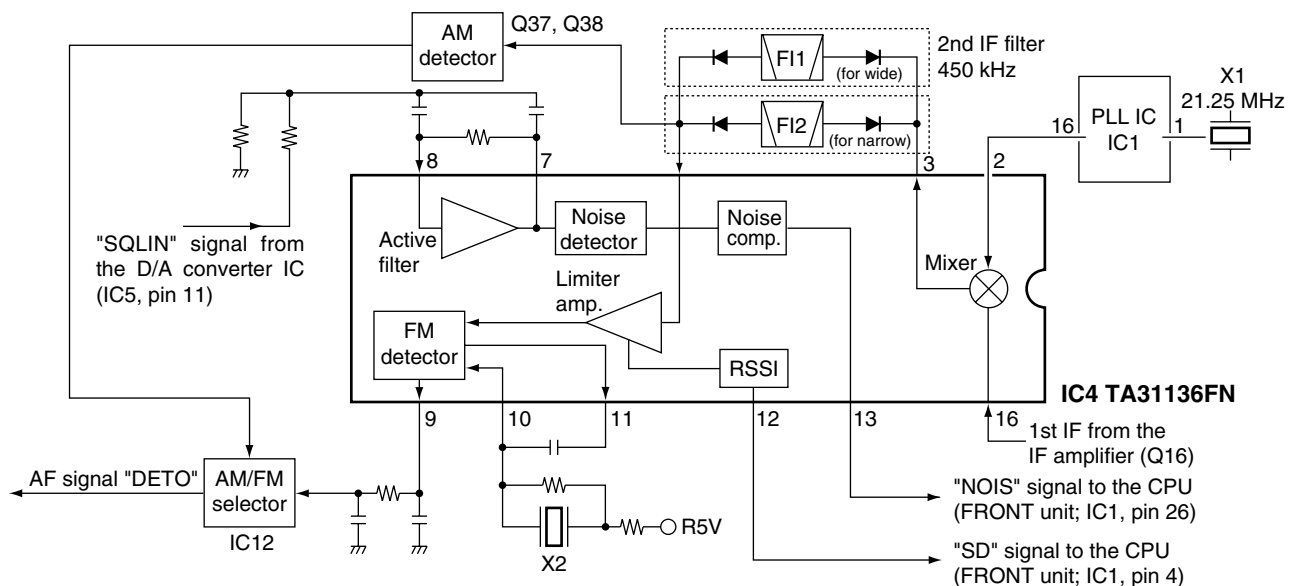

The 2nd IF signal from the 2nd mixer (IC4, pin 3) passes through the ceramic filter (FI1) (during wide channel spacing selection or passes through FI2 during narrow channel spacing selection; [W/N] only).

4-1-6 AM/FM SELECTOR CIRCUIT (MAIN UNIT)

IC-2200H can receive AM and FM signal. The 2nd IF signal is detected AM or FM detector circuits respectively.

(1) AM DETECTOR CIRCUIT

The filtered signal is applied to the AM detector circuit (Q37, Q38) to demodulate 2nd IF signal into AM AF signals. The AM AF signals are applied to the AF circuit via the AM/FM selector switch (IC12, pin 6).

(2) FM DETECTOR CIRCUIT

The filtered signal is amplified at the limiter amplifier section (IC4, pin 5), and is then applied to the quadrature detector section (IC4, pins 10, 11 and X2) to demodulate the 2nd IF signal into FM AF signals. The FM AF signals are output from pin 9 (IC4) and are then applied to the AF circuit via the AM/FM selector switch (IC12, pin 7).

4-1-7 AF CIRCUITS (LOGIC UNIT)

The AF circuits are composed of digital and analog AF circuits. The AF signals are amplified the demodulated AF signals to drive a speaker.

(1) IN CASE OF DIGITAL AF SIGNALS

The digital AF signals are applied to the optional digital unit (UT-115*) via the J4 (pin 23) by the "DETO" line. The audio signals that are converted to analog signals at the UT-115 are applied to the analog selector circuit (IC525, pin 8) from the optional digital voice unit passed through the J4 (pin 22) via the "AFOUT" line. The signals pass through the high-pass filter (IC3c, pins 8, 9) from the analog selector (IC525, pin 9), and are then applied to the analog switch (IC6, pin 1). *Refer to "4-6 UT-115 CIRCUIT DESCRIPTION" (page 4-7) in detail.

(2) IN CASE OF ANALOG AF SIGNALS

The analog AF signals are applied to the analog selector (IC525, pin 11), and pass through the high-pass filter (IC3c, pins 8, 9). The filtered signals are applied to the analog switch (IC6, pin 1).

The audio signals are applied to the AF mute switch (MAIN unit; Q29) via the VOL adjust pot (R61). The signals are amplified at the AF amplifier (MAIN unit; IC9, pin 1) to obtain 2.4 W audio output power after being passed through the emphasis switch (MAIN unit; Q41). The amplified AF signals are applied to the speaker via the J4 (MAIN unit) and J6 (MAIN unit).

4-1-8 SQUELCH CIRCUITS (MAIN AND LOGIC UNITS)

• NOISE SQUELCH

The noise squelch circuit cuts out AF signals when no RF signals are received. By detecting noise components in the AF signals, the squelch circuit switches the AF mute switch.

A portion of detected audio signals from the FM IF IC (IC4, pin 9) are applied to the active filter section of the IC (IC4, pin 8) as "SQLIN" signal, after passing through the D/A converter (IC5, pin 12). The active filter section of the IC amplifies and filters noise components. The filtered signals are applied to the noise detector section in the IC and output from pin 13 as the "NOIS" signal.

The "NOIS" signal from IC4 (pin 13) is applied to the CPU (LOGIC unit; IC1, pin 26). The CPU analyzes the noise condition and outputs "AFMUTE" and "FILC" signals via the I/O expander IC (LOGIC unit; IC2) to toggle the AF mute (Q29) and emphasis (Q41) switches.

Even when the squelch is closed, the AF mute switch (Q29) opens at the moment of emitting beep tones.

• TONE SQUELCH

The tone squelch circuit detects AF signals and opens the squelch only when receiving a signal containing a matching subaudible tone (CTCSS). When tone squelch is in use, and a signal with a mismatched or no subaudible tone is received, the tone squelch circuit mutes the AF signals even when noise squelch is open.

AF signals from the FM IF IC (IC4, pin 9) are applied to the AM/FM selector (IC12, pin 6 or 7), and then pass through the analog selector (LOGIC unit; IC525, pins 10, 11). The signals pass through the low-pass filter (LOGIC unit; Q3) to remove AF (voice) signals, and is applied to the CTCSS decoder inside the CPU (LOGIC unit; IC1, pin 1) via the "CTCIN" line to control the AF mute switch.

• AF CIRCUIT

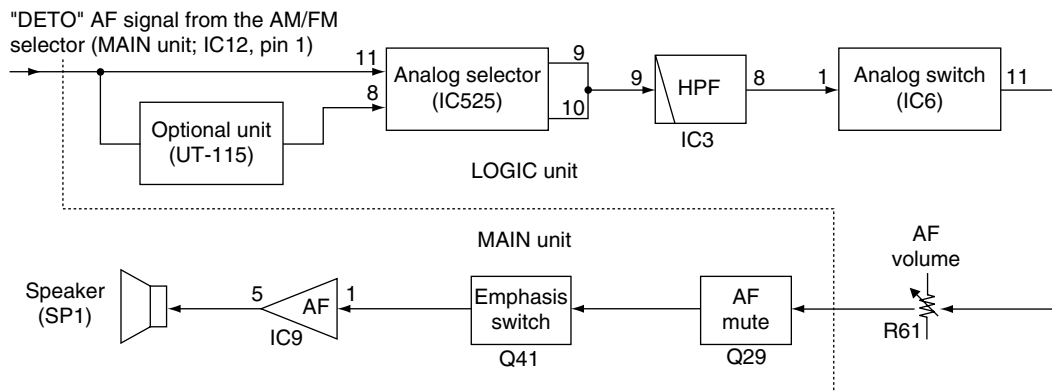

4-2 TRANSMITTER CIRCUITS

4-2-1 MICROPHONE AMPLIFIER CIRCUIT (LOGIC unit)

The microphone amplifier circuit amplifies audio signals with +6 dB/octave pre-emphasis characteristics from the microphone to a level needed for the modulation circuit.

The AF signals from the microphone pass through the microphone switch (IC2, D4), and are then amplified at the microphone amplifier (IC3a, pin 2). The amplified signals pass through (or bypass) the ALC circuit.

4-2-2 ALC CIRCUIT (LOGIC UNIT)

The ALC (Automatic Level Control) circuit reduces the gain of IF amplifiers in order for the transceiver to output a constant RF power set by the RF power setting even when the supplied voltage shifts, etc.

• IN CASE OF PASSING THROUGH THE ALC CIRCUIT

The amplified signals are applied to the ALC switch (IC520, pin 3), and are then output from pin 4. The signals are applied to the ALC amplifier (IC514, pin 3), and are then reapplied to the ALC switch (IC520, pin 8). The signals pass through the high-pass filter (IC3d, pins 12, 14), and are then applied to the analog switch (IC6, pin 4).

• IN CASE OF BYPASSING THE ALC CIRCUIT

The amplified signals are applied to the ALC switch (IC520, pin 2), and are then output from pin 1. The signals are applied to the ALC switch (IC520, pin 9) again, and then pass through the high-pass filter (IC3d, pins 12, 14) via the IC520, pin 10. The signals are applied to the analog switch (IC6, pin 4).

4-2-3 DIGITAL SWITCH CIRCUIT (LOGIC UNIT)

The signals from the analog switch (IC6, pin 3) pass through the high-pass filter (IC3, pins 6, 7), and are then reapplied to the analog switch (IC6, pin 9). The signals are applied to the DI/AN switch via the "MOD_I" line.

• IN CASE OF DIGITAL AF SIGNALS

The AF signals are applied to the DI/AN switch (IC522, pin 10), and are then applied to the optional digital voice unit after being passed through the J4 (pin 4) via the "ANALOGUE_MOD_IN" line. The A/D converted AF signals are applied to the DI/AN switch (IC522, pin 1) from the J4 (pin 3) via the "DIGITAL_MOD_OUT" line. The digital AF signals from DI/AN switch (IC522, pin 2) are applied to the modulation circuit after being passed through the J3 via the "MODIN" line.

• ALC CIRCUIT

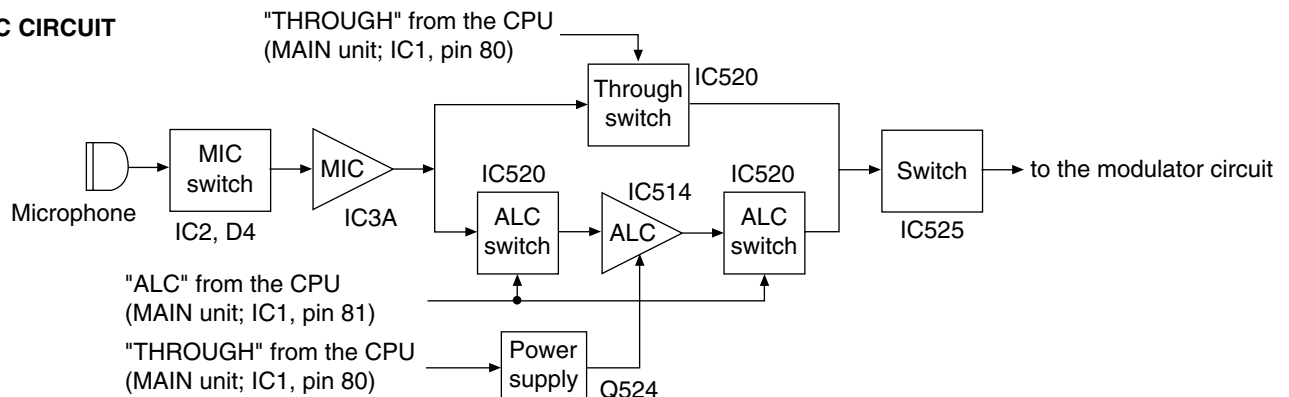

• IN CASE OF ANALOG AF SIGNALS

The AF signals are applied to the DI/AN switch (IC522, pin 9), and are then reapplied to the switch (pin 4) from pin 8. The signals output from the switch (pin 3) as analog AF signals, and are then applied to the modulation circuit after being passed through the J3 via the "MODIN" line.

4-2-4 MODULATION CIRCUIT (MAIN UNIT)

The modulation circuit modulates the VCO oscillating signal (RF signal) using the microphone audio signals.

The digital or analog audio signals (MODIN) change the reactance of D2 and D4 to modulate the oscillated signal at the TX-VCO circuit (Q6). The modulated signal is amplified at the LO amplifier (Q9) and buffer amplifier (Q11), then applied to the drive amplifiers.

4-2-5 DRIVE AMPLIFIER CIRCUIT (MAIN UNIT)

The drive amplifier circuit amplifies the VCO oscillating signal to the level needed at the power amplifier.

The RF signal from the buffer amplifier (Q11) passes through the T/R switch (D6) and is amplified at the pre-drive (Q17) and drive (Q35) amplifiers. The amplified signal is applied to the power amplifier circuit.

4-2-6 POWER AMPLIFIER CIRCUIT (MAIN UNIT)

The power amplifier circuit amplifies the driver signal to an output power level.

The RF signal from the drive amplifier (Q35) is applied to the power module (IC10) to obtain 65 W (50 W for Korea version, 25 W for Taiwan version) of RF power.

The amplified signals is passed through the antenna switching circuit (D12), APC detector circuit (D14, D17, L39), and low-pass filter (L47, L48, C208, C210, C217) and is then applied to the antenna connector.

Control voltage for the power amplifier (IC10, pin 2) are controlled by the APC circuit to protect the power module from a mismatched condition as well as to stabilize the output power.

4-2-7 APC CIRCUIT (MAIN UNIT)

The APC circuit protects the power amplifier from a mismatched output load and stabilizes the output power.

The APC detector circuit (D14, D17, L39) detects forward signals and reflection signals at D14 and D17 respectively. The combined voltage is at minimum level when the antenna impedance is matched at 50 Ω and is increased when it is mismatched.

The detected voltage is applied to the differential amplifier (IC6, pin 2), and the power setting voltage is applied to the other input (pin 1) for the reference.

When antenna impedance is mismatched, the detected voltage exceeds the power setting voltage. The output voltage of the differential amplifier (IC6, pin 1) controls the input current of the power module (IC10) to reduce the output power.

4-3 PLL CIRCUITS

4-3-1 PLL CIRCUIT

A PLL circuit provides stable oscillation of the transmit frequency and the receive 1st LO frequency. The PLL circuit compares the phase of the divided VCO frequency to the reference frequency. The PLL output frequency is controlled by the divided ratio (N-data) of a programmable divider.

An oscillated signal from the VCO passes through the LO and buffer amplifiers (Q9, Q12) is applied to the PLL IC (IC1, pin 6) and is prescaled in the PLL IC based on the divided ratio (N-data). The reference signal is generated at the reference oscillator (X1) and is also applied to the PLL IC. The PLL IC detects the out-of-step phase using the reference frequency and outputs it from pin 15. The output signal is passed through the loop filter (Q2, R6, R11–R15, C11, C12) and is then applied to the VCO circuit as the lock voltage via the “LV” line.

4-3-2 VCO CIRCUIT (MAIN unit)

The VCO circuit contains a separate TX-VCO (Q6, D2, D4) and RX-VCO (Q7, D5, D38). The oscillated signal is amplified at the LO (Q9) and buffer (Q11) amplifiers, and is then applied to the T/R switching circuit (D6, D7). Then the Tx and Rx signals are applied to the pre-driver (Q17) and 1st mixer (Q19) respectively.

A portion of the signal from Q4 is amplified at the buffer amplifier (Q6) and is then fed back to the PLL IC (IC1 pin 2) as the comparison signal.

• APC CIRCUIT

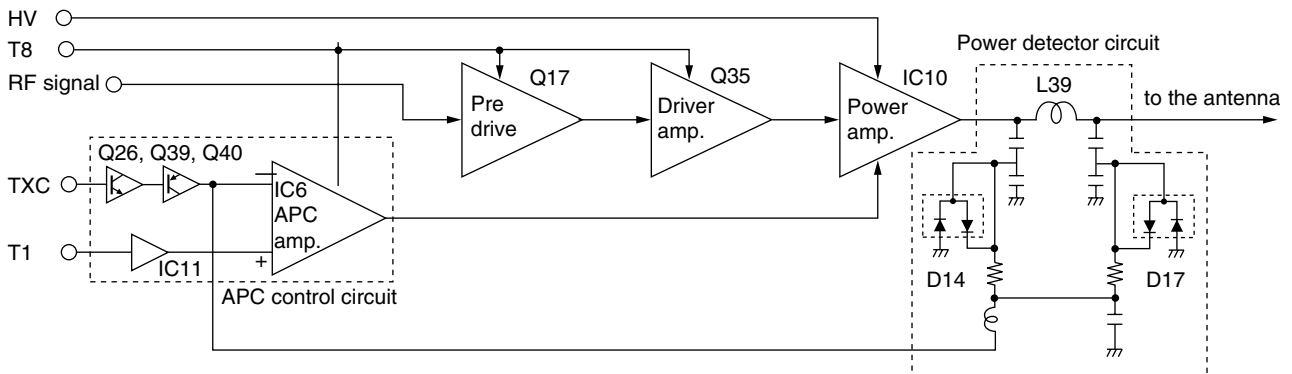

• PLL CIRCUIT

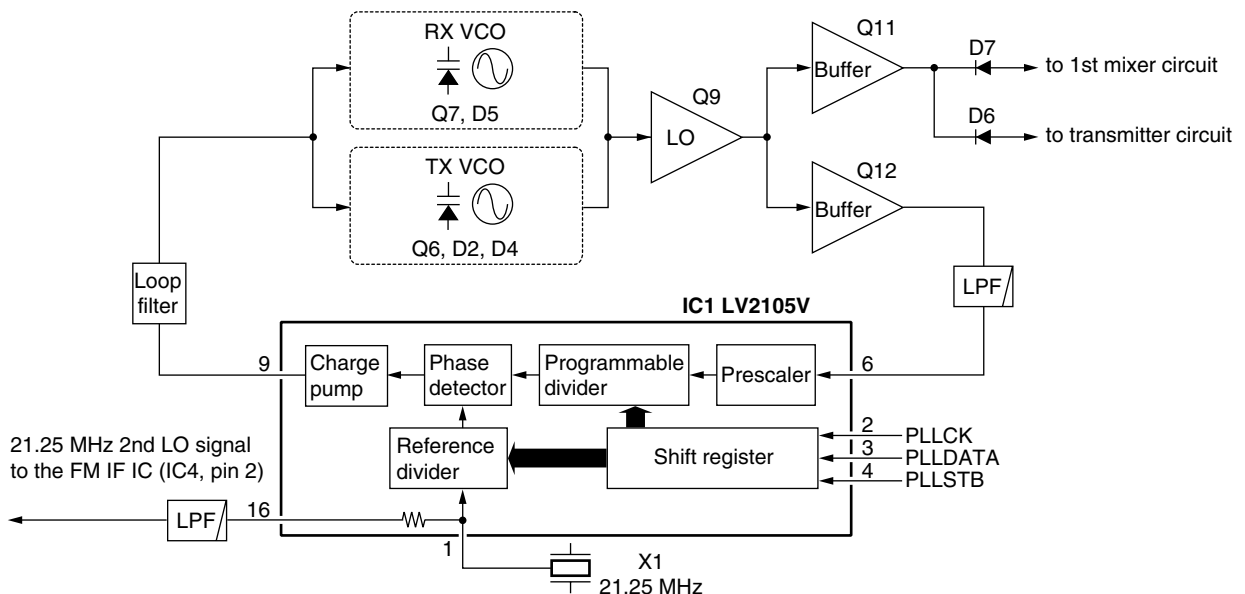

4-3-3 REFERENCE OSCILLATOR CONTROL CIRCUIT (LOGIC AND MAIN UNITS)

The reference oscillator control circuit changes the reference frequency when using digital voice function.

When digital voice signals output from the optional digital voice unit, the "REFMOD" signal outputs from it via the J4 (pin 4) at the same time. The "REFMOD" signal is applied to the amplifier (IC521, pin 3), and passes through the CTCSS switch (IC524, pins 6 and 1). The signal is applied to the D/A converter (MAIN unit; IC5, pin 13) via the "CTCSS" line. The output signal from the D/A converter (MAIN unit; IC5, pin 14) is applied to the reference oscillator (MAIN unit; X1) to control the reference frequency while transmitting digital signals as "DTC" line.

4-4 POWER SUPPLY CIRCUITS VOLTAGE LINES

Line	Description
HV	The 13.8 V voltage from the connected DC power supply.
SWHV	The same voltage as the HV line which is controlled by the HVSW circuit (Q28, Q30, Q31). When the [POWER] switch (LOGIC unit; S1) is pushed, the CPU (LOGIC unit; IC1, pin 40) outputs the "PWRON" control signal to the power switching circuit to turn the circuit ON.
C5V	Common 5 V for the CPU (LOGIC unit; IC1) converted from the HV line by the C5V regulator circuit (IC8). The circuit outputs the voltage regardless of the power ON/OFF condition.
+8V	Common 8 V converted from the SWHV line by the +8V regulator circuit (IC7).
+5V	Common 5 V converted from the +8V line by the +5V regulator circuit (Q21, Q22).
T8	Transmit 8 V controlled by the T8 regulator circuit (Q14, Q15) using the "TXC" signal from the I/O expander IC (IC2, pin 6). The voltage is converted from the +8V line at the regulator circuit.
R5V	Receive 5 V controlled by the R5 regulator circuit (Q25) using the "RXC" signal from the I/O expander IC (IC2, pin 5). The voltage is converted from the +5 V line at the regulator circuit.

4-5 PORT ALLOCATIONS

4-5-1 D/A CONVERTER IC (MAIN UNIT; IC5)

Pin number	Port name	Description
2	T3	Outputs RF tracking voltage while receiving.
3	SQLATT	Outputs attenuator control signal.
10	FC	Outputs reference frequency control voltage.
11	SQLIN	Outputs squelch control signal to adjust threshold level.
14	DTC	Outputs DTCS slope correction signal.
15	MOD	Outputs transmitting deviation control signal.
22	T2	Outputs RF tracking voltage while receiving.
23	T1	<ul style="list-style-type: none"> • Outputs RF tracking voltage while receiving. • Outputs transmitting power control signal while transmitting.

4-5-2 EXPANDER IC (MAIN UNIT; IC2)

Pin number	Port name	Description
4	AFMUTE	Outputs AF mute control signal. High: While muting.
5	RXC	Outputs R5 regulator (Q25) control signal. Low: While receiving.
6	TXC	Outputs T8 regulator (Q14 and Q15) control signal. High: While transmitting.
11	W/N	Outputs 2nd IF filter select signal ([W/N] version ONLY). High: While wide passband width (± 5.0 kHz) is selected (FI1 is selected). Low: While narrow passband width (± 2.5 kHz) is selected (FI2 is selected).
14	SHIFT	Outputs VCO regulator (Q1, Q3, Q5, Q8, D1) control signal. Low: While transmitting. High: While receiving.

4-5-3 CPU (LOGIC UNIT; IC1)

Pin number	Port name	Description
1	CTCIN	Input port for the CTCSS/DTCS signals.
2	SQLV	Input port for squelch volume detecting signal.
3	MICUD	Input port for the [▲] and [▼] switches from the external microphone.
4	SD	Input port for the S-meter voltage detecting signal.
5	LVIN	Input port for the PLL lock voltage.
6	TEMP	Input port for the transceiver's internal temperature detecting signal.
7	DETO	Input port for the weather channel alert detecting signal.
8	COLOR	Outputs LCD backlight color select signal. Low: Umber color is selected.
9 10	DIM0 DIM1	Output LCD backlight brightness controls signals
14	CSHIFT	Outputs the CPU clock shift control signal.
19	RESET	Input port for the reset signal.
25	PWRSW	Input port for [POWER] switch. Low: [POWER] switch is pushed.
26	NOIS	Input port for the noise pulse signal for squelch and CPU.
28 29	DICK DIUD	Input ports for encoder signals.
30	CLIN	Input port for the cloning signal.
31	CLOUT	Output port for the cloning signal.
34	SCK	Outputs serial clock signal to the D/A convertor (MAIN unit; IC5, pin 7).
35	BUSY	Outputs "BUSY" signal to the UT-115.
40	PWRON	Outputs [POWER] switch control signal. High: [POWER] is ON.
42	BSHIFT	Outputs band shift signal. Low : While receiving Air band (118–136 MHz).
43	PLLSTB	Outputs strobe signal to the PLL IC (MAIN unit; IC1, pin 4).
44	PLLCK	Outputs clock signal to the PLL IC (MAIN unit; IC1, pin 2).
45	EXSTB OPV3	• Outputs strobe signal to the expander IC (MAIN unit; IC2, pin 1). • Input port for the optional unit detecting signal.
46	UNLK	Input port for the PLL unlock signal.
47	REMO	Input port for the HM-133V remote microphone signals.
49 51	MICS AFON	Output transmitting/receiving AF filter select signal to the analog switch (IC6, pin 6 ["AFON" is applied to the pin 12]).

Pin number	Port name	Description
53–55	IS0–IS2	Output initial matrix strobe signals.
56, 57	KS1, KS2	Output key scan signals
58–61	KR3–KR0	Input ports for the keyboard matrix signals.
62	PTT	Input port for the [PTT] switch signal. High: While transmitting.
64	DI_SEC	Outputs digital/analog select signal while the UT-115 is installed. High : Digital is selected.
65	TX_DIGI	Outputs filter characteristic control signal while the UT-115 is installed. Low : While transmitting digital signal.
66	SO	• Outputs serial data to D/A convertor (MAIN unit; IC5, pin 8). • Outputs DTMF clock signal to the expander IC (MAIN unit; IC2, pin 2).
67	OPSCK	Outputs clock signal to the optional unit.
68	OPV1 DASTB	• Input port for the optional unit detecting signal. • Outputs strobe signal to the D/A converter (MAIN unit; IC5, pin 6).
69	OPV2	Input port for the optional unit detecting signal.
73	EXTMIC	Input port for detecting signal whether the multifunction microphone is connected or not. Low: The multifunction microphone is connected.
74	DUSE	Outputs low-pass filter cut-off frequency control signal when using DTCS.
75	ESCK	Outputs clock signal to the EEPROM (IC5, pin 6).
76	ESDA	I/O port for data signals from/to the EEPROM (IC5, pin 5).
77	OP_PS	Outputs the optional unit power supply control signal. High : Power is ON.
80	THROUGH	Outputs the ALC circuit control signal. High : The ALC circuit is OFF.
81	ALC	Outputs the ALC circuit control signal. High : The ALC circuit is ON.
84 85 86	OPT3 OPT2 OPT1	I/O ports for the optional unit control signals.
90, 92–127	SEG1– SEG36	Output LCD segment signals.
128–131	COM4– COM1	Output LCD common signals.
134–136	VL3– VL1	Output LCD device signals.
144	IDET	Input port for the current drain detecting signal while transmitting.

4-6 UT-115 CIRCUIT DESCRIPTION

4-6-1 RECEIVER CIRCUIT

The detected digital signals "FMDET" from the connected transceiver via the J301 (pin 22) are amplified at the buffer amplifier (IC251, pin 2). The amplified signals are applied to the GMSK modem circuit (IC252, pin 11), and are then applied to the CPU (IC204) as clock synchronizer digital signal. The digital signals from the CPU are applied to the AMBE voice CODEC IC (IC151) to process code extension, and are then applied to the linear CODEC IC (IC50) as 32 bits digital voice data. The applied digital signals are converted to the analog AF signals at the D/A converter section (IC50), and are then applied to the connected transceiver via the J301 (pin 21) as "DAFOUT" signal.

4-6-2 TRANSMITTER CIRCUIT

The analog AF signals "AMODIN" from the connected transceiver via the J301 (pin 4) are amplified at the buffer amplifier (IC251, pin 6). The amplified signals are applied to the linear CODEC IC (IC50, pin 5) to convert 32 bits digital voice data at the A/D converter section via the "ADIN" line. The digital signals are applied to the AMBE voice CODEC IC (IC151) to process code compression, and are then applied to the CPU (IC204). The digital signals from the CPU convert to the GMSK base band signal at the GMSK modem (IC252), and are then amplified at the buffer amplifier (IC253, pin 5). The amplified signals are applied to the connected transceiver via the J301 (pin 3).

4-6-3 RESET CIRCUIT

The UT-115 has the reset IC (IC203). The IC outputs reset signal to the CPU (IC204, pin 7) when "VDD" port (pin 2) becomes more than 2.8 V.

4-6-4 RS-232C CIRCUIT

IC351 is a RS-232C compatible serial interface IC which converts data between the CPU and the external equipment (EX: Personal Computer).

4-6-5 LEVEL CONVERTER CIRCUIT

The level converter circuit (Q305 and Q306) converts communication data level between the CPU (IC204) and the connected transceiver's CPU.

Q301, Q302 and Q303 convert control signals level between the UT-115 and the connected transceiver.

• UT-115 BLOCK DIAGRAM

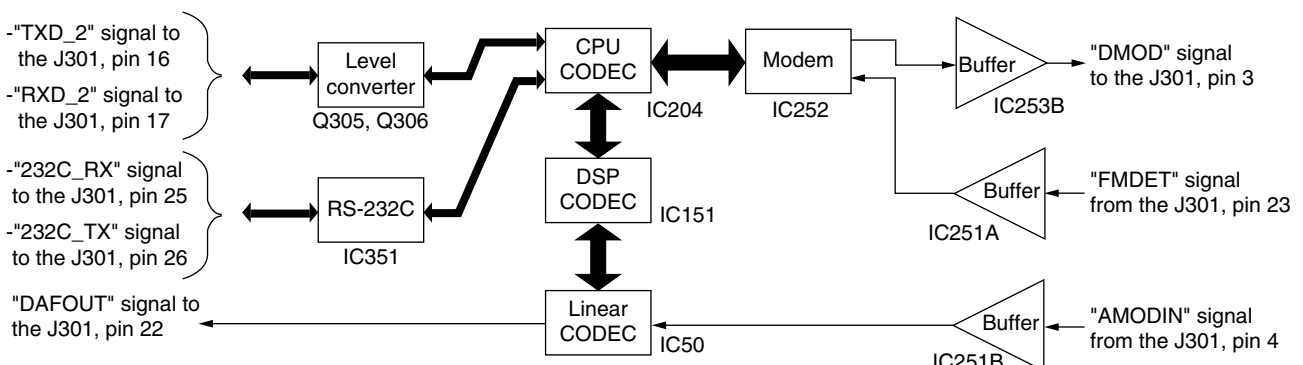

4-7 UT-115 POWER SUPPLY CIRCUITS VOLTAGE LINES

Line	Description
5V	The 5 V voltage from the connected transceiver via the J301 (pin 29). The 5V line is controlled by the +5V control circuit (Q50 and Q51). The circuit is controlled by the "PSAVE" signal from the CPU (IC204, pin 58 and 59).
3.3V	Common 3.3 V converted from the 5V line by the 3.3V regulator circuit (IC1). One of the 3.3 V line is controlled by the +3V control circuit (Q400 and Q401). The circuit is controlled by the "PSAVE" signal from the CPU (IC204, pin 58 and 59).
3.2V	Common 3.2 V converted from the 4.5–8 V line by the 3.2V regulator circuit (IC2). The circuit is controlled by the "APWR" signal from the CPU (IC204, pin 16).

4-8 UT-115 PORT ALLOCATIONS

4-8-1 MODEM IC (IC252)

Pin number	Port name	Description
2	MCLK	Outputs 2.4576 MHz clock signal to the CPU (IC151, pin 39).
7	ACQ	Outputs the PLL band width control signal while receiving.
19	TXDT	Outputs transmitting data signal to the CPU (IC204, pin 54).
20	RXDT	Input port for receiving data signal from the CPU (IC204, pin 53).
21	RXCK	Input port for receive clock signal from the CPU (IC204, pin 52).
22	TXCK	Outputs transmit clock signal to the CPU (IC204, pin 51).

4-8-2 CPU (IC2)

Pin number	Port name	Description
7	RES	Input port for the reset signal from the reset IC (IC203, pin 1). Low :The CPU is reset.
10	OSC2	Outputs 9.8304 MHz reference signal.
11	OSC1	Input port for 9.8304 MHz reference signal.
16	APWR	Outputs 3.2V regulator circuit (IC2, pin 3) control signal.
29	RMUTE_C	Outputs receive AF mute control signal to the connected transceiver via the J301 (pin 24). High :While muting.
31	PTTOUT_C	Outputs PTT signal to the connected transceiver via the J301 (pin 2). High :While transmitting.
33	ATXD	Outputs transmit data signal to the CPU (IC151, pin 32).
34	ACLK	Outputs clock signal to the CPU (IC151, pins 28 and 34).
36	ASTB	Outputs strobe signal to the CPU (IC151, pins 30 and 38).
37	ARXD	Input port for receive data signal from the CPU (IC151, pin 42).
38	ARES	Outputs reset signal to the linear CODEC IC (IC50, pin 13).
58 59	PSAVE	Output power save control signal to the +3V controller circuit (Q400 and Q401). Low :Power save is ON.
61	BUSY	Input port for the BUSY signal from the connected transceiver via the J301 (pin 6). High :While receiving signals.
62	PTTIN	Input port for the PTT signal from the connected transceiver via the J301 (pin 1). High :While transmitting.

SECTION 5 ADJUSTMENT PROCEDURES

5-1 PREPARATION

Enter the adjustment mode when adjusting the IC-2200H Then the JIG cable as shown the page 5-2 is required .

■ REQUIRED TEST EQUIPMENT

EQUIPMENT	GREDE AND RANGE	EQUIPMENT	GREDE AND RENGE
DC power supply	Output voltage : 13.8 V DC Current capacity : 20 A or more	FM deviation meter	Frequency range : 0–400 MHz Measuring range : 0 to ±5 kHz
RF power meter (terminated type)	Measuring range : 0.1–100 W Frequency range : 50–400 MHz Impedance : 50 Ω SWR : Less than 1.2 : 1	Oscilloscope	Frequency range : DC–400 MHz Measuring range : 0.01–10 V
Frequency counter	Frequency range : 0.1–400 MHz Frequency accuracy : ±1 ppm or better Sensitivity : 100 mV or better	Audio generator	Frequency range : 300–3000 Hz Measuring range : 1–500 mV
Standard signal generator (SSG)	Frequency range : 0.1–400 MHz Output level : 0.1 μV–32 mV (–127 to –17 dBm)	Attenuator	Power attenuation : 50 or 60 dB Capacity : 150 W or more

■ ENTERING THE ADJUSTMENT MODE

- ① Turn the transceiver's power OFF.
- ② Connect the JIG cable to the [MIC] jack.
- ③ Push and hold the [SET] and [MONI] keys, and then turn power ON.

NOTE: Exiting from the adjustment mode when the transceiver's power is OFF.

■ OPERATING ON THE ADJUSTMENT MODE

- Change the adjustment value : [DIAL]
- Verifying the adjustment value : [M/CALL] key
- Forward the adjustment item : [BANK] key
- Go back the adjustment item : [V/MHz] key
- Store the adjustment value in the memory : [S.MW] key

CAUTION: Need to push the [S.MW] key when storing the adjustment value in the memory. Otherwise, the transceiver is not adjusted properly.

IMPORTANT!: The transceiver need to be cancelled adjustment mode (as following method) to use normal mode when adjustments are finished, otherwise the transceiver does not work properly.

- ①: Turn the power OFF.
- ②: Push and hold [S.MW] and [SET] keys, and then turn the power ON.

■ CONNECTIONS

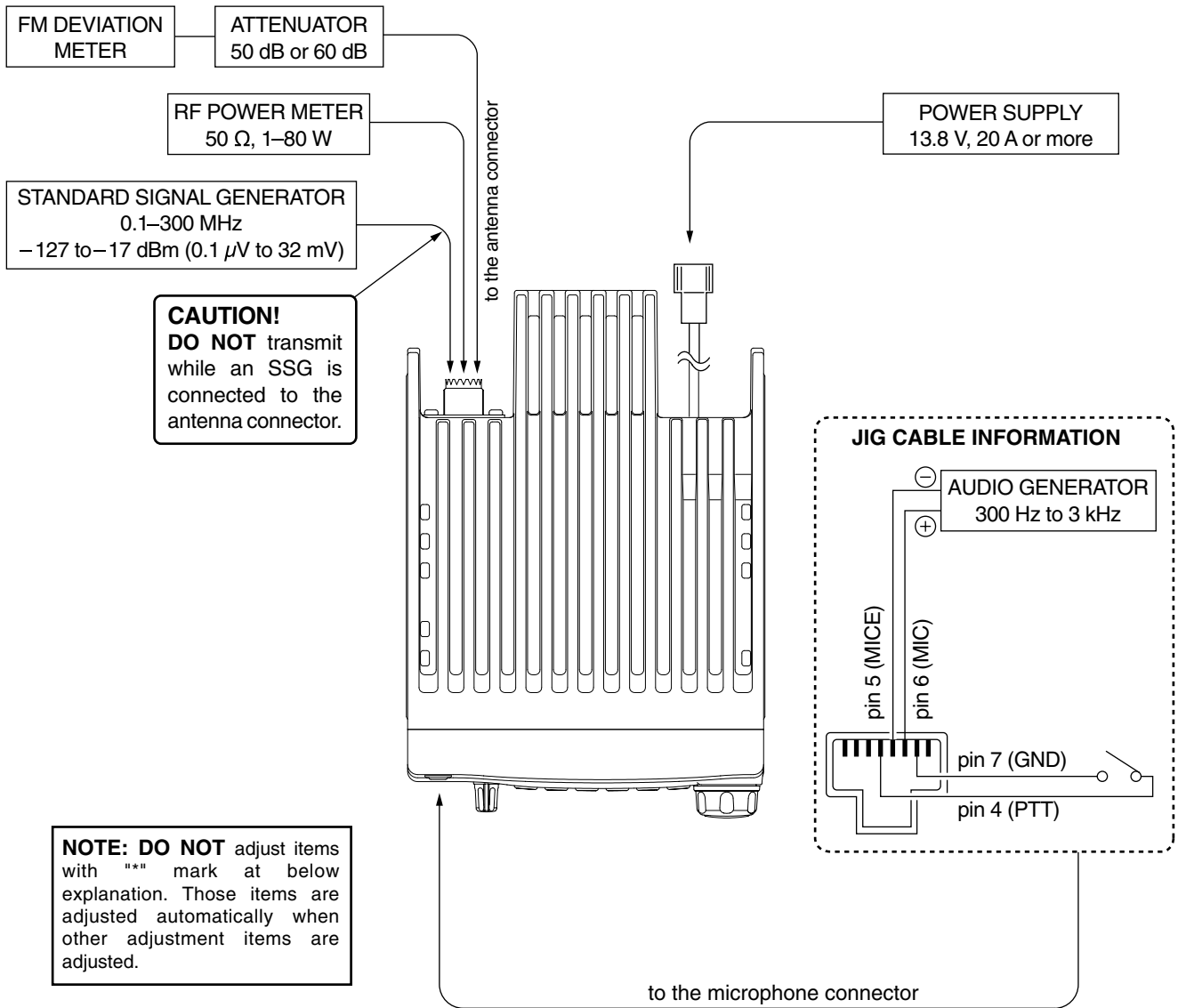

• ADJUSTMENT ITEM EXPLANATION

Starting item

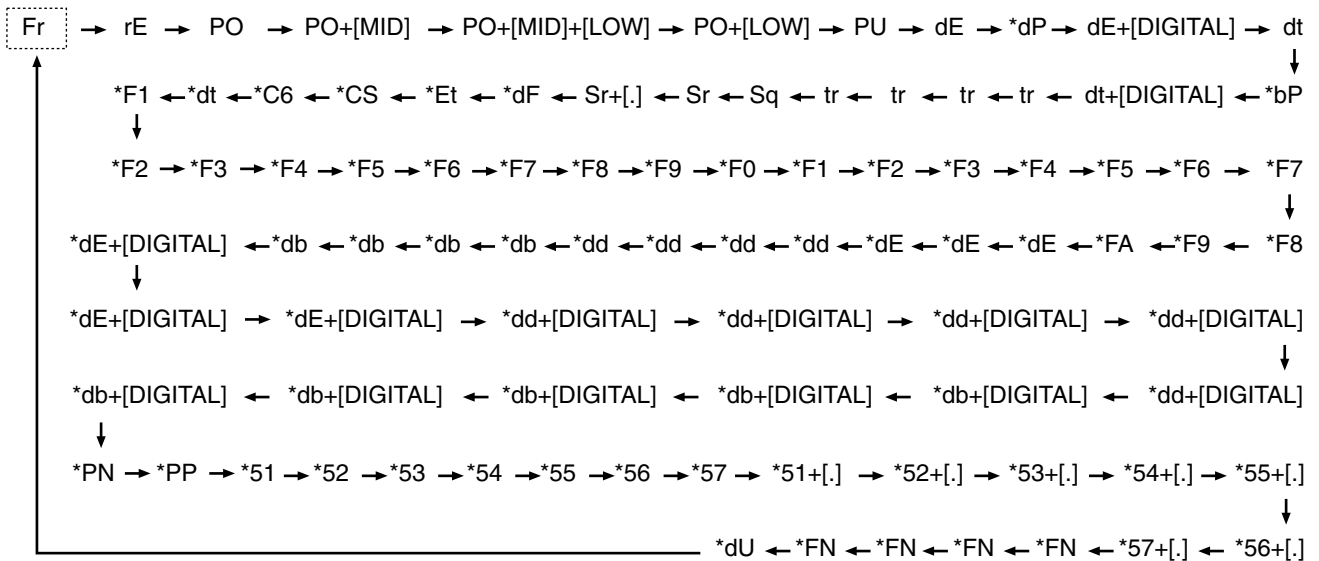

*Not adjust items

5-2 SOFTWARE ADJUSTMENTS (TRANSMITTING AND RECEIVING)

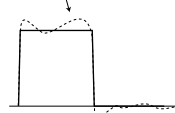
ADJUSTMENT	ADJUSTMENT CONDITION	OPERATION
REFERENCE FREQUENCY [Fr]	1 <ul style="list-style-type: none"> Operating frequency : 146.0 MHz Loosely couple a frequency counter to the antenna connector on the rear panel. Transmitting 	<ul style="list-style-type: none"> Turn the [DIAL] to set to 146.0000 MHz. Push the [S.MW] key.
REFERENCE VOLTAGE [rE]	1 <ul style="list-style-type: none"> Operating frequency : 146.0 MHz Receiving 	<ul style="list-style-type: none"> Push the [S.MW] key.
VHF OUTPUT POWER (High) [PO]	1 <ul style="list-style-type: none"> Operating frequency : 146.0 MHz Connect an RF power meter to the antenna connector. Transmitting 	<ul style="list-style-type: none"> Turn the [DIAL] to set the VHF high power to 67 W. Push the [S.MW] key.
(Middle) [PO+MID]	2 <ul style="list-style-type: none"> Operating frequency : 146.0 MHz Transmitting 	<ul style="list-style-type: none"> Turn the [DIAL] to set the VHF middle power to 25 W. Push the [S.MW] key.
(Middle-Low) [PO+MID+LOW]	3 <ul style="list-style-type: none"> Operating frequency : 146.0 MHz Transmitting 	<ul style="list-style-type: none"> Turn the [DIAL] to set the VHF low power to 10 W. Push the [S.MW] key.
(Low) [PO+LOW]	4 <ul style="list-style-type: none"> Operating frequency : 146.0 MHz Transmitting 	<ul style="list-style-type: none"> Turn the [DIAL] to set the VHF low power to 5 W. Push the [S.MW] key.
PROTECT VOLTAGE [PU]	1 <ul style="list-style-type: none"> Operating frequency : 146.0 MHz [High]/[Low] switch : High Connect an RF power meter to the antenna connector. Transmitting 	<ul style="list-style-type: none"> Push the [S.MW] key while transmitting.
FREQUENCY DEVIATION (Analog) [dE]	1 <ul style="list-style-type: none"> Operating frequency : 146.0 MHz IF bandwidth : Wide Connect an audio generator to the [MIC] jack and set as : 1 kHz/80 mV rms Connect an FM deviation meter to the antenna connector and set as : <ul style="list-style-type: none"> HPF : OFF LPF : 20 kHz De-emphasis : OFF Detector : (P-P)/2 Transmitting 	<ul style="list-style-type: none"> Turn the [DIAL] to set to ± 4.6 kHz. Push the [S.MW] key after finish adjustment.
DIGITAL VCO DEVIATION [dE+DIGITAL]	1 <ul style="list-style-type: none"> Operating frequency : 146.0 MHz IF bandwidth : Wide No audio signal is applied to the [MIC] jack. Connect an FM deviation meter to the antenna connector and set as : <ul style="list-style-type: none"> HPF : OFF LPF : 20 kHz De-emphasis : OFF Detector : (P-P)/2 Transmitting 	<ul style="list-style-type: none"> Turn the [DIAL] to set to ± 1.25 kHz. Push the [S.MW] key after finish adjustment.
DTCS WAVE FORM [dt]	1 <ul style="list-style-type: none"> Operating frequency : 146.0 MHz IF bandwidth : Wide No audio signal is applied to the [MIC] jack. DTCS code : 023 Set an FM deviation meter as: <ul style="list-style-type: none"> HPF : OFF LPF : 20 kHz De-emphasis : OFF Detector : (P-P)/2 Transmitting 	<ul style="list-style-type: none"> Turn the [DIAL] to set to flat wave form as shown below. Push the [S.MW] key after finish adjustment. <div style="text-align: center;"> <p>Set to flat wave form</p>  </div>

SOFTWARE ADJUSTMENTS (TRANSMITTING AND RECEIVING)–Continued

ADJUSTMENT		ADJUSTMENT CONDITION	OPERATION
DIGITAL REFERENCE DEVIATION [dt+DIGITAL]	1	<ul style="list-style-type: none"> • Operating frequency : 146.0 MHz • IF bandwidth : Wide • No audio signal is applied to the [MIC] jack. • Connect an FM deviation meter to the antenna connector and set as : <ul style="list-style-type: none"> HPF : OFF LPF : 20 kHz De-emphasis : OFF Detector : (P–P)/2 • Transmitting 	<ul style="list-style-type: none"> • Turn the [DIAL] to set to ± 0.85 kHz. • Push the [S.MW] key after finish adjustment.
RECEIVER SENSITIVITY [tr]	1	<ul style="list-style-type: none"> • Operating frequency : 118.020 MHz • Connect an SSG to the antenna connector and set as <ul style="list-style-type: none"> Level : $0.5 \mu\text{V}^*$ (–113 dBm) Modulation : 1 kHz Deviation : ± 3.5 kHz • Receiving 	<ul style="list-style-type: none"> • Push the [S.MW] key.
	2	<ul style="list-style-type: none"> • Operating frequency : 136.020 MHz • Receiving 	<ul style="list-style-type: none"> • Push the [S.MW] key.
	3	<ul style="list-style-type: none"> • Operating frequency : 147.980 MHz • Receiving 	<ul style="list-style-type: none"> • Push the [S.MW] key.
	4	<ul style="list-style-type: none"> • Operating frequency : 173.980 MHz • Receiving 	<ul style="list-style-type: none"> • Push the [S.MW] key.
SQUELCH LEVEL (Wide) [Sq]	1	<ul style="list-style-type: none"> • Operating frequency : 145.020 MHz • Connect an SSG to the antenna connector and set as <ul style="list-style-type: none"> Level : $0.1 \mu\text{V}^*$ (–127 dBm) Modulation : 1 kHz Deviation : ± 3.5 kHz • Receiving 	<ul style="list-style-type: none"> • Turn the [DIAL] to set to squelch tight point. • Turn the [DIAL] to set to squelch threshold point. • Push the [S.MW] key.
S-METER (FM mode) [Sr]	1	<ul style="list-style-type: none"> • Operating frequency : 145.020 MHz • Connect an SSG to the antenna connector and set as <ul style="list-style-type: none"> Level : $1.3 \mu\text{V}^*$ (–105 dBm) Modulation : 1 kHz Deviation : ± 3.5 kHz • Receiving 	<ul style="list-style-type: none"> • Push the [S.MW] key.
(AM mode) [Sr+.]	2	<ul style="list-style-type: none"> • Operating frequency : 127.020 MHz • Connect an SSG to the antenna connector and set as <ul style="list-style-type: none"> Level : $1.0 \mu\text{V}^*$ (–107 dBm) Modulation : 1 kHz Deviation : 30 % • Receiving 	<ul style="list-style-type: none"> • Push the [S.MW] key.

*This output level of a standard signal generator (SSG) is indicated as SSG's open circuit.

5-3 UT-115 ADJUSTMENT PROCEDURES

• PREPARATION

Enter the adjustment mode when adjusting the UT-115.

■ REQUIRED TEST EQUIPMENT

EQUIPMENT	GRADE AND RANGE	EQUIPMENT	GRADE AND RANGE
DC power supply 1	Output voltage : 5.0 V DC Current capacity : 1 A or more	Frequency counter	Frequency range : 0.1–100 MHz Frequency accuracy : ±1 ppm or better Sensitivity : 100 mV or better
DC power supply 2	Output voltage : 8.0 V DC Current capacity : 1 A or more	Oscilloscope	Frequency range : DC–400 MHz Measuring range : 0.01–10 V

■ ENTERING THE ADJUSTMENT MODE

Connect J301, pin 14 to GND, then the UT-115 enters adjustment mode.

NOTE: Exit from the adjustment mode to disconnect J301, pin 14 from GND before the UT-115 adjustment is finished

■ CONNECTION

• UT-115 BOTTOM VIEW

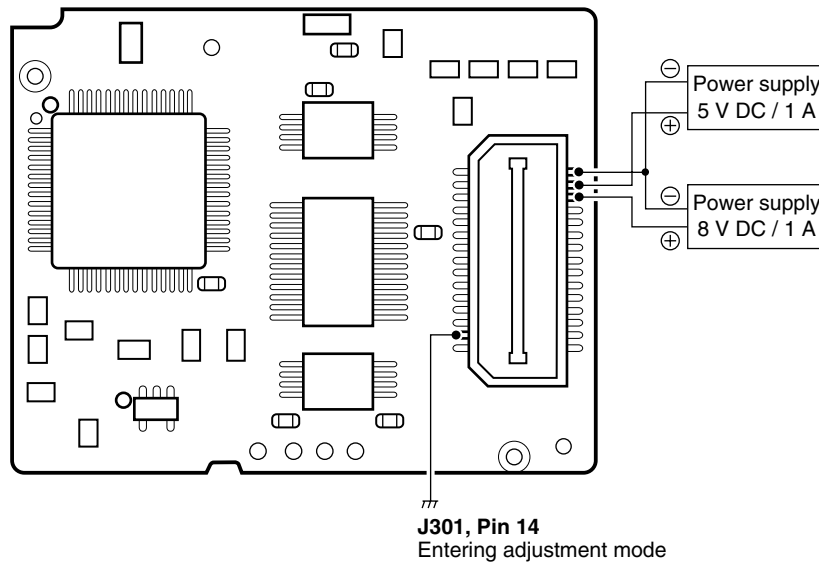

5-4 TRIMMER ADJUSTMENTS

ADJUSTMENT	MEASUREMENT UNIT	MEASUREMENT LOCATION	VALUE	ADJUSTMENT POINT		
				UNIT	ADJUST	
CODEC FREQUENCY SET	1	MAIN	Connect the frequency counter to the check point CP101.	16.38400 MHz \pm 10 Hz	MAIN	C102
MODEM FREQUENCY SET	1	MAIN	Connect the frequency counter to the check point CP216.	2.457600 MHz \pm 3 Hz	MAIN	C207
MODURATION OUTPUT LEVEL	1	MAIN	• Transmit the UT-115 to connect J301, pin 1 to GND.	350 mV _{p-p} \pm 10 mV	MAIN	R264
	2		• Connect the oscilloscope to the J301, pin 21.			
	3		Disconnect J301, pin 1 from GND.			

• UT-115 TOP VIEW

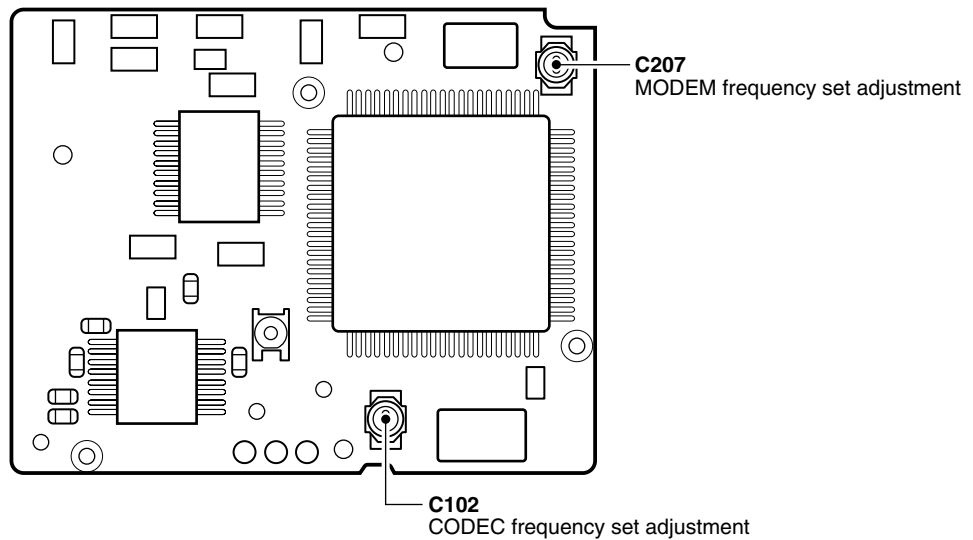

• UT-115 BOTTOM VIEW

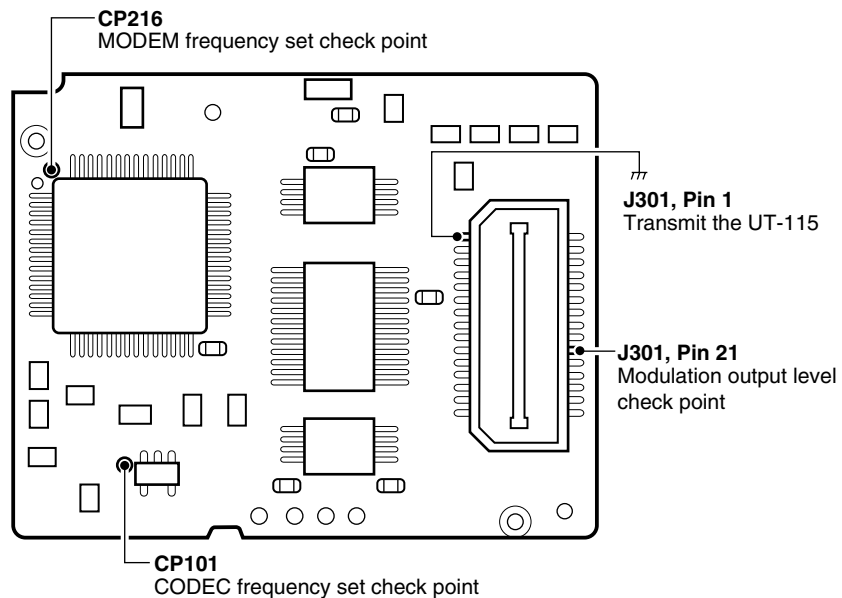

SECTION 6 PARTS LIST

6-1 IC-2200H

[LOGIC UNIT]

REF NO.	ORDER NO.	DESCRIPTION	M.
IC1	1140011860	S.IC M30220FCRP (FX-2698A) [EXP]	B
	1140011861	S.IC M30220FCRP (FX-2698A-1) [USA]	B
	1140011910	S.IC M30220MA-132RP (FX-2698A-1) except [EXP] and [USA]	B
IC2	1130004200	S.IC TC4S66F (TE85R)	B
IC3	1110005340	S.IC NJM12902V-TE1	B
IC4	1110006210	S.IC BD5242FVE-TR	B
IC5	1140008650	S.IC HN58X2464TI	B
IC6	1130011770	S.IC CD4066BPWR	T
IC24	1110002860	S.IC TA75S393F (TE85R)	T
IC514	1110005310	S.IC AN6123MS	B
IC520	1130011770	S.IC CD4066BPWR	T
IC521	1130008560	S.IC TC75S51F (TE85L)	B
IC522	1130011770	S.IC CD4066BPWR	B
IC524	1130011780	S.IC SN74AHC2G53HDCTR	B
IC525	1130011770	S.IC CD4066BPWR	T
Q1	1530002690	S.TRANSISTOR 2SC4116-GR (TE85R)	T
Q2	1590000430	S.TRANSISTOR DTC144EUA T106	B
Q3	1590001650	S.TRANSISTOR XP4601 (TX)	B
Q5	1590000660	S.TRANSISTOR DTC144TU T106	B
Q6	1510000510	S.TRANSISTOR 2SA1576A T106R	B
Q7	1530002690	S.TRANSISTOR 2SC4116-GR (TE85R)	B
Q8	1530002690	S.TRANSISTOR 2SC4116-GR (TE85R)	B
Q12	1530002690	S.TRANSISTOR 2SC4116-GR (TE85R)	B
Q513	1520000200	S.TRANSISTOR 2SB798-T2 DK	B
Q514	1530002690	S.TRANSISTOR 2SC4116-GR (TE85R)	B
Q515	1510000510	S.TRANSISTOR 2SA1576A T106R	B
Q524	1510000510	S.TRANSISTOR 2SA1576A T106R	T
Q525	1590000430	S.TRANSISTOR DTC144EUA T106	B
Q527	1590002230	S.TRANSISTOR UMG2N TL	B
Q528	1590002430	S.TRANSISTOR DTA144EE TL	T
D1	1730002280	S.ZENER MA8091-M (TX)	T
D2	1790001250	S.DIODE MA2S111-(TX)	T
D3	1730002280	S.ZENER MA8091-M (TX)	B
D4	1750000520	S.DIODE DAN222TL	B
D6	1750000370	S.DIODE DA221 TL	B
D7	1750000520	S.DIODE DAN222TL	T
D8	1750000520	S.DIODE DAN222TL	T
D9	1750000520	S.DIODE DAN222TL	T
D11	1710000611	DIODE 1SS133 T77 (26M/M) [TPE], [KOR], [EUR-1] only	B
D13	1750000940	S.DIODE ISS400 TE61 except [EXP], [EXP-1]	B
D15	1750000940	S.DIODE ISS400 TE61 [EXP], [EXP-1] only	B
D16	1750000940	S.DIODE ISS400 TE61 [EUR], [EUR-1], [EXP], [EXP-1] only	B
D17	1750000940	S.DIODE ISS400 TE61 [TPE], [KOR], [EXP], [EXP-1] only	B
D21	1750000520	S.DIODE DAN222TL	T
D22	1750000940	S.DIODE ISS400 TE61 [TPE], [EXP], [EXP-1] only	B
D23	1750000940	S.DIODE ISS400 TE61 [TPE], [KOR] only	B
D25	1790001260	S.DIODE MA2S077-(TX)	B
D27	1750000940	S.DIODE ISS400 TE61 except [EXP-1]	B
D28	1750000940	S.DIODE ISS400 TE61 [EXP], [EXP-1] only	B
D526	1790001250	S.DIODE MA2S111-(TX)	B
X1	6050011500	S.XTAL CR-739 (9.8304 MHz)	B
R1	7030008010	S.RESISTOR ERJ2GEJ 123 X (12 kΩ)	T
R2	7030005310	S.RESISTOR ERJ2GEJ 124 X (120 kΩ)	T
R3	7030005050	S.RESISTOR ERJ2GEJ 103 X (10 kΩ)	B
R4	7030005050	S.RESISTOR ERJ2GEJ 103 X (10 kΩ)	B
R5	7030005230	S.RESISTOR ERJ2GEJ 334 X (330 kΩ)	T
R6	7030005090	S.RESISTOR ERJ2GEJ 104 X (100 kΩ)	B
R7	7030004980	S.RESISTOR ERJ2GEJ 101 X (100 Ω)	B
R8	7030007290	S.RESISTOR ERJ2GEJ 222 X (2.2 kΩ)	T
R9	7030005220	S.RESISTOR ERJ2GEJ 223 X (22 kΩ)	B
R10	7030005050	S.RESISTOR ERJ2GEJ 103 X (10 kΩ)	T
R11	7030005090	S.RESISTOR ERJ2GEJ 104 X (100 kΩ)	B
R12	7030005090	S.RESISTOR ERJ2GEJ 104 X (100 kΩ)	T
R13	7030008010	S.RESISTOR ERJ2GEJ 123 X (12 kΩ)	B
R14	7030005050	S.RESISTOR ERJ2GEJ 103 X (10 kΩ)	B
R15	7030005120	S.RESISTOR ERJ2GEJ 102 X (1 kΩ)	B

M.=Mounted side (T: Mounted on the Top side, B: Mounted on the Bottom side)

[LOGIC UNIT]

REF NO.	ORDER NO.	DESCRIPTION	M.
R16	7030005070	S.RESISTOR ERJ2GEJ 683 X (68 kΩ)	B
R17	7030005070	S.RESISTOR ERJ2GEJ 683 X (68 kΩ)	B
R18	7030005720	S.RESISTOR ERJ2GEJ 563 X (56 kΩ)	B
R19	7030005120	S.RESISTOR ERJ2GEJ 102 X (1 kΩ)	B
R20	7030005120	S.RESISTOR ERJ2GEJ 102 X (1 kΩ)	B
R21	7030005070	S.RESISTOR ERJ2GEJ 683 X (68 kΩ)	B
R22	7030005120	S.RESISTOR ERJ2GEJ 102 X (1 kΩ)	B
R23	7030005090	S.RESISTOR ERJ2GEJ 104 X (100 kΩ)	B
R24	7030007340	S.RESISTOR ERJ2GEJ 153 X (15 kΩ)	B
R25	7030005050	S.RESISTOR ERJ2GEJ 103 X (10 kΩ)	B
R26	7030005220	S.RESISTOR ERJ2GEJ 223 X (22 kΩ)	B
R27	7030003630	S.RESISTOR ERJ3GGEYJ 393 V (39 kΩ)	B
		[EXP] only	B
	7030007350	S.RESISTOR ERJ2GEJ 393 X (39 kΩ)	[other]
R28	7030005090	S.RESISTOR ERJ2GEJ 104 X (100 kΩ)	B
R29	7030005050	S.RESISTOR ERJ2GEJ 103 X (10 kΩ)	B
R30	7030007340	S.RESISTOR ERJ2GEJ 153 X (15 kΩ)	B
R31	7030005720	S.RESISTOR ERJ2GEJ 563 X (56 kΩ)	B
R32	7030007570	S.RESISTOR ERJ2GEJ 122X (1.2 kΩ)	B
R34	7030005070	S.RESISTOR ERJ2GEJ 683 X (68 kΩ)	B
R35	7030005090	S.RESISTOR ERJ2GEJ 104 X (100 kΩ)	B
R36	7030008010	S.RESISTOR ERJ2GEJ 123 X (12 kΩ)	B
R37	7030005090	S.RESISTOR ERJ2GEJ 104 X (100 kΩ)	B
R38	7030008400	S.RESISTOR ERJ2GEJ 182 X (1.8 kΩ)	B
R39	7030005100	S.RESISTOR ERJ2GEJ 154 X (150 kΩ)	B
R40	7030005240	S.RESISTOR ERJ2GEJ 473 X (47 kΩ)	T
R41	7030008010	S.RESISTOR ERJ2GEJ 123 X (12 kΩ)	B
R42	7030005160	S.RESISTOR ERJ2GEJ 105 X (1 MΩ)	B
R43	7030005160	S.RESISTOR ERJ2GEJ 105 X (1 MΩ)	B
R44	7030005160	S.RESISTOR ERJ2GEJ 105 X (1 MΩ)	B
R45	7030008410	S.RESISTOR ERJ2GEJ 392 X (3.9 kΩ)	B
R46	7410000770	S.ARRAY EXB-V4V 102JV (1 kΩ)	T
R47	7030005090	S.RESISTOR ERJ2GEJ 104 X (100 kΩ)	T
R48	7030005160	S.RESISTOR ERJ2GEJ 105 X (1 MΩ)	B
R49	7030005600	S.RESISTOR ERJ2GEJ 273 X (27 kΩ)	B
R50	7030005160	S.RESISTOR ERJ2GEJ 105 X (1 MΩ)	B
R51	7030005530	S.RESISTOR ERJ2GEJ 100 X (10 Ω)	B
R52	7030005120	S.RESISTOR ERJ2GEJ 102 X (1 kΩ)	T
R53	7030007310	S.RESISTOR ERJ2GEJ 155 X (1.5 MΩ)	B
R55	7030005120	S.RESISTOR ERJ2GEJ 102 X (1 kΩ)	B
		[EUR], [EXP], [EXP-1] only	B
R56	7030004050	S.RESISTOR ERJ3GGEYJ 1R0 V (1 Ω)	B
R57	7030007340	S.RESISTOR ERJ2GEJ 153 X (15 kΩ)	B
R58	7030005090	S.RESISTOR ERJ2GEJ 104 X (100 kΩ)	B
R59	7030007340	S.RESISTOR ERJ2GEJ 153 X (15 kΩ)	B
R60	7030005720	S.RESISTOR ERJ2GEJ 563 X (56 kΩ)	B
R61	7210001870	VARIABLE EVU-F2AF20 A14 (10KA)	T
R62	7210001860	VARIABLE EVU-F2AF20 B14 (10KB)	T
R64	7030005160	S.RESISTOR ERJ2GEJ 105 X (1 MΩ)	B
R67	7030008290	S.RESISTOR ERJ2GEJ 183 X (18 kΩ)	B
R69	7030005100	S.RESISTOR ERJ2GEJ 154 X (150 kΩ)	B
R70	7030007350	S.RESISTOR ERJ2GEJ 393 X (39 kΩ)	B
R71	7030005050	S.RESISTOR ERJ2GEJ 103 X (10 kΩ)	B
R72	7030005110	S.RESISTOR ERJ2GEJ 224 X (220 kΩ)	B
R73	7030008300	S.RESISTOR ERJ2GEJ 184 X (180 kΩ)	B
R74	7030005100	S.RESISTOR ERJ2GEJ 154 X (150 kΩ)	B
R75	7030005070	S.RESISTOR ERJ2GEJ 683 X (68 kΩ)	B
R76	7030008290	S.RESISTOR ERJ2GEJ 183 X (18 kΩ)	B
R77	7030009290	S.RESISTOR ERJ2GEJ 562 X (5.6 kΩ)	B
R78	7030005090	S.RESISTOR ERJ2GEJ 104 X (100 kΩ)	B
R79	7030005040	S.RESISTOR ERJ2GEJ 472 X (4.7 kΩ)	B
R80	7030005120	S.RESISTOR ERJ2GEJ 102 X (1 kΩ)	B
R81	7030005310	S.RESISTOR ERJ2GEJ 124 X (120 kΩ)	B
R82	7030005120	S.RESISTOR ERJ2GEJ 102 X (1 kΩ)	B
R83	7030005590	S.RESISTOR ERJ2GEJ 680 X (68 Ω)	B
R84	7030005030	S.RESISTOR ERJ2GEJ 152 X (1.5 kΩ)	B
R85	7030005210	S.RESISTOR ERJ2GEJ 822 X (8.2 kΩ)	B
R86	7030009160	S.RESISTOR ERJ2GEJ 181 X (180 Ω)	B
R87	7410000950	S.ARRAY EXB-V8V 102JV	T
R89	7030009280	S.RESISTOR ERJ2GEJ	B
R91	7030005310	S.RESISTOR ERJ2GEJ 124 X (120 kΩ)	B
R92	7030008290	S.RESISTOR ERJ2GEJ 183 X (18 kΩ)	B
R93	7030005120	S.RESISTOR ERJ2GEJ 102 X (1 kΩ)	B
R94	7030005570	S.RESISTOR ERJ2GEJ 820 X (82 Ω)	B
R96	7030007350	S.RESISTOR ERJ2GEJ 393 X (39 kΩ)	B
R97	7030007270	S.RESISTOR ERJ2GEJ 151 X (150 Ω)	B
R100	7030007280	S.RESISTOR ERJ2GEJ 331 X (330 Ω)	B
R101	7030005040	S.RESISTOR ERJ2GEJ 472 X (4.7 kΩ)	B
R103	7030005100	S.RESISTOR ERJ2GEJ 154 X (150 kΩ)	B

S.=Surface mount

[LOGIC UNIT]

REF NO.	ORDER NO.	DESCRIPTION	M.
R104	7030005080	S.RESISTOR ERJ2GEJ 823 X (82 kΩ)	B
		[USA] only	B
	7030008290	S.RESISTOR ERJ2GEJ 183 X (18 kΩ)	B
		[other]	B
R105	7030005090	S.RESISTOR ERJ2GEJ 104 X (100 kΩ)	B
R106	7030005050	S.RESISTOR ERJ2GEJ 103 X (10 kΩ)	B
R107	7030005090	S.RESISTOR ERJ2GEJ 104 X (100 kΩ)	B
R108	7030005050	S.RESISTOR ERJ2GEJ 103 X (10 kΩ)	B
R109	7030005600	S.RESISTOR ERJ2GEJ 273 X (27 kΩ)	B
		[USA] only	B
R112	7030008010	S.RESISTOR ERJ2GEJ 123 X (12 kΩ)	B
R114	7030008010	S.RESISTOR ERJ2GEJ 123 X (12 kΩ)	B
R128	7030005050	S.RESISTOR ERJ2GEJ 103 X (10 kΩ)	B
R129	7030005090	S.RESISTOR ERJ2GEJ 104 X (100 kΩ)	B
R133	7030005240	S.RESISTOR ERJ2GEJ 473 X (47 kΩ)	B
R134	7030005050	S.RESISTOR ERJ2GEJ 103 X (10 kΩ)	B
R135	7030005050	S.RESISTOR ERJ2GEJ 103 X (10 kΩ)	B
R136	7030005090	S.RESISTOR ERJ2GEJ 104 X (100 kΩ)	B
R137	7030005240	S.RESISTOR ERJ2GEJ 473 X (47 kΩ)	B
R515	7030004980	S.RESISTOR ERJ2GEJ 101 X (100 Ω)	B
R516	7030010040	S.RESISTOR ERJ2GE-JPW	T
R517	7030005160	S.RESISTOR ERJ2GEJ 105 X (1 MΩ)	B
R519	7030005010	S.RESISTOR ERJ2GEJ 681 X (680 Ω)	B
R520	7030005240	S.RESISTOR ERJ2GEJ 473 X (47 kΩ)	B
R521	7030005240	S.RESISTOR ERJ2GEJ 473 X (47 kΩ)	B
R522	7030005100	S.RESISTOR ERJ2GEJ 154 X (150 kΩ)	B
R523	7030005160	S.RESISTOR ERJ2GEJ 105 X (1 MΩ)	B
R524	7030005050	S.RESISTOR ERJ2GEJ 103 X (10 kΩ)	B
R525	7030004980	S.RESISTOR ERJ2GEJ 101 X (100 Ω)	B
R526	7030005120	S.RESISTOR ERJ2GEJ 102 X (1 kΩ)	B
R527	7030005050	S.RESISTOR ERJ2GEJ 103 X (10 kΩ)	B
R530	7030005240	S.RESISTOR ERJ2GEJ 473 X (47 kΩ)	B
R531	7030005240	S.RESISTOR ERJ2GEJ 473 X (47 kΩ)	T
R532	7030005240	S.RESISTOR ERJ2GEJ 473 X (47 kΩ)	T
R533	7030005240	S.RESISTOR ERJ2GEJ 473 X (47 kΩ)	B
R534	7030005240	S.RESISTOR ERJ2GEJ 473 X (47 kΩ)	B
R536	7030005050	S.RESISTOR ERJ2GEJ 103 X (10 kΩ)	T
R537	7030005010	S.RESISTOR ERJ2GEJ 681 X (680 Ω)	T
R538	7030005240	S.RESISTOR ERJ2GEJ 473 X (47 kΩ)	B
R539	7030005240	S.RESISTOR ERJ2GEJ 473 X (47 kΩ)	B
R541	7030005240	S.RESISTOR ERJ2GEJ 473 X (47 kΩ)	B
R542	7030005240	S.RESISTOR ERJ2GEJ 473 X (47 kΩ)	B
R543	7030005240	S.RESISTOR ERJ2GEJ 473 X (47 kΩ)	B
R545	7410000770	S.ARRAY EXB-V4V 102JV (1 kΩ)	T
R546	7030005090	S.RESISTOR ERJ2GEJ 104 X (100 kΩ)	T
R548	7030000240	S.RESISTOR MCR10EZHZJ 68 Ω (680)	T
R549	7030000240	S.RESISTOR MCR10EZHZJ 68 Ω (680)	B
R550	7030010040	S.RESISTOR ERJ2GE-JPW	B
R551	7030005050	S.RESISTOR ERJ2GEJ 103 X (10 kΩ)	B
C1	4030017460	S.CERAMIC ECJ0EB1E102K	B
C4	4030017460	S.CERAMIC ECJ0EB1E102K	T
C5	4030017420	S.CERAMIC ECJ0EC1H470J	B
C7	4030017460	S.CERAMIC ECJ0EB1E102K	B
C8	4030016790	S.CERAMIC ECJ0EB1C103K	T
C9	4030017460	S.CERAMIC ECJ0EB1E102K	B
C10	4030017460	S.CERAMIC ECJ0EB1E102K	B
C11	4030017460	S.CERAMIC ECJ0EB1E102K	B
C13	4030017460	S.CERAMIC ECJ0EB1E102K	B
C14	4030017460	S.CERAMIC ECJ0EB1E102K	B
C15	4030017460	S.CERAMIC ECJ0EB1E102K	B
C16	4030017460	S.CERAMIC ECJ0EB1E102K	B
C19	4030016790	S.CERAMIC ECJ0EB1C103K	B
C20	4030017460	S.CERAMIC ECJ0EB1E102K	B
C23	4030017460	S.CERAMIC ECJ0EB1E102K	T
C28	4030017460	S.CERAMIC ECJ0EB1E102K	B
C30	4030017420	S.CERAMIC ECJ0EC1H470J	B
C31	4030017420	S.CERAMIC ECJ0EC1H470J	T
C32	4510004630	S.ELECTROLYTIC ECEV1CA100SR	B
C33	4030013960	S.CERAMIC C1005 JB 1C 473K-T-N	B
C34	4030017790	S.CERAMIC ECJ0EB1E682K	B
C35	4030017040	S.CERAMIC ECJ0EB1A333K	B
C36	4030016930	S.CERAMIC ECJ0EB1A104K	B
C37	4030016790	S.CERAMIC ECJ0EB1C103K	B
C38	4030018080	S.CERAMIC ECJ0EB1H182K	B
C39	4030017460	S.CERAMIC ECJ0EB1E102K	B
C40	4030017460	S.CERAMIC ECJ0EB1E102K	B
C41	4030016930	S.CERAMIC ECJ0EB1A104K	B
C42	4030016950	S.CERAMIC ECJ0EB1A473K	B
C43	4030016950	S.CERAMIC ECJ0EB1A473K	B
C44	4030018240	S.CERAMIC ECJ0EB1E562K	B
C45	4030016790	S.CERAMIC ECJ0EB1C103K	B
C46	4030016970	S.CERAMIC ECJ0EB1C223K	B
C47	4030016930	S.CERAMIC ECJ0EB1A104K	B
C48	4030017760	S.CERAMIC ECJ0EB1H222K	B
C49	4030016930	S.CERAMIC ECJ0EB1A104K	B
C51	4030017030	S.CERAMIC ECJ0EB1A273K	B
C52	4030017420	S.CERAMIC ECJ0EC1H470J	T

M.=Mounted side (T: Mounted on the Top side, B: Mounted on the Bottom side)

[LOGIC UNIT]

REF NO.	ORDER NO.	DESCRIPTION	M.
C53	4030017500	S.CERAMIC ECJ0EC1H560J	B
C54	4030016790	S.CERAMIC ECJ0EB1C103K	B
C55	4030017600	S.CERAMIC ECJ0EC1H080C	B
C56	4030017760	S.CERAMIC ECJ0EB1H222K	B
C57	4030018110	S.CERAMIC ECJ0EB1H272K	B
C59	4030017640	S.CERAMIC ECJ0EC1H150J	B
C62	4030017460	S.CERAMIC ECJ0EB1E102K	B
C64	4030016790	S.CERAMIC ECJ0EB1C103K	B
C65	4030016790	S.CERAMIC ECJ0EB1C103K	B
C66	4030016790	S.CERAMIC ECJ0EB1C103K	T
C67	4510004630	S.ELECTROLYTIC ECEV1CA100SR	B
C68	4030016930	S.CERAMIC ECJ0EB1A104K	B
C69	4030016930	S.CERAMIC ECJ0EB1A104K	B
C70	4030016790	S.CERAMIC ECJ0EB1C103K	T
C71	4030016790	S.CERAMIC ECJ0EB1C103K	B
C72	4030017040	S.CERAMIC ECJ0EB1A333K	B
C73	4510005860	S.ELECTROLYTIC ECEV1HA2R2SR	B
C74	4030018240	S.CERAMIC ECJ0EB1E562K	B
C75	4030017450	S.CERAMIC ECJ0EB1E271K	B
C76	4030017040	S.CERAMIC ECJ0EB1A333K	B
C77	4510005860	S.ELECTROLYTIC ECEV1HA2R2SR	B
C78	4030016790	S.CERAMIC ECJ0EB1C103K	B
C79	4030017440	S.CERAMIC ECJ0EC1H221J	B
C80	4030016790	S.CERAMIC ECJ0EB1C103K	B
C81	4030016790	S.CERAMIC ECJ0EB1C103K	B
C82	4030017730	S.CERAMIC ECJ0EB1E471K	B
C583	4030016930	S.CERAMIC ECJ0EB1A104K	T
C584	4030016930	S.CERAMIC ECJ0EB1A104K	T
C585	4030016930	S.CERAMIC ECJ0EB1A104K	B
C586	4510005600	S.ELECTROLYTIC ECEV1CS100SR	B
C587	4550006250	S.TANTALUM TEESVA 1A 106M8L	B
C588	4030017490	S.CERAMIC C1608 JB 1A 105K-T	B
C591	4030017460	S.CERAMIC ECJ0EB1E102K	T
C592	4030017460	S.CERAMIC ECJ0EB1E102K	B
C593	4030016930	S.CERAMIC ECJ0EB1A104K	B
C594	4030017460	S.CERAMIC ECJ0EB1E102K	B
C595	4030017460	S.CERAMIC ECJ0EB1E102K	T
C596	4030017460	S.CERAMIC ECJ0EB1E102K	B
C597	4030017460	S.CERAMIC ECJ0EB1E102K	B
C599	4030016930	S.CERAMIC ECJ0EB1A104K	B
C600	4030017460	S.CERAMIC ECJ0EB1E102K	T
C601	4550006210	S.TANTALUM ECST1CX106R	T
C602	4550006250	S.TANTALUM TEESVA 1A 106M8L	B
J1	6450002210	CONNECTOR 3017-8821 <KIN>	T
J3	6510024230	S.CONNECTOR 08-6210-0363-40-800	B
J4	6510021970	S.CONNECTOR AXN330C130P	B
DS1	5030002660	LCD IS08264E00V2	T
DS2	5040001760	S.LED SEC 2422C	T
DS3	5040001760	S.LED SEC 2422C	T
DS4	5040001760	S.LED SEC 2422C	T
DS5	5040001760	S.LED SEC 2422C	T
DS6	5040001760	S.LED SEC 2422C	T
DS7	5040001760	S.LED SEC 2422C	T
DS8	5040001760	S.LED SEC 2422C	T
DS9	5040001760	S.LED SEC 2422C	T
DS10	5040001760	S.LED SEC 2422C	T
DS11	5040001760	S.LED SEC 2422C	T
DS12	5040001760	S.LED SEC 2422C	T
DS13	5040001760	S.LED SEC 2422C	T
S1	2260001890	S.SWITCH SKQDPA	T
S2	2260001890	S.SWITCH SKQDPA	T
S3	2260001890	S.SWITCH SKQDPA	T
S4	2260001890	S.SWITCH SKQDPA	T
S5	2260001890	S.SWITCH SKQDPA	T
S6	2260001890	S.SWITCH SKQDPA	T
S7	2260001890	S.SWITCH SKQDPA	T
S8	2260001890	S.SWITCH SKQDPA	T
S9	2250000460	ENCODER EVQ-VENF0224B	T
S10	2260001890	S.SWITCH SKQDPA	T
EP1	6910012350	S.BEAD MMZ1608Y 102BT	T
EP2	6910012350	S.BEAD MMZ1608Y 102BT	B
EP3	6910012350	S.BEAD MMZ1608Y 102BT	B
EP4	6910012350	S.BEAD MMZ1608Y 102BT	B
EP5	6910012350	S.BEAD MMZ1608Y 102BT	T
EP6	6910012350	S.BEAD MMZ1608Y 102BT	B
EP7	6910012350	S.BEAD MMZ1608Y 102BT	B
EP8	6910012350	S.BEAD MMZ1608Y 102BT	B
EP9	6910012350	S.BEAD MMZ1608Y 102BT	B
EP10	6910012350	S.BEAD MMZ1608Y 102BT	B
EP11	8930062251	LCD CONTACT SRCN-2698-SP-N-W-1	T

S.=Surface mount

[LOGIC UNIT]

REF NO.	ORDER NO.	DESCRIPTION	M.
EP12	0910057732	PCB B 6048B	

[MAIN UNIT]

REF NO.	ORDER NO.	DESCRIPTION	M.
IC1	1130008350	S.IC LV2105V-TLM	B
IC2	1130011760	S.IC CD4094BPWR	T
IC4	1110003490	S.IC TA31136FN (D,EL)	B
IC5	1190000350	S.IC M62363FP-650C	B
IC6	1110004050	S.IC NJM3404AV-TE1	B
IC7	1180001250	S.IC TA7808F (TE16L)	B
IC8	1180000970	S.IC AN78L05M-(E1)	B
IC9	1110002550	IC TA7252AP	T
IC10	1150002180	S.IC S-AV36 (I)	T
IC11	1110004050	S.IC NJM3404AV-TE1	T
IC12	1130011780	S.IC SN74AHC2G53HDCTR	T
Q1	1530002850	S.TRANSISTOR 2SC4116-BL (TE85R)	B
Q2	1590001650	S.TRANSISTOR XP4601 (TX)	B
Q3	1530002850	S.TRANSISTOR 2SC4116-BL (TE85R)	B
Q4	1530002850	S.TRANSISTOR 2SC4116-BL (TE85R)	B
Q5	1530002850	S.TRANSISTOR 2SC4116-BL (TE85R)	B
Q6	1530002920	S.TRANSISTOR 2SC4226-T1 R25	T
Q7	1530002920	S.TRANSISTOR 2SC4226-T1 R25	T
Q8	1590001040	S.TRANSISTOR DTA113ZU T106	B
Q9	1530002920	S.TRANSISTOR 2SC4226-T1 R25	T
Q10	1560000810	S.FET 2SK1069-4-TL	T
Q11	1530002920	S.TRANSISTOR 2SC4226-T1 R25	T
Q12	1530002920	S.TRANSISTOR 2SC4226-T1 R25	T
Q13	1590000720	S.TRANSISTOR DTA144EUA T106 except [EXP-1]	T
Q14	1510000590	S.TRANSISTOR 2SA1362-Y (TE85L)	T
Q15	1530002850	S.TRANSISTOR 2SC4116-BL (TE85R)	T
Q16	1530003220	S.TRANSISTOR 2SC4406-4-TL	B
Q17	1530000370	S.TRANSISTOR 2SC3356-T1B	B
Q19	1580000760	S.FET 3SK299-T1 U73	B
Q21	1590001010	S.TRANSISTOR DTB113ZK T146	T
Q22	1590000430	S.TRANSISTOR DTC144EUA T106	T
Q25	1590001010	S.TRANSISTOR DTB113ZK T146	B
Q26	1590000720	S.TRANSISTOR DTA144EUA T106	B
Q27	1580000760	S.FET 3SK299-T1 U73	B
Q28	1530002970	S.TRANSISTOR 2SC4684 (TE16R)	B
Q29	1530003090	S.TRANSISTOR 2SC4213-B (TE85R)	B
Q30	1510000890	S.TRANSISTOR DTA143TU T106	T
Q31	1590001320	S.TRANSISTOR DTC143ZUA T106	T
Q34	1530002850	S.TRANSISTOR 2SC4116-BL (TE85R)	B
Q35	1530002340	S.TRANSISTOR 2SC2954-T1	B
Q36	1590001040	S.TRANSISTOR DTA113ZU T106	T
Q37	1590001190	S.TRANSISTOR XP6501-(TX) .AB	T
Q38	1590001190	S.TRANSISTOR XP6501-(TX) .AB	T
Q39	1590000430	S.TRANSISTOR DTC144EUA T106	B
Q40	1590000430	S.TRANSISTOR DTC144EUA T106	B
Q41	1530003630	S.TRANSISTOR 2SC4617 TLS	B
D1	1790001250	S.DIODE MA2S111-(TX)	B
D2	1750000720	S.VARICAP HVC375BTRF	T
D3	1750000770	S.VARICAP HVC376BTRF	T
D4	1720000730	S.VARICAP MA2S30400L	T
D5	1720000730	S.VARICAP MA2S30400L	T
D6	1790000620	S.DIODE MA77 (TX)	B
D7	1790000620	S.DIODE MA77 (TX)	B
D9	1750000710	S.VARICAP HVC350BTRF	B
D10	1750000710	S.VARICAP HVC350BTRF	B
D11	1750000710	S.VARICAP HVC350BTRF	B
D12	1710001060	DIODE XB15A407	T
D13	1750000710	S.VARICAP HVC350BTRF	B
D14	1790000980	S.DIODE MA742 (TX)	T
D15	1750000550	S.DIODE 1SS355 TE-17	T
D16	1710000870	S.DIODE HVU131TRF	T
D17	1790000980	S.DIODE MA742 (TX)	T
D18	1790001250	S.DIODE MA2S111-(TX)	B
D19	1710001080	DIODE XB15A308	T
D20	1730000520	ZENER RD20E B2	T
D21	1790000700	DIODE DSA3A1	T
D23	1790001250	S.DIODE MA2S111-(TX) except [EXP-1]	B
D24	1790001250	S.DIODE MA2S111-(TX) except [EXP-1]	T
D25	1790001250	S.DIODE MA2S111-(TX) except [EXP-1]	T
D26	1790001250	S.DIODE MA2S111-(TX) except [EXP-1]	B
D27	1710001060	DIODE XB15A407	T
D29	1750000370	S.DIODE DA221 TL	B

[MAIN UNIT]

REF NO.	ORDER NO.	DESCRIPTION	M.
D30	1750000550	S.DIODE 1SS355 TE-17	B
D31	1790001250	S.DIODE MA2S111-(TX)	B
D38	1720000730	S.VARICAP MA2S30400L	T
F11	2020001520	CERAMIC CFWLA450KFFA-B0 (CFWS450F)	T
F12	2020001460	CERAMIC CFWLA450KHFA-B0 (CFWS450HT) except [EXP-1]	T
F13	2030000270	MONOLITH FL-363 (21.7 MHz)	T
F14	2030000270	MONOLITH FL-363 (21.7 MHz)	T
X1	6050011870	S.XTAL CR-779 (21.250 MHz)	T
X2	6070000200	DISCRIMINATOR CDBLA450KCAY24-B0 (CDB450C24)	T
L1	6200009350	S.COIL ELJRE R22G-F3	T
L2	6200003640	S.COIL MLF1608E 100K-T	T
L3	6200001620	S.COIL ELJFC 1R0K-F	B
L6	6200009920	S.COIL C2012C-R10G	T
L7	6200010570	S.COIL C6342A-R11J-A	T
L8	6200004870	S.COIL ELJFC 2R7K-F	T
L9	6200004880	S.COIL ELJFC 3R3K-F	T
L10	6200001620	S.COIL ELJFC 1R0K-F	B
L11	6200009350	S.COIL ELJRE R22G-F3	T
L12	6200009350	S.COIL ELJRE R22G-F3	T
L13	6200006980	S.COIL ELJRE R10G-F	T
L14	6200006990	S.COIL ELJRE 56NG-F	B
L15	6200007000	S.COIL ELJRE 82NG-F	T
L18	6200005730	S.COIL ELJRE 39NG-F	B
L19	6200004920	S.COIL MLF1608A 2R2K-T	B
L20	6200005740	S.COIL ELJRE 47NG-F	B
L21	6200006670	S.COIL ELJRE 68NG-F	B
L22	6200006670	S.COIL ELJRE 68NG-F	B
L25	6200003280	S.COIL NL 252018T-2R2J	B
L26	6200003280	S.COIL NL 252018T-2R2J	B
L31	6200009890	S.COIL C2012C-82NG	T
L32	6200009890	S.COIL C2012C-82NG	T
L37	6200010050	S.COIL AS080547-47N	T
L38	6200009930	S.COIL C2012C-68NG	T
L39	6200010050	S.COIL AS080547-47N	T
L40	6200010420	S.COIL FHW1210HC 1R0JGT	T
L42	6200007370	S.COIL ELJFC R82K-F	B
L43	6200009460	S.COIL 0.25-1.9-7TL 67N	T
L45	6200008150	S.COIL 0.35-1.6-7TL 44N	T
L46	6200010060	S.COIL AS080647-56N	T
L47	6200010060	S.COIL AS080647-56N	T
L48	6200010060	S.COIL AS080647-56N	T
L52	6200002650	S.COIL NL 252018T-R18J	B
L56	6200006670	S.COIL ELJRE 68NG-F	B
L57	6190001520	S.COIL ZBFS5101-PT	T
L58	6190001520	S.COIL ZBFS5101-PT	T
L59	6190001520	S.COIL ZBFS5101-PT	T
L60	6190001520	S.COIL ZBFS5101-PT	T
L61	6200003640	S.COIL MLF1608E 100K-T	T
L62	6200003640	S.COIL MLF1608E 100K-T	T
R1	7030003660	S.RESISTOR ERJ3GEYJ 683 V (68 kΩ)	T
R2	7030003440	S.RESISTOR ERJ3GEYJ 102 V (1 kΩ)	T
R3	7030003760	S.RESISTOR ERJ3GEYJ 474 V (470 kΩ)	T
R4	7030003280	S.RESISTOR ERJ3GEYJ 470 V (47 Ω)	T
R5	7030003310	S.RESISTOR ERJ3GEYJ 820 V (82 Ω)	T
R6	7030003400	S.RESISTOR ERJ3GEYJ 472 V (4.7 kΩ)	B
R7	7510001660	S.THRMISTOR NTCG16 4LH 473KT	T
R8	7030003680	S.RESISTOR ERJ3GEYJ 104 V (100 kΩ)	T
R9	7030003560	S.RESISTOR ERJ3GEYJ 103 V (10 kΩ)	B
R10	7030003640	S.RESISTOR ERJ3GEYJ 473 V (47 kΩ)	T
R11	7030003560	S.RESISTOR ERJ3GEYJ 103 V (10 kΩ)	B
R12	7030003320	S.RESISTOR ERJ3GEYJ 101 V (100 Ω)	B
R13	7030003490	S.RESISTOR ERJ3GEYJ 272 V (2.7 kΩ)	B
R14	7030003800	S.RESISTOR ERJ3GEYJ 105 V (1 MΩ)	B
R15	7030003730	S.RESISTOR ERJ3GEYJ 274 V (270 kΩ)	B
R16	7030003600	S.RESISTOR ERJ3GEYJ 223 V (22 kΩ)	B
R17	7030003720	S.RESISTOR ERJ3GEYJ 224 V (220 kΩ)	B
R18	7030003390	S.RESISTOR ERJ3GEYJ 391 V (390 Ω)	B
R19	7030003550	S.RESISTOR ERJ3GEYJ 822 V (8.2 kΩ)	T
R20	7030003530	S.RESISTOR ERJ3GEYJ 562 V (5.6 kΩ)	T
R21	7030003320	S.RESISTOR ERJ3GEYJ 101 V (100 Ω)	B
R22	7030003440	S.RESISTOR ERJ3GEYJ 102 V (1 kΩ)	B
R23	7030003600	S.RESISTOR ERJ3GEYJ 223 V (22 kΩ)	T
R24	7030003480	S.RESISTOR ERJ3GEYJ 222 V (2.2 kΩ)	B
R25	7030003560	S.RESISTOR ERJ3GEYJ 103 V (10 kΩ)	T
R26	7030003560	S.RESISTOR ERJ3GEYJ 103 V (10 kΩ)	B
R27	7030003470	S.RESISTOR ERJ3GEYJ 182 V (1.8 kΩ)	T
R28	7030003440	S.RESISTOR ERJ3GEYJ 102 V (1 kΩ)	T
R29	7030003560	S.RESISTOR ERJ3GEYJ 103 V (10 kΩ)	B

M.=Mounted side (T: Mounted on the Top side, B: Mounted on the Bottom side)

S.=Surface mount

[MAIN UNIT]

REF NO.	ORDER NO.	DESCRIPTION	M.
R30	7030003490	S.RESISTOR ERJ3GEYJ 272 V (2.7 kΩ)	T
R31	7030003440	S.RESISTOR ERJ3GEYJ 102 V (1 kΩ)	T
R32	7030003200	S.RESISTOR ERJ3GEYJ 100 V (10 Ω)	T
R33	7030003200	S.RESISTOR ERJ3GEYJ 100 V (10 Ω)	T
R34	7030003680	S.RESISTOR ERJ3GEYJ 104 V (100 kΩ)	T
R35	7030003380	S.RESISTOR ERJ3GEYJ 331 V (330 Ω)	T
R36	7030003440	S.RESISTOR ERJ3GEYJ 102 V (1 kΩ)	T
R37	7030003640	S.RESISTOR ERJ3GEYJ 473 V (47 kΩ)	T
R39	7030003680	S.RESISTOR ERJ3GEYJ 104 V (100 kΩ)	T
R40	7030003680	S.RESISTOR ERJ3GEYJ 104 V (100 kΩ)	T
R41	7030003400	S.RESISTOR ERJ3GEYJ 471 V (470 Ω)	T
R42	7030003400	S.RESISTOR ERJ3GEYJ 471 V (470 Ω)	T
R43	7030003550	S.RESISTOR ERJ3GEYJ 822 V (8.2 kΩ)	T
R44	7030003320	S.RESISTOR ERJ3GEYJ 101 V (100 Ω)	B
R45	7030003680	S.RESISTOR ERJ3GEYJ 104 V (100 kΩ)	T
R46	7030003420	S.RESISTOR ERJ3GEYJ 681 V (680 Ω)	B
R47	7030003480	S.RESISTOR ERJ3GEYJ 222 V (2.2 kΩ)	T
R48	7030003480	S.RESISTOR ERJ3GEYJ 222 V (2.2 kΩ)	T
R49	7030003520	S.RESISTOR ERJ3GEYJ 472 V (4.7 kΩ)	B
R50	7030003520	S.RESISTOR ERJ3GEYJ 472 V (4.7 kΩ)	B
R51	7030003520	S.RESISTOR ERJ3GEYJ 472 V (4.7 kΩ)	B
R52	7030003460	S.RESISTOR ERJ3GEYJ 152 V (1.5 kΩ)	B
R54	7030003240	S.RESISTOR ERJ3GEYJ 220 V (22 Ω)	B
R55	7030003640	S.RESISTOR ERJ3GEYJ 473 V (47 kΩ)	B
R56	7030003400	S.RESISTOR ERJ3GEYJ 471 V (470 Ω)	B
R57	7030003620	S.RESISTOR ERJ3GEYJ 333 V (33 kΩ)	B
R58	7030003680	S.RESISTOR ERJ3GEYJ 104 V (100 kΩ)	B
R59	7030003480	S.RESISTOR ERJ3GEYJ 222 V (2.2 kΩ)	B
R60	7030003260	S.RESISTOR ERJ3GEYJ 330 V (33 Ω)	B
R62	7030003440	S.RESISTOR ERJ3GEYJ 102 V (1 kΩ)	B
R63	7030003360	S.RESISTOR ERJ3GEYJ 221 V (220 Ω)	B
R64	7030003680	S.RESISTOR ERJ3GEYJ 104 V (100 kΩ)	B
R66	7030003680	S.RESISTOR ERJ3GEYJ 104 V (100 kΩ)	B
R71	7030003400	S.RESISTOR ERJ3GEYJ 471 V (470 Ω)	B
R72	7030003460	S.RESISTOR ERJ3GEYJ 152 V (1.5 kΩ)	B
R73	7030003500	S.RESISTOR ERJ3GEYJ 332 V (3.3 kΩ)	B
R76	7030003320	S.RESISTOR ERJ3GEYJ 101 V (100 Ω)	B
R78	7030003440	S.RESISTOR ERJ3GEYJ 102 V (1 kΩ)	B
R79	7030003360	S.RESISTOR ERJ3GEYJ 221 V (220 Ω)	B
R81	7030003560	S.RESISTOR ERJ3GEYJ 103 V (10 kΩ)	B
R88	7030003400	S.RESISTOR ERJ3GEYJ 471 V (470 Ω)	B
R90	7030003720	S.RESISTOR ERJ3GEYJ 224 V (220 kΩ)	B
R92	7030003370	S.RESISTOR ERJ3GEYJ 271 V (270 Ω)	T
R93	7030003720	S.RESISTOR ERJ3GEYJ 224 V (220 kΩ)	B
R95	7030000230	S.RESISTOR MCR10EZJH 56 Ω (560)	T
R96	7030000410	S.RESISTOR MCR10EZJH 1.8 kΩ	T
R101	7030003720	S.RESISTOR ERJ3GEYJ 224 V (220 kΩ)	B
R103	7030003760	S.RESISTOR ERJ3GEYJ 474 V (470 kΩ)	B
R104	7030003440	S.RESISTOR ERJ3GEYJ 102 V (1 kΩ)	B
R106	7030003560	S.RESISTOR ERJ3GEYJ 103 V (10 kΩ)	B
R107	7030003520	S.RESISTOR ERJ3GEYJ 472 V (4.7 kΩ)	B
R108	7030003570	S.RESISTOR ERJ3GEYJ 123 V (12 kΩ)	B
R109	7030003510	S.RESISTOR ERJ3GEYJ 392 V (3.9 kΩ)	B
R110	7030003440	S.RESISTOR ERJ3GEYJ 102 V (1 kΩ)	B
R111	7030003320	S.RESISTOR ERJ3GEYJ 101 V (100 Ω)	T
R112	7030003620	S.RESISTOR ERJ3GEYJ 333 V (33 kΩ)	T
R113	7030003440	S.RESISTOR ERJ3GEYJ 102 V (1 kΩ)	B
R114	7030003640	S.RESISTOR ERJ3GEYJ 473 V (47 kΩ)	B
R117	7030003560	S.RESISTOR ERJ3GEYJ 103 V (10 kΩ)	B
R118	7030003560	S.RESISTOR ERJ3GEYJ 103 V (10 kΩ)	B
R119	7030003720	S.RESISTOR ERJ3GEYJ 224 V (220 kΩ)	B
R120	7030003560	S.RESISTOR ERJ3GEYJ 103 V (10 kΩ)	T
R121	7030000260	S.RESISTOR MCR10EZJH 100 Ω (101)	T
R122	7030003640	S.RESISTOR ERJ3GEYJ 473 V (47 kΩ)	B
R123	7030003540	S.RESISTOR ERJ3GEYJ 682 V (6.8 kΩ)	B
R124	7030003550	S.RESISTOR ERJ3GEYJ 822 V (8.2 kΩ)	T
R125	7030003240	S.RESISTOR ERJ3GEYJ 220 V (22 Ω)	T
R126	7030003550	S.RESISTOR ERJ3GEYJ 822 V (8.2 kΩ)	T
R127	7030003690	S.RESISTOR ERJ3GEYJ 124 V (120 kΩ)	B
R128	7030003680	S.RESISTOR ERJ3GEYJ 104 V (100 kΩ)	B
R129	7030003680	S.RESISTOR ERJ3GEYJ 104 V (100 kΩ)	B
R130	7030003610	S.RESISTOR ERJ3GEYJ 273 V (27 kΩ)	B
R131	7030003670	S.RESISTOR ERJ3GEYJ 823 V (82 kΩ)	B
R135	7030003570	S.RESISTOR ERJ3GEYJ 123 V (12 kΩ) except [EXP-1]	T
R136	7030003570	S.RESISTOR ERJ3GEYJ 123 V (12 kΩ) except [EXP-1]	T
R137	7030003570	S.RESISTOR ERJ3GEYJ 123 V (12 kΩ) except [EXP-1]	B
R138	7030003570	S.RESISTOR ERJ3GEYJ 123 V (12 kΩ) except [EXP-1]	B
R139	7030003580	S.RESISTOR ERJ3GEYJ 153 V (15 kΩ) except [EXP-1]	B
R140	7030003580	S.RESISTOR ERJ3GEYJ 153 V (15 kΩ) except [EXP-1]	T
R150	7030006070	S.RESISTOR ERJ12YJ101U (100 Ω)	T
R152	7030003280	S.RESISTOR ERJ3GEYJ 470 V (47 Ω)	B
R153	7030003330	S.RESISTOR ERJ3GEYJ 121 V (120 Ω)	B

[MAIN UNIT]

REF NO.	ORDER NO.	DESCRIPTION	M.
R154	7030003330	S.RESISTOR ERJ3GEYJ 121 V (120 Ω)	B
R155	7030003500	S.RESISTOR ERJ3GEYJ 332 V (3.3 kΩ)	B
R156	7030003640	S.RESISTOR ERJ3GEYJ 473 V (47 kΩ)	B
R157	7030003640	S.RESISTOR ERJ3GEYJ 473 V (47 kΩ)	B
R168	7030003370	S.RESISTOR ERJ3GEYJ 271 V (270 Ω)	B
R169	7030003230	S.RESISTOR ERJ3GEYJ 180 V (18 Ω)	B
R170	7030003370	S.RESISTOR ERJ3GEYJ 271 V (270 Ω)	B
R171	7030003440	S.RESISTOR ERJ3GEYJ 102 V (1 kΩ) except [EXP-1]	B
R172	7030003680	S.RESISTOR ERJ3GEYJ 104 V (100 kΩ) except [EXP-1]	T
R173	7030003560	S.RESISTOR ERJ3GEYJ 103 V (10 kΩ)	B
R174	7030003320	S.RESISTOR ERJ3GEYJ 101 V (100 Ω)	B
R175	7030003640	S.RESISTOR ERJ3GEYJ 473 V (47 kΩ)	T
R176	7030003440	S.RESISTOR ERJ3GEYJ 102 V (1 kΩ)	T
R177	7030003340	S.RESISTOR ERJ3GEYJ 151 V (150 Ω)	B
R178	7030003270	S.RESISTOR ERJ3GEYJ 390 V (39 Ω)	B
R179	7030003340	S.RESISTOR ERJ3GEYJ 151 V (150 Ω)	B
R180	7030003220	S.RESISTOR ERJ3GEYJ 150 V (15 Ω)	B
R181	7030003240	S.RESISTOR ERJ3GEYJ 220 V (22 Ω)	B
R182	7030003240	S.RESISTOR ERJ3GEYJ 220 V (22 Ω)	B
R183	7030003520	S.RESISTOR ERJ3GEYJ 472 V (4.7 kΩ)	B
R184	7030003440	S.RESISTOR ERJ3GEYJ 102 V (1 kΩ)	B
R185	7030003220	S.RESISTOR ERJ3GEYJ 150 V (15 Ω)	B
R186	7030005501	S.RESISTOR ERA3YKD 124V (120 kΩ)	T
R187	7030005501	S.RESISTOR ERA3YKD 124V (120 kΩ)	T
R188	7030003680	S.RESISTOR ERJ3GEYJ 104 V (100 kΩ)	T
R189	7030005981	S.RESISTOR ERA3YED 333V	T
R190	7030005981	S.RESISTOR ERA3YED 333V	T
R191	7030003730	S.RESISTOR ERJ3GEYJ 274 V (270 kΩ)	T
R192	7030003730	S.RESISTOR ERJ3GEYJ 274 V (270 kΩ)	T
R193	7030003740	S.RESISTOR ERJ3GEYJ 334 V (330 kΩ)	T
R194	7030003680	S.RESISTOR ERJ3GEYJ 104 V (100 kΩ)	T
R195	7030003680	S.RESISTOR ERJ3GEYJ 104 V (100 kΩ)	B
R201	7030003400	S.RESISTOR ERJ3GEYJ 471 V (470 Ω)	T
R202	7030003440	S.RESISTOR ERJ3GEYJ 102 V (1 kΩ)	T
R203	7030003710	S.RESISTOR ERJ3GEYJ 184 V (180 kΩ)	T
R204	7030003680	S.RESISTOR ERJ3GEYJ 104 V (100 kΩ)	T
R205	7030003740	S.RESISTOR ERJ3GEYJ 334 V (330 kΩ)	T
R207	7030003710	S.RESISTOR ERJ3GEYJ 184 V (180 kΩ)	T
R208	7030003780	S.RESISTOR ERJ3GEYJ 684 V (680 kΩ)	T
R209	7030003320	S.RESISTOR ERJ3GEYJ 101 V (100 Ω)	T
R212	7030003600	S.RESISTOR ERJ3GEYJ 223 V (22 kΩ)	T
R213	7030003200	S.RESISTOR ERJ3GEYJ 100 V (10 Ω)	T
R214	7030003560	S.RESISTOR ERJ3GEYJ 103 V (10 kΩ)	B
R220	7030003740	S.RESISTOR ERJ3GEYJ 334 V (330 kΩ)	T
R221	7030003770	S.RESISTOR ERJ3GEYJ 564 V (560 kΩ)	T
R223	7030003640	S.RESISTOR ERJ3GEYJ 473 V (47 kΩ)	T
R224	7030003860	S.RESISTOR ERJ3GE JPW V [EXP-1] only	B
R225	7030003860	S.RESISTOR ERJ3GE JPW V [EXP-1] only	T
R226	7030003860	S.RESISTOR ERJ3GE JPW V	B
R228	7520000120	POSISTOR PTFM04BC222Q2N34B0	T
R229	7030003860	S.RESISTOR ERJ3GE JPW V	B
R230	7030003640	S.RESISTOR ERJ3GEYJ 473 V (47 kΩ)	B
R231	7030003860	S.RESISTOR ERJ3GE JPW V	T
R232	7030003680	S.RESISTOR ERJ3GEYJ 104 V (100 kΩ)	T
R233	7030003860	S.RESISTOR ERJ3GE JPW V	B
R234	7030011140	RESISTOR ERJ8GEYJ JPW	T
R236	7030003860	S.RESISTOR ERJ3GE JPW V	B
R237	7030003640	S.RESISTOR ERJ3GEYJ 473 V (47 kΩ)	T
R238	7030003640	S.RESISTOR ERJ3GEYJ 473 V (47 kΩ)	T
C1	4550006160	S.TANTALUM ECST1CY155R	B
C2	4030006860	S.CERAMIC C1608 JB 1H 102K-T	B
C4	4030011600	S.CERAMIC C1608 JB 1E 104K-T	T
C5	4030006900	S.CERAMIC C1608 JB 1H 103K-T	T
C7	4030006860	S.CERAMIC C1608 JB 1H 102K-T	T
C8	4030006860	S.CERAMIC C1608 JB 1H 102K-T	T
C9	4030007060	S.CERAMIC C1608 CH 1H 270J-T	T
C10	4510004640	S.ELECTROLYTIC ECEV1CA470SP	T
C11	4550006250	S.TANTALUM TEESVA 1A 106M8L	B
C12	4550007060	S.TANTALUM ECSTIAX336R	B
C13	4030007030	S.CERAMIC C1608 CH 1H 150J-T	T
C14	4030006860	S.CERAMIC C1608 JB 1H 102K-T	B
C15	4030006860	S.CERAMIC C1608 JB 1H 102K-T	B
C16	4030007020	S.CERAMIC C1608 CH 1H 120J-T	T
C17	4030006860	S.CERAMIC C1608 JB 1H 102K-T	B
C20	4030007090	S.CERAMIC C1608 CH 1H 470J-T	T
C21	4030007050	S.CERAMIC C1608 CH 1H 220J-T	T
C22	4030007060	S.CERAMIC C1608 CH 1H 270J-T	B
C23	4030007070	S.CERAMIC C1608 CH 1H 330J-T	B
C24	4550006250	S.TANTALUM TEESVA 1A 106M8L	B
C25	4030009920	S.CERAMIC C1608 CH 1H 050B-T	T
C26	4030007010	S.CERAMIC C1608 CH 1H 100D-T	T
C28	4030006860	S.CERAMIC C1608 JB 1H 102K-T	T
C29	4030006980	S.CERAMIC C1608 CH 1H 070D-T	T
C30	4030006950	S.CERAMIC C1608 CH 1H 040C-T	B

M.=Mounted side (T: Mounted on the Top side, B: Mounted on the Bottom side)

S.=Surface mount

[MAIN UNIT]

REF NO.	ORDER NO.	DESCRIPTION	M.
C31	4030006860	S.CERAMIC C1608 JB 1H 102K-T	T
C32	4030007020	S.CERAMIC C1608 CH 1H 120J-T	T
C34	4030009500	S.CERAMIC C1608 CH 1H 0R5B-T	T
C36	4030006860	S.CERAMIC C1608 JB 1H 102K-T	T
C37	4030009500	S.CERAMIC C1608 CH 1H 0R5B-T	T
C38	4030006860	S.CERAMIC C1608 JB 1H 102K-T	T
C39	4030011600	S.CERAMIC C1608 JB 1E 104K-T	B
C40	4030006860	S.CERAMIC C1608 JB 1H 102K-T	T
C41	4030006860	S.CERAMIC C1608 JB 1H 102K-T	T
C42	4030006860	S.CERAMIC C1608 JB 1H 102K-T	T
C44	4030006860	S.CERAMIC C1608 JB 1H 102K-T	T
C45	4030006860	S.CERAMIC C1608 JB 1H 102K-T	B
C47	4030011600	S.CERAMIC C1608 JB 1E 104K-T	B
C48	4030006860	S.CERAMIC C1608 JB 1H 102K-T	T
C49	4030007010	S.CERAMIC C1608 CH 1H 100D-T	T
C50	4030006940	S.CERAMIC C1608 CH 1H 030C-T	T
C51	4030006860	S.CERAMIC C1608 JB 1H 102K-T	T
C52	4030006860	S.CERAMIC C1608 JB 1H 102K-T	T
C53	4030006860	S.CERAMIC C1608 JB 1H 102K-T	B
C54	4030007000	S.CERAMIC C1608 CH 1H 090D-T	T
C55	4030007050	S.CERAMIC C1608 CH 1H 220J-T	T
C56	4030006860	S.CERAMIC C1608 JB 1H 102K-T	T
C57	4030006860	S.CERAMIC C1608 JB 1H 102K-T	T
C58	4030006860	S.CERAMIC C1608 JB 1H 102K-T	T
C59	4030006860	S.CERAMIC C1608 JB 1H 102K-T	T
C60	4030006860	S.CERAMIC C1608 JB 1H 102K-T	B
C61	4030007050	S.CERAMIC C1608 CH 1H 220J-T	B
C62	4030007020	S.CERAMIC C1608 CH 1H 120J-T	T
C63	4030006860	S.CERAMIC C1608 JB 1H 102K-T	T
C64	4030011600	S.CERAMIC C1608 JB 1E 104K-T	T
C65	4030007050	S.CERAMIC C1608 CH 1H 220J-T	B
C66	4030007050	S.CERAMIC C1608 CH 1H 220J-T	B
C67	4030006860	S.CERAMIC C1608 JB 1H 102K-T	B
C68	4030007000	S.CERAMIC C1608 CH 1H 090D-T	T
C69	4510004630	S.ELECTROLYTIC ECEV1CA100SR	T
C70	4030006860	S.CERAMIC C1608 JB 1H 102K-T	T
C71	4030007090	S.CERAMIC C1608 CH 1H 470J-T	B
C72	4030006860	S.CERAMIC C1608 JB 1H 102K-T	T
C73	4030007050	S.CERAMIC C1608 CH 1H 220J-T	T
C74	4030006860	S.CERAMIC C1608 JB 1H 102K-T	B
C75	4030006860	S.CERAMIC C1608 JB 1H 102K-T	T
C76	4030006980	S.CERAMIC C1608 CH 1H 070D-T	T
C77	4030006900	S.CERAMIC C1608 JB 1H 103K-T	B
C78	4030011600	S.CERAMIC C1608 JB 1E 104K-T	B
C79	4030007080	S.CERAMIC C1608 CH 1H 390J-T	T
C80	4030007050	S.CERAMIC C1608 CH 1H 220J-T	B
C81	4030006900	S.CERAMIC C1608 JB 1H 103K-T	B
C82	4510004630	S.ELECTROLYTIC ECEV1CA100SR	T
C83	4030012600	S.CERAMIC C2012 JB 1A 105M-T	T
C84	4030007170	S.CERAMIC C1608 CH 1H 221J-T	T
C85	4030007170	S.CERAMIC C1608 CH 1H 221J-T	T
C86	4030006860	S.CERAMIC C1608 JB 1H 102K-T	T
C87	4030007100	S.CERAMIC C1608 CH 1H 560J-T	T
C88	4030007100	S.CERAMIC C1608 CH 1H 560J-T	B
C89	4030006900	S.CERAMIC C1608 JB 1H 103K-T	T
C90	4030007070	S.CERAMIC C1608 CH 1H 330J-T	T
C91	4030006860	S.CERAMIC C1608 JB 1H 102K-T	B
C93	4030006910	S.CERAMIC C1608 CH 1H 0R5C-T	T
C94	4030006860	S.CERAMIC C1608 JB 1H 102K-T	B
C95	4030006860	S.CERAMIC C1608 JB 1H 102K-T	B
C97	4030006960	S.CERAMIC C1608 CH 1H 050C-T	B
C98	4030008900	S.CERAMIC C1608 JB 1H 333K-T	T
C100	4030007120	S.CERAMIC C1608 CH 1H 820J-T	B
C101	4030006860	S.CERAMIC C1608 JB 1H 102K-T	B
C105	4030006860	S.CERAMIC C1608 JB 1H 102K-T	B
C108	4030006860	S.CERAMIC C1608 JB 1H 102K-T	B
C111	4030009990	S.CERAMIC C1608 CH 1H 200J-T	B
C113	4030006860	S.CERAMIC C1608 JB 1H 102K-T	B
C117	4030006900	S.CERAMIC C1608 JB 1H 103K-T	T
C118	4510004640	S.ELECTROLYTIC ECEV1CA470SP	T
C120	4030006900	S.CERAMIC C1608 JB 1H 103K-T	B
C122	4030006860	S.CERAMIC C1608 JB 1H 102K-T	T
C123	4030006860	S.CERAMIC C1608 JB 1H 102K-T	T
C124	4030006960	S.CERAMIC C1608 CH 1H 050C-T	B
C125	4510004630	S.ELECTROLYTIC ECEV1CA100SR	T
C127	4030006920	S.CERAMIC C1608 CH 1H 010C-T	T
C128	4030006860	S.CERAMIC C1608 JB 1H 102K-T	B
C131	4030007120	S.CERAMIC C1608 CH 1H 820J-T	B
C133	4030006920	S.CERAMIC C1608 CH 1H 010C-T	T
C134	4030006860	S.CERAMIC C1608 JB 1H 102K-T	B
C136	4030009560	S.CERAMIC C1608 CH 1H R75B-T	B
C137	4030006860	S.CERAMIC C1608 JB 1H 102K-T	T
C138	4030006860	S.CERAMIC C1608 JB 1H 102K-T	B
C139	4030007120	S.CERAMIC C1608 CH 1H 820J-T	B
C140	4030006900	S.CERAMIC C1608 JB 1H 103K-T	B
C141	4030006930	S.CERAMIC C1608 CH 1H 020C-T	T
C145	4030006920	S.CERAMIC C1608 CH 1H 010C-T	B
C146	4030006860	S.CERAMIC C1608 JB 1H 102K-T	B

[MAIN UNIT]

REF NO.	ORDER NO.	DESCRIPTION	M.
C148	4030007150	S.CERAMIC C1608 CH 1H 151J-T	B
C149	4030011600	S.CERAMIC C1608 JB 1E 104K-T	B
C152	4030009510	S.CERAMIC C1608 CH 1H 010B-T	B
C153	4030011600	S.CERAMIC C1608 JB 1E 104K-T	B
C154	4030006860	S.CERAMIC C1608 JB 1H 102K-T	B
C157	4510006250	S.ELECTROLYTIC ECEV1CA331UP	T
C158	4030006860	S.CERAMIC C1608 JB 1H 102K-T	B
C160	4030006860	S.CERAMIC C1608 JB 1H 102K-T	B
C161	4030006860	S.CERAMIC C1608 JB 1H 102K-T	T
C162	4030009550	S.CERAMIC C1608 CH 1H 2R5B-T	B
C163	4030006860	S.CERAMIC C1608 JB 1H 102K-T	B
C164	4030006860	S.CERAMIC C1608 JB 1H 102K-T	B
C166	4510006220	S.ELECTROLYTIC ECEV1CA101UP	T
C168	4030006860	S.CERAMIC C1608 JB 1H 102K-T	B
C169	4030006860	S.CERAMIC C1608 JB 1H 102K-T	B
C170	4030006860	S.CERAMIC C1608 JB 1H 102K-T	B
C172	4030006860	S.CERAMIC C1608 JB 1H 102K-T	B
C173	4030006860	S.CERAMIC C1608 JB 1H 102K-T	B
C174	4030006860	S.CERAMIC C1608 JB 1H 102K-T	T
C175	4510006250	S.ELECTROLYTIC ECEV1CA331UP	T
C176	4030011040	S.CERAMIC GRM31M4C2H2R0CY21L	T
C177	4510004630	S.ELECTROLYTIC ECEV1CA100SR	T
C178	4030006950	S.CERAMIC C1608 CH 1H 040C-T	B
C179	4030006860	S.CERAMIC C1608 JB 1H 102K-T	T
C180	4030006860	S.CERAMIC C1608 JB 1H 102K-T	T
C181	4510004440	S.ELECTROLYTIC ECEV1HA010SR	T
C182	4030007150	S.CERAMIC C1608 CH 1H 151J-T	B
C184	4030006960	S.CERAMIC C1608 CH 1H 050C-T	B
C185	4030006860	S.CERAMIC C1608 JB 1H 102K-T	B
C187	4030006860	S.CERAMIC C1608 JB 1H 102K-T	B
C188	4510004440	S.ELECTROLYTIC ECEV1HA010SR	T
C189	4030006860	S.CERAMIC C1608 JB 1H 102K-T	B
C190	4030011020	S.CERAMIC GRM31M4C2H1R0CY21L	T
C191	4030007020	S.CERAMIC C1608 CH 1H 120J-T	T
C192	4030006860	S.CERAMIC C1608 JB 1H 102K-T	T
C193	4030006860	S.CERAMIC C1608 JB 1H 102K-T	B
C194	4510006220	S.ELECTROLYTIC ECEV1CA101UP	T
C195	4510004640	S.ELECTROLYTIC ECEV1CA470SP	T
C196	4030011020	S.CERAMIC GRM31M4C2H1R0CY21L	T
C197	4030007020	S.CERAMIC C1608 CH 1H 120J-T	T
C198	4030006860	S.CERAMIC C1608 JB 1H 102K-T	T
C200	4030006860	S.CERAMIC C1608 JB 1H 102K-T	T
C201	4030007050	S.CERAMIC C1608 CH 1H 220J-T	T
C204	4510006260	S.ELECTROLYTIC ECEV1AA471UP	T
C205	4030006860	S.CERAMIC C1608 JB 1H 102K-T	B
C206	4030011110	S.CERAMIC GRM31M2C2H9R0DV01L	T
C207	4510006020	ELECTROLYTIC 16 MV 2200 HC	T
C208	4030011210	S.CERAMIC GRM31M2C2H330JV01L	T
C209	4030011600	S.CERAMIC C1608 JB 1E 104K-T	B
C210	4030011160	S.CERAMIC GRM31M2C2H150JV01	T
C211	4030006860	S.CERAMIC C1608 JB 1H 102K-T	B
C212	4030006860	S.CERAMIC C1608 JB 1H 102K-T	B
C215	4030011600	S.CERAMIC C1608 JB 1E 104K-T	T
C216	4030011600	S.CERAMIC C1608 JB 1E 104K-T	T
C217	4030011230	S.CERAMIC GRM31M2C2H390JV01L	T
C218	4030011190	S.CERAMIC GRM31M2C2H270JV01L	T
C221	4030010780	S.CERAMIC C1608 CH 1H 1R5C-T	T
C222	4030006900	S.CERAMIC C1608 JB 1H 103K-T	B
C224	4030011600	S.CERAMIC C1608 JB 1E 104K-T	B
C225	4030017200	S.CERAMIC GRM31BR32J102KY01L	T
C227	4030011210	S.CERAMIC GRM31M2C2H330JV01L	T
C228	4030006900	S.CERAMIC C1608 JB 1H 103K-T	T
C230	4510004630	S.ELECTROLYTIC ECEV1CA100SR except [EXP-1]	T
C232	4030011600	S.CERAMIC C1608 JB 1E 104K-T	B
C233	4030011600	S.CERAMIC C1608 JB 1E 104K-T	B
C240	4030006860	S.CERAMIC C1608 JB 1H 102K-T	B
C241	4030011600	S.CERAMIC C1608 JB 1E 104K-T	B
C242	4030006860	S.CERAMIC C1608 JB 1H 102K-T	B
C243	4030017810	S.CERAMIC C1608 CH 1H 102J-T	B
C244	4030011600	S.CERAMIC C1608 JB 1E 104K-T	B
C245	4030008680	S.CERAMIC C2012 JF 1C 105Z-T	B
C246	4030006860	S.CERAMIC C1608 JB 1H 102K-T	T
C247	4030006860	S.CERAMIC C1608 JB 1H 102K-T	T
C250	4030007100	S.CERAMIC C1608 CH 1H 560J-T	B
C251	4030006860	S.CERAMIC C1608 JB 1H 102K-T	B
C252	4030006860	S.CERAMIC C1608 JB 1H 102K-T	B
C253	4030007020	S.CERAMIC C1608 CH 1H 120J-T	B
C254	4550006080	S.TANTALUM TEESVB2 1C 106M8L	B
C255	4030006860	S.CERAMIC C1608 JB 1H 102K-T	T
C256	4030006860	S.CERAMIC C1608 JB 1H 102K-T	T
C257	4030006860	S.CERAMIC C1608 JB 1H 102K-T	T
C258	4030006860	S.CERAMIC C1608 JB 1H 102K-T	T
C259	4030006860	S.CERAMIC C1608 JB 1H 102K-T	T
C265	4030006860	S.CERAMIC C1608 JB 1H 102K-T	T
C266	4030006860	S.CERAMIC C1608 JB 1H 102K-T	T
C267	4030006860	S.CERAMIC C1608 JB 1H 102K-T	T
C268	4030006900	S.CERAMIC C1608 JB 1H 103K-T	T
C269	4030006900	S.CERAMIC C1608 JB 1H 103K-T	T

M.=Mounted side (T: Mounted on the Top side, B: Mounted on the Bottom side)

S.=Surface mount

[MAIN UNIT]

REF NO.	ORDER NO.	DESCRIPTION		M.
C271	4550006140	S.TANTALUM	ECST1EY474R	T
C272	4030011600	S.CERAMIC	C1608 JB 1E 104K-T	T
C273	4550006480	S.TANTALUM	TEESVA 1C 475M8L	T
C278	4510004540	S.ELECTROLYTIC	ECEV0JA470SR	T
C279	4510004440	S.ELECTROLYTIC	ECEV1HA010SR	T
C280	4550006130	S.TANTALUM	ECST1VY224R	B
C281	4510005830	S.ELECTROLYTIC	ECEV1HAN010R	T
C282	4030006860	S.CERAMIC	C1608 JB 1H 102K-T	B
C283	4030006860	S.CERAMIC	C1608 JB 1H 102K-T	B
C284	4030008880	S.CERAMIC	C1608 JB 1H 223K-T	B
C285	4030008920	S.CERAMIC	C1608 JB 1H 473K-T	B
			except [EXP-1]	T
C286	4030006860	S.CERAMIC	C1608 JB 1H 102K-T	B
C287	4030017810	S.CERAMIC	C1608 CH 1H 102J-T	B
C288	4030011810	S.CERAMIC	C1608 JB 1A 224K-T	B
C289	4030006860	S.CERAMIC	C1608 JB 1H 102K-T	T
C290	4030006860	S.CERAMIC	C1608 JB 1H 102K-T	T
C291	4030006860	S.CERAMIC	C1608 JB 1H 102K-T	T
C292	4030006860	S.CERAMIC	C1608 JB 1H 102K-T	T
C293	4030006860	S.CERAMIC	C1608 JB 1H 102K-T	B
C294	4030006860	S.CERAMIC	C1608 JB 1H 102K-T	B
C295	4030006850	S.CERAMIC	C1608 JB 1H 471K-T	T
C296	4030006860	S.CERAMIC	C1608 JB 1H 102K-T	T
C297	4030006860	S.CERAMIC	C1608 JB 1H 102K-T	B
C299	4030012600	S.CERAMIC	C2012 JB 1A 105M-T	T
C300	4030006860	S.CERAMIC	C1608 JB 1H 102K-T	T
C301	4030006860	S.CERAMIC	C1608 JB 1H 102K-T	T
C302	4030006860	S.CERAMIC	C1608 JB 1H 102K-T	T
J4	6450002220	CONNECTOR	PJ-0008P-5 <KUG>	B
J6	6510014960	S.CONNECTOR	B2B-ZR-SM3-TF	T
J7	6450001430	CONNECTOR	HSJ1462-01-010	B
J11	6510024240	S.CONNECTOR	04-6274-036-000-800	T
W1	8900011880	CABLE	OPC-1210 (P=0.5 N=36 L=70)	
W5	7120000470	JUMPER	ERDS2T0	
W6	8900010980	CABLE	OPC-1131 <CMI>	
EP1	6910012350	S.BEAD	MMZ1608Y 102BT	B
EP2	6910012350	S.BEAD	MMZ1608Y 102BT	B
EP3	6910012350	S.BEAD	MMZ1608Y 102BT	T
EP4	6910012350	S.BEAD	MMZ1608Y 102BT	T
EP5	6910012350	S.BEAD	MMZ1608Y 102BT	B
EP6	6910012350	S.BEAD	MMZ1608Y 102BT	B
EP7	6910012350	S.BEAD	MMZ1608Y 102BT	T
EP8	6910012350	S.BEAD	MMZ1608Y 102BT	B
EP9	9040901901	TUBE	IRRAX 0.7 (d) L=12 mm	
EP10	0910057743	PCB	B 6076C	
EP11	6910000640	BEAD	FSRH090160RN000B	
EP12	6910000640	BEAD	FSRH090160RN000B [USA], [EUR], [EUR-1] only [USA], [EUR], [EUR-1] only	

6-2 HM-133V

[MAIN UNIT]

REF NO.	ORDER NO.	DESCRIPTION		M.
IC1	1140005870	S.IC	μPD7564AG-555-E1	B
IC2	1130008630	S.IC	MC14028BF-EL	B
IC3	11100006010	S.IC	S-80845CLUA-B66-T2	B
Q1	1530001940	S.TRANSISTOR	2SC2712-BL (TE85R)	B
Q2	1590000680	S.TRANSISTOR	DTC114EUA T106	B
Q3	1590001330	S.TRANSISTOR	DTA114EUA T106	B
Q4	1510000770	S.TRANSISTOR	2SA1586-GR (TE85R)	B
Q5	1510000770	S.TRANSISTOR	2SA1586-GR (TE85R)	B
Q6	1510000770	S.TRANSISTOR	2SA1586-GR (TE85R)	B
Q7	1510000770	S.TRANSISTOR	2SA1586-GR (TE85R)	B
Q8	1530001940	S.TRANSISTOR	2SC2712-BL (TE85R)	B
Q9	1590001010	S.TRANSISTOR	DTB113ZK T146	B
D1	1790000950	S.ZENER	MA8056-M (TX)	B
D3	1750000550	S.DIODE	1SS355 TE-17	B
D4	1750000550	S.DIODE	1SS355 TE-17	B
D5	1750000550	S.DIODE	1SS355 TE-17	B
D6	1750000550	S.DIODE	1SS355 TE-17	B
D7	1750000550	S.DIODE	1SS355 TE-17	B
D8	1750000550	S.DIODE	1SS355 TE-17	B
D9	1750000550	S.DIODE	1SS355 TE-17	B
D10	1750000550	S.DIODE	1SS355 TE-17	B
D11	1750000550	S.DIODE	1SS355 TE-17	B
D12	1750000550	S.DIODE	1SS355 TE-17	B
D13	1750000550	S.DIODE	1SS355 TE-17	B
D14	1750000550	S.DIODE	1SS355 TE-17	B
D15	1750000550	S.DIODE	1SS355 TE-17	B
D16	1730002280	S.ZENER	MA8091-M (TX)	B
D17	1730002280	S.ZENER	MA8091-M (TX)	B
D18	1730002280	S.ZENER	MA8091-M (TX)	B
D19	1750000550	S.DIODE	1SS355 TE-17	B
X1	6060000530	CERAMIC	CSBL600KJ28T-B0 (CSB600J200T)	B
L1	6200001520	S.COIL	MLF2012D R82K-T	B
L2	6200001520	S.COIL	MLF2012D R82K-T	B
R2	7030000400	S.RESISTOR	MCR10EZHZ 1.5 kΩ	B
R3	7030000400	S.RESISTOR	MCR10EZHZ 1.5 kΩ	B
R4	7030000400	S.RESISTOR	MCR10EZHZ 1.5 kΩ	B
R5	7030003400	S.RESISTOR	ERJ3GGEYJ 471 V (470 Ω)	B
R6	7030003620	S.RESISTOR	ERJ3GGEYJ 333 V (33 kΩ)	B
R7	7030003620	S.RESISTOR	ERJ3GGEYJ 333 V (33 kΩ)	B
R8	7030003570	S.RESISTOR	ERJ3GGEYJ 123 V (12 kΩ)	B
R9	7030003560	S.RESISTOR	ERJ3GGEYJ 103 V (10 kΩ)	B
R10	7030003420	S.RESISTOR	ERJ3GGEYJ 681 V (680 Ω)	B
R11	7030003420	S.RESISTOR	ERJ3GGEYJ 681 V (680 Ω)	B
R12	7030003560	S.RESISTOR	ERJ3GGEYJ 103 V (10 kΩ)	B
R13	7030003560	S.RESISTOR	ERJ3GGEYJ 103 V (10 kΩ)	B
R14	7030003420	S.RESISTOR	ERJ3GGEYJ 681 V (680 Ω)	B
R15	7030003400	S.RESISTOR	ERJ3GGEYJ 471 V (470 Ω)	B
R16	7030003560	S.RESISTOR	ERJ3GGEYJ 103 V (10 kΩ)	B
R18	7030003760	S.RESISTOR	ERJ3GGEYJ 474 V (470 kΩ)	B
R19	7030003760	S.RESISTOR	ERJ3GGEYJ 474 V (470 kΩ)	B
R20	7030003760	S.RESISTOR	ERJ3GGEYJ 474 V (470 kΩ)	B
R21	7030003760	S.RESISTOR	ERJ3GGEYJ 474 V (470 kΩ)	B
R22	7030003680	S.RESISTOR	ERJ3GGEYJ 104 V (100 kΩ)	B
R23	7030003680	S.RESISTOR	ERJ3GGEYJ 104 V (100 kΩ)	B
R24	7030003680	S.RESISTOR	ERJ3GGEYJ 104 V (100 kΩ)	B
R25	7030003680	S.RESISTOR	ERJ3GGEYJ 104 V (100 kΩ)	B
R26	7030003640	S.RESISTOR	ERJ3GGEYJ 473 V (47 kΩ)	B
R27	7030003800	S.RESISTOR	ERJ3GGEYJ 105 V (1 MΩ)	B
R29	7030003320	S.RESISTOR	ERJ3GGEYJ 101 V (100 Ω)	B
R30	7030003530	S.RESISTOR	ERJ3GGEYJ 562 V (5.6 kΩ)	B
R31	7030003640	S.RESISTOR	ERJ3GGEYJ 473 V (47 kΩ)	B
R32	7030003640	S.RESISTOR	ERJ3GGEYJ 473 V (47 kΩ)	B
R33	7030003640	S.RESISTOR	ERJ3GGEYJ 473 V (47 kΩ)	B
R34	7030003640	S.RESISTOR	ERJ3GGEYJ 473 V (47 kΩ)	B
R35	7030000400	S.RESISTOR	MCR10EZHZ 1.5 kΩ	B
R36	7030003560	S.RESISTOR	ERJ3GGEYJ 103 V (10 kΩ)	B
R37	7030003460	S.RESISTOR	ERJ3GGEYJ 152 V (1.5 kΩ)	B
R38	7030003720	S.RESISTOR	ERJ3GGEYJ 224 V (220 kΩ)	B
R39	7030003480	S.RESISTOR	ERJ3GGEYJ 222 V (2.2 kΩ)	B
R40	7030003480	S.RESISTOR	ERJ3GGEYJ 222 V (2.2 kΩ)	B
R41	7030003560	S.RESISTOR	ERJ3GGEYJ 103 V (10 kΩ)	B
C1	4030006850	S.CERAMIC	C1608 JB 1H 471K-T	B
C2	4510006220	S.ELECTROLYTIC	ECEV1CA101UP	B
C3	4030007130	S.CERAMIC	C1608 CH 1H 101J-T	B

M.=Mounted side (T: Mounted on the Top side, B: Mounted on the Bottom side)

S.=Surface mount

[MAIN UNIT]

REF NO.	ORDER NO.	DESCRIPTION		M.
C4	4030007130	S.CERAMIC	C1608 CH 1H 101J-T	B
C5	4030007050	S.CERAMIC	C1608 CH 1H 220J-T	B
C9	4030007050	S.CERAMIC	C1608 CH 1H 220J-T	B
C10	4030007050	S.CERAMIC	C1608 CH 1H 220J-T	B
C11	4030007050	S.CERAMIC	C1608 CH 1H 220J-T	B
C12	4030006860	S.CERAMIC	C1608 JB 1H 102K-T	B
C13	4030006860	S.CERAMIC	C1608 JB 1H 102K-T	B
C14	4030008920	S.CERAMIC	C1608 JB 1H 473K-T	B
C15	4030006860	S.CERAMIC	C1608 JB 1H 102K-T	B
C16	4030006860	S.CERAMIC	C1608 JB 1H 102K-T	B
C17	4030006860	S.CERAMIC	C1608 JB 1H 102K-T	B
C18	4030006860	S.CERAMIC	C1608 JB 1H 102K-T	B
C19	4030006860	S.CERAMIC	C1608 JB 1H 102K-T	B
C21	4030006860	S.CERAMIC	C1608 JB 1H 102K-T	B
C22	4030006860	S.CERAMIC	C1608 JB 1H 102K-T	B
C23	4030006860	S.CERAMIC	C1608 JB 1H 102K-T	B
C24	4030006860	S.CERAMIC	C1608 JB 1H 102K-T	B
C25	4030006860	S.CERAMIC	C1608 JB 1H 102K-T	B
C26	4030006860	S.CERAMIC	C1608 JB 1H 102K-T	B
C27	4030006860	S.CERAMIC	C1608 JB 1H 102K-T	B
C29	4510004630	S.ELECTROLYTIC	ECEV1CA100SR	B
C30	4030011600	S.CERAMIC	C1608 JB 1E 104K-T	B
C31	4510004630	S.ELECTROLYTIC	ECEV1CA100SR	B
J1	6510023110	CONNECTOR	3008L-8P8C <KIN>	B
DS1	5010000120	S.LED	LN1371G-(TR)	T
DS2	5010000120	S.LED	LN1371G-(TR)	T
DS3	5010000120	S.LED	LN1371G-(TR)	T
DS4	5010000120	S.LED	LN1371G-(TR)	T
DS5	5010000120	S.LED	LN1371G-(TR)	T
DS6	5010000120	S.LED	LN1371G-(TR)	T
DS7	5010000120	S.LED	LN1371G-(TR)	T
DS8	5010000120	S.LED	LN1371G-(TR)	T
DS10	5010000150	S.LED	LT1EP53A	T
DS11	5010000150	S.LED	LT1EP53A	T
MC1	7700002310	MICROPHONE	EM-140	T
S1	2260000980	SWITCH	SKHHL P014A	B
EP1	6910012350	S.BEAD	MMZ1608Y 102BT	B
EP2	6910012350	S.BEAD	MMZ1608Y 102BT	B
EP3	6910012350	S.BEAD	MMZ1608Y 102BT	B
EP4	6910012350	S.BEAD	MMZ1608Y 102BT	B
EP5	0910055172	PCB	B 5811B	B

[MAIN-A BOARD]

REF NO.	ORDER NO.	DESCRIPTION		M.
IC1	1140011490	S.IC	μPD789071MC-041-5A4-E1	B
IC3	1110006310	S.IC	BD5245G-TR	B
IC6	1130012030	S.IC	BR24L02FV-WE2	B
Q1	1530001940	S.TRANSISTOR	2SC2712-BL (TE85R)	B
Q2	1590000680	S.TRANSISTOR	DTC114EUA T106	B
Q3	1590001330	S.TRANSISTOR	DTA114EUA T106	B
Q4	1510000770	S.TRANSISTOR	2SA1586-GR (TE85R)	B
Q5	1510000770	S.TRANSISTOR	2SA1586-GR (TE85R)	B
Q6	1510000770	S.TRANSISTOR	2SA1586-GR (TE85R)	B
Q7	1510000770	S.TRANSISTOR	2SA1586-GR (TE85R)	B
Q8	1530001940	S.TRANSISTOR	2SC2712-BL (TE85R)	B
Q9	1590001010	S.TRANSISTOR	DTB113ZK T146	B
D1	1790000950	S.ZENER	MA8056-M (TX)	B
D3	1750000940	S.DIODE	ISS400 TE61	B
D4	1750000940	S.DIODE	ISS400 TE61	B
D5	1750000940	S.DIODE	ISS400 TE61	B
D6	1750000940	S.DIODE	ISS400 TE61	B
D7	1750000940	S.DIODE	ISS400 TE61	B
D9	1750000940	S.DIODE	ISS400 TE61	B
D10	1750000940	S.DIODE	ISS400 TE61	B
D11	1750000940	S.DIODE	ISS400 TE61	B
D12	1750000940	S.DIODE	ISS400 TE61	B

[MAIN-A UNIT]

REF NO.	ORDER NO.	DESCRIPTION		M.
D16	1730002280	S.ZENER	MA8091-M (TX)	B
D17	1730002280	S.ZENER	MA8091-M (TX)	B
D18	1730002280	S.ZENER	MA8091-M (TX)	B
X1	6060000610	S.CERAMIC	EFOS4914E3	B
L1	6200001520	S.COIL	MLF2012D R82K-T	B
L2	6200001520	S.COIL	MLF2012D R82K-T	B
R2	7030000400	S.RESISTOR	MCR10EZJH 1.5 kΩ	B
R3	7030000400	S.RESISTOR	MCR10EZJH 1.5 kΩ	B
R4	7030000400	S.RESISTOR	MCR10EZJH 1.5 kΩ	B
R5	7030003400	S.RESISTOR	ERJ3GEYJ 471 V (470 Ω)	B
R6	7030003620	S.RESISTOR	ERJ3GEYJ 333 V (33 kΩ)	B
R7	7030003620	S.RESISTOR	ERJ3GEYJ 333 V (33 kΩ)	B
R8	7030003570	S.RESISTOR	ERJ3GEYJ 123 V (12 kΩ)	B
R9	7030003560	S.RESISTOR	ERJ3GEYJ 103 V (10 kΩ)	B
R10	7030003420	S.RESISTOR	ERJ3GEYJ 681 V (680 Ω)	B
R11	7030003420	S.RESISTOR	ERJ3GEYJ 681 V (680 Ω)	B
R12	7030003560	S.RESISTOR	ERJ3GEYJ 103 V (10 kΩ)	B
R13	7030003560	S.RESISTOR	ERJ3GEYJ 103 V (10 kΩ)	B
R14	7030003420	S.RESISTOR	ERJ3GEYJ 681 V (680 Ω)	B
R15	7030003400	S.RESISTOR	ERJ3GEYJ 471 V (470 Ω)	B
R16	7030003560	S.RESISTOR	ERJ3GEYJ 103 V (10 kΩ)	B
R18	7030003560	S.RESISTOR	ERJ3GEYJ 103 V (10 kΩ)	B
R19	7030003640	S.RESISTOR	ERJ3GEYJ 473 V (47 kΩ)	B
R22	7030003520	S.RESISTOR	ERJ3GEYJ 472 V (4.7 kΩ)	B
R23	7030003520	S.RESISTOR	ERJ3GEYJ 472 V (4.7 kΩ)	B
R24	7030003520	S.RESISTOR	ERJ3GEYJ 472 V (4.7 kΩ)	B
R25	7030003520	S.RESISTOR	ERJ3GEYJ 472 V (4.7 kΩ)	B
R27	7030003560	S.RESISTOR	ERJ3GEYJ 103 V (10 kΩ)	B
R35	7030000400	S.RESISTOR	MCR10EZJH 1.5 kΩ	B
R36	7030003560	S.RESISTOR	ERJ3GEYJ 103 V (10 kΩ)	B
R37	7030003460	S.RESISTOR	ERJ3GEYJ 152 V (1.5 kΩ)	B
R38	7030003720	S.RESISTOR	ERJ3GEYJ 224 V (220 kΩ)	B
R39	7030003480	S.RESISTOR	ERJ3GEYJ 222 V (2.2 kΩ)	B
R40	7030003480	S.RESISTOR	ERJ3GEYJ 222 V (2.2 kΩ)	B
R41	7030003560	S.RESISTOR	ERJ3GEYJ 103 V (10 kΩ)	B
R42	7030003860	S.RESISTOR	ERJ3GE JPW V	B
R43	7030003440	S.RESISTOR	ERJ3GEYJ 102 V (1 kΩ)	B
R44	7030003440	S.RESISTOR	ERJ3GEYJ 102 V (1 kΩ)	B
R45	7030003440	S.RESISTOR	ERJ3GEYJ 102 V (1 kΩ)	B
R46	7030003440	S.RESISTOR	ERJ3GEYJ 102 V (1 kΩ)	B
R47	7030003440	S.RESISTOR	ERJ3GEYJ 102 V (1 kΩ)	B
R48	7030003440	S.RESISTOR	ERJ3GEYJ 102 V (1 kΩ)	B
R49	7030003440	S.RESISTOR	ERJ3GEYJ 102 V (1 kΩ)	B
R50	7030003440	S.RESISTOR	ERJ3GEYJ 102 V (1 kΩ)	B
R51	7030003440	S.RESISTOR	ERJ3GEYJ 102 V (1 kΩ)	B
C1	4030006850	S.CERAMIC	C1608 JB 1H 471K-T	B
C2	4510006220	S.ELECTROLYTIC	ECEV1CA101UP	B
C5	4030007050	S.CERAMIC	C1608 CH 1H 220J-T	B
C9	4030007050	S.CERAMIC	C1608 CH 1H 220J-T	B
C10	4030007050	S.CERAMIC	C1608 CH 1H 220J-T	B
C11	4030007050	S.CERAMIC	C1608 CH 1H 220J-T	B
C12	4030006860	S.CERAMIC	C1608 JB 1H 102K-T	B
C13	4030006860	S.CERAMIC	C1608 JB 1H 102K-T	B
C14	4030006900	S.CERAMIC	C1608 JB 1H 103K-T	B
C15	4030006860	S.CERAMIC	C1608 JB 1H 102K-T	B
C16	4030006860	S.CERAMIC	C1608 JB 1H 102K-T	B
C17	4030006860	S.CERAMIC	C1608 JB 1H 102K-T	B
C18	4030006860	S.CERAMIC	C1608 JB 1H 102K-T	B
C19	4030006860	S.CERAMIC	C1608 JB 1H 102K-T	B
C21	4030006860	S.CERAMIC	C1608 JB 1H 102K-T	B
C22	4030006860	S.CERAMIC	C1608 JB 1H 102K-T	B
C23	4030006860	S.CERAMIC	C1608 JB 1H 102K-T	B
C24	4030006860	S.CERAMIC	C1608 JB 1H 102K-T	B
C25	4030006860	S.CERAMIC	C1608 JB 1H 102K-T	B
C26	4030006860	S.CERAMIC	C1608 JB 1H 102K-T	B
C27	4030006860	S.CERAMIC	C1608 JB 1H 102K-T	B
C29	4510004630	S.ELECTROLYTIC	ECEV1CA100SR	B
C30	4030011600	S.CERAMIC	C1608 JB 1E 104K-T	B
C31	4510004630	S.ELECTROLYTIC	ECEV1CA100SR	B
J1	6510023110	CONNECTOR	3008L-8P8C <KIN>	B
DS1	5010000120	S.LED	LN1371G-(TR)	T
DS2	5010000120	S.LED	LN1371G-(TR)	T
DS3	5010000120	S.LED	LN1371G-(TR)	T
DS4	5010000120	S.LED	LN1371G-(TR)	T
DS5	5010000120	S.LED	LN1371G-(TR)	T
DS6	5010000120	S.LED	LN1371G-(TR)	T

M.=Mounted side (T: Mounted on the Top side, B: Mounted on the Bottom side)

S.=Surface mount

[MAIN-A UNIT]

REF NO.	ORDER NO.	DESCRIPTION		M.
DS7	5010000120	S.LED	LN1371G-(TR)	T
DS8	5010000120	S.LED	LN1371G-(TR)	T
DS10	5010000150	S.LED	LT1EP53A	T
DS11	5010000150	S.LED	LT1EP53A	T
MC1	7700002310	MICROPHONE	EM-140	T
S1	2260000980	SWITCH	SKHHLP014A	B
EP1	6910012350	S.BEAD	MMZ1608Y 102BT	B
EP2	6910012350	S.BEAD	MMZ1608Y 102BT	B
EP3	6910012350	S.BEAD	MMZ1608Y 102BT	B
EP4	6910012350	S.BEAD	MMZ1608Y 102BT	B
EP5	0910057281	PCB	B 6094A	B

6-3 UT-108 (OPTIONAL UNIT)

REF NO.	ORDER NO.	DESCRIPTION		M.
IC1	1130007560	S.IC	LC73881M-TLM	B
IC2	1130007300	S.IC	TC4W66FU (TE12L)	B
X1	6050005090	XTAL	CR-245 (4.194304 MHz)	T
L1	6200001260	S.COIL	MLF2012A 1R8M-T	B
R1	7030003440	S.RESISTOR	ERJ3GEYJ 102 V (1 kΩ)	B
R2	7030003440	S.RESISTOR	ERJ3GEYJ 102 V (1 kΩ)	B
R3	7030003680	S.RESISTOR	ERJ3GEYJ 104 V (100 kΩ)	B
R4	7030003440	S.RESISTOR	ERJ3GEYJ 102 V (1 kΩ)	B
R5	7030003440	S.RESISTOR	ERJ3GEYJ 102 V (1 kΩ)	B
R6	7030003440	S.RESISTOR	ERJ3GEYJ 102 V (1 kΩ)	B
R7	7030003680	S.RESISTOR	ERJ3GEYJ 104 V (100 kΩ)	B
R8	7030003680	S.RESISTOR	ERJ3GEYJ 104 V (100 kΩ)	B
R9	7030003580	S.RESISTOR	ERJ3GEYJ 153 V (15 kΩ)	B
R10	7030003510	S.RESISTOR	ERJ3GEYJ 392 V (3.9 kΩ)	B
C1	4550006300	S.TANTALUM	ECST1AY475R	B
C2	4030006860	S.CERAMIC	C1608 JB 1H 102K-T	B
C3	4030007090	S.CERAMIC	C1608 CH 1H 470J-T	B
C4	4030011600	S.CERAMIC	C1608 JB 1E 104K-T	B
C5	4030011600	S.CERAMIC	C1608 JB 1E 104K-T	B
C6	4030011600	S.CERAMIC	C1608 JB 1E 104K-T	B
C7	4030011600	S.CERAMIC	C1608 JB 1E 104K-T	B
J1	6510018440	S.CONNECTOR	AXN430C330P	B
EP1	0910050481	PCB	B 5191A	B

M.=Mounted side (T: Mounted on the Top side, B: Mounted on the Bottom side)

S.=Surface mount

6-4 UT-115 (OPTIONAL UNIT)

[MAIN UNIT]

REF NO.	ORDER NO.		DESCRIPTION	M.
IC1	1180002390	S.REG	S-812C33AMC-C2N-T2	T
IC2	1180002370	S.REG	R1111N321B-TR	T
IC50	1130011630	S.IC	AD73311ARS	T
IC101	1130008360	S.IC	TC7SHU04FU (TE85L)	B
IC103	1130006890	S.IC	TC7S04FU (TE85R)	T
IC151	1130010920	S.IC	AMBE-2020	T
IC202	1130010460	S.IC	TC7SH08FU (TE85L)	B
IC203	1110005730	S.IC	S-80928CNMC-G8Y-T2	B
IC204	1140010770	S.IC	HD64F3687FP	B
IC251	1110005290	S.IC	NJM2115V-TE1	B
IC252	1110005430	S.IC	CMX589AD5	B
IC253	1110006200	S.IC	NJM13404V-TE1	B
IC254	1130004200	S.IC	TC4S66F (TE85R)	B
IC351	1120002980	S.IC	MAX3226EAE-T	T
Q50	1510000770	S.TRANSISTOR	2SA1586-GR (TE85R)	T
Q51	1590000430	S.TRANSISTOR	DTC144EUA T106	B
Q201	1590000430	S.TRANSISTOR	DTC144EUA T106	B
Q202	1590000430	S.TRANSISTOR	DTC144EUA T106	B
Q251	1590000430	S.TRANSISTOR	DTC144EUA T106	B
Q252	1590000430	S.TRANSISTOR	DTC144EUA T106	B
Q301	1590000430	S.TRANSISTOR	DTC144EUA T106	B
Q302	1590000430	S.TRANSISTOR	DTC144EUA T106	B
Q303	1590000430	S.TRANSISTOR	DTC144EUA T106	B
Q305	1590001660	S.TRANSISTOR	XP4312 (TX)	B
Q306	1590001660	S.TRANSISTOR	XP4312 (TX)	B
Q400	1510000770	S.TRANSISTOR	2SA1586-GR (TE85R)	B
Q401	1590000430	S.TRANSISTOR	DTC144EUA T106	B
D151	1790001240	S.DIODE	MA2S728-(TX)	T
D152	1790001250	S.DIODE	MA2S111-(TX)	B
X101	6050011240	S.XTAL	CR-708 (16.384 MHz)	T
X201	6050011700	S.XTAL	CR-760 (9.8304 MHz)	T
L50	6200003960	S.COIL	MLF1608A 1R0K-T	T
L151	6200003960	S.COIL	MLF1608A 1R0K-T	B
L201	6200003960	S.COIL	MLF1608A 1R0K-T	B
L351	6200003960	S.COIL	MLF1608A 1R0K-T	T
R1	7030005240	S.RESISTOR	ERJ2GEJ 473 X (47 kΩ)	T
R2	7030000180	S.RESISTOR	MCR10EZHJ 22 Ω (220)	T
R50	7030000510	S.RESISTOR	ERJ2GEJ 681 X (680 Ω)	T
R51	7030005120	S.RESISTOR	ERJ2GEJ 102 X (1 kΩ)	T
R52	7030004980	S.RESISTOR	ERJ2GEJ 101 X (100 Ω)	B
R53	7030005240	S.RESISTOR	ERJ2GEJ 473 X (47 kΩ)	T
R54	7030005240	S.RESISTOR	ERJ2GEJ 473 X (47 kΩ)	T
R55	7030005090	S.RESISTOR	ERJ2GEJ 104 X (100 kΩ)	B
R56	7030004980	S.RESISTOR	ERJ2GEJ 101 X (100 Ω)	B
R57	7030005240	S.RESISTOR	ERJ2GEJ 473 X (47 kΩ)	T
R58	7030010040	S.RESISTOR	ERJ2GE-JPW	B
R59	7030005090	S.RESISTOR	ERJ2GEJ 104 X (100 kΩ)	T
R60	7030005050	S.RESISTOR	ERJ2GEJ 103 X (10 kΩ)	T
R100	7030010040	S.RESISTOR	ERJ2GE-JPW	T
R101	7030005160	S.RESISTOR	ERJ2GEJ 105 X (1 MΩ)	B
R102	7030004980	S.RESISTOR	ERJ2GEJ 101 X (100 Ω)	B
R103	7030005120	S.RESISTOR	ERJ2GEJ 102 X (1 kΩ)	T
R151	7030005120	S.RESISTOR	ERJ2GEJ 102 X (1 kΩ)	T
R152	7030005240	S.RESISTOR	ERJ2GEJ 473 X (47 kΩ)	T
R201	7030005120	S.RESISTOR	ERJ2GEJ 102 X (1 kΩ)	B
R202	7030005120	S.RESISTOR	ERJ2GEJ 102 X (1 kΩ)	B
R203	7030005040	S.RESISTOR	ERJ2GEJ 472 X (4.7 kΩ)	B
R204	7030005040	S.RESISTOR	ERJ2GEJ 472 X (4.7 kΩ)	B
R205	7030005040	S.RESISTOR	ERJ2GEJ 472 X (4.7 kΩ)	B
R206	7030005120	S.RESISTOR	ERJ2GEJ 102 X (1 kΩ)	B
R209	7030005120	S.RESISTOR	ERJ2GEJ 102 X (1 kΩ)	B
R211	7030005240	S.RESISTOR	ERJ2GEJ 473 X (47 kΩ)	B
R212	7030005240	S.RESISTOR	ERJ2GEJ 473 X (47 kΩ)	B
R216	7030005240	S.RESISTOR	ERJ2GEJ 473 X (47 kΩ)	B
R217	7030005240	S.RESISTOR	ERJ2GEJ 473 X (47 kΩ)	B
R218	7030005240	S.RESISTOR	ERJ2GEJ 473 X (47 kΩ)	B
R219	7030005240	S.RESISTOR	ERJ2GEJ 473 X (47 kΩ)	B
R221	7030010040	S.RESISTOR	ERJ2GE-JPW	B
R251	7030005240	S.RESISTOR	ERJ2GEJ 473 X (47 kΩ)	B
R252	7030005090	S.RESISTOR	ERJ2GEJ 104 X (100 kΩ)	B
R253	7030005240	S.RESISTOR	ERJ2GEJ 473 X (47 kΩ)	B
R254	7030005240	S.RESISTOR	ERJ2GEJ 473 X (47 kΩ)	B
R255	7030005240	S.RESISTOR	ERJ2GEJ 473 X (47 kΩ)	B
R256	7030005090	S.RESISTOR	ERJ2GEJ 104 X (100 kΩ)	B
R257	7030005240	S.RESISTOR	ERJ2GEJ 473 X (47 kΩ)	B
R258	7030005090	S.RESISTOR	ERJ2GEJ 104 X (100 kΩ)	B

M.=Mounted side (T: Mounted on the Top side, B: Mounted on the Bottom side)

[MAIN UNIT]

REF NO.	ORDER NO.		DESCRIPTION	M.
R260	7030005090	S.RESISTOR	ERJ2GEJ 104 X (100 kΩ)	B
R261	7030005240	S.RESISTOR	ERJ2GEJ 473 X (47 kΩ)	B
R262	7030005220	S.RESISTOR	ERJ2GEJ 223 X (22 kΩ)	T
R264	7310004610	S.TRIMMER	EVM-2WSX80 B15 (104)	T
R267	7030005090	S.RESISTOR	ERJ2GEJ 104 X (100 kΩ)	B
R268	7030006610	S.RESISTOR	ERJ2GEJ 394 X (390 kΩ)	B
R269	7030005060	S.RESISTOR	ERJ2GEJ 333 X (33 kΩ)	B
R270	7030005240	S.RESISTOR	ERJ2GEJ 473 X (47 kΩ)	B
R308	7030004980	S.RESISTOR	ERJ2GEJ 101 X (100 Ω)	T
R309	7030004980	S.RESISTOR	ERJ2GEJ 101 X (100 Ω)	T
R315	7030004980	S.RESISTOR	ERJ2GEJ 101 X (100 Ω)	T
R316	7030004980	S.RESISTOR	ERJ2GEJ 101 X (100 Ω)	T
R317	7030004980	S.RESISTOR	ERJ2GEJ 101 X (100 Ω)	B
R318	7030004980	S.RESISTOR	ERJ2GEJ 101 X (100 Ω)	T
R400	7030005090	S.RESISTOR	ERJ2GEJ 104 X (100 kΩ)	B
R401	7030009290	S.RESISTOR	ERJ2GEJ 562 X (5.6 kΩ)	B
C1	4550006250	S.TANTALUM	TEESVA 1A 106M8L	T
C2	4550006250	S.TANTALUM	TEESVA 1A 106M8L	T
C5	4030017460	S.CERAMIC	ECJ0EB1E102K	B
C7	4550005980	S.TANTALUM	TEESVA 1A 475M8L	T
C8	4030016930	S.CERAMIC	ECJ0EB1A104K	T
C9	4550006250	S.TANTALUM	TEESVA 1A 106M8L	T
C10	4030016930	S.CERAMIC	ECJ0EB1A104K	T
C11	4550006480	S.TANTALUM	TEESVA 1C 475M8L	T
C50	4030016930	S.CERAMIC	ECJ0EB1A104K	T
C51	4030016970	S.CERAMIC	ECJ0EB1C223K	T
C53	4030016930	S.CERAMIC	ECJ0EB1A104K	T
C54	4550006250	S.TANTALUM	TEESVA 1A 106M8L	T
C55	4030016930	S.CERAMIC	ECJ0EB1A104K	T
C56	4030016950	S.CERAMIC	ECJ0EB1A473K	B
C57	4030016930	S.CERAMIC	ECJ0EB1A104K	T
C58	4030016930	S.CERAMIC	ECJ0EB1A104K	T
C102	4540000070	S.TRIMMER	TZY2Z100A001	T
C103	4030017590	S.CERAMIC	ECJ0EC1H070C	T
C104	4030016930	S.CERAMIC	ECJ0EB1A104K	B
C106	4030016930	S.CERAMIC	ECJ0EB1A104K	T
C150	4550000460	S.TANTALUM	TEESVA 1C 105M8L	T
C151	4030016930	S.CERAMIC	ECJ0EB1A104K	T
C152	4030016930	S.CERAMIC	ECJ0EB1A104K	T
C153	4030016930	S.CERAMIC	ECJ0EB1A104K	T
C154	4030016930	S.CERAMIC	ECJ0EB1A104K	T
C155	4030016930	S.CERAMIC	ECJ0EB1A104K	T
C156	4030016930	S.CERAMIC	ECJ0EB1A104K	T
C157	4030016930	S.CERAMIC	ECJ0EB1A104K	T
C159	4030016930	S.CERAMIC	ECJ0EB1A104K	B
C201	4030016930	S.CERAMIC	ECJ0EB1A104K	T
C202	4030017590	S.CERAMIC	ECJ0EC1H070C	B
C203	4030016930	S.CERAMIC	ECJ0EB1A104K	B
C204	4030017390	S.CERAMIC	ECJ0EC1H180J	B
C205	4030016930	S.CERAMIC	ECJ0EB1A104K	B
C206	4030016790	S.CERAMIC	ECJ0EB1C103K	B
C207	4540000080	S.TRIMMER	TZY2R200A001	T
C250	4030016930	S.CERAMIC	ECJ0EB1A104K	B
C252	4030017490	S.CERAMIC	C1608 JB 1A 105K-T	B
C253	4030017400	S.CERAMIC	ECJ0EC1H220J	B
C255	4030017490	S.CERAMIC	C1608 JB 1A 105K-T	B
C256	4030016930	S.CERAMIC	ECJ0EB1A104K	B
C257	4030017030	S.CERAMIC	ECJ0EB1A273K	B
C258	4030017030	S.CERAMIC	ECJ0EB1A273K	B
C259	4030017760	S.CERAMIC	ECJ0EB1H222K	T
C260	4030017490	S.CERAMIC	C1608 JB 1A 105K-T	B
C261	4030016930	S.CERAMIC	ECJ0EB1A104K	B
C262	4030017490	S.CERAMIC	C1608 JB 1A 105K-T	B
C263	4030016930	S.CERAMIC	ECJ0EB1A104K	B
C333	4030017460	S.CERAMIC	ECJ0EB1E102K	T
C351	4030011810	S.CERAMIC	C1608 JB 1A 224K-T	T
C352	4030011810	S.CERAMIC	C1608 JB 1A 224K-T	T
C353	4030011810	S.CERAMIC	C1608 JB 1A 224K-T	T
C354	4030011810	S.CERAMIC	C1608 JB 1A 224K-T	T
C355	4030011600	S.CERAMIC	C1608 JB 1E 104K-T	T
C401	4550006250	S.TANTALUM	TEESVA 1A 106M8L	B
J301	6510018440	S.CONNECTOR	AXN430C330P	B
EP1	0910057812	PCB	B 6071B	

S.=Surface mount

SECTION 7 MECHANICAL PARTS AND DISSASSEMBLY

7-1 IC-2200H

[CHASSIS PARTS]

REF. NO.	ORDER NO.	DESCRIPTION	QTY.
J1	6510004880	Connector MR-DS-E 01	1
SP1	2510001030	Speaker VS-57-0837A	1
MP1	8010019380	2698 chassis	1
MP2	8110008040	2698 cover	1
MP3	8930045600	2088 SP rubber	1
MP4	8930062130	Thermally sheet (AP)	1
MP6	8810008660	Screw PH BT M3 × 8 NI-ZU	12
MP7	8810009610	Screw FH M2.6 × 6 ZK	4
MP8	8810005160	Cap bolt M3 × 20 ZK	2

[LOGIC UNIT]

REF. NO.	ORDER NO.	DESCRIPTION	QTY.
J1	6450002210	Connector 3017-8821	1
R61	7210001870	Variable resistor EVU-F2AF20 A14	1
R62	7210001860	Variable resistor EVU-F2AF20 B14	1
S9	2250000460	Switch EVQ-VENF0224B	1
DS1	5030002660	LCD IS08264E00V2	1
EP11	8930062251	LCD contact SRCN-2698-SP-N-W-1	1
MP1	8210020350	2698 front panel	1
MP2	8210020340	2698 reflector	1
MP3	8930061130	2698 2-button	1
MP4	8930061140	2698 7-button	1
MP5	8930045610	2088 LCD filter	1
MP6	8810008990	Screw PH BT M2 × 10 ZK	4
MP7	8510015700	2698 front plate	1
MP8	8610011620	Knob N316	1
MP9	8610011610	Knob N317	2
MP11	8930062710	Sponge (HR)	1
MP12	8930062700	Himelon sheet (CM)	1

[MAIN UNIT]

REF. NO.	ORDER NO.	DESCRIPTION	QTY.
J4	6450002220	Connector PJ-0008P-5	1
J7	6450001430	Connector HSJ1462-01-010	1
W6	8900010980	DC power cable OPC-1131	1
MP1	8510014470	2509 VCO case	1
MP2	8510014460	2509 VCO cover	1
MP3	8930005320	Filter spacer	2
MP4	8930062610	2698 M-holder	1

Screw abbreviations BT, A: Self-tapping
 PH: Pan head FH: Flat head
 ZK: Black BS: Brass
 NI: Nickel NI-ZU: Nickel-Zinc

[ACCESSORIES]

REF. NO.	ORDER NO.	DESCRIPTION	QTY.
F1	5210000080	Fuse FGB 20A	1
W1	8900010990	DC power cable OPC-1132	1
MC1	0880001490	Microphone HM-133V	1
MP1	8010019260	2633 mobile bracket	1
MP2	8820000530	Flange bolt M4 × 8 NI	4
MP3	8810000470	Screw PH M5 × 12 (+-)	4
MP4	8810000950	Screw PH A M5 × 12	4
MP5	8850000150	Flat washer M5 NI BS	4
MP6	8850000390	Spring washer M5	4
MP7	8830000120	Nut M5	4
MP8	8930007300	Mic hanger [USA] only	1
MP9	8930062650	Insulation sheet (HS)	1

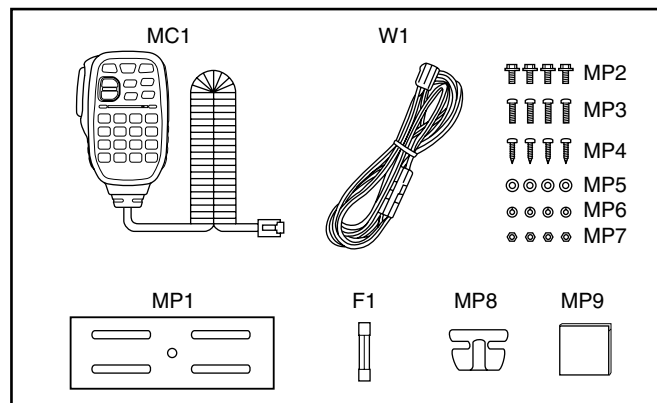

7-2 HM-133V

[CHASSIS PARTS]

REF. NO.	ORDER NO.	DESCRIPTION	QTY.
W1	8900011270	Cable OPC-1153	1
MP1	8210018830	2539 front panel [HM-133]	1
	8210018890	2539 front panel (A) [HM-133S]	1
	8210018910	2539 front panel (B) [HM-133V]	1
MP2	8210018840	2539 rear panel	1
MP3	8930057380	2539 PTT button	1
MP4	8930057390	2539 LED lens	2
MP5	8930057570	2539 SW rubber	1
MP6	8930057520	2539 keyboard [HM-133]	1
	8930057710	2539 keyboard (A) [HM-133S]	1
	8930057700	2539 keyboard (B) [HM-133V]	1
MP8	8810009370	Screw PH BT M3 × 12 ZK	2
MP9	8810009560	Screw PH BT M2 × 6 ZK	3

[MAIN/MAIN-A UNIT]

REF. NO.	ORDER NO.	DESCRIPTION	QTY.
J1	6510023110	Connector 3008L-8P8C	1
S1	2260000980	Switch SKHHL014A	1
MC1	7700002310	Microphone EM-140	1

HM-133V

Unit abbreviations
 (C): CHASSIS PARTS
 (M): MAIN/MAIN-A UNIT

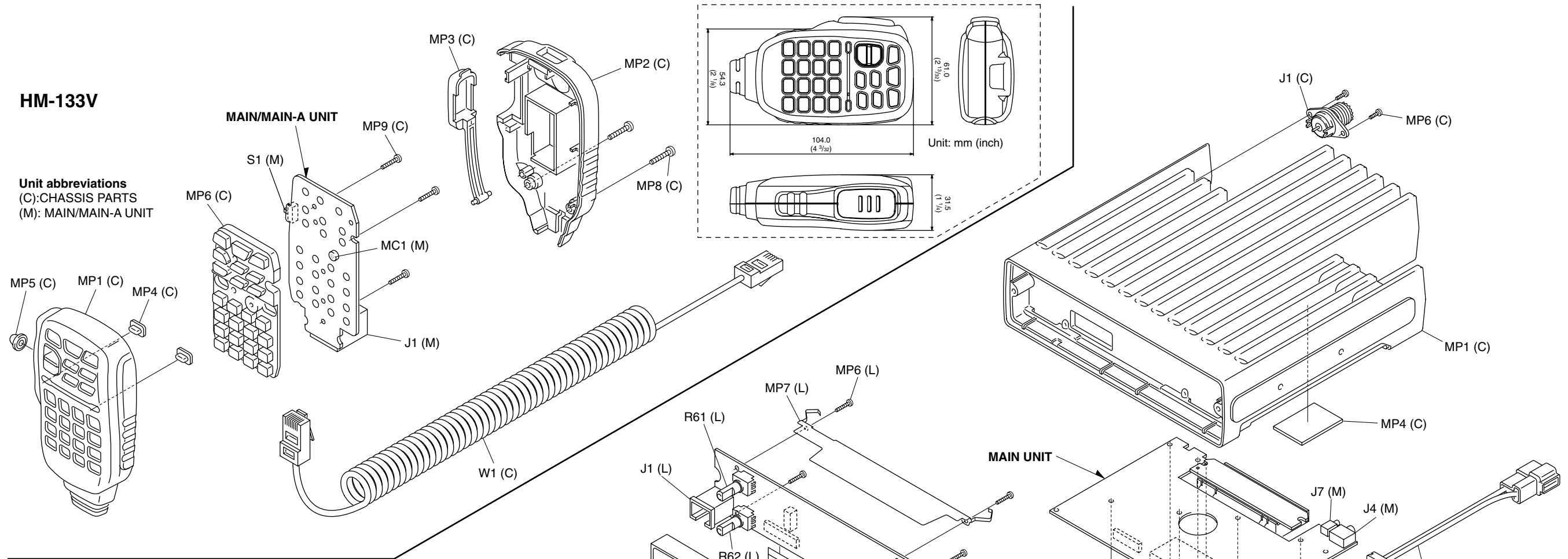

IC-2200H

Unit abbreviations
 (C): CHASSIS PARTS
 (L): LOGIC UNIT
 (M): MAIN UNIT

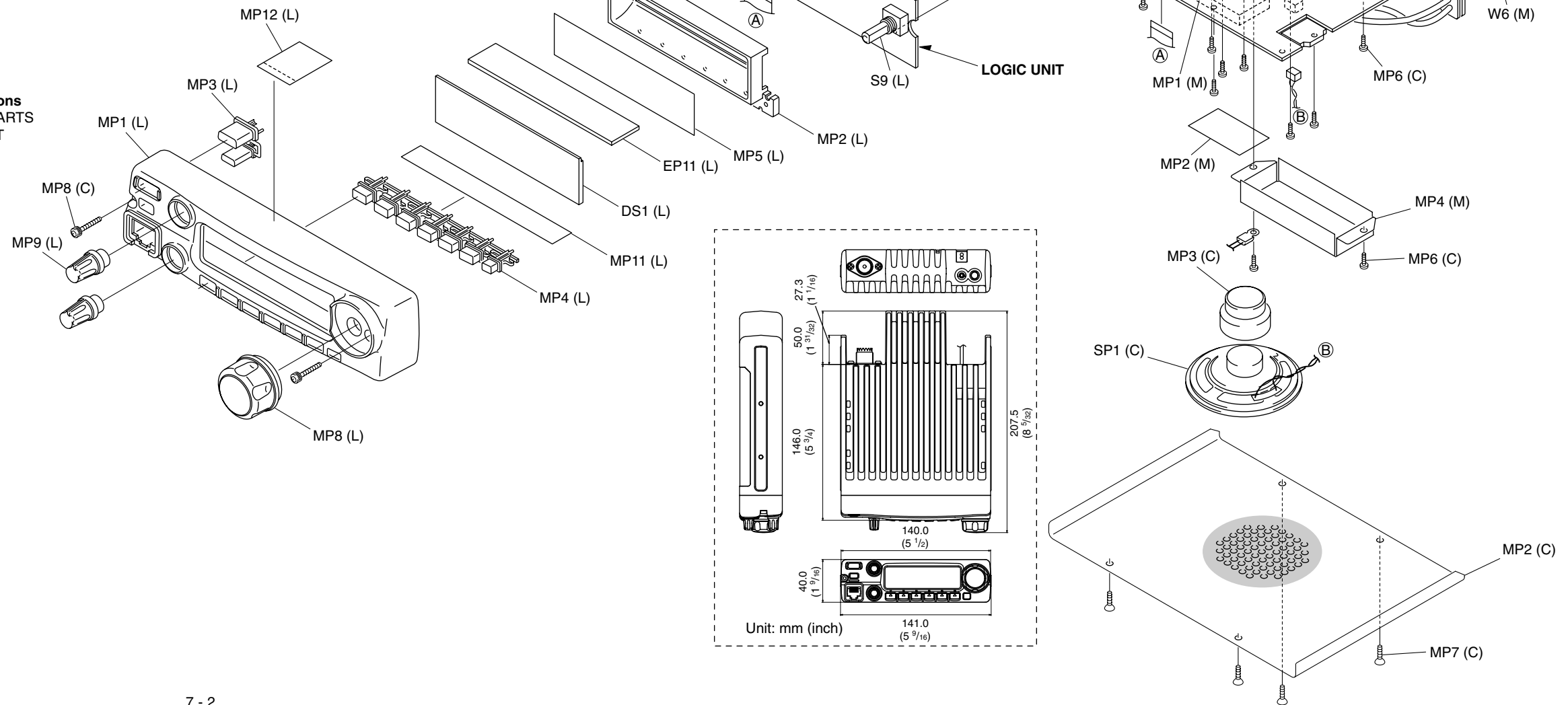

SECTION 8 SEMI-CONDUCTOR INFORMATION

• TRANSISTORS AND FET'S

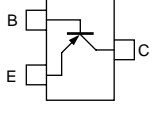
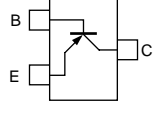
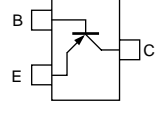
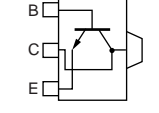
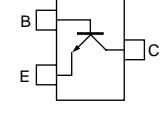
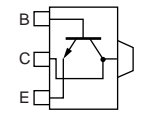
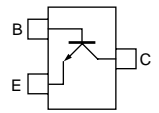
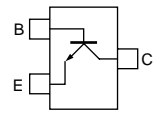
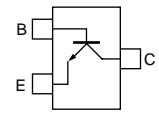
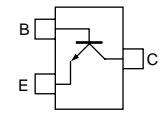
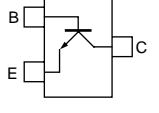
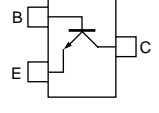
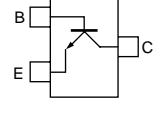
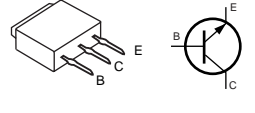
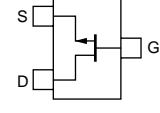
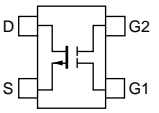
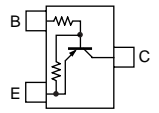
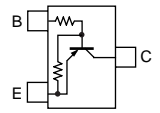
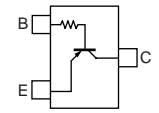
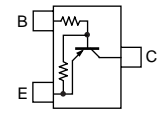
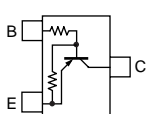
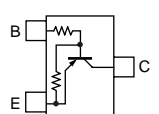
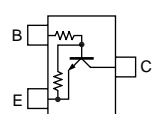
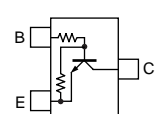
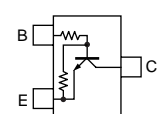
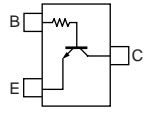
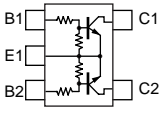
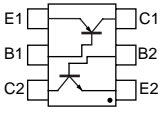
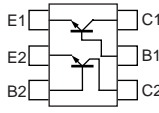
2SA1362 Y (Symbol: AEY) 	2SA1576A T106 R (Symbol: FR) 	2SA1586 GR (Symbol: SG) 	2SB798 T2 DK (Symbol: DK) 	2SC2712 BL (Symbol: BL) 
2SC2954 T1 (Symbol: QK) 	2SC3356 (Symbol: R25) 	2SC4116 BL (Symbol: LL) 	2SC4116 GR (Symbol: LG) 	2SC4213 B (Symbol: AB) 
2SC4226 T1 R25 (Symbol: R25) 	2SC4406 (Symbol: JT) 	2SC4617 TLS (Symbol: BS) 	2SC4684 (Symbol: C4684) 	2SK1069 4 TL (Symbol: FJ) 
3SK299 T1 U73 (Symbol: U73) 	DTA113 ZU T106 (Symbol: 111) 	DTA114EUA T106 (Symbol: 14) 	DTA143TUA (Symbol: 93) 	DTA144 EE TL (Symbol: 16) 
DTA144EUA T106 (Symbol: 16) 	DTB113ZK (Symbol: G11) 	DTC114EUA T106 (Symbol: 24) 	DTC143ZUA (Symbol: E23) 	DTC144EUA T106 (Symbol: 26_) 
DTC144TU T106 (Symbol: 06) 	UMG2N (Symbol: G2) 	XP4601 (Symbol: 5C) 	XP6501 AB (Symbol: 5N) 	

• DIODES

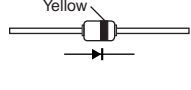
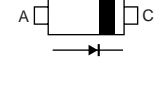
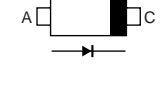
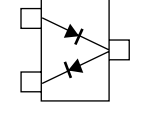
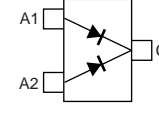
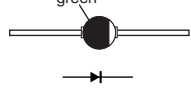
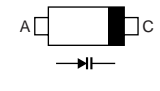
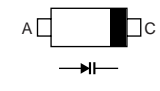
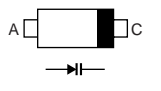
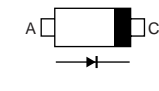
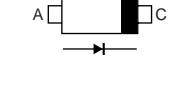
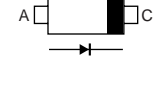
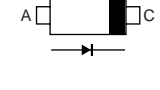
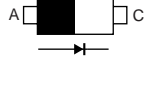
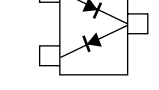
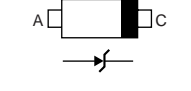
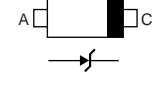
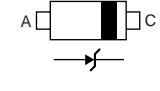
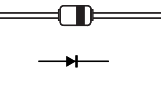
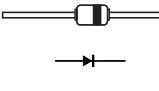
1SS133 	1SS355 (Symbol: A) 	1SS400 (Symbol: A) 	DA221 TL (Symbol: K) 	DAN222TL (Symbol: N) 
DSA3A1 (Color: Green) 	HVC350B (Symbol: B0) 	HVC375B (Symbol: B8) 	HVC376B (Symbol: B9) 	HVU131TRF (Symbol: P1) 
MA2S077 (Symbol: S) 	MA2S111 (Symbol: A) 	MA2S30400 L (Symbol: K) 	MA77 (Symbol: 4B) 	MA742 (Symbol: M1U) 
MA8056 M (Symbol: 5-6) 	MA8091 M (Symbol: 9-1) 	RD20E B2 (Symbol: 20 B2) 	XB15A308 (Symbol: T8) 	XB15A407 

SECTION 9 BOARD LAYOUTS

9-1 LOGIC UNIT • TOP VIEW

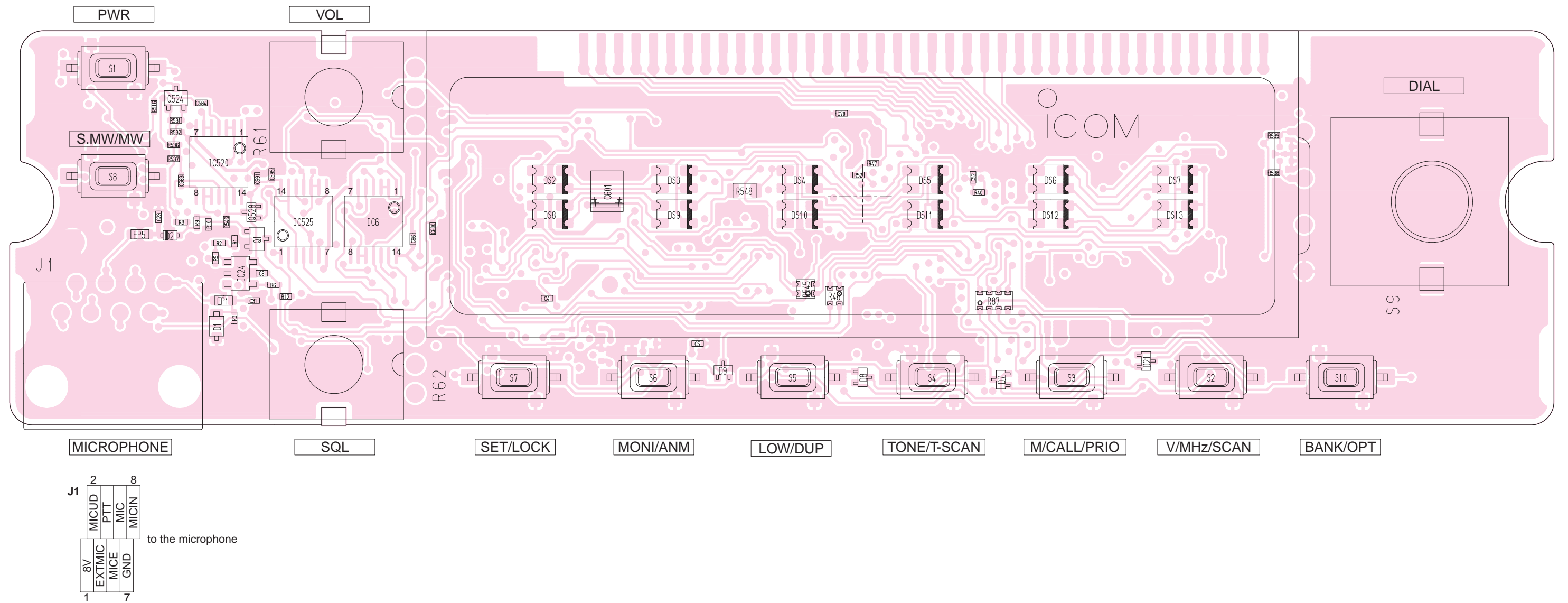

• BOTTOM VIEW (LOGIC UNIT)

J4															
15	OPV1	OPV2	OPV3	GND	OPT3	OPT2	OPT1	SIG_OUT	NC	BUSY	NC	MIC_IN	MIC_OUT	PTTO	1
16	OPV1	SI	OPSO	NC	CCS	REFMOD	AFOUT	DETO	RX_MUTE	232RX	232TX	NC	+8V	+5V	30

to the optional unit

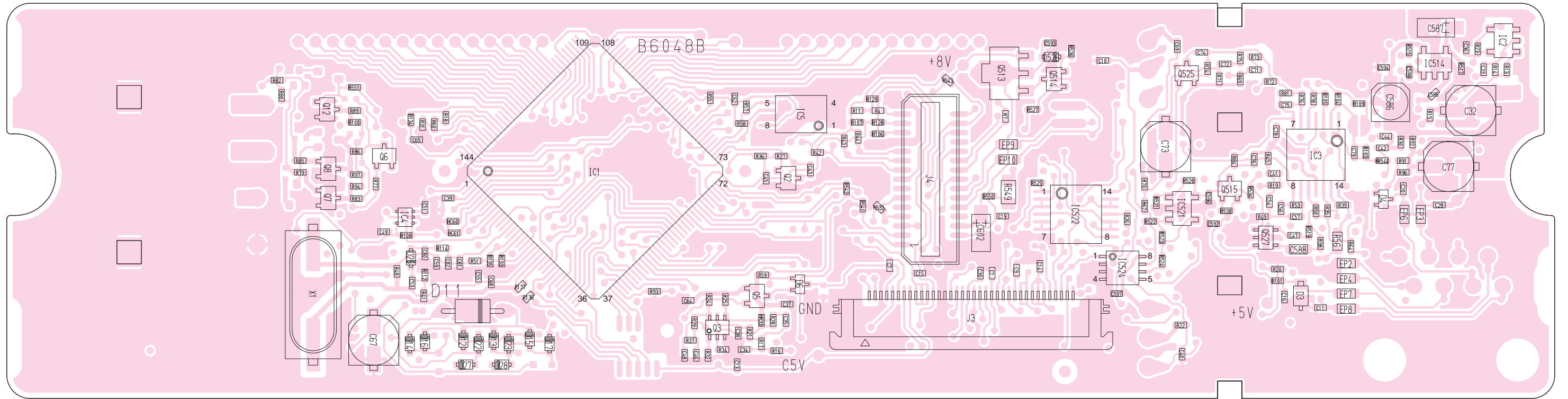

J3	
1	232TX
	232RX
	GND
	CLONE
	POWON
	LVIN
	VOLOUT
	C5V
	+8V
	+8V
	+8V
	+8V
	EXSTB
	GND
	GND
	SO
	PLCLK
	PLLSTB
	OE
	BSHIFT
	DIGLW
	REF_V
	UNLK
	MODIN
	TEMP
	SCK
	OPV1
	MICGND
	MICGND
	+5V
	+5V
	+5V
	IDET
	DETO
	CTCSS
	SD
36	NOIS

to the MAIN unit J11

9-2 MAIN UNIT
• TOP VIEW

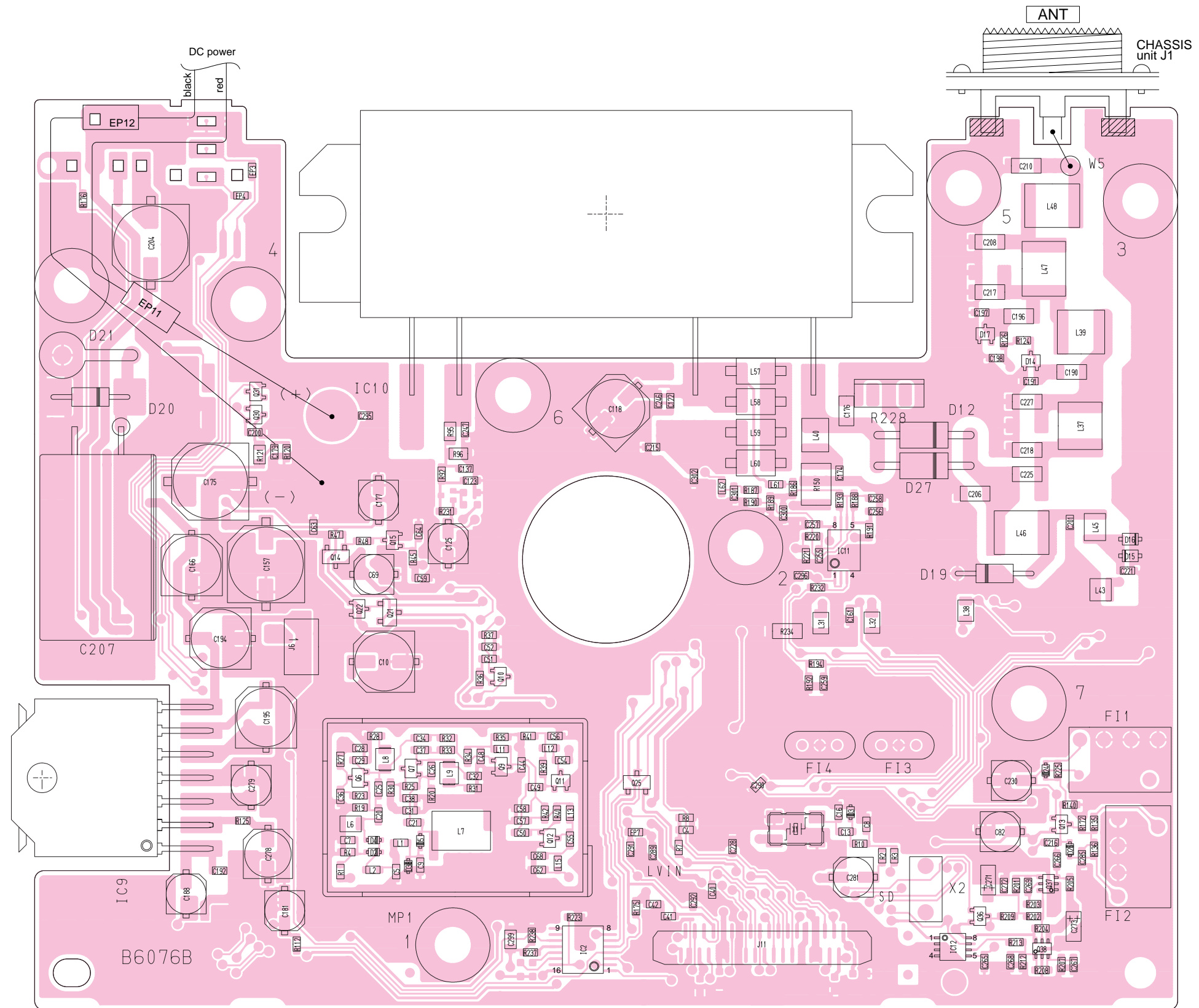

35	232RX	232TX	36
CLONE	GND	PWRON	GND
LVIN	VOLOUT	+8V	+8V
C5V	+8V	GND	GND
+8V	GND	SO	PLLSTB
EXSTB	GND	BSSHIFT	REF_V
PLCLK	OE	MODIN	SCK
DEGLW	UNLK	TEMP	GND
OPV1	GND	+5V	+5V
IDET	+5V	DETO	SD
CTCSS	NOIS		
1			2

to the LOGIC unit J3

• BOTTOM VIEW (MAIN UNIT)

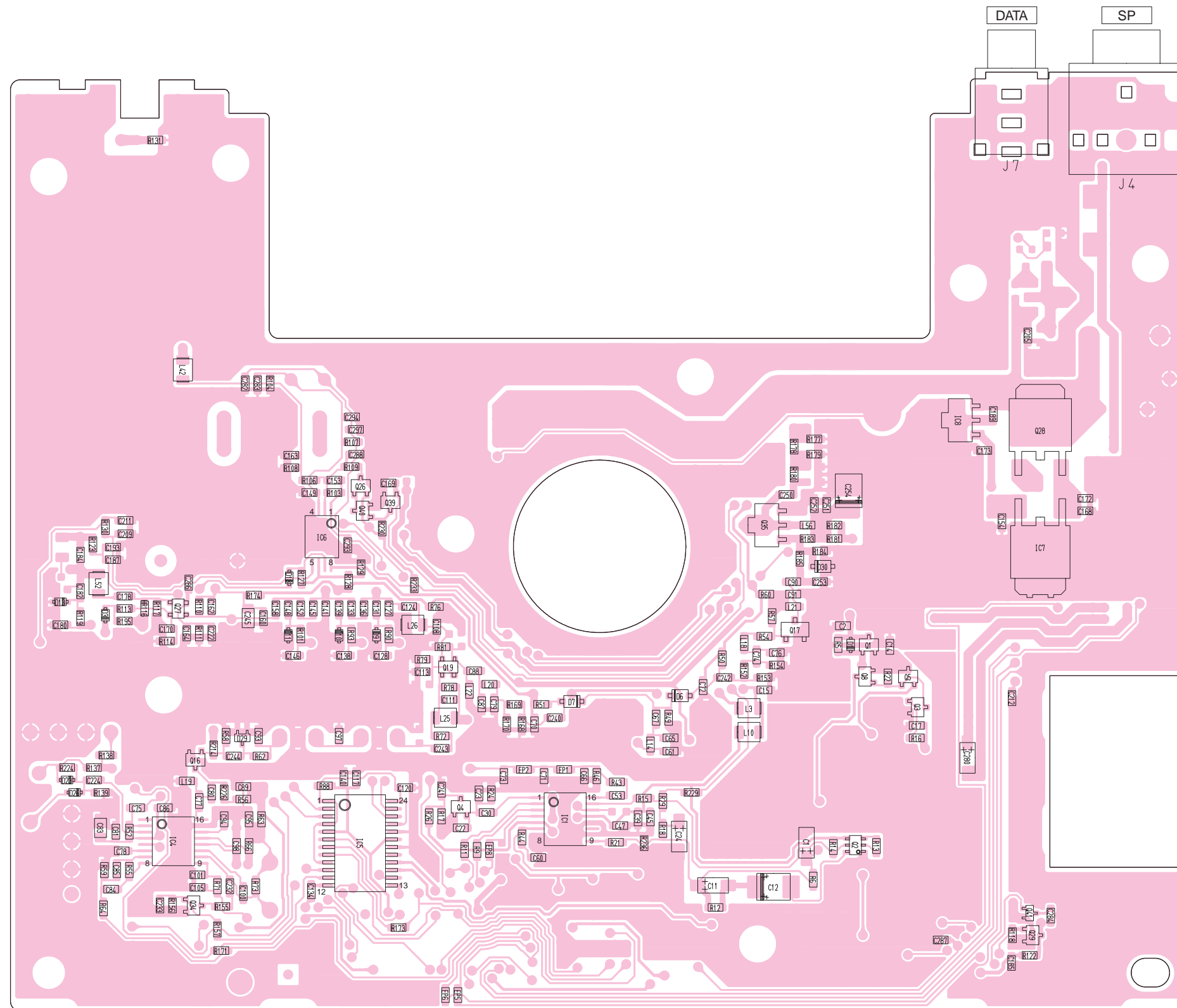

9-3 HM-133V
• TOP VIEW (MAIN UNIT)

NOTE:
 HM-133V's main unit has 2 versions (MAIN or MAIN-A).
 MAIN unit employs old type CPU, MAIN-A unit employs new type one.
 Make sure to be used whether MAIN unit or MAIN-A unit before servicing.

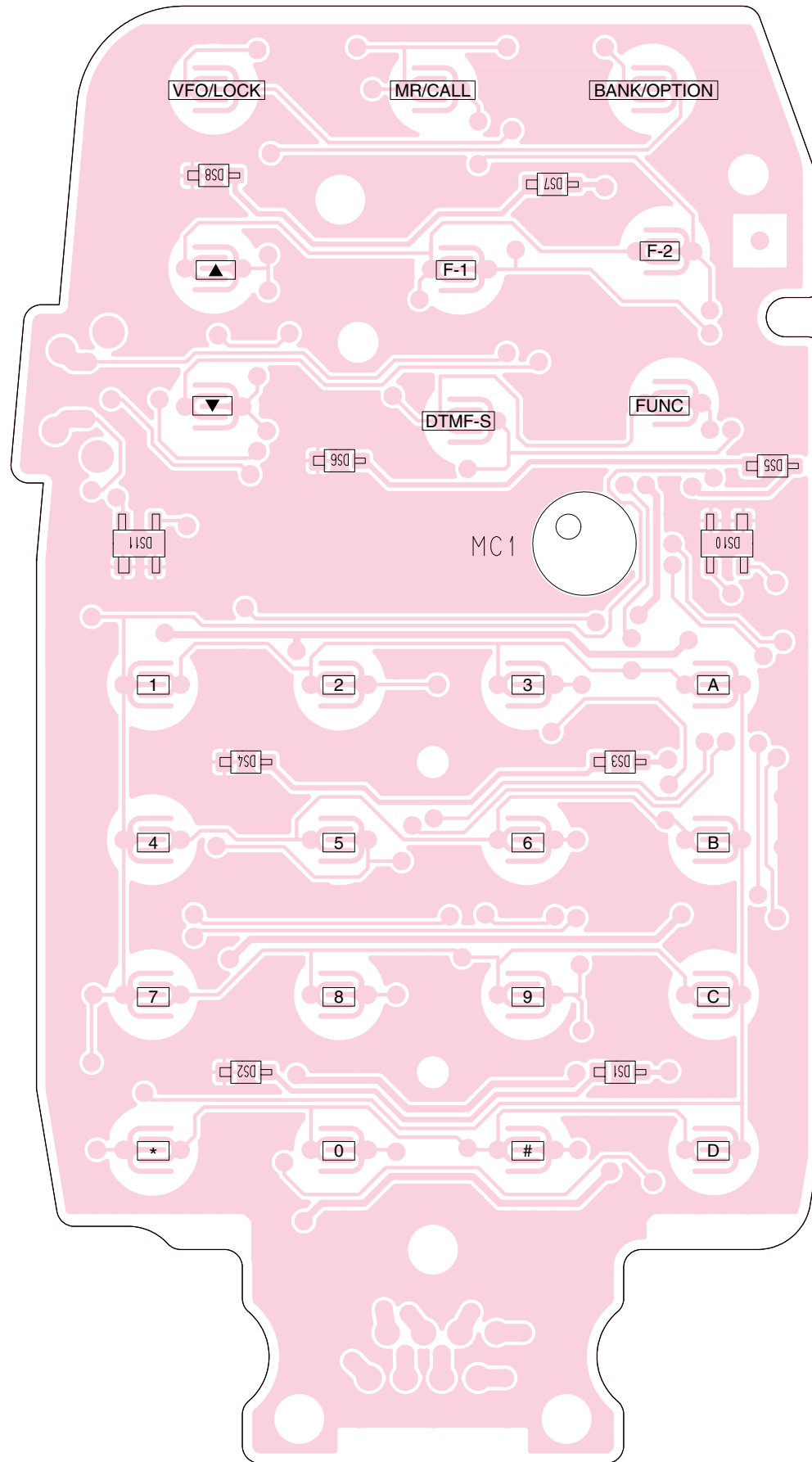

• TOP VIEW (MAIN-A UNIT)

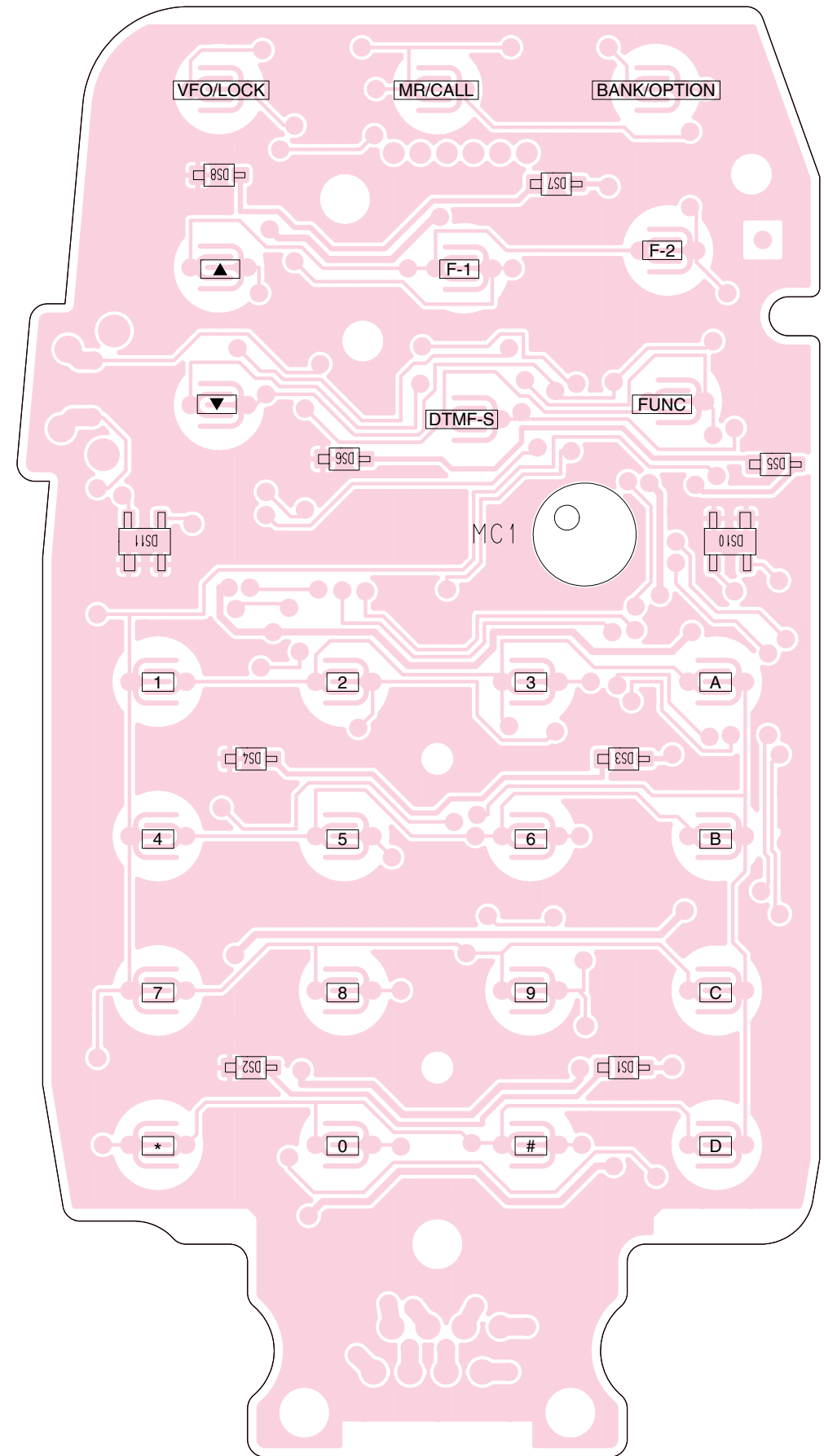

• BOTTOM VIEW (MAIN-A UNIT)

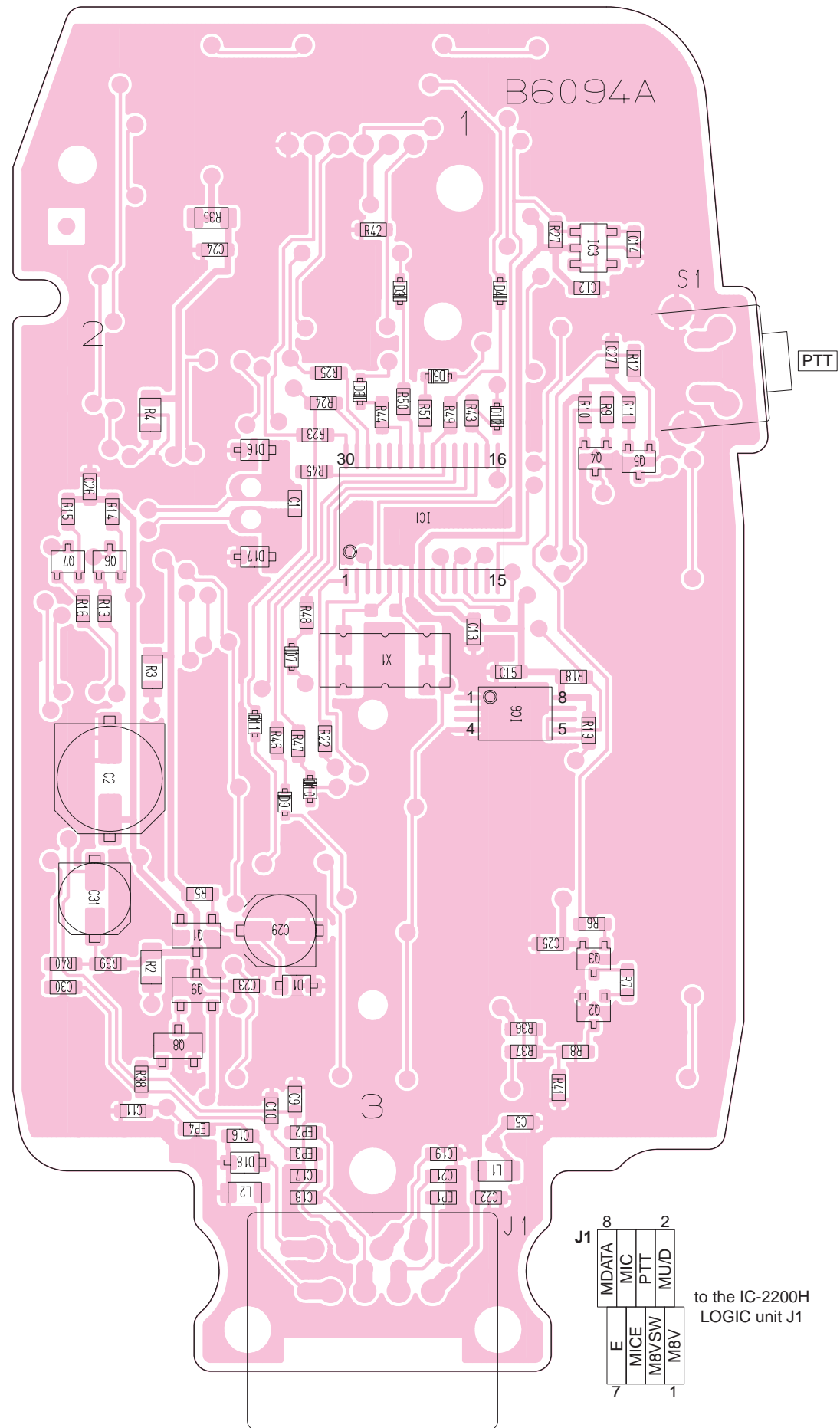

• BOTTOM VIEW (MAIN UNIT)

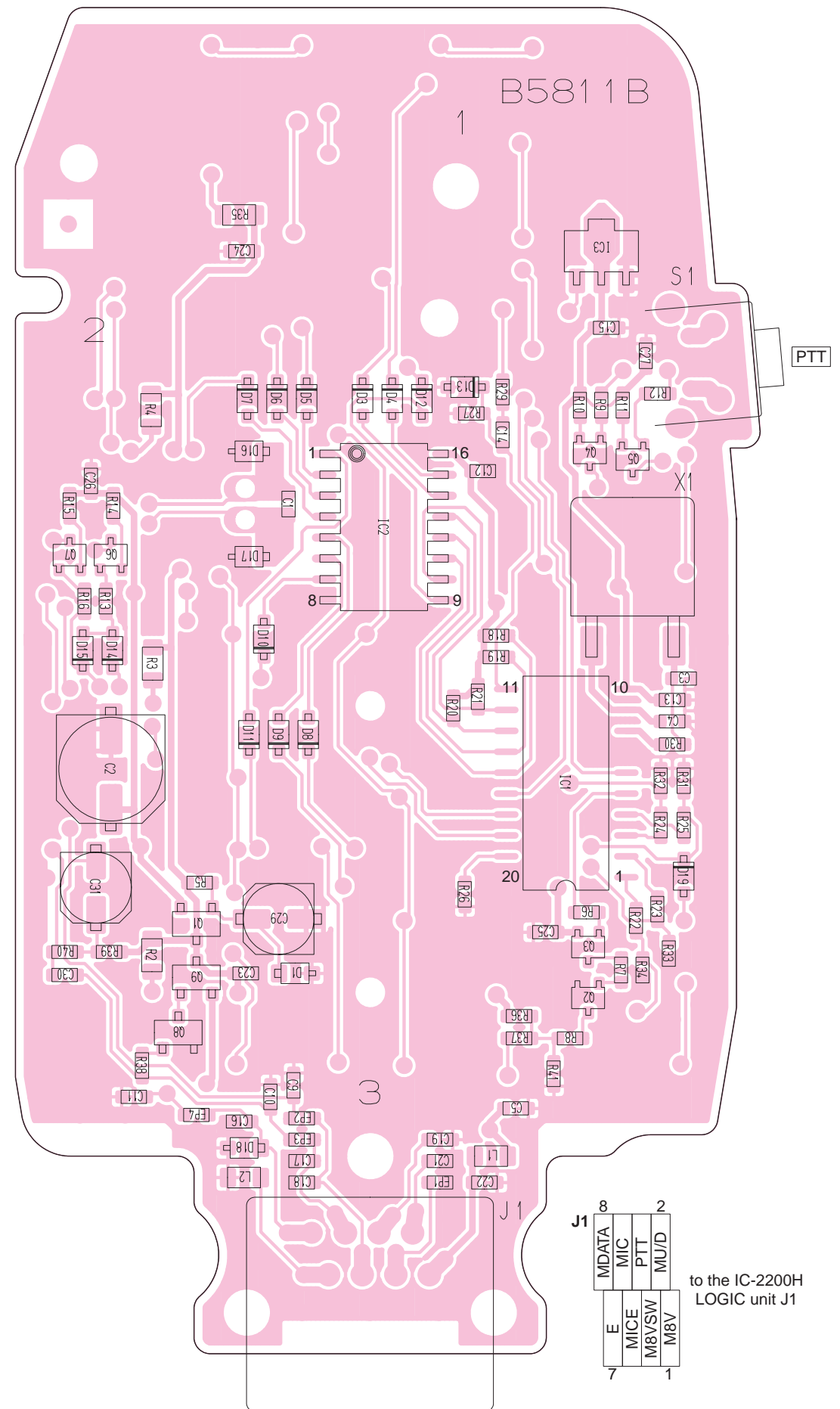

9-4 HM-118TN
• TOP VIEW

• BOTTOM VIEW (HM-118TN)

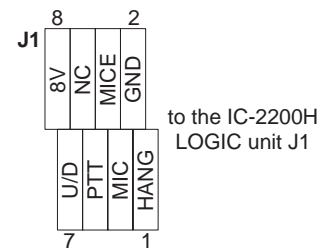
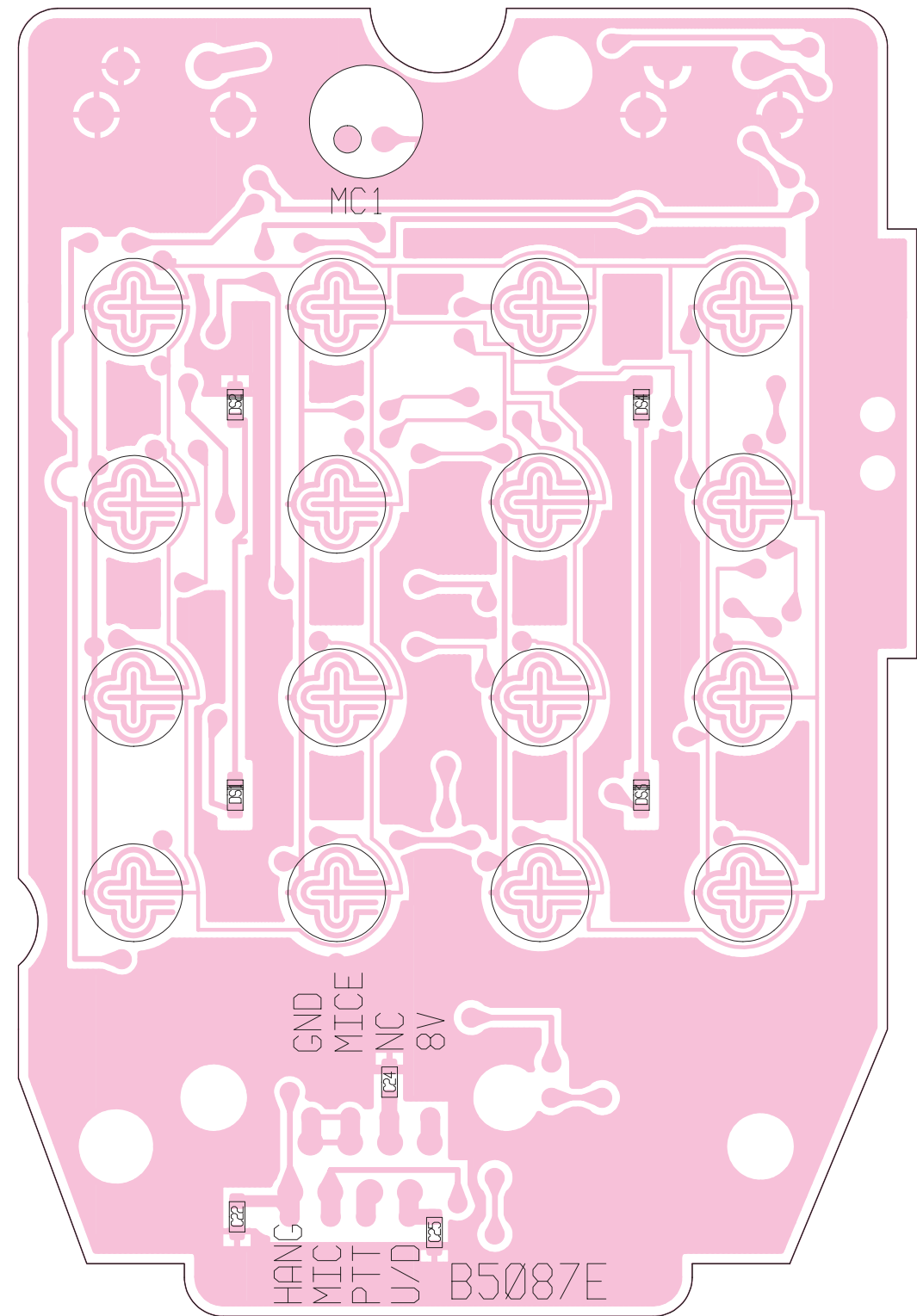
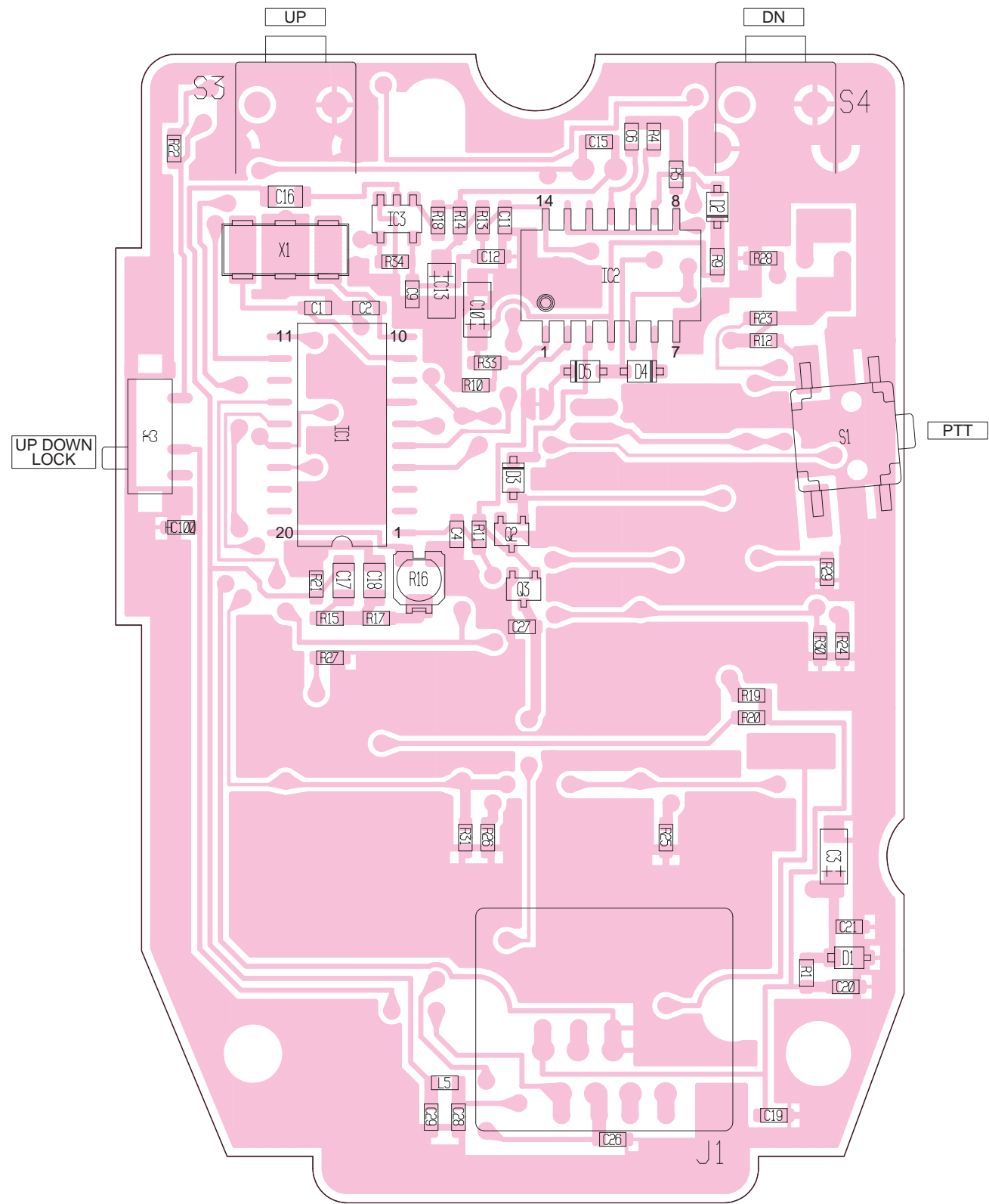

SECTION 10 BLOCK DIAGRAMS

10-1 IC-2200H

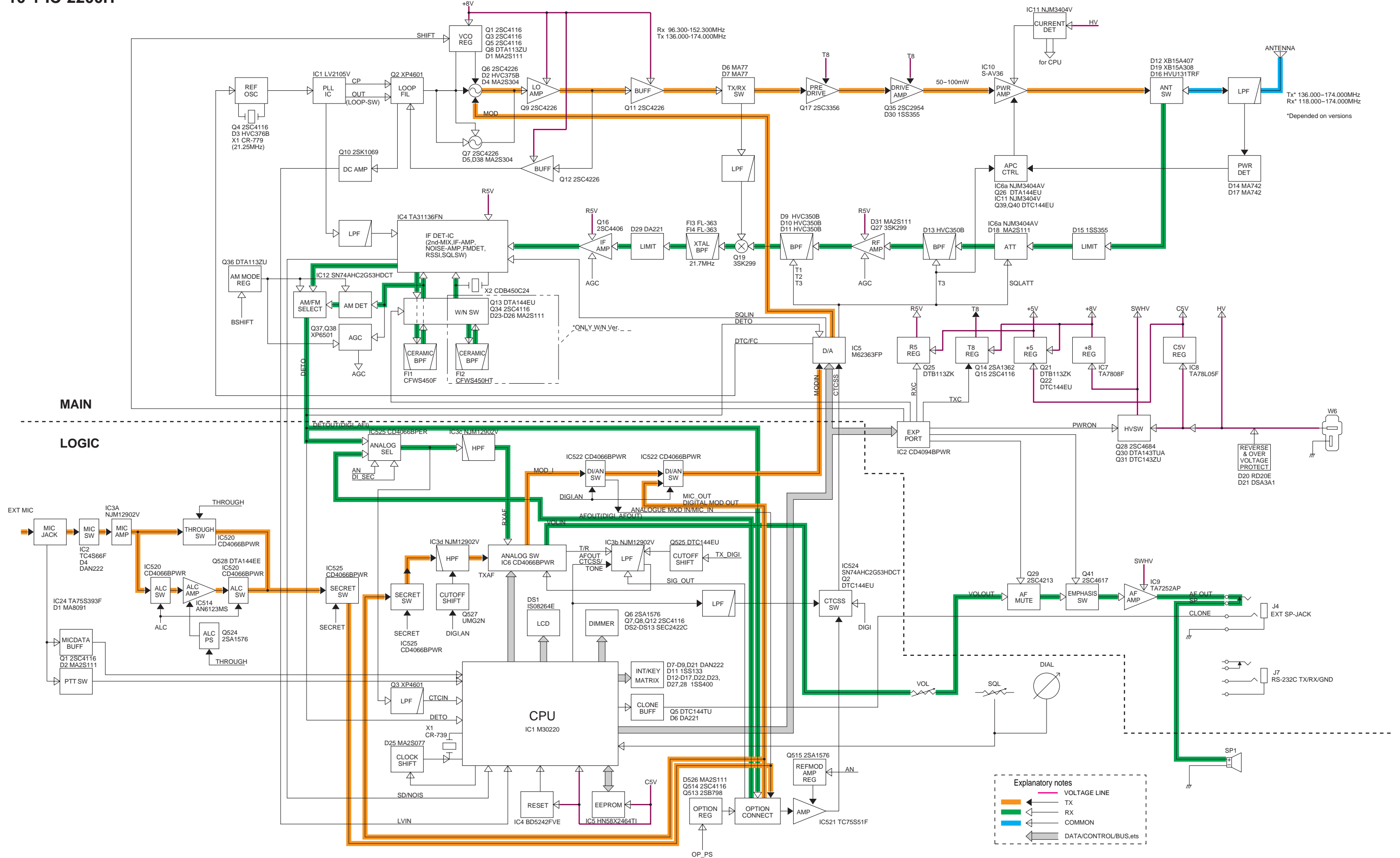

10-2 HM-133V

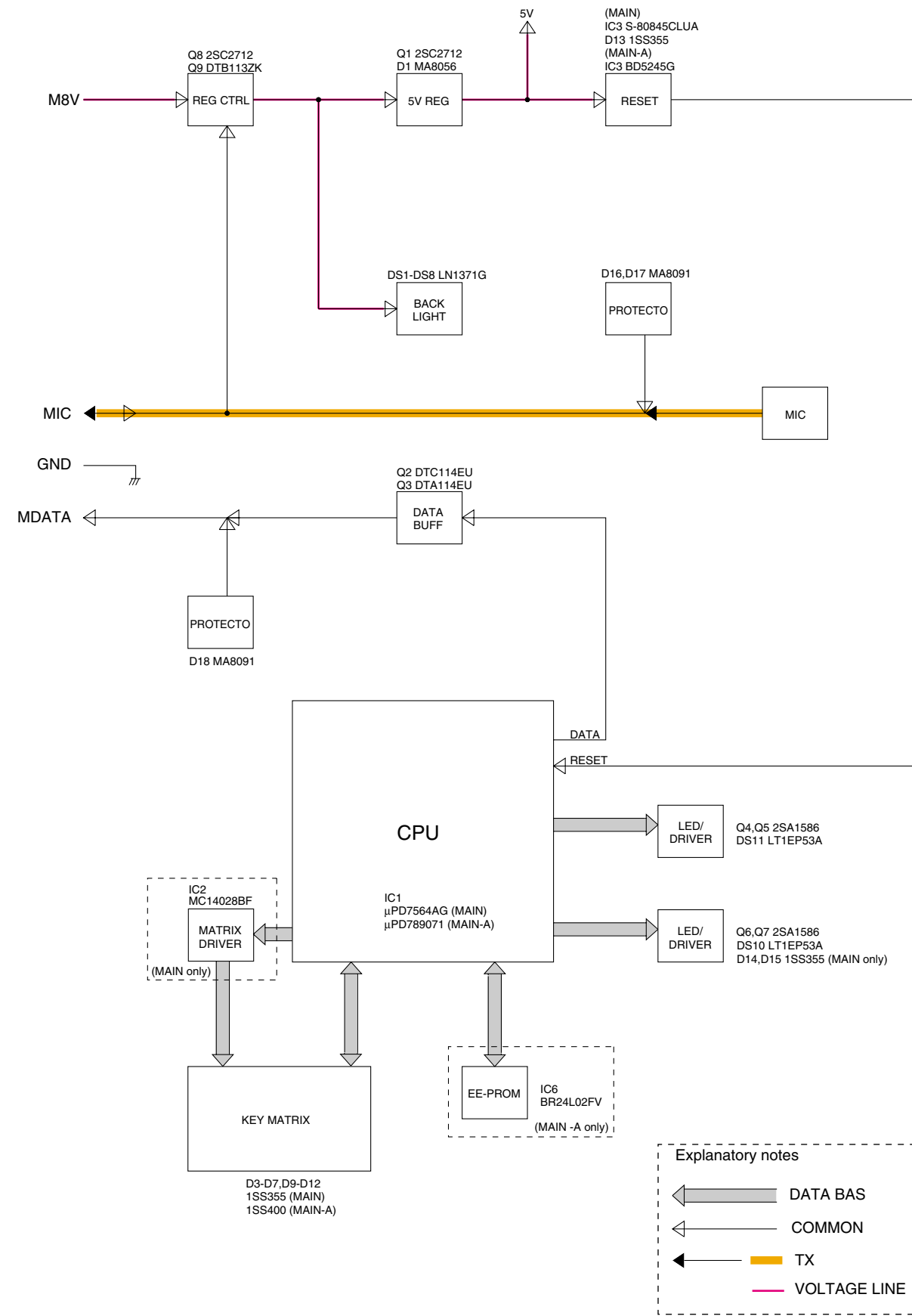

SECTION 11 VOLTAGE DIAGRAMS

11-1 LOGIC UNIT

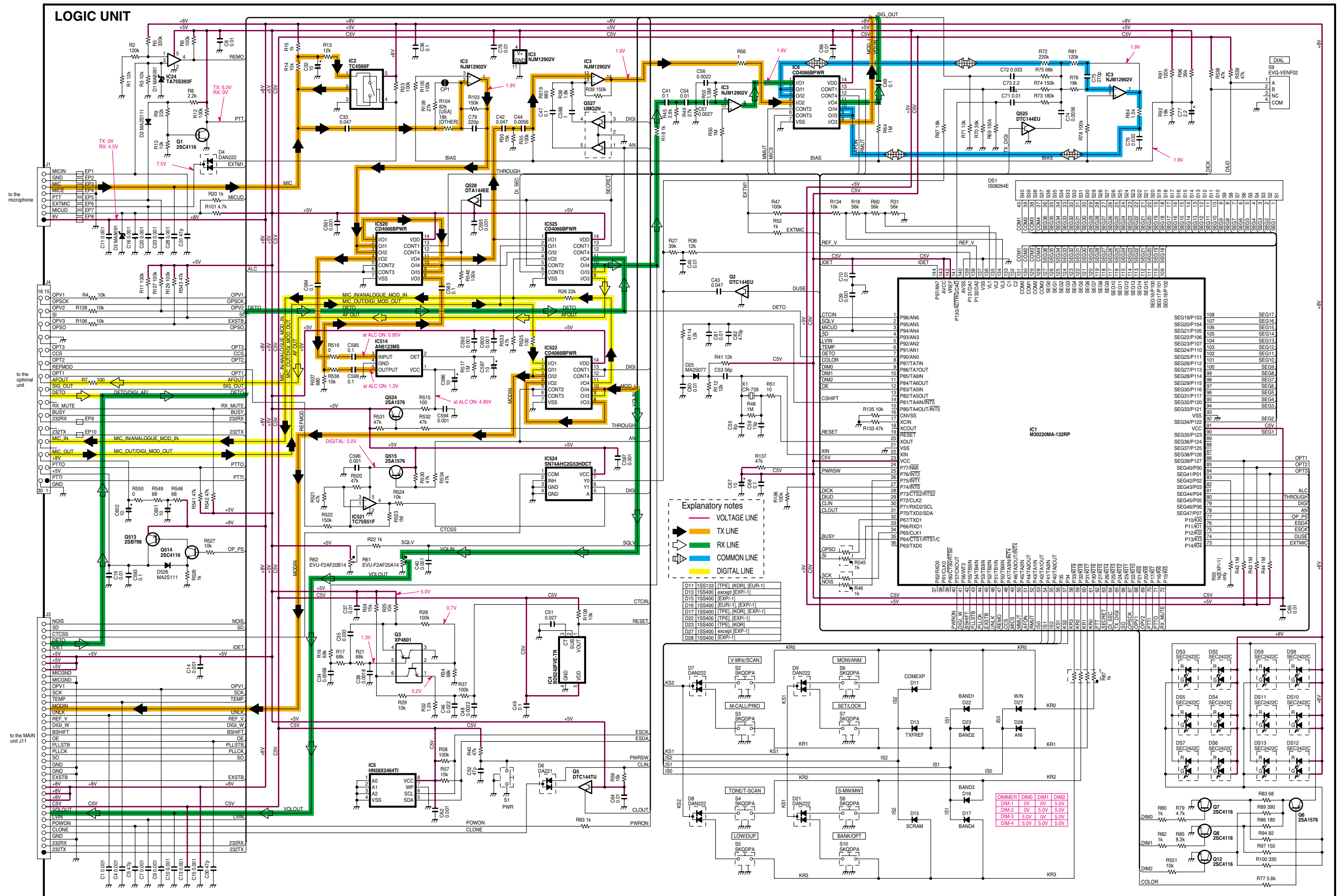

11-2 MAIN UNIT

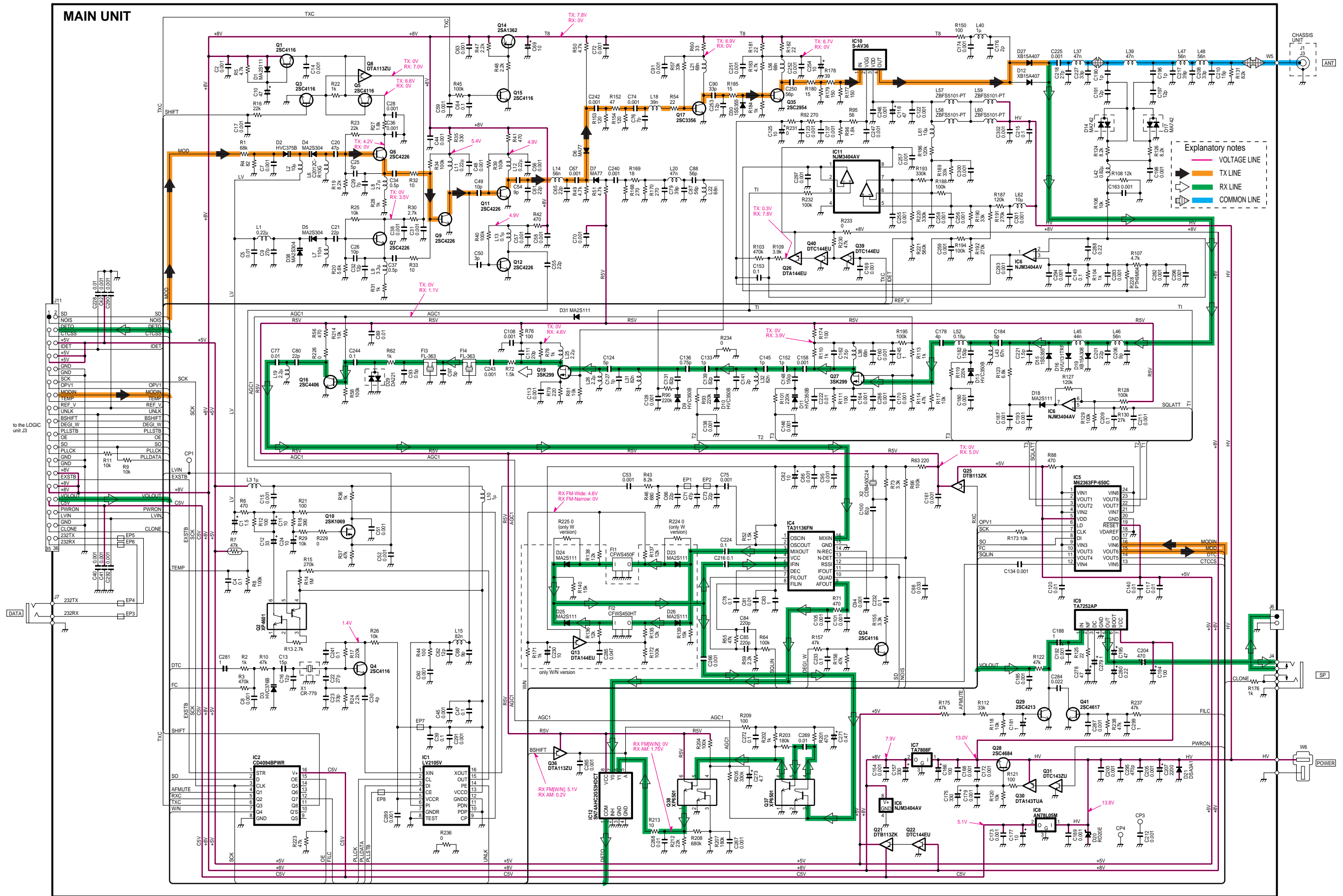

11-3 HM-133V

• MAIN UNIT

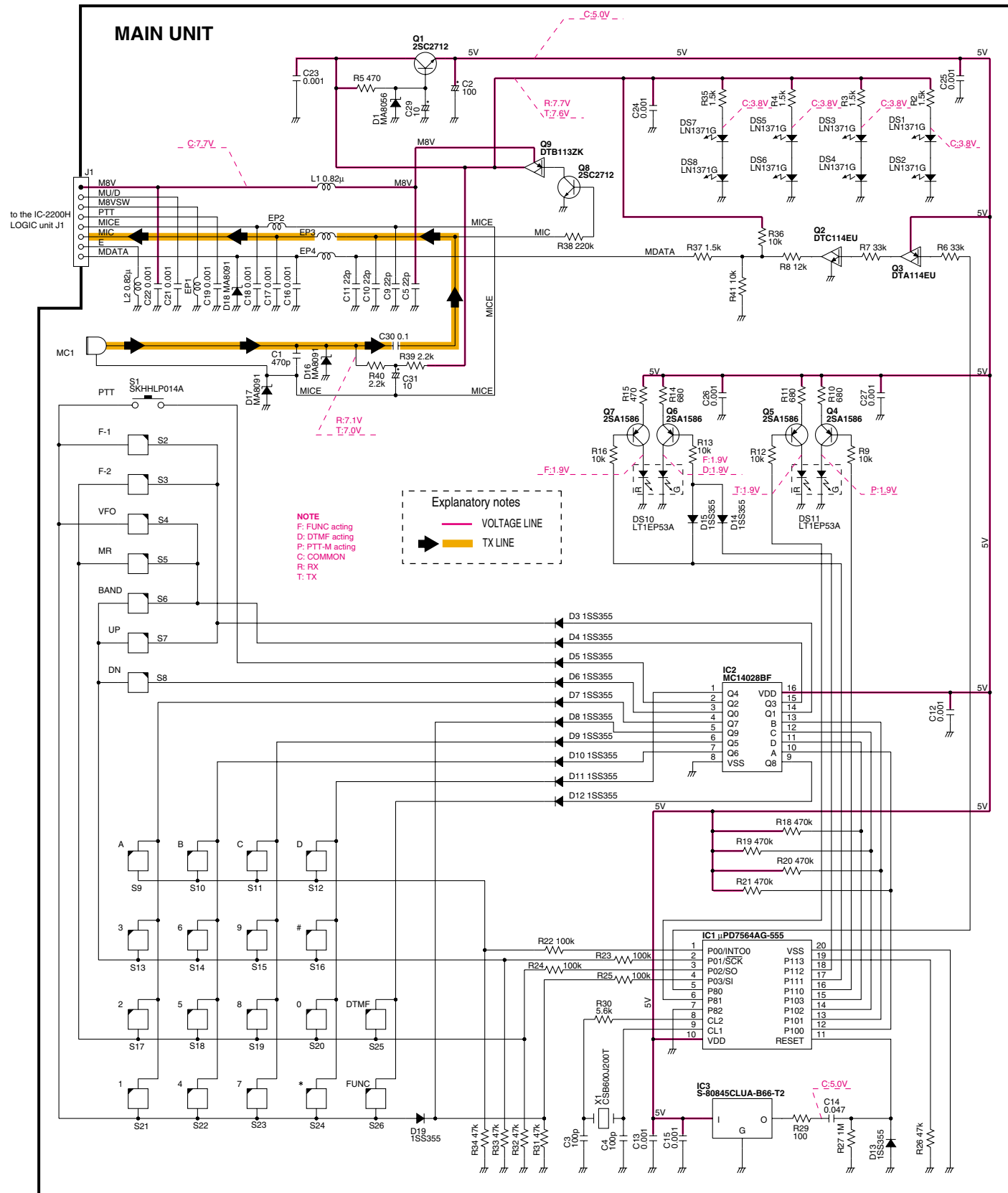

• MAIN-A UNIT

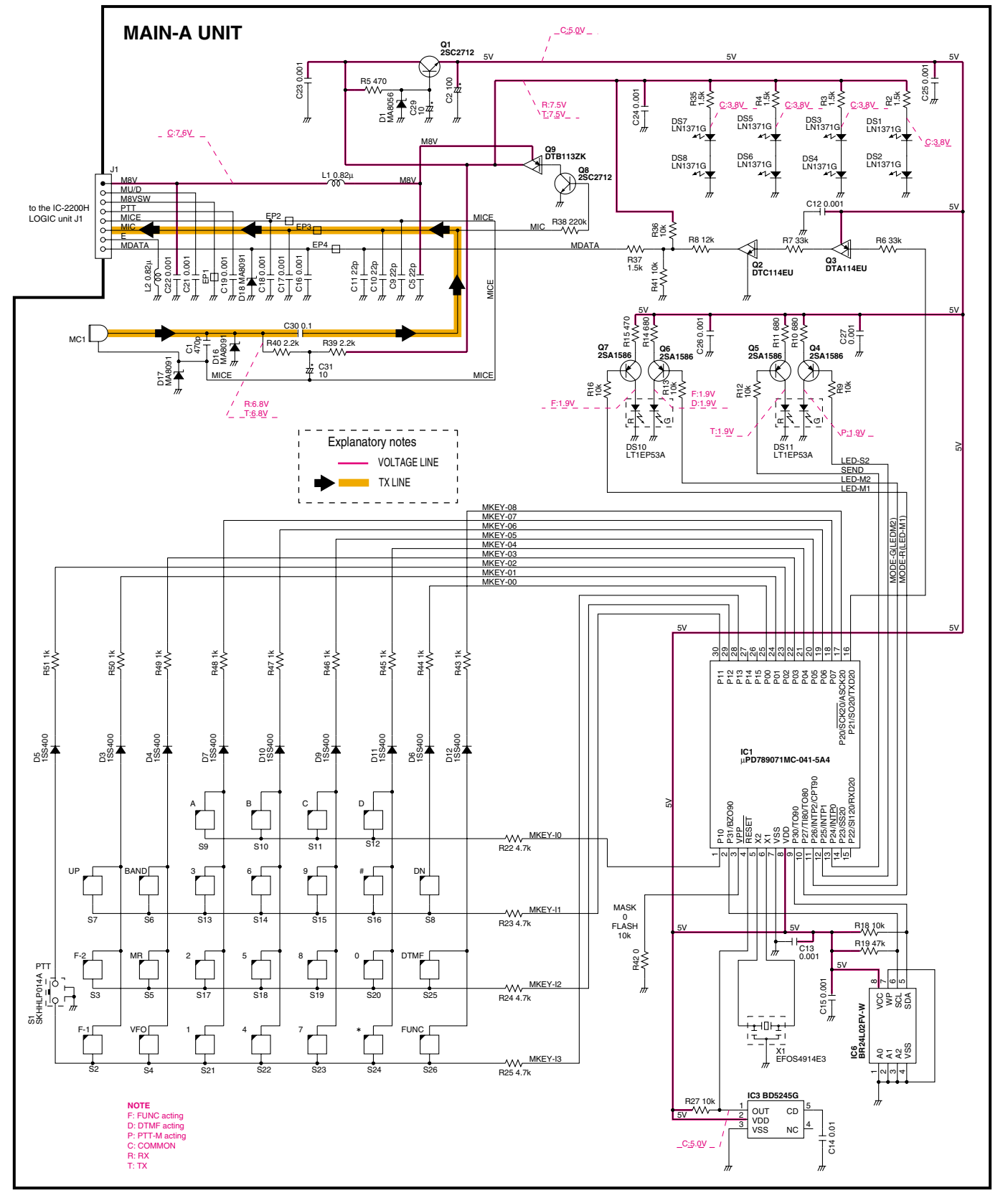

SECTION 12 HM-118/N (OPTIONAL UNIT)

12-1 INSIDE VIEW (HM-118/N)

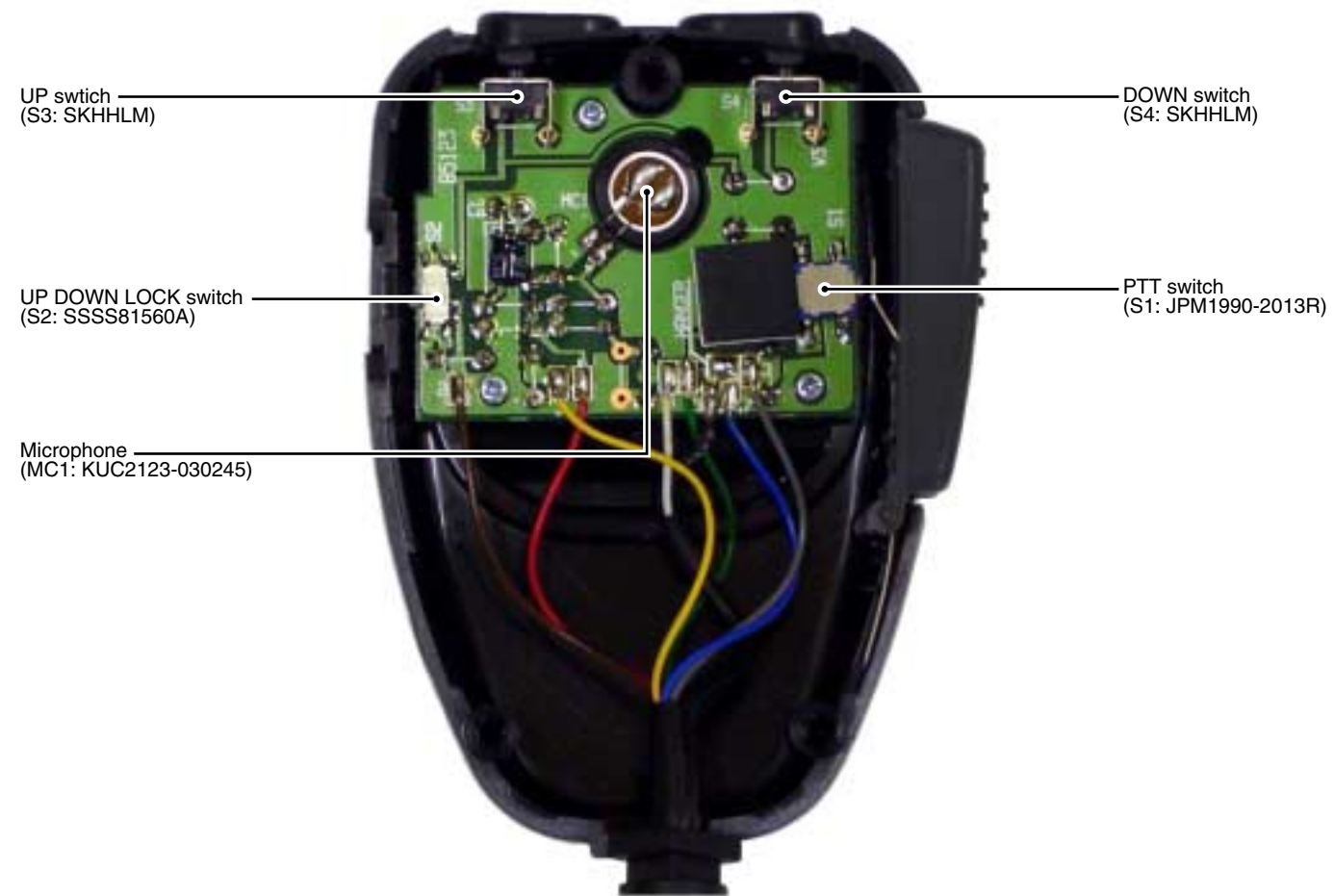

12-2 BOARD LAYOUTS

• TOP VIEW (MAIN UNIT)

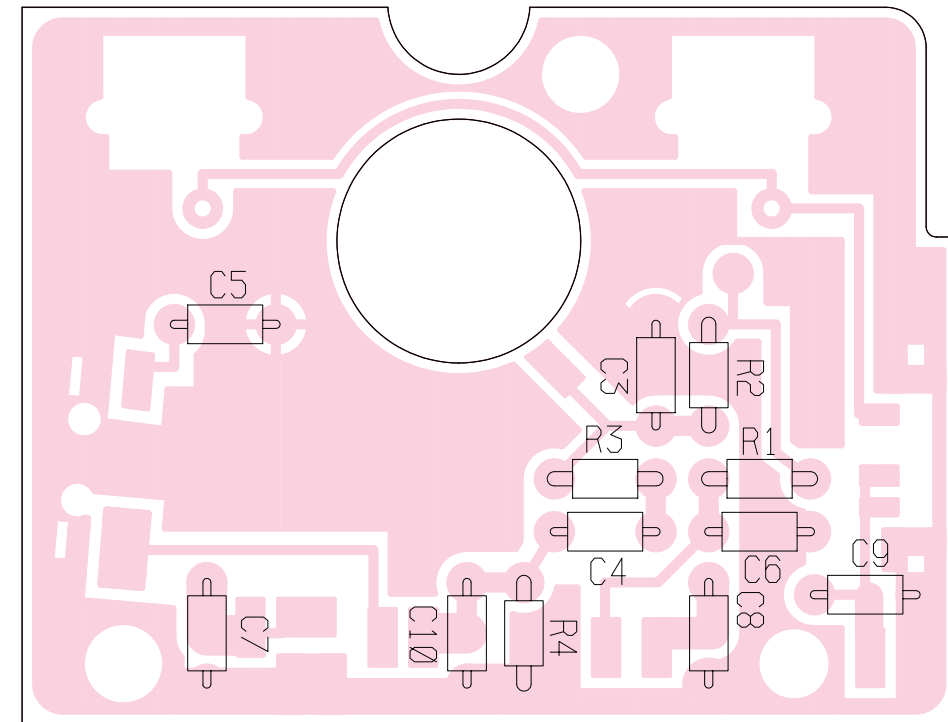

• TOP VIEW (MAIN-A UNIT)

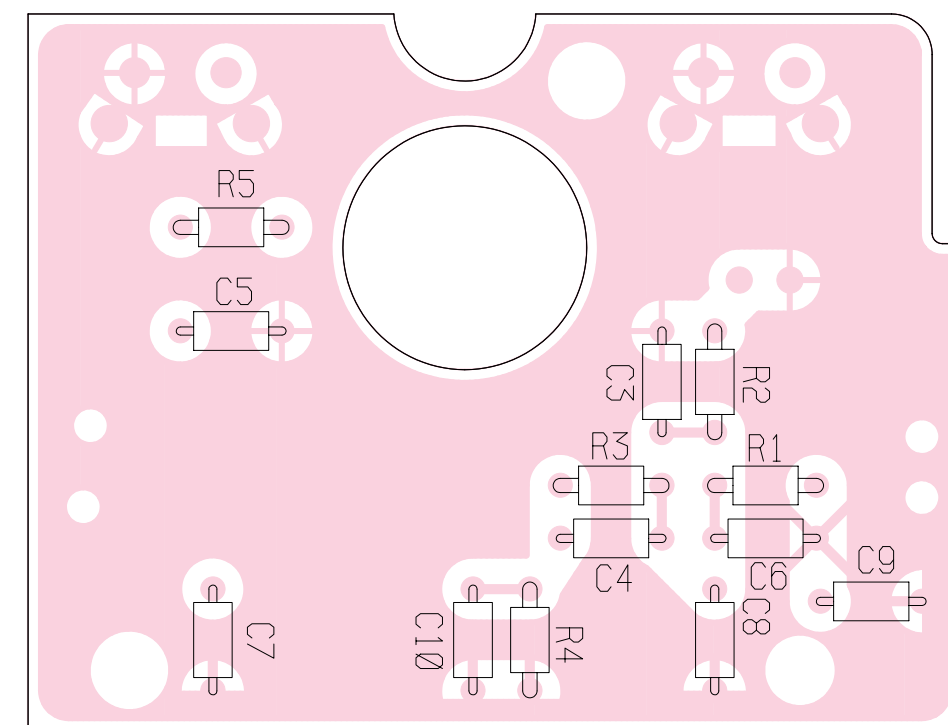

• BOTTOM VIEW (MAIN UNIT)

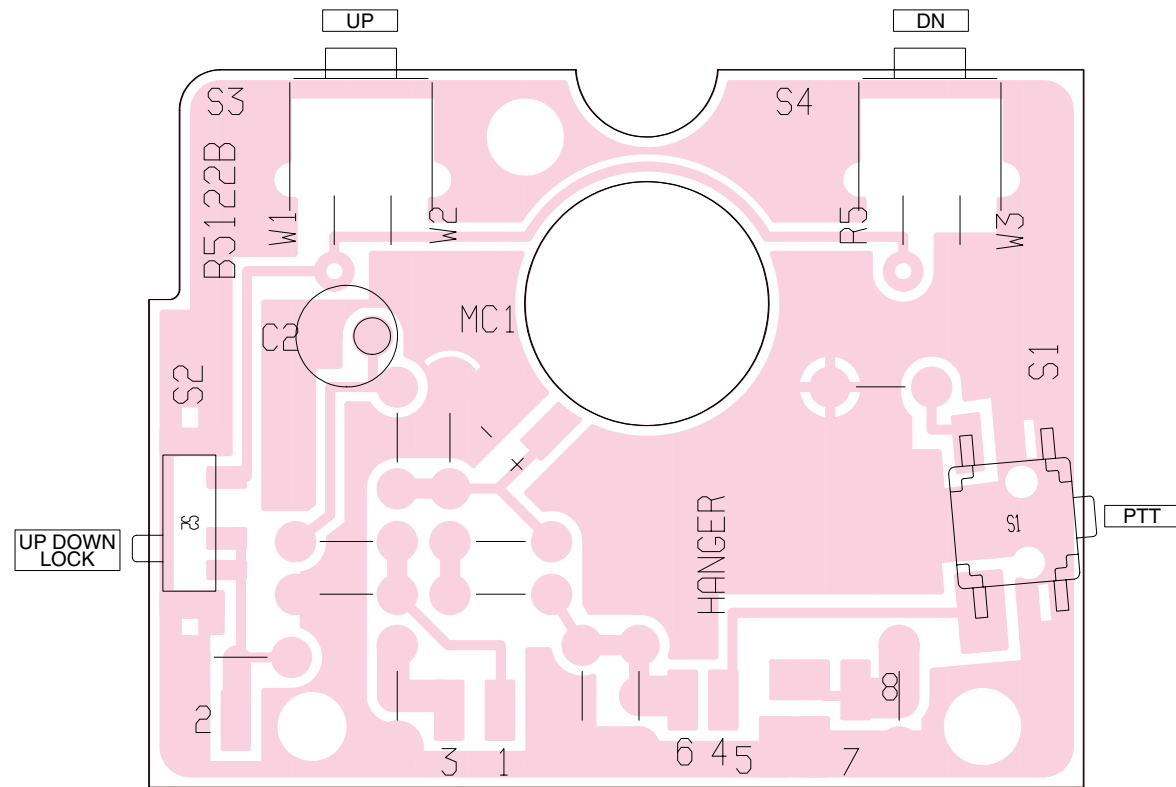

• BOTTOM VIEW (MAIN-A UNIT)

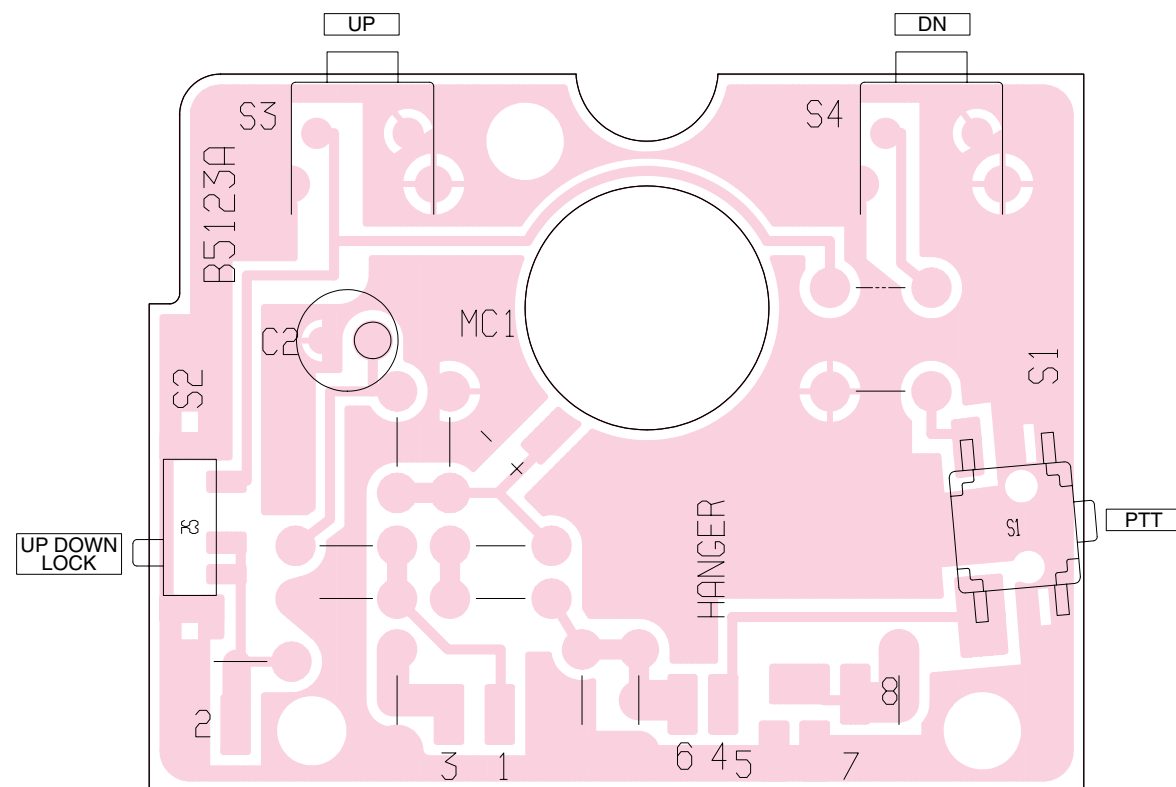

12-3 MECHANICAL PARTS LIST AND DISSASSEMBLY

[CHASSIS PARTS]

REF. NO.	ORDER NO.	DESCRIPTION	QTY.
MP1	8210015430	2129 front panel [HM-118]	1
	8210015431	2129 front panel-1 [HM-118N]	1
MP2	8210015330	1743 REAR PANEL [HM-118]	1
	8210015331	1743 REAR PANEL-1 [HM-118N]	1
MP4	8930046350	1743 hook plate	1
MP5	8930046530	1743 PTT button [HM-118]	1
	8930052400	2129 PTT button [HM-118N]	1
MP12	8930046930	1135 U/D button (B) [HM-118]	1
	8930025191	1135 U/D button-1 [HM-118N]	1
MP13	8610010640	Knob K-226	1
MP15	8810009760	Screw PH BT M3 × 12 ZK	2
MP16	8810009260	Screw PH BT 2 × 6 NI	3
MP18	8810008890	Screw FH M3 × 6 NI	1
MP19	8830001060	Nut M3 NI	1
MP25	8810009810	Screw PH BT M3 × 14 ZK	1
MP27	8930052390	1743 SW rubber [HM-118N]	1

[MAIN/MAIN-A UNIT]

REF. NO.	ORDER NO.	DESCRIPTION	QTY.
MC1	7700002120	Microphone KUC2123-030245	1
W1	8900008000	Cable OPC-784 [HM-118]	1
	8900008001	Cable OPC-784A [HM-118N]	1
S1	2230001020	Switch JPM1990-2013R	1
S2	2220000620	Switch SSSS81560A	1
S3	2260002500	Switch SKHLM	1
S4	2260002500	Switch SKHLM	1

Screw abbreviations BT: Self-tapping PH: Pan head
 FH: Flat head ZK: Black
 NI: Nickel

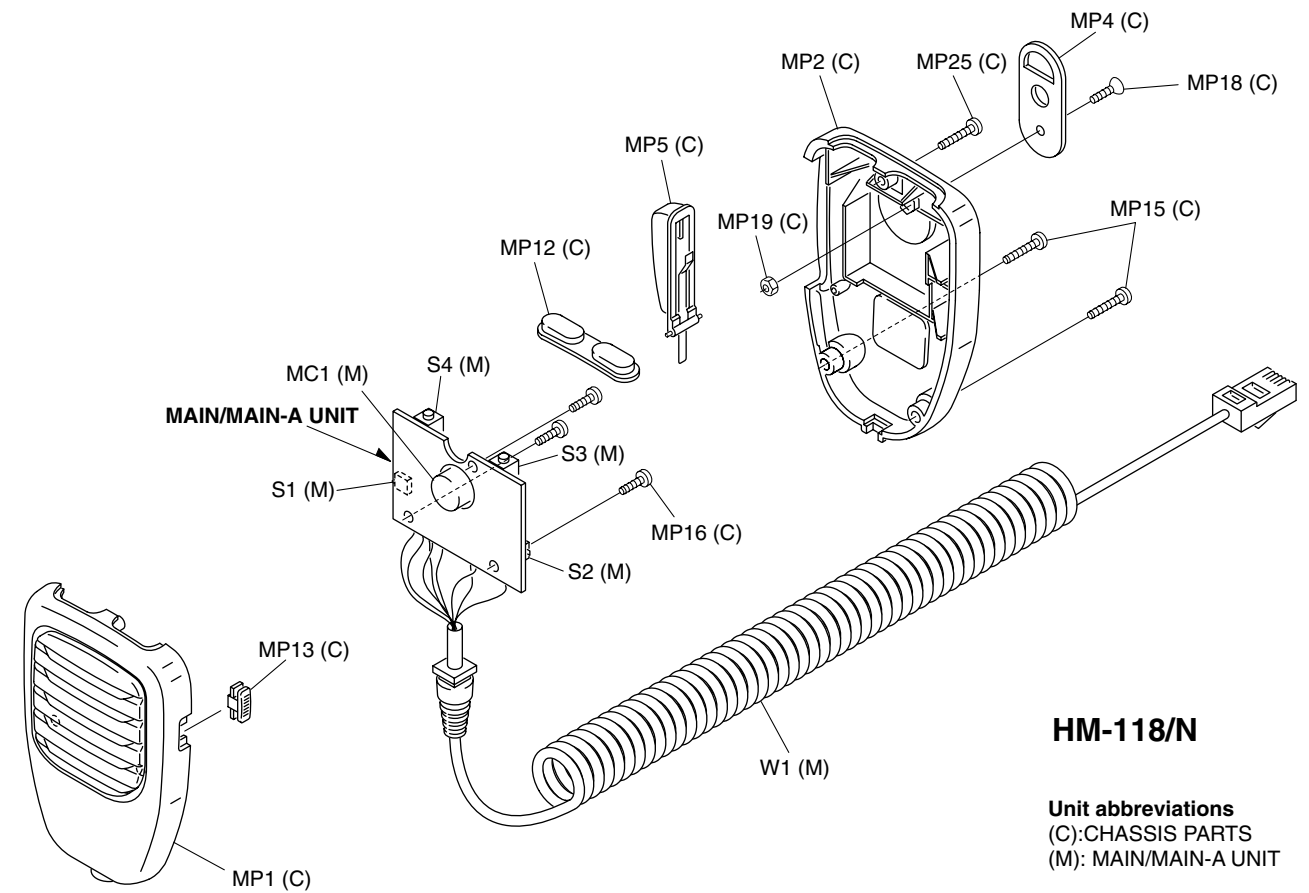

HM-118/N

Unit abbreviations
 (C): CHASSIS PARTS
 (M): MAIN/MAIN-A UNIT

SECTION 13 UT-108 (OPTIONAL UNIT)

13-1 BOARD LAYOUT • TOP VIEW

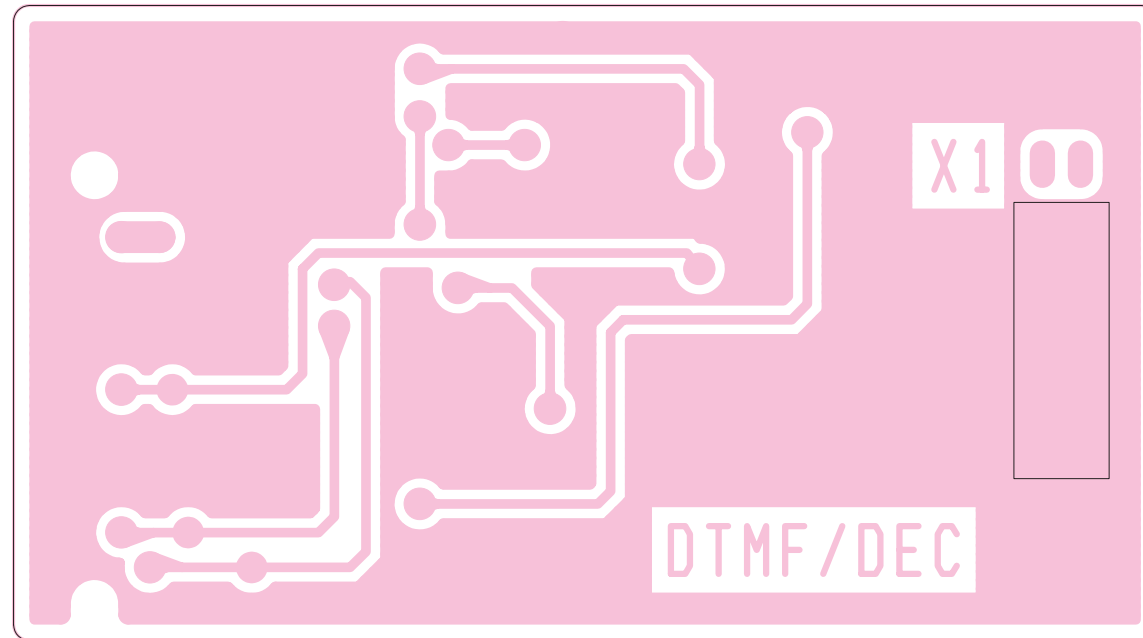

• BOTTOM VIEW

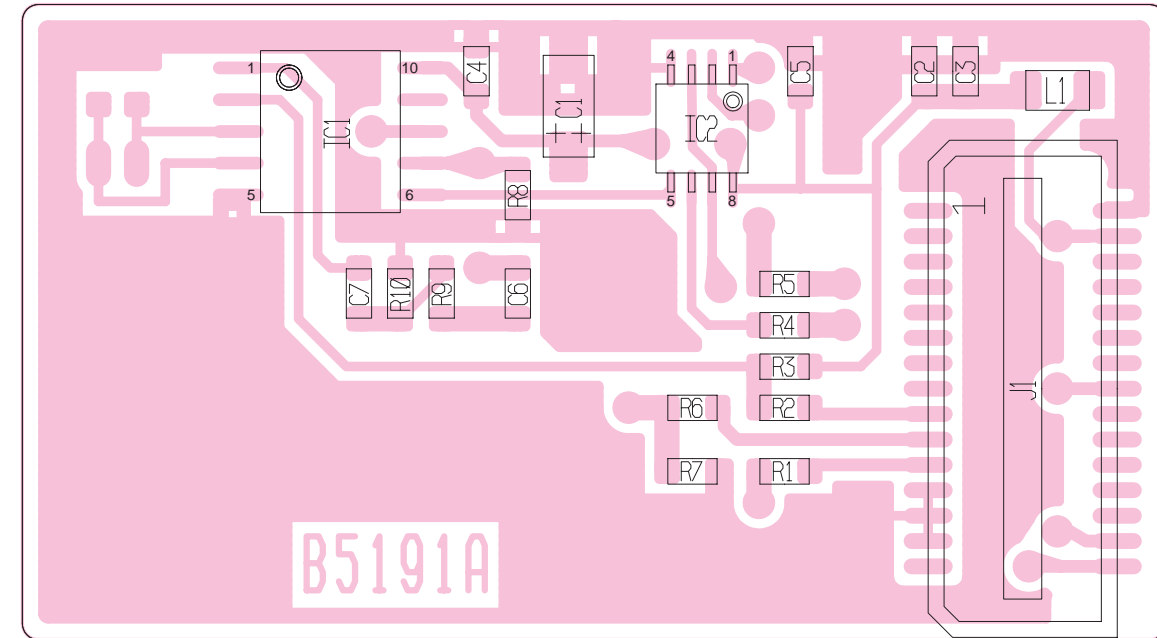

J1		
1	PTTIN_C	AGND
	PTTOUT	5V
	DMOD	VCC_8V
	AMODIN	TXD
	F_RXD	232_TX
	BUSY_C	232_RX
	RES	RMUTE
	NC	FMDDET
	NC	DAFOUT
	NC	REFMOD
	NC	NC
	GND	FLASH
	GND	RXD_2_C
	P01	TXD_2_C
15	NC	NC
		16

to the IC-2200H
LOGIC unit J4

SECTION 14 UT-115 (OPTIONAL UNIT)

14-1 BOARD LAYOUT • TOP VIEW

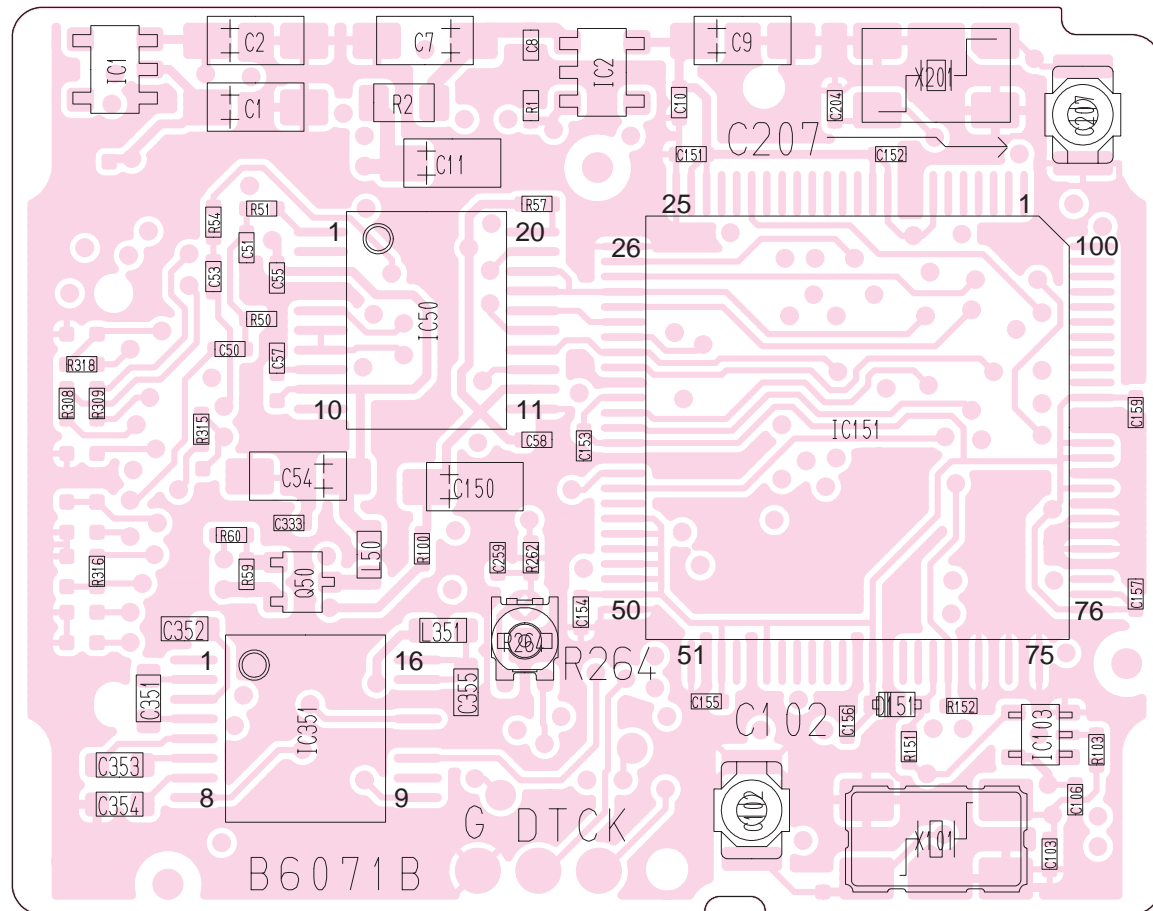

• BOTTOM VIEW

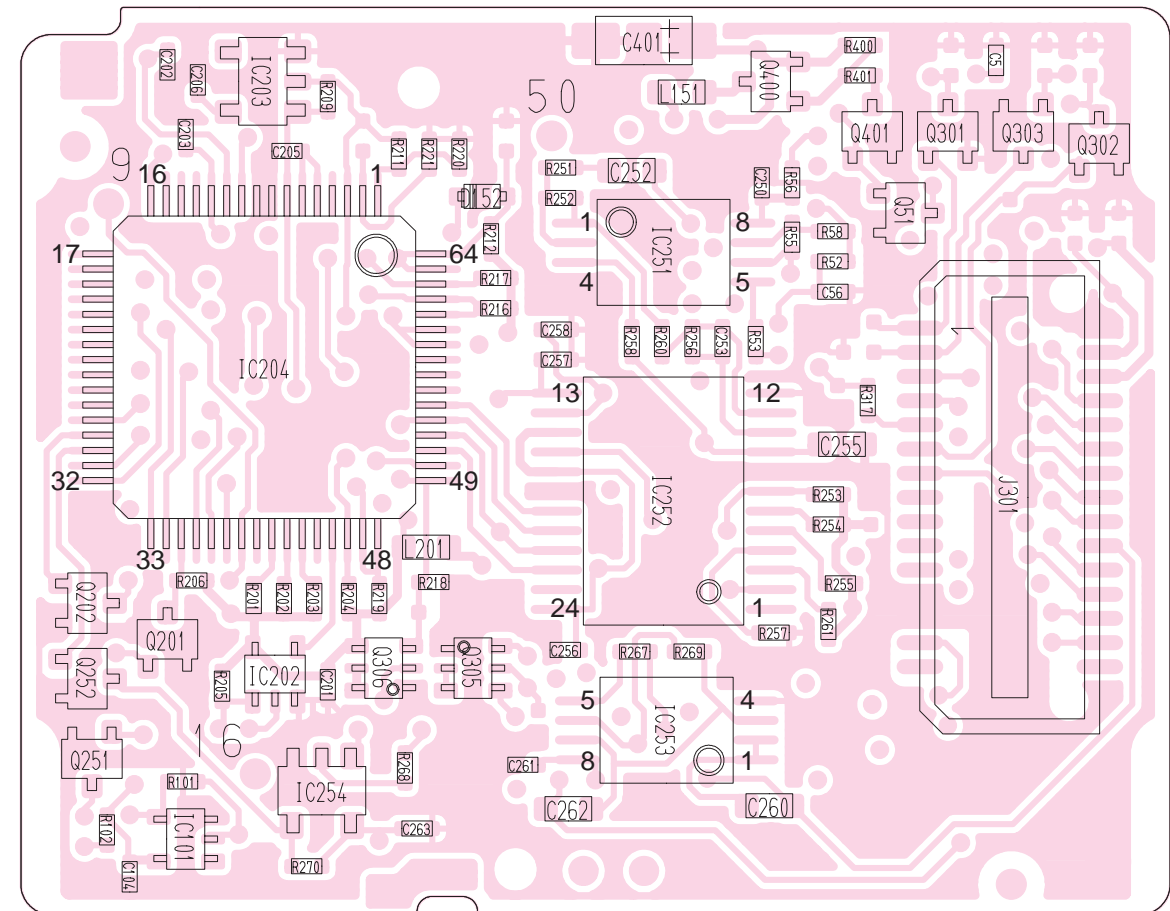

J301

1	PTTIN_C	AGND	30
	PTTOUT	5V	
	DMOD	VCC_8V	
	AMODIN	TXD	
	F_RXD	232_TX	
	BUSY_C	232_RX	
	RES	RMUTE	
	NC	FMDDET	
	NC	DAFOUT	
	NC	REFMOD	
	NC	NC	
	GND	FLASH	
	GND	RXD_2_C	
	P01	TXD_2_C	
15	NC	NC	16

to the IC-2200H LOGIC unit J4

14-2 SEMICONDUCTOR INFORMATION

• TRANSISTORS AND FET'S

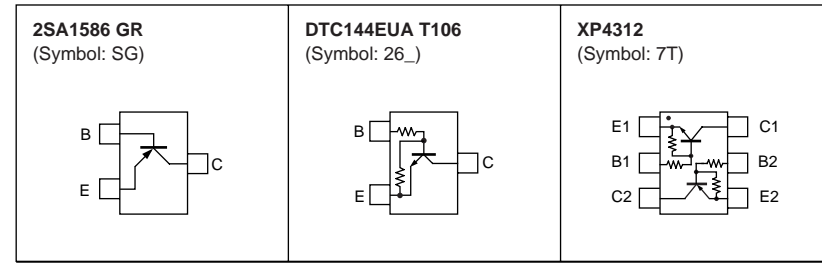

• DIODES

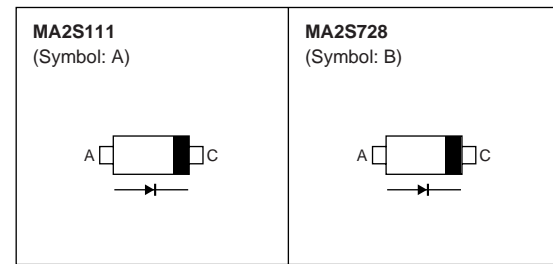

14-3 BLOCK DIAGRAM

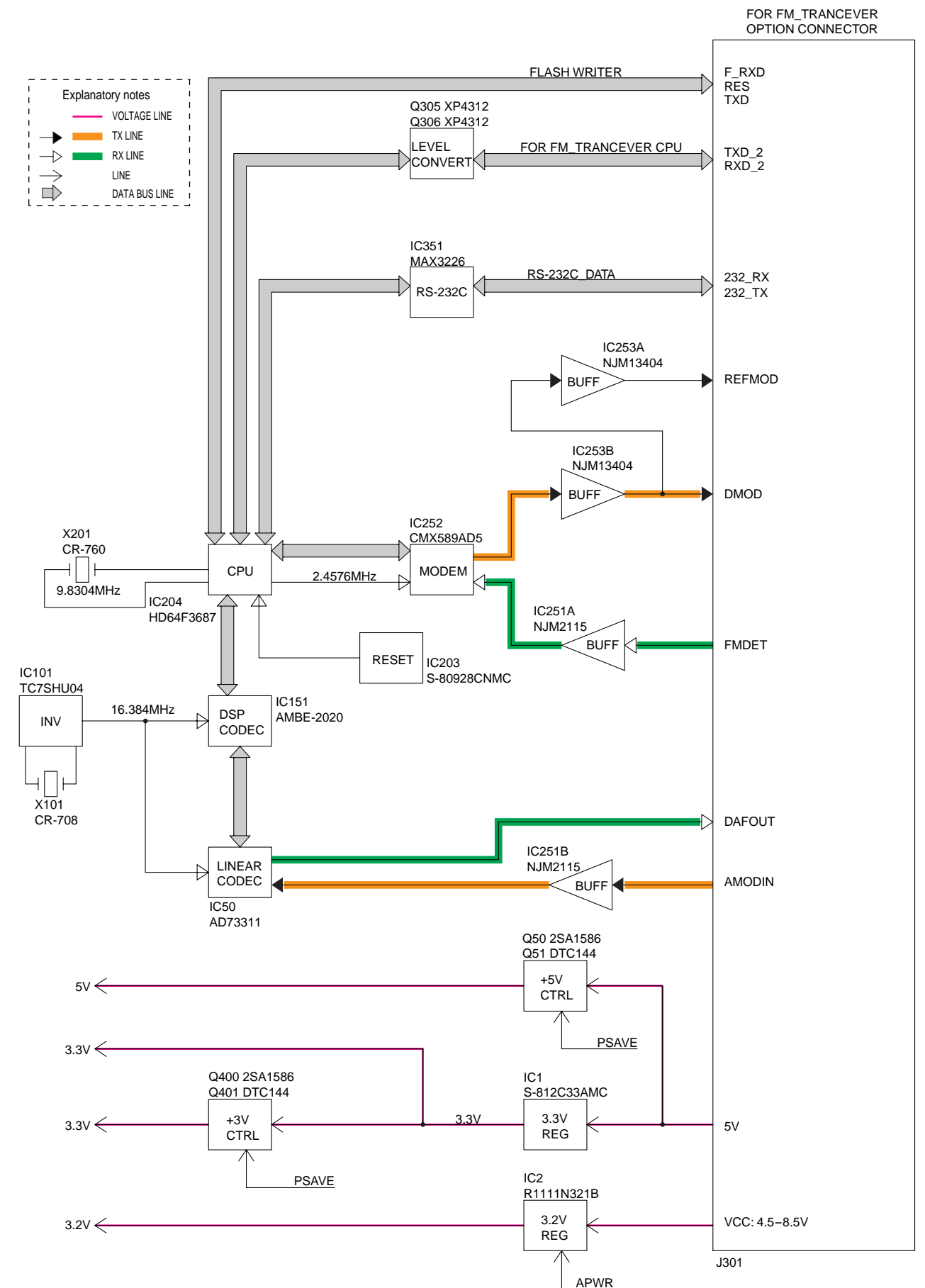

14-4 VOLGTAGE DIAGRAM

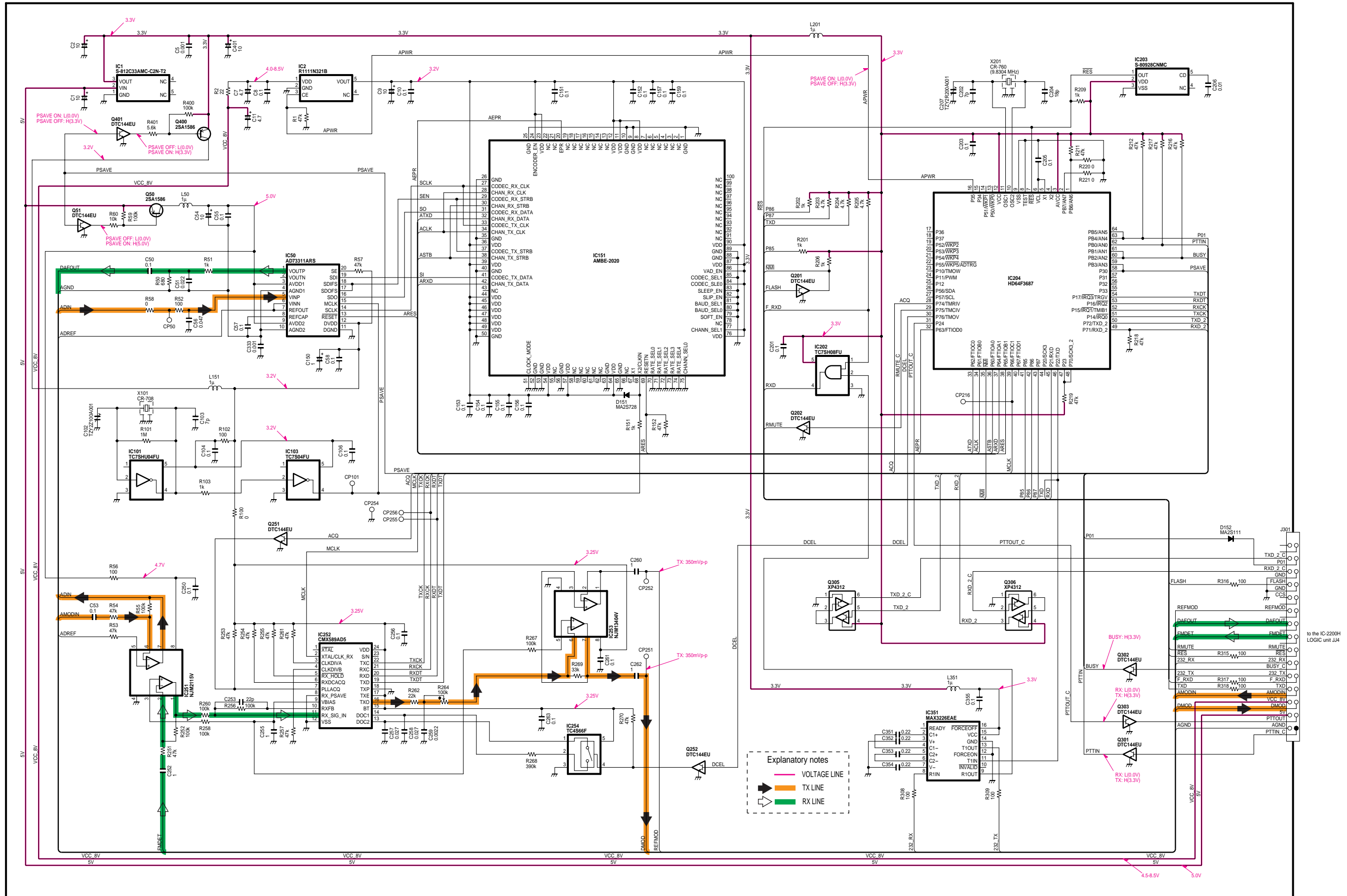

Icom Inc.

1-1-32, Kamiminami, Hirano-ku, Osaka 547-0003, Japan
Phone : +81 (06) 6793 5302
Fax : +81 (06) 6793 0013
URL : <http://www.icom.co.jp/world/index.html>

Icom America Inc.

<Corporate Headquarters>
2380 116th Avenue N.E., Bellevue, WA 98004, U.S.A.
Phone : +1 (425) 454-8155 Fax : +1 (425) 454-1509
URL : <http://www.icomamerica.com>
<Customer Service>
Phone : +1 (425) 454-7619

Icom Canada

Glenwood Centre #150-6165
Highway 17 Delta, B.C., V4K 5B8, Canada
Phone : +1 (604) 952-4266 Fax : +1 (604) 952-0090
URL : <http://www.icomcanada.com>

Icom (Australia) Pty. Ltd.

A.B.N. 88 006 092 575
290-294 Albert Street, Brunswick, Victoria, 3056, Australia
Phone : +61 (03) 9387 0666 Fax : +61 (03) 9387 0022
URL : <http://www.icom.net.au>

Icom New Zealand

146A Harris Road, East Tamaki,
Auckland, New Zealand
Phone : +64 (09) 274 4062 Fax : +64 (09) 274 4708
URL : <http://www.icom.co.nz>

Beijing Icom Ltd.

1305, Wanshang Plaza, Shijingshan Road, Beijing China
Phone : +86 (010) 6866 6337 Fax : +86 (010) 6866 3553
URL : <http://www.bjicom.com>

Icom (Europe) GmbH

Communication Equipment
Himmelgeister Str. 100, D-40225 Düsseldorf, Germany
Phone : +49 (0211) 346047 Fax : +49 (0211) 333639
URL : <http://www.icomeurope.com>

Icom Spain S.L

Crta. de Gracia a Manresa Km. 14,750
08190 Sant Cugat del Valles Barcelona, SPAIN
Phone : +34 (93) 590 26 70 Fax : +34 (93) 589 04 46
URL : <http://www.icomspain.com>

Icom (UK) Ltd.

Unit 9, Sea St., Herne Bay, Kent, CT6 8LD, U.K.
Phone : +44 (01227) 741741 Fax : +44 (01227) 741742
URL : <http://www.icomuk.co.uk>

Icom France S.a

Zac de la Plaine, 1, Rue Brindejonc des Moulinais
BP 5804, 31505 Toulouse Cedex, France
Phone : +33 (5) 61 36 03 03 Fax : +33 (5) 61 36 03 00
URL : <http://www.icom-france.com>

Asia Icom Inc.

6F No. 68, Sec. 1 Cheng-Teh Road, Taipei, Taiwan, R.O.C.
Phone : +886 (02) 2559 1899 Fax : +886 (02) 2559 1874
URL : <http://www.asia-icom.com>

Count on us!

Icom Inc.

1-1-32, Kamiminami, Hirano-ku, Osaka 547-0003, Japan

S-14017HZ-C1
© 2004 Icom Inc.