



# LA1061M

## Antenna Switching Controller

### Overview

The LA1061M is an antenna switching controller for mobile radio equipment.

The LA1061M uses a number of inputs from the receiver circuitry to select the main antenna or sub-antenna according to signal strength and quality. Weak and strong signals are detected with the S-meter DC voltage and F.E. AGC voltage, respectively. Multi-path distortion is detected from the AC component of the IF output, using the same high-sensitivity counter circuit as in Sanyo's earlier LA1060 device. An auxiliary circuit keeps the main antenna selected for a fixed time period when reception conditions outside a moving vehicle are changing rapidly.

The LA1061M is available in surface-mount 8-pin DIPs, facilitating construction of compact equipment. It operates from a single 7 to 12V power supply.

### Package Dimensions

unit: mm

#### 3111-MFP14S

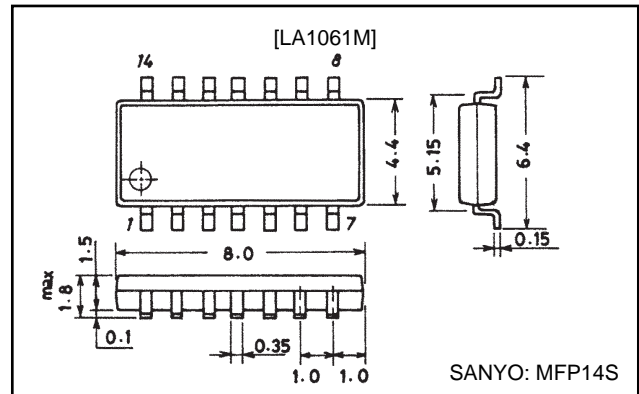

### Features

- Uses Sanyo's proprietary AGC amplifier and detector, providing accurate detection of multi-path distortion.
- High-current Main and Sub-antenna switching outputs.
- Antenna switching frequency limiting circuit.
- On-board comparators for F.E AGC (strong signal) and S-meter DC (weak signal) detection.
- Surface-mount 14-pin MFP.

### Specifications

#### Maximum Ratings at Ta=25°C

Parameter	Symbol	Conditions	Ratings	Unit
Maximum supply voltage	V <sub>CC</sub> max		14	V
Allowable power dissipation	P <sub>d</sub> max		182	mW
Operating temperature	T <sub>opr</sub>		-30 to +80	°C
Storage temperature	T <sub>stg</sub>		-40 to +125	°C
Maximum flow-out current	I <sub>4</sub>	Pin 4	1	mA
	I <sub>5</sub>	Pin 5	10	mA
	I <sub>6</sub>	Pin 6	10	mA
	I <sub>9</sub>	Pin 9	2	mA
	I <sub>10</sub>	Pin 10	5	mA
	I <sub>12</sub>	Pin 12	2	mA
Maximum apply voltage	V <sub>13</sub>	Pin 13	V <sub>CC</sub>	V
	V <sub>14</sub>	Pin 14	V <sub>CC</sub>	V

# LA1061M

## Operating Conditions at $T_a=25^\circ\text{C}$

Parameter	Symbol	Conditions	Ratings	Unit
Recommended supply voltage	$V_{CC}$		8	V
Operating voltage range	$V_{CC\text{ op}}$		7 to 12	V

## Operation Characteristics at $T_a=25^\circ\text{C}$ , $V_{CC}=8\text{V}$ , $f=100\text{kHz}$ sine wave

Parameter	Symbol	Conditions	Ratings			Unit
			min	typ	max	
Current drain	$I_{CC}$	No input, $I_5$ and $I_6$ are not included.	4.5	7	12	mA
Pin 5 'H'-level voltage	$V_5$	$1\text{k}\Omega$ to ground	5.0	6.0	7.0	V
Pin 6 'H'-level voltage	$V_6$	$1\text{k}\Omega$ to ground	5.0	6.0	7.0	V
Noise amp gain	$G_{v1}$	$V_{IN}=3\text{mVrms}$ , $f=100\text{kHz}$	33	36	39	dB
	$G_{v2}$	$V_{IN}=100\text{mVrms}$ , $f=100\text{kHz}$	10	13	16	dB
Noise detection sensitivity	NDS	Noise AGC off	9	12	15	mVrms
Noise count number	NCN	$V_{IN}=30\text{mVrms}$ , $f=100\text{kHz}$ , sine wave		10		
Gate time 1	$t_{G1}$	Noise AGC off	120	150	180	$\mu\text{s}$
Pin 9 voltage	$V_9$	$V_{IN}=100\text{mVrms}$ , $f=100\text{kHz}$ , $R_g=300\text{k}\Omega$	7.0	7.7	8.0	V
Strong signal comparator threshold	$V_{th14}$		0.8	1.0	1.2	V
Weak signal comparator threshold	$V_{th13}$		1.8	2.0	2.2	V
Gate time 2	$t_{G2}$		2	4	6	ms
Gate time 3	$t_{G3}$		13	23	40	ms
Switching frequency limit maximum count	HCN			15		

## Equivalent Circuit Block Diagram

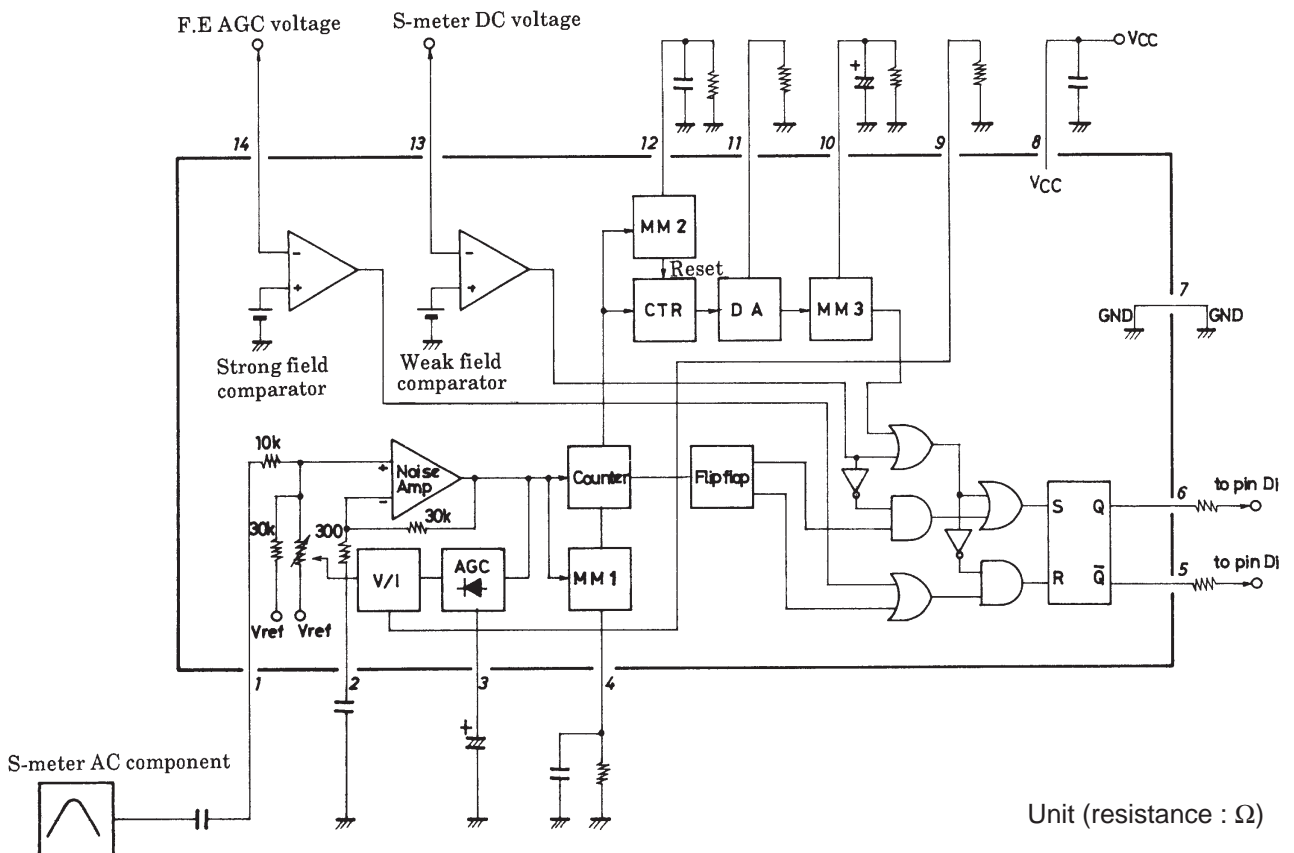



**Functional Description**

**General Operation**

The LA1061M has two inputs for weak and strong signal detection, and one for multi-path distortion detection. It has two outputs for Main and Sub-antenna selection, one of which is selected according to the state of the inputs. Both outputs can directly drive an antenna switching pin diode.

**Signal Strength Detection**

Each signal strength detection input has a built-in comparator. The weak signal comparator (pin 13) is driven by the S-meter DC voltage and has a threshold of approximately 2V. The antenna switching logic selects the Main antenna when the voltage on this pin is lower than the threshold, regardless of the state of the other inputs.

The strong signal detector (pin 14) is driven by the F.E. AGC voltage and has a threshold of approximately 1V. The antenna switching logic selects the Sub-antenna if the voltage on this pin is lower than the threshold, the weak signal comparator is off, and the multi-path distortion detector is not already on.

**Multi-path Distortion Detection**

The IF output signal is high-pass filtered and the resulting noise signal input through a coupling capacitor to pin 1, the LA1061M amplifies this signal and applies AGC to it. The AGC amplifier is designed to detect multi-path distortion without amplifying noise due to a weak IF signal. The number of noise pulses within the period set by the time constant on pin 4 is counted. If it exceeds a certain limit, and the strong signal detector is not already on, the antenna switching logic selects the Main antenna.

**Switching Frequency Detection**

The LA1061M counts the number of antenna changes within the time interval set by the time constant on pin 12. The internal D/A converter outputs a current on pin 11, which is converted to a voltage by the resistor connected to this pin. If this voltage exceeds a certain value, that is, the switching frequency is too high, the Main antenna is selected for the period set by the time constant on pin 10. The Main antenna is selected for this time regardless of the state of the other inputs.

**Pin Description**

Unit (resistance : Ω, capacitance : F)

Pin No.	Function	External circuits	Notes
1	Noise input	<p>Isolate noise components present in the IF output signal with a high-pass filter, and input via a decoupling capacitor.</p> <p>(Under development)</p>	<p>The input impedance of the LA 1061M varies with input level. The minimum value is 10kΩ.</p>

Continued on next page.

# LA1061M

Continued from preceding page.

Unit (resistance :  $\Omega$ , capacitance : F)

Pin No.	Function	External circuits	Notes
2	H.P.F		Highpass filter
3	AGC		
4	Mono-stable multi-vibrator 1		
5 6	Antenna switching outputs		Pin 6 is for MAIN, pin 5 is for SUB.
7	GND		
8	VCC		

Continued on next page.

## LA1061M

Continued from preceding page.

Unit (resistance :  $\Omega$ , capacitance : F)

Pin No.	Function	External circuits	Notes
9	AGC Voltage output		
10	Mono-stable multi-vibrator 3		<p>The LA1061M counts antenna switches for the time interval generated by multi-vibrator 2. The internal D/A converter outputs a current on pin 11, which is converted to a voltage by the resistor connected to this pin. If this voltage exceeds a certain value, that is, the switching frequency is too high, multi-vibrator 3 operates to hold the antenna switching outputs at Main for the time set by multi-vibrator 3.</p>
11	D/A converter		
12	Mono-stable multi-vibrator 2		
13	Weak signal comparator		The threshold level is set at approximately 2V.
14	Strong signal comparator		The threshold level is set at approximately 1V.

# LA1061M

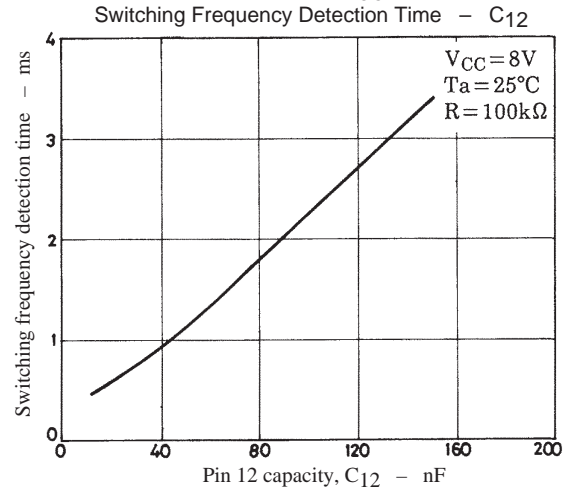
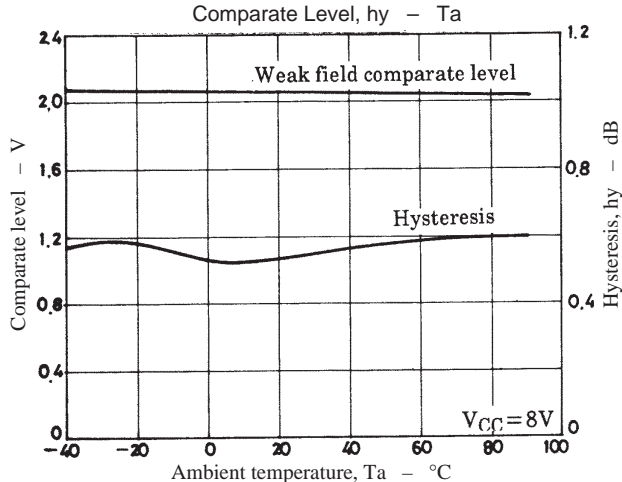
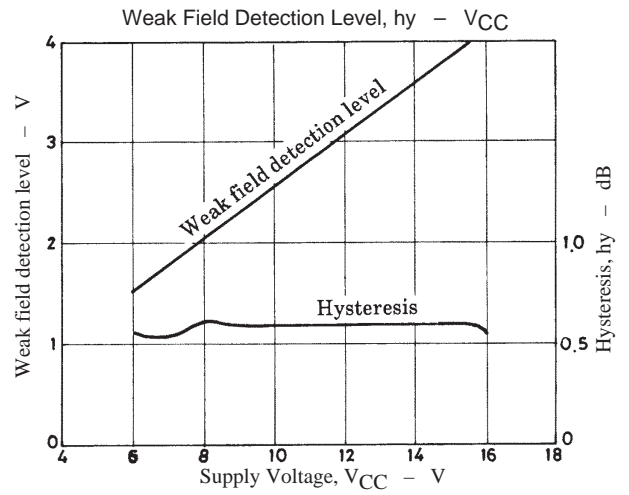
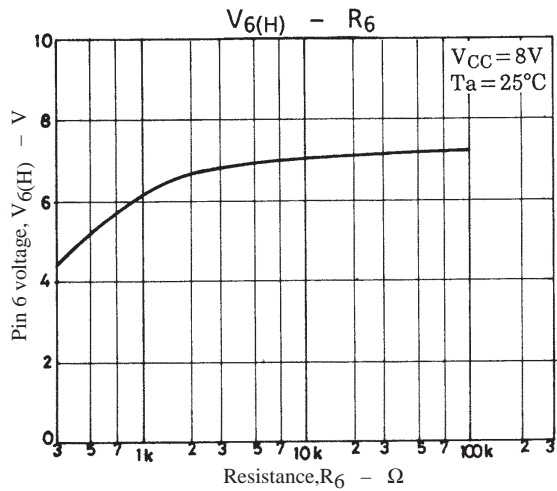
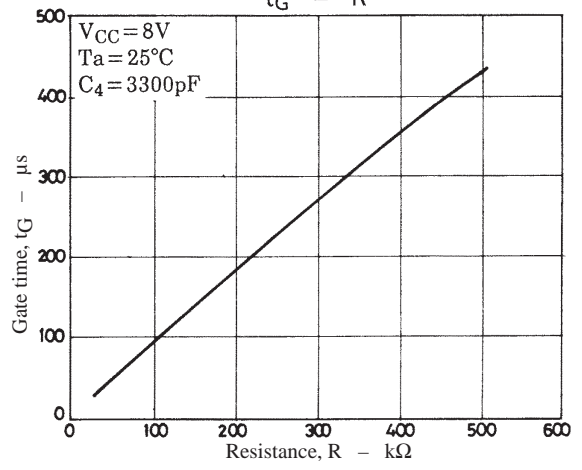
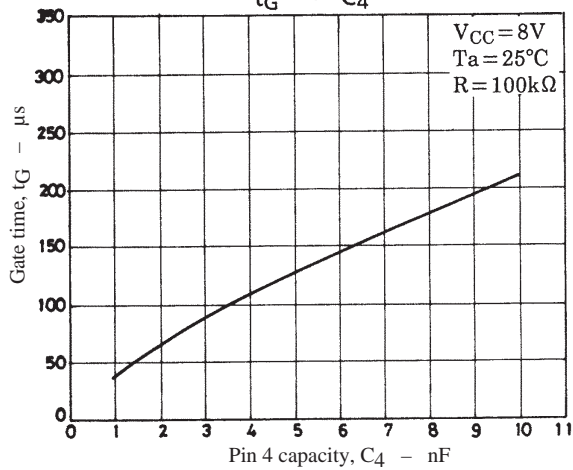
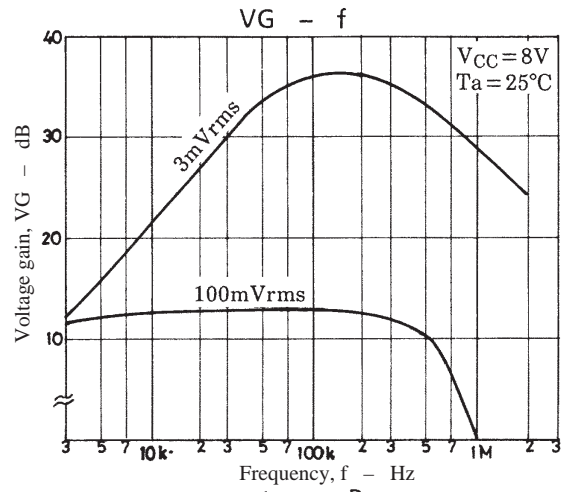
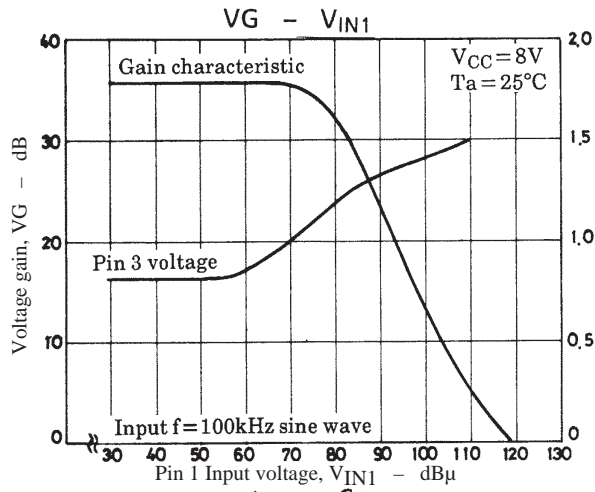

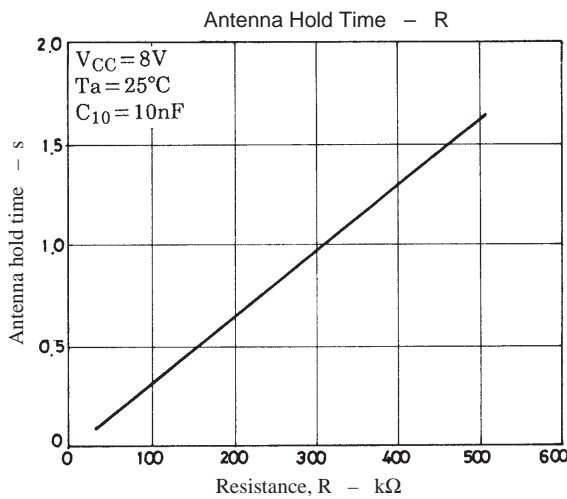
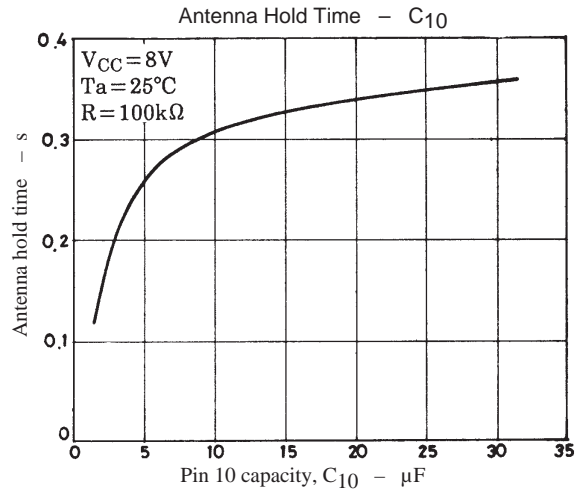
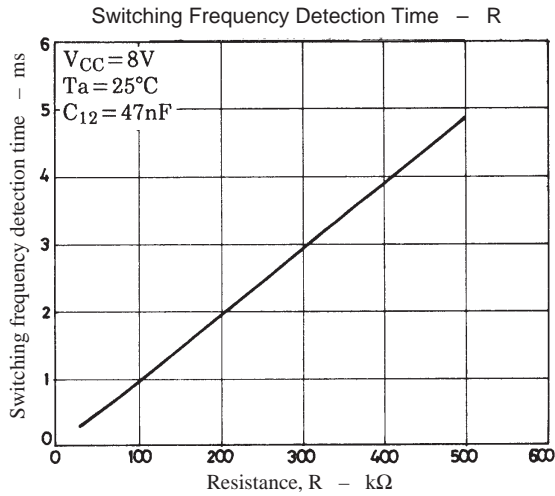

■ No products described or contained herein are intended for use in surgical implants, life-support systems, aerospace equipment, nuclear power control systems, vehicles, disaster/crime-prevention equipment and the like, the failure of which may directly or indirectly cause injury, death or property loss.

■ Anyone purchasing any products described or contained herein for an above-mentioned use shall:

- ① Accept full responsibility and indemnify and defend SANYO ELECTRIC CO., LTD., its affiliates, subsidiaries and distributors and all their officers and employees, jointly and severally, against any and all claims and litigation and all damages, cost and expenses associated with such use:
- ② Not impose any responsibility for any fault or negligence which may be cited in any such claim or litigation on SANYO ELECTRIC CO., LTD., its affiliates, subsidiaries and distributors or any of their officers and employees jointly or severally.

■ Information (including circuit diagrams and circuit parameters) herein is for example only; it is not guaranteed for volume production. SANYO believes information herein is accurate and reliable, but no guarantees are made or implied regarding its use or any infringements of intellectual property rights or other rights of third parties.

This catalog provides information as of August, 1997. Specifications and information herein are subject to change without notice.